

SOFTSTARTER TYPE PSTX

Fieldbus communication

Modbus RTU



PREPARED 2021-03-12	STATUS Approved	SECURITY LEVEL Public		
RELEASED 2021-07-27	DOCUMENT KIND Manual			
OWNING ORGANIZATION Motor Starting & Safety Softstarters	DOCUMENT ID. 1SFC132086M0201	REV. F	LANG. en	PAGE 1/32

Contents

- 1. Modbus RTU 3**
 - 1.1. Software compatibility 4
 - 1.2. Modbus Interface..... 4
 - 1.3. Modbus Addressing5
 - 1.3.1. Protocol Address5
 - 1.3.2. Modicon Address.....5
 - 1.3.3. Translating Modicon address to protocol address5
- 2. PSTX Data 6**
 - 2.1. Digital input telegram 6
 - 2.2. Programmable Digital Inputs.....7
 - 2.3. Analog input telegram..... 8
 - 2.4. Programmable Analog Inputs 9
 - 2.5. Digital output telegram.....10
 - 2.6. Analog output telegram12
- 3. Modbus RTU - A set-up example12**
 - 3.1. Softstarter PSTX Modbus RTU communication12
 - 3.2. Settings.....12
 - 3.3. Read binary input telegram.....13
 - 3.4. Write binary output telegram14
 - 3.5. Read analog input telegram15
 - 3.6. Write analog input telegram16
- 4. Fieldbus Tasks 17**
 - 4.1. FBT Control Word 17
 - 4.2. Task ID 17
 - 4.3. Response ID 17
 - 4.4. Error codes18
 - 4.5. Request parameter value, lower word18
 - 4.5.1. Arguments18
 - 4.5.2. Return Value18
 - 4.6. Change parameter value18
 - 4.6.1. Arguments18
 - 4.6.2. Return Value18
 - 4.7. Set date and time19
 - 4.7.1. Arguments19
 - 4.7.2. Return Value19
 - 4.8. Request parameter value, upper word.....19
 - 4.8.1. Arguments19
 - 4.8.2. Return Value19
 - 4.9. Parameter numbers and values..... 20
 - 4.9.1. Negative values..... 20
- 5. Example application with Automation Builder21**
 - 5.1. Create a new project in Automation Builder21
 - 5.2. Add Modbus RTU master to project.....22
 - 5.3. Build a START-STOP program.....23
 - 5.4. Connect to PLC using TCP/IP30
 - 5.5. Build and run the PLC demo program.....31
- 6. Contact us32**

STATUS	SECURITY LEVEL	DOCUMENT ID.	REV.	LANG.	PAGE
Approved	Public	1SFC132086M0201	F	en	2/32

1. Modbus RTU

Modbus is a master-slave protocol and only one device can transmit on the line at any time. The master (which in most cases is a PLC) manages the exchanges and only it can take the initiative. It interrogates each of the slaves in succession and no slave can send a message unless it is invited to do so. The master repeats the question when there is an incorrect exchange and declares the interrogated slave absent if no response is received within a given time period. If a slave does not understand a message, it sends an exception response to the master who may or may not repeat the request.

The Modbus protocol is a fieldbus protocol that provides full control and status information of the softstarter, reading as well as writing of parameters. Through the fieldbus it is possible to start and stop the motor, read out currents and frequency, get information about protections, warnings, faults and much more.

See chapter 8 in the Installation and commissioning manual, document 1SFC132081M0201, for fieldbus related settings.

Before the Modbus RTU can be taken in operation following parameters must be set in the softstarter:

- Parameter 12.2 FB interface connector set to **Anybus**
- Parameter 12.3 Fieldbus control set to **On** (This parameter can be set to **Off** if the fieldbus interface is only used to monitor the softstarter)
- Parameter 12.9 FB baud rate set to a value matching existing Modbus network (supported baud rates are 1200, 2400, 4800, 9600, 19200, 38400, 57600, 76800 and 115200 Baud)
- Parameter 12.10 FB parity set to a value matching existing Modbus network
- Parameter 12.4 Fieldbus address set to an available Modbus slave id. In the examples (section 5) the fieldbus address is set to 47, but this parameter can be set to any value between 1-247.



Information

After changing any of the communication parameters it is needed to perform a power cycle of the device for the parameter values to be taken into effect. Or another way for a communication parameter value change to be taken into effect is to set parameter 12.2 FB interface connector to “None” and then set it back to “Anybus”.

If there is no message passed between the PSTX softstarter and the Anybus module for more than the configured fieldbus failure timeout time (parameter 19.12), the PSTX softstarter will trip on fieldbus communication failure protection (P1E00) and with the default configuration the motor will be stopped. If the communication system is setup in such a way that commands/requests are not continuously passed between the PLC and softstarter, this protection function should be disabled. The parameter 19.4 (Fieldbus failure op) can then be set to “Off”.

STATUS	SECURITY LEVEL	DOCUMENT ID.	REV.	LANG.	PAGE
Approved	Public	1SFC132086M0201	F	en	3/32



Caution!

The motor may start unexpectedly if there is a start signal present when doing any of the actions listed below.

- Switching from one type of control to another (fieldbus control/hardwire control)
- Reset all Settings



Information

When fastening the module into the com1 port, make sure that the module is properly aligned in the socket prior to applying any force. Rough handling and/or excessive force in combination with misalignment may cause mechanical damage to the module and/or the com1 and socket.

1.1. Software compatibility

Modbus RTU is supported from PSTX_CB v1.34.6.

1.2. Modbus Interface

The Modbus interface is galvanically isolated and provides both RS-232 and RS-485.

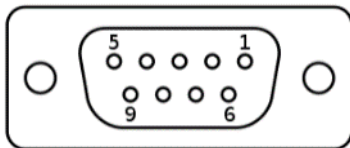

Pin	Direction	Signal	Comment
Housing	-	PE	Protective Earth
1	-	GND	Bus polarization, grounded (isolated)
2	-	-	-
3	Input	PMC	Connect to pin #2 for RS-232 operation. Leave unconnected for RS-485 operation.
4	-	-	-
5	Bidirectional	B-Line	RS-485 B-Line
6	-	-	-
7	Input	Rx	RS-232 Data Receive
8	Output	Tx	RS-232 Data Transmit
9	Bidirectional	A-Line	RS-485 A-Line

1.3. Modbus Addressing

When talking about Modbus addressing, there is often a misunderstanding about what an address really is. This section will try to clarify the conventions in this document.

1.3.1. Protocol Address

The Modbus standard specification uses one kind of address, a two-byte unsigned integer (0-65535).

This is the address that is actually transmitted to the device.

1.3.2. Modicon Address

Modbus was originally developed by Modicon and the notation used then is still often used today, though considered obsolete by present standards.

The Modicon notation combines two pieces of information in a single number:

1. The register type
2. The register number

A register number offset defines the type and makes it possible to translate between the two types of addresses.

Table 1 Register types and ranges

Prefix	Register Type	Range
0x	Coil	00001-00001
1x	Discrete Input	10001-19999
3x	Input Register	30001-39999
4x	Holding Register	40001-49999

1.3.3. Translating Modicon address to protocol address

An example:

Modicon address 40002 selects the holding register at protocol address 0001 (40002 – 40001 = 1). The protocol address 0001 will be transmitted in the message packet.

2. PSTX Data

2.1. Digital input telegram

To PLC from the softstarter. The input data is updated every 20 ms.

Use Modbus function code 02, Read Input Status.

Protocol Address	Modicon Address	Bit	Data	Description
0000h	10001	0	Auto Mode status ¹	0 = softstarter control from fieldbus not allowed
0001h	10002	1	Event status	0 = No active fault/warning/protection
0002h	10003	2	Ready to start	0 = A start will probably cause a fault, 1 = A start will probably not cause a fault
0003h	10004	3	FBT Response 0	See Fieldbus Tasks
0004h	10005	4	FBT Response 1	See Fieldbus Tasks
0005h	10006	5	FBT Toggle Bit	See Fieldbus Tasks
0006h	10007	6	Programmable Digital Input 1	Function of programmable digital input, see section 4.2
0007h	10008	7	Programmable Digital Input 2	
0008h	10009	8	Programmable Digital Input 3	
0009h	10010	9	Programmable Digital Input 4	
000Ah	10011	10	Programmable Digital Input 5	
000Bh	10012	11	Programmable Digital Input 6	
000Ch	10013	12	Programmable Digital Input 7	
000Dh	10014	13	Programmable Digital Input 8	
000Eh	10015	14	Programmable Digital Input 9	
000Fh	10016	15	Programmable Digital Input 10	

¹⁾ Auto mode reflects the control state of the Softstarter. This is affected by a combination of:

- The Auto mode input signal from the PLC (Digital output telegram).
- The state of the Local/Remote switch on the HMI.
- The parameter "Fieldbus control".
- The digital input "Fieldbus disable".

2.2. Programmable Digital Inputs

The functions of the programmable Digital inputs are controlled by the parameters Fieldbus DI 1 through Fieldbus DI 10. The following functions are available for selection:

Function	Data
None	Value is set to 0.
Start feedback	Status of Start signal.
Stop feedback	Status of Stop signal.
Fault reset feedback	Status of Reset signal.
Slow speed reverse feedback	Status of Slow speed reverse signal.
Slow speed forward feedback	Status of Slow speed forward signal.
Start 1 feedback	Status of Start 1 signal.
Start 2 feedback	Status of Start 2 signal.
Start 3 feedback	Status of Start 3 signal.
Motor heating feedback	Status Motor heating signal.
User defined feedback	Status of User defined protection signal.
Stand still brake feedback	Status of Stand still brake signal.
Emergency mode feedback	Status of Emergency mode signal.
Start reverse feedback	Status of Start reverse signal.
Run status	1 = Indicates when the softstarter gives voltage to the motor.
TOR status	Top of Ramp. 1 = Indicates that motor runs on full voltage.
Line	Line or Inside Delta Connection; 0 = Line, 1 = Delta.
Phase sequence	0 = L1, L2, L3; 1 = L1, L3, L2.
Event group 0 status	0 = No active events present in group 0.
Event group 1 status	0 = No active events present in group 1.
Event group 2 status	0 = No active events present in group 2.
Event group 3 status	0 = No active events present in group 3.
Event group 4 status	0 = No active events present in group 4.
Event group 5 status	0 = No active events present in group 5.
Event group 6 status	0 = No active events present in group 6.
Sequence 1 Run status	Run status of sequence connected motor 1.
Sequence 2 Run status	Run status of sequence connected motor 2.
Sequence 3 Run status	Run status of sequence connected motor 3.
Sequence 1 TOR status	Top of Ramp status of sequence connected motor 1.
Sequence 2 TOR status	Top of Ramp status of sequence connected motor 2.
Sequence 3 TOR status	Top of Ramp status of sequence connected motor 3.
Run reverse status	1 = Indicates when the softstarter gives voltage to the motor after a reverse start.
Enable status	Status of Enable signal.
Digital In0 status	Status of internal digital input In0.

Function	Data
Digital In1 status	Status of internal digital input In1.
Digital In2 status	Status of internal digital input In2.
Local control status	0 = Remote control, 1 = Local control (HMI).
Cancel brake feedback	Status of Cancel brake signal.
Pump cleaning auto status	Status of automatic pump cleaning.
Pump cleaning forward status	Status of forward pump cleaning.
Pump cleaning backward status	Status of reverse pump cleaning.
External digital 1DI0 status	Status of external digital input 1DI0.
External digital 1DI1 status	Status of external digital input 1DI1.
External digital 1DI2 status	Status of external digital input 1DI2.
External digital 1DI3 status	Status of external digital input 1DI3.
External digital 1DI4 status	Status of external digital input 1DI4.
External digital 2DI5 status	Status of external digital input 2DI5.
External digital 2DI6 status	Status of external digital input 2DI6.
External digital 2DI7 status	Status of external digital input 2DI7.
HW DI Start status	Status of the hard wire internal digital input Start.
HW DI Stop status	Status of the hard wire internal digital input Stop.
Ready to start (line contactor)	Same conditions as the Ready To Start bit except that the incoming three phase voltage condition is excluded. The bit can be used when a line contactor is connected.

2.3. Analog input telegram

To PLC from the softstarter.

All analog data is represented as 16-bit values. The input data is updated every 20 ms.

Use Modbus function code 04, Read Input Registers.

A protocol for Fieldbus tasks is used to read and write parameters. It is applicable for all Fieldbuses.

Protocol Address	Modicon Address	Data	Representation
0001h	30002	FBT Return Value	See Fieldbus Tasks
0002h	30003	Programmable Analog Input 1	Function of programmable analog input, see section 4.4
0003h	30004	Programmable Analog Input 2	
0004h	30005	Programmable Analog Input 3	
0005h	30006	Programmable Analog Input 4	
0006h	30007	Programmable Analog Input 5	
0007h	30008	Programmable Analog Input 6	
0008h	30009	Programmable Analog Input 7	
0009h	30010	Programmable Analog Input 8	
000Ah	30011	Programmable Analog Input 9	
000Bh	30012	Programmable Analog Input 10	

2.4. Programmable Analog Inputs

The functions of the programmable analog inputs are controlled by the parameters Fieldbus AI 1 through Fieldbus AI 10. The following functions are available for selection:

Function	Representation
None	Value is set to 0
Phase L1 current ¹	Value = 1000 ⇒ 100A
Phase L2 current ¹	Value = 1000 ⇒ 100A
Phase L3 current ¹	Value = 1000 ⇒ 100A
Active power (hp)	Value = 1000 ⇒ 10hp
Active power	Value = 1000 ⇒ 10kW
Apparent power	Value = 1000 ⇒ 10kVA
Mains voltage	Value = 1000 ⇒ 100V
Power factor	Value = 100 ⇒ 1 Example: 87 ⇒ 0.87
Motor voltage	Value = 100 ⇒ 100%
Active energy (resettable)	Value = 1000 ⇒ 10kWh
EOL time to trip	Value = 100 ⇒ 100s Value = 65535 ⇒ No overload Value = 0 ⇒ Trip already occurred
Mains frequency	Value = 1000 ⇒ 100Hz
Max phase current ¹	Value = 1000 ⇒ 100A
Motor current	Value = 1000 ⇒ 100A
Motor run time (resettable)	Value = 100 ⇒ 1000h
Motor temperature	Value = 100 ⇒ 100°C
Motor temperature percent	Value = 100 ⇒ 100%
Number of starts (resettable)	Value = 1 ⇒ 100
Phase sequence	Value = 0 ⇒ L1->L2->L3 Value = 1 ⇒ L1->L3->L2 Value = 2 ⇒ No sequence detected
PT100 temperature	Value = n ⇒ n/10 – 50°C Example: 750 ⇒ 25°C
PTC resistance	Value = 100 ⇒ 100Ω
Reactive energy (resettable)	Value = 1000 ⇒ 10kVARh
Reactive power	Value = 1000 ⇒ 100VAR
Remaining time to start	Value = 100 ⇒ 100s
Thyristor temperature	Value = 100 ⇒ 100°C
Thyristor temperature percent	Value = 100 ⇒ 100%
EOL time to cool	Value = 100 ⇒ 100s
Top event code	Value = 1000 ⇒ 1000
Motor current in percent of IE.	Value = 100 ⇒ 100%
Thyristor run time (resettable)	Value = 1 ⇒ 10h

Function	Representation
Motor connection	Value = 0 ⇒ auto Value = 1 ⇒ In-line Value = 2 ⇒ Inside delta – UI Value = 3 ⇒ Inside delta – IU Value = 4 ⇒ 2-phase L1 shorted Value = 5 ⇒ 2-phase L2 shorted Value = 6 ⇒ 2-phase L3 shorted
Phase L1 current high range ²	Value = 100 ⇒ 100A
Phase L2 current high range ²	Value = 100 ⇒ 100A
Phase L3 current high range ²	Value = 100 ⇒ 100A
Active power (hp) high range ²	Value = 100 ⇒ 100hp
Active power high range ²	Value = 100 ⇒ 100kW
Apparent power high range ²	Value = 100 ⇒ 100kVA
Reactive power high range ²	Value = 100 ⇒ 100kVAr
Max phase current high range ²	Value = 100 ⇒ 100A
Max motor current high range ²	Value = 100 ⇒ 100A
Active energy high range ²	Value = 1 ⇒ 10000kWh
Reactive energy high range ²	Value = 1 ⇒ 10000kVArh
Number of starts (high precision)	Value = 1 ⇒ 1

¹⁾ Phase current L1, L2 and L3 indicate the current through the softstarter, while the Max phase current is always the line current.

²⁾ High Range alternatives are available for a few signals where there is a possibility for the values to wrap. The values are 16-bit so the maximum value for each signal is 65535. The High Range alternatives have different scaling and will never wrap around but instead have lower precision.

2.5. Digital output telegram

From PLC to the softstarter.

Use Modbus function code 15 (0Fh), Force Multiple Coils.

Protocol Address	Modicon Bit Address	Bit	Data	Description
0000h	1	0	Start	Commence a start when signal is set.
0001h	2	1	Stop	Commence a stop when signal is negated.
0002h	3	2	Fault reset	Reset signal for possible events.
0003h	4	3	Auto mode	This must be set for controlling the motor.
0004h	5	4	Slow speed reverse	Perform slow speed reverse when signal is set.
0005h	6	5	Slow speed forward	Perform slow speed when signal is set.
0006h	7	6	Spare	
0007h	8	7	Start1	Start1 if sequence start.

Protocol Address	Modicon Bit Address	Data	Description
0008h	9	8	Start2 Start2 if sequence start.
0009h	10	9	Start3 Start3 if sequence start.
000Ah	11	10	Motor heating Perform motor heating when signal is set.
000Bh	12	11	Stand still brake Perform stand still brake when signal is set.
000Ch	13	12	Start reverse Commence a reverse start when signal is set.
000Dh	14	13	Spare
000Eh	15	14	Emergency mode Set to "1" to enable emergency mode.
000Fh	16	15	FBT Toggle Bit See Fieldbus Tasks.
0010h	17	16	User defined trip Set to "1" to trigger user defined protection.
0011h	18	17	Switch to remote control Switch to remote control when signal is set (rising edge triggered).
0012h	19	18	Pump Cleaning Automatic Perform automatic pump cleaning when signal is set.
0013h	20	19	Pump Cleaning Forward Perform forward pump cleaning when signal is set.
0014h	21	20	Pump Cleaning Reverse Perform reverse pump cleaning when signal is set.
0015h	22	21	K4 relay command Set "1" to activate the internal K4 output relay. Note that parameter 10.4 K4 function has to be set as "Fieldbus"
0016h	23	22	K5 relay command Set "1" to activate the internal K5 output relay. Note that parameter 10.5 K5 function has to be set as "Fieldbus"
0017h	24	23	K6 relay command Set "1" to activate the internal K6 output relay. Note that parameter 10.6 K6 function has to be set as "Fieldbus"
0018h	25	24	1DO0 relay command Set "1" to activate the external 1DO0 output relay. Note that parameter 11.9 1DO0 function has to be set as "Fieldbus"
0019h	26	25	1DO1 relay command Set "1" to activate the external 1DO1 output relay. Note that parameter 11.10 1DO1 function has to be set as "Fieldbus"
001Ah	27	26	2DO2 relay command Set "1" to activate the external 2DO2 output relay. Note that parameter 11.11 2DO2 function has to be set as "Fieldbus"
001Bh	28	27	2DO3 relay command Set "1" to activate the external 2DO3 output relay. Note that parameter 11.12 2DO3 function has to be set as "Fieldbus"
001Ch	29	28	Refresh parameters Restart fieldbus interface to refresh communication parameters
001Dh	30	29	Spare
001Eh	31	30	Spare
001Fh	32	31	Spare

2.6. Analog output telegram

From PLC to the softstarter.

All analog data is represented as 16-bit values.

Use Modbus function code 16 (10h), Write Multiple Registers.

Protocol Address	Modicon Address	Data	Representation
0002h	40003	FBT Control Word	This register is used to read parameters (see fieldbus tasks).
0003h	40004	Fieldbus AO 1 (FBT Argument 2 or Internal analog output)	Parameter 12.37 Fieldbus AO1 decides the use of this register. If set as "FBT Argument 2", it is used to write parameters and set time (see fieldbus tasks). If set as "Internal analog output" this value of this register controls the internal analog output. Note that parameter 10.8 AO type needs to be set as "Fieldbus [%]".
0004h	40005	Fieldbus AO 2 (FBT Argument 3 or External analog output)	Parameter 12.38 Fieldbus AO2 decides the use of this register. If set as "FBT Argument 3", it is used to write parameters and set time (see fieldbus tasks). If set as "External analog output" this value of this register controls the external analog output. Note that parameter 11.14 1AO0 type needs to be set as "Fieldbus [%]".

3. Modbus RTU - A set-up example

3.1. Softstarter PSTX Modbus RTU communication

This document describes an application example between a Modbus RTU master (PLC CPU, PC, etc.) and the ABB softstarter PSTX equipped with an Anybus CompactCom Modbus-RTU module. In this example the softstarter address is 47.

Please always use the actual softstarter manuals. In this particular example following documents has been used:

Softstarter PSTX Installation and commissioning manual, document 1SFC132081M0201

3.2. Settings

1. **Set the softstarter address and field bus communication:**

Change the address of the softstarter to 47 (Fieldbus Address) and enable fieldbus control (Fieldbus control = On).

2. **Set the communication parameters:**

Change the communication parameters baud rate, parity, stop bits to match the Modbus network settings.

3. **Select the Anybus CompactCom interface:**

The previous changes are taken in effect when the fieldbus interface is changed. Change parameter FB interface connector to Anybus.

STATUS	SECURITY LEVEL	DOCUMENT ID.	REV.	LANG.	PAGE
Approved	Public	1SFC132086M0201	F	en	12/32

3.3. Read binary input telegram

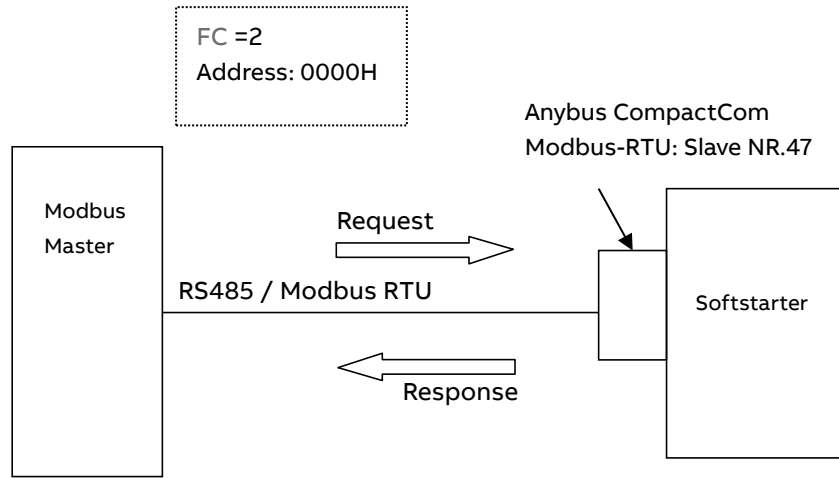

E.g.: Read 16 bit starting at the address: 0000H

Request:

2F 02 00 00 00 10 7F 88



Slave 47
 FC = 02
 16 bit
 16 bit
 CRC

Response:

2F 02 02 00 00 10 51 BE



Slave 47
 FC = 02
 16 bit
 16 bit
 CRC

3.4. Write binary output telegram

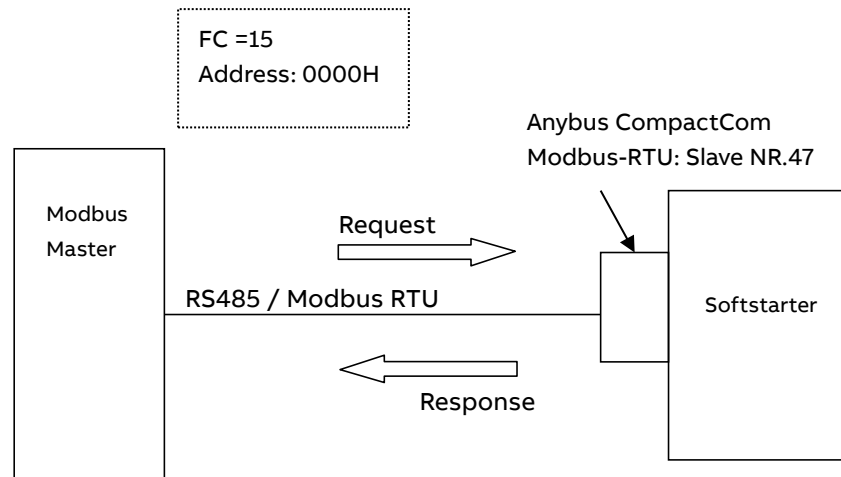

E.g.: Write 16 bit starting at the address: 0000H

Request:

2F 0F 00 00 00 10 02 00 00 37 81



Slave 47	FC = 15	Address	16 bit	2 byte	Output	CRC
----------	---------	---------	--------	--------	--------	-----

Response:

2F 0F 00 00 00 10 02 52 49



Slave 47	FC = 15	Address	16 bit	2 byte	CRC
----------	---------	---------	--------	--------	-----

3.5. Read analog input telegram

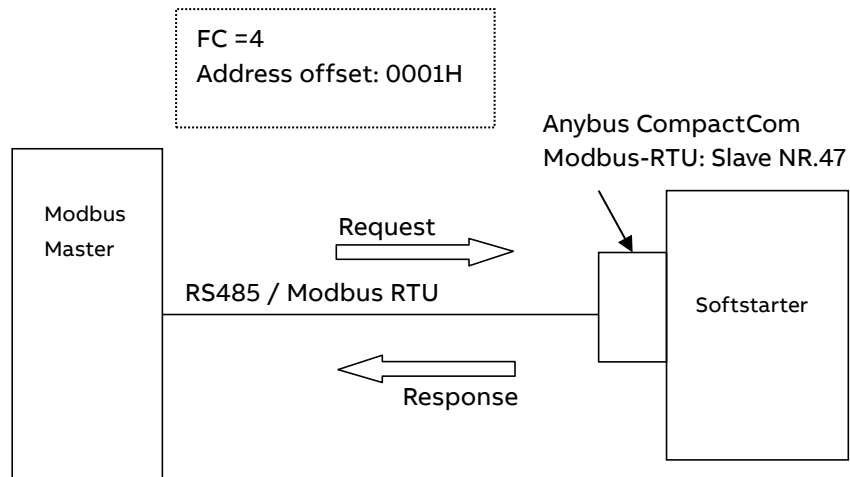

E.g.: Read analog output words 2 & 3. Phase L1 current and Phase L2 current with default settings.

Request:

2F 04 00 02 00 02 D6 45



Slave 47
 FC =4
 Address
 2 words
 CRC

Response:

2F 04 04 00 00 00 00 35 86



Slave 47
 FC = 04
 4 Byte
 W0
 W1
 CRC

W0: Phase L1 current

W1: Phase L2 current

STATUS	SECURITY LEVEL	DOCUMENT ID.	REV.	LANG.	PAGE
Approved	Public	1SFC132086M0201	F	en	15/32

3.6. Write analog input telegram

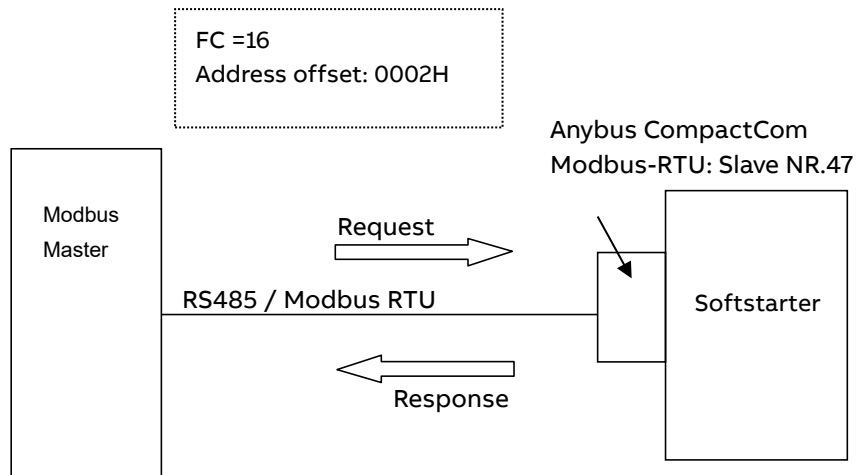

E.g.: Write analog output words 1 & 2. FBT Control Word and FBT Argument 2.

Request:

2F 10 00 02 00 02 D6 45



Slave 47
 FC = 4
 Address
 2 words
 CRC

Response:

2F 10 00 02 00 02 E6 46



Slave 47
 FC =16
 Address
 2 words
 CRC

W0: FBT Control Word

W1: FBT Argument 2

STATUS	SECURITY LEVEL	DOCUMENT ID.	REV.	LANG.	PAGE
Approved	Public	1SFC132086M0201	F	en	16/32

4. Fieldbus Tasks

By using Fieldbus Tasks it is possible to read/write parameters and set the real-time clock.

Which task to execute is selected by filling in the FBT Control Word. There are three signals for arguments to the task:

FBT Argument 1 is packed together with the Task ID in the FBT Control Word.

There are two additional 16-bit arguments in separate analog output signals, FBT Argument 2 and FBT Argument 3.

To control when the task is executed, the digital output signal FBT Toggle Bit shall be changed. The softstarter will detect the change, execute the task, fill in the return values, and toggle the digital input signal FBT Toggle Bit as acknowledgement. Thus, the return values must be disregarded if the two toggle bits have different value.

4.1. FBT Control Word

The control word is a 16-bit analog output value sent from the PLC to the softstarter. It consists of a Task ID and an 11-bit argument packed together.

15	14, 13, 12,	11	10, 9, 8, 7, 6, 5, 4, 3, 2, 1, 0
-	Task ID	-	Argument 1

4.2. Task ID

The task identifier controls which function should be performed.

Task ID	Task	Response ID	
		Positive	Negative
0	No task	0	-
1	Request parameter value, lower word	1	2
2	Change parameter value	1	2
3	Set date and time	1	2
4	Request parameter value, upper word	1	2

4.3. Response ID

The response ID is the softstarter response to a task. It tells whether a task was executed successfully. If there was an error, an additional error code is returned in the FBT Return Value analog input. The Response ID is transmitted as two digital input signals, FBT Response 0 and FBT Response 1.

Response ID	FBT Response 1	FBT Response 0	Explanation
0	0	0	No response
1	0	1	Task executed
2	1	0	Task cannot be executed (with error number)
3	1	1	Reserved.

4.4. Error codes

The following error codes are sent when a task cannot be executed.

Error code	Explanation
0	Illegal parameter number
1	Parameter value cannot be changed
3	Lower or upper limit violated
4	Invalid argument
5	No error
6	Invalid task number

4.5. Request parameter value, lower word

This task reads the lower 16 bits of the specified parameter. See chapter 4.9 for parameter number and value scaling information.

4.5.1. Arguments

FBT Argument 1: parameter number.

4.5.2. Return Value

Response ID 1 and parameter value in FBT Return Value on success.

Response ID 2 and error number in FBT Return Value on failure.

4.6. Change parameter value

This task writes a specified value to a parameter. See chapter 4.9 for parameter number and value scaling information.

4.6.1. Arguments

FBT Argument 1: parameter number.

FBT Argument 2: parameter value (lower word)

FBT Argument 3: parameter value (upper word)

4.6.2. Return Value

Response ID 1 on success.

Response ID 2 and error number in FBT Return Value on failure.

4.7. Set date and time

This task updates the real-time clock on the softstarter. The date and time fields have the following limits:

Year: 0-63 (2000-2063)

Month: 1-12

Day: 1-31

Hour:0-23

Minute:0-59

Second:0-59

4.7.1. Arguments

FBT Argument 2: year, month, day and least significant bit of seconds

15	14, 13, 12, 11, 10, 9	8, 7, 6, 5	4, 3, 2, 1, 0
s0	year	month	day

FBT Argument 3: hour, minute, seconds, bit 1-5

15, 14, 13, 12, 11	10, 9, 8, 7, 6, 5	4, 3, 2, 1, 0
Hour	Minute	seconds, bit 1-5

4.7.2. Return Value

Response ID 1 on success.

Response ID 2 and error number in FBT Return Value on failure. In case the supplied time didn't differ from the set time, error code 5 (no error) is used.

4.8. Request parameter value, upper word

This task reads the upper 16 bits of the specified parameter. See chapter 4.9 for parameter number and value scaling information.

4.8.1. Arguments

FBT Argument 1: parameter number.

4.8.2. Return Value

Response ID 1 and parameter value in FBT Return Value on success.

Response ID 2 and error number in FBT Return Value on failure.

STATUS	SECURITY LEVEL	DOCUMENT ID.	REV.	LANG.	PAGE
Approved	Public	1SFC132086M0201	F	en	19/32

4.9. Parameter numbers and values

To access parameters from the fieldbus a unique parameter number is needed, this can be found in document 1SFC132081M0201, Chapter 7.25 Complete parameter list.

Since the parameter values need to be represented as integers on the fieldbus while, the parameter values with greater precision need to be scaled. In document 1SFC132081M0201, Chapter 7.25 Complete parameter list, there is a column specifying the number of decimals for each parameter.

- Parameter values that are read from the fieldbus needs to be divided by $10^{\text{number of decimals}}$.
- Parameters values that are written from the fieldbus needs to be multiplied by $10^{\text{number of decimals}}$.

For example:

The parameter Kick start time has parameter number 24 and 2 decimals. To read this parameter:

1. Set FBT Task ID to 1.
2. Set FBT Argument 1 to 24.
3. Toggle FBT Toggle Bit output and wait for the FBT Toggle Bit input to update.
4. Response ID 1 should now contain value 1, indicating success.
5. FBT Return Value contains the value 50 (this is an example and depends on the actual set value).
6. The return value should be interpreted as $50/10^2 = 0.5s$.

To change the Kick start time parameter to 1s:

1. Set FBT Task ID to 2.
2. Set FBT Argument 1 to 24.
3. Set FBT Argument 2 to $1 \cdot 10^2 = 100$.
4. Set FBT Argument 3 to 0 as $100 \leq 65535$ which means it doesn't require more than 16 bits.
5. Toggle FBT Toggle Bit output and wait for the FBT Toggle Bit input to update.
6. Response ID 1 should now contain value 1, indicating success.

4.9.1. Negative values

Negative values are represented internally using 32-bit two's complement numbers.

Example:

Setting parameter 17.5 PT100 reset temp (parameter number 249) to a value of -25°C:

The two's complement of -25 is $FFFFFFE7_{\text{hex}}$. The upper word is $FFFF_{\text{hex}}$ and the lower $FEE7_{\text{hex}}$, in decimal notation 65535 and 65511.

1. Set FBT Task ID to 2 for Change parameter value.
2. Set FBT Argument 1 to 249 to specify the parameter.
3. Set FBT Argument 2 to 65511 to specify the lower word.
4. Set FBT Argument 3 to 65535 to specify the upper word.

STATUS	SECURITY LEVEL	DOCUMENT ID.	REV.	LANG.	PAGE
Approved	Public	1SFC132086M0201	F	en	20/32

5. Toggle FBT Toggle Bit output and wait for the FBT Toggle Bit input to update.
6. Response ID 1 should now contain value 1, indicating success.

5. Example application with Automation Builder

This section shows a demo about how to start and stop motor by sending commands from fieldbus that is controlled by Programmable logic controller (PLC). We use Automation Builder as an example platform and show the demo about building such communication setting.

5.1. Create a new project in Automation Builder

We perform the following steps in Automation Builder 2.1 for PLC AC500 PM573.

1. Open Automation Builder
2. Select File->New Project->AC500 project->OK
3. Select the correct PLC CPU in Search object name ...-> Add PLC

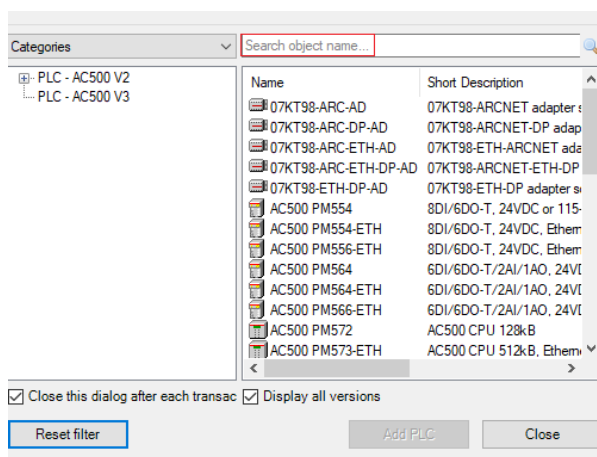

4. Check that the correct device type is selected by double clicking the device name in Devices field. Check that the correct Terminal Base Type is also selected for the tag for Hardware.

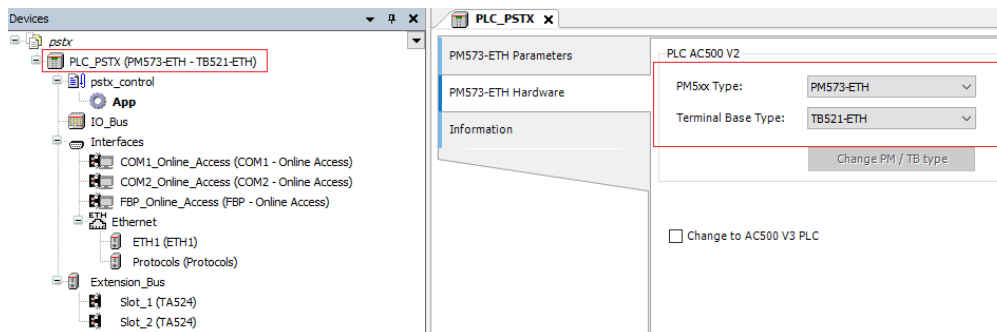

STATUS	SECURITY LEVEL	DOCUMENT ID.	REV.	LANG.	PAGE
Approved	Public	1SFC132086M0201	F	en	21/32

5.2. Add Modbus RTU master to project

1. Right click on one of the comports and select Add object

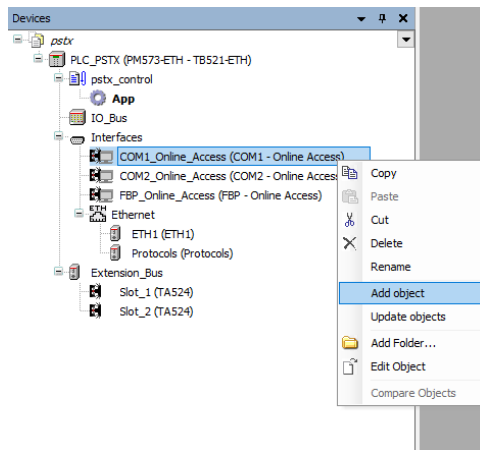

2. Select Modbus and click Replace object

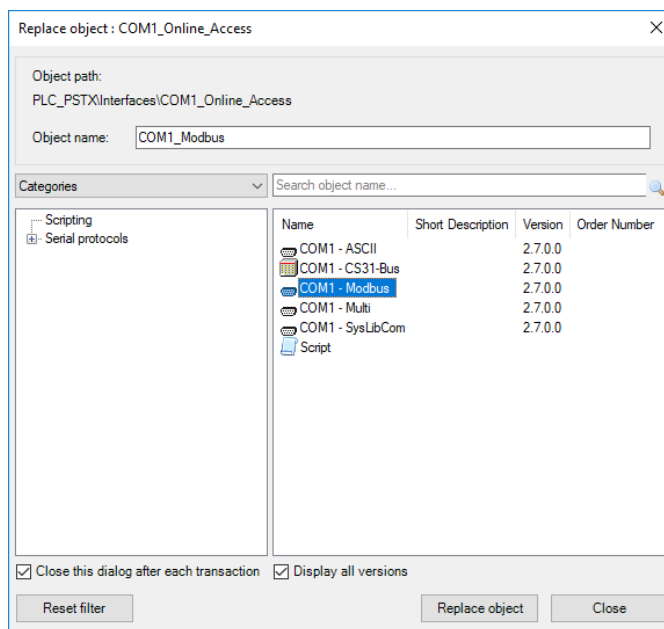

3. Double click interfaces, COM1_Modbus, from the device tree. Set RTS control to Telegram and Operation mode to Client for COM1 – Modbus Parameters in COM1_Modbus

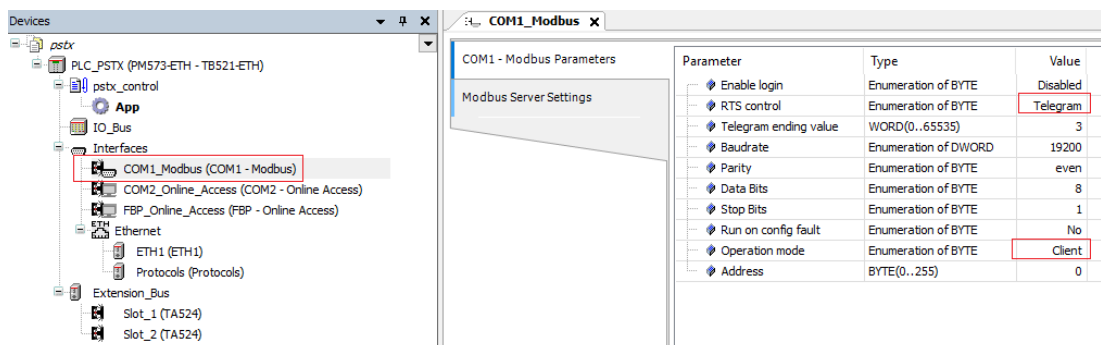

5.3. Build a START-STOP program

We perform the following steps for building our start-stop demo program in CoDeSys.

1. Open CoDeSys by double clicking your application in Devices file in Automation Builder, if it is not opened yet.

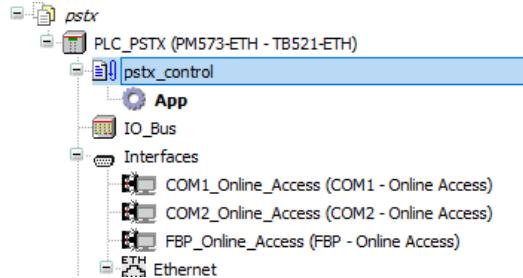

2. Delete the default POU by right click on it and select.

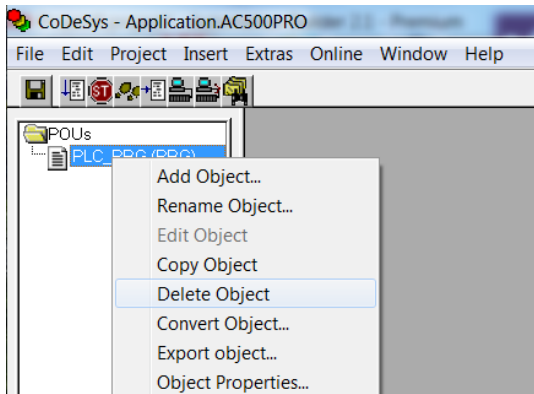

3. We choose to use LD as the language of the POU here by right click POUs -> Add Object... -> Insert Name of the new POU -> Choose "LD" for "Language of the POU" -> OK.

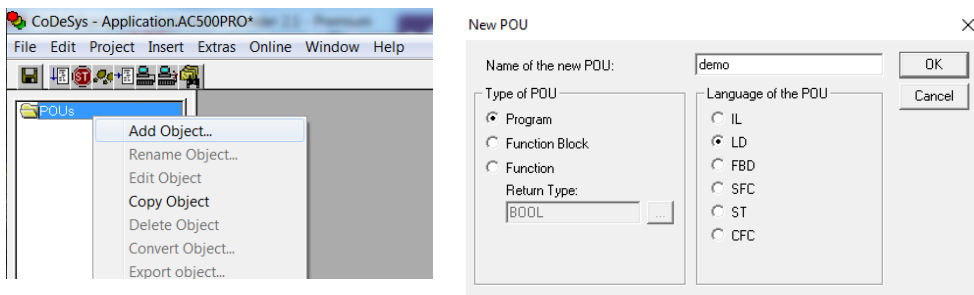

4. Open the newly created POU by double click it and select the first network, create a contact (by CTRL+K) and two coils (by CTRL+L).

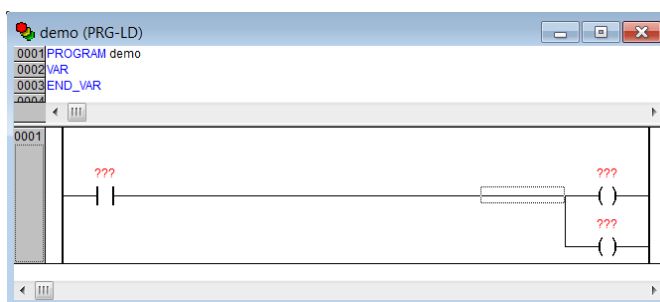

5. Name the contact START by changing the ??? to START, select type BOOL.

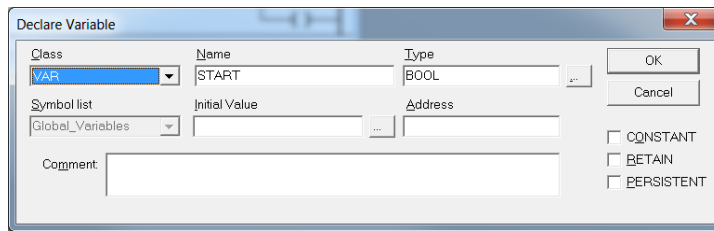

6. Name the coils “BITVAL[1]” and “BITVAL[2]”, set the type to “ARRAY [1..16] OF BOOL”.

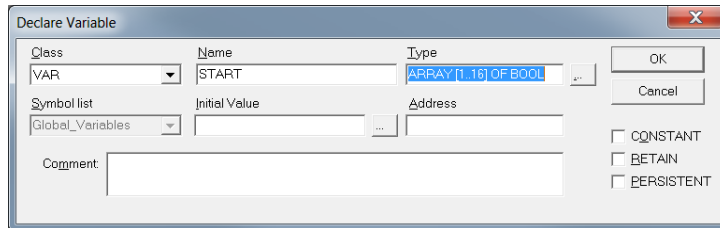

7. Add a second network by CTRL+T and add a single coil (by CTRL+L) named “BITVAL[4]”.

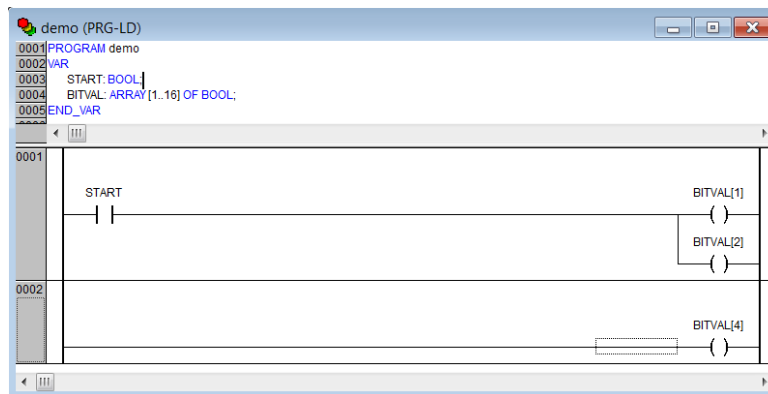

8. Add another network by CTRL+T. Create a function block “BLINK” by CTRL+B and select Standard Function Blocks -> Util.lib -> signals-> BLINK(FB)->Ok.

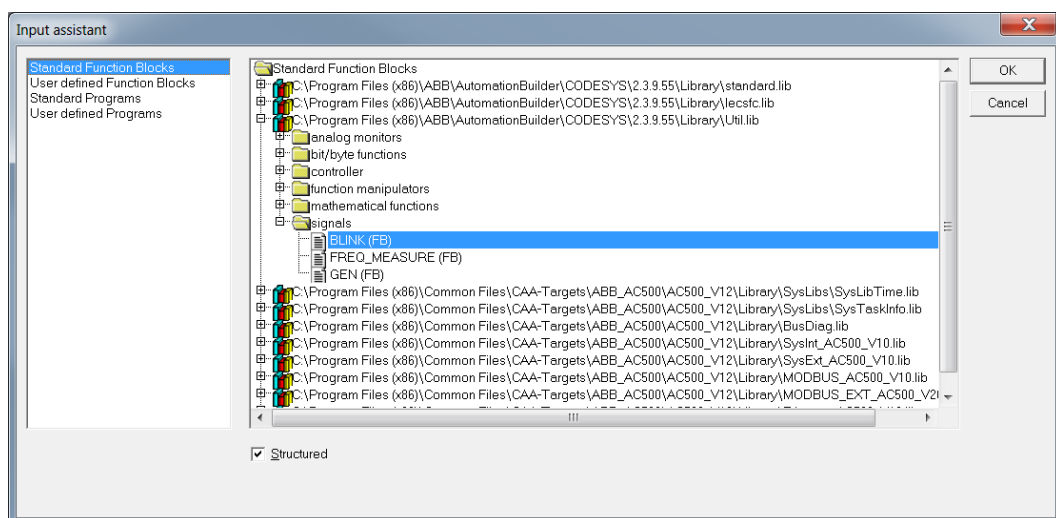

9. We name the BLINK function block as blink. We set t#2ms for TIMELOW and TIMEHIGH.

10. Continue to create a function block “COM_MOD_MAST” by CTRL+B and select Standard Function Blocks -> MODBUS_AC500_V10.LIB -> COM_MOD_MAST(FB) -> OK.

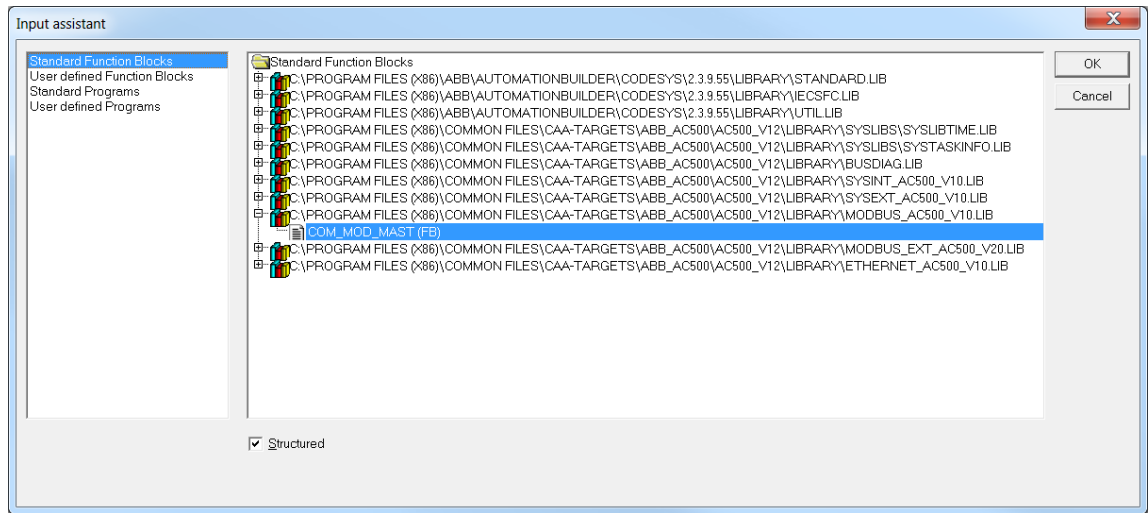

Now, we should have two function blocks in network 0003.

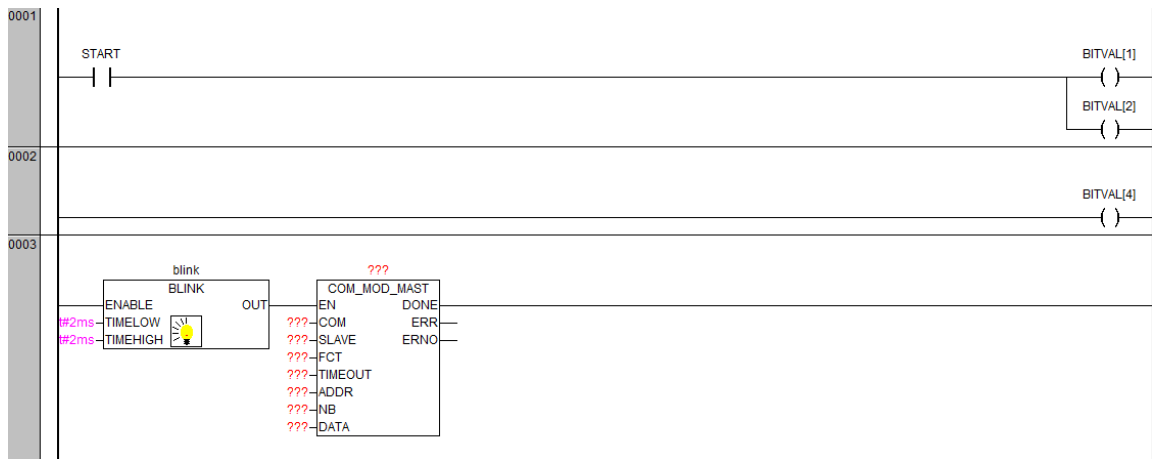

The COM_MOD_MAST is a function block for sending/receiving OpenModbus. Their definition is available from CoDeSys -> Resources -> Library Manager.

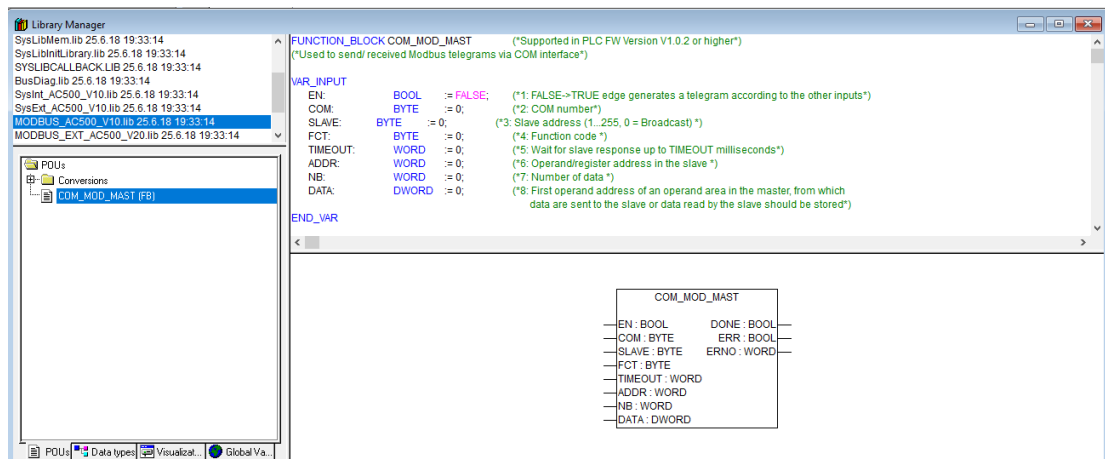

To enable this function block, it is required to send a FALSE->TRUE edge at input EN and therefore we introduce BLINK, which is for creating a flip-flop signal.

11. DATA (the data to send) require DWORD inputs. We can convert data with a box, "ADR".

a) Select the bar in front of DATA.

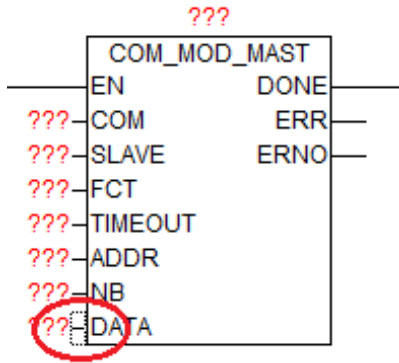

b) Choose Insert-> Insert at Blocks-> Box.

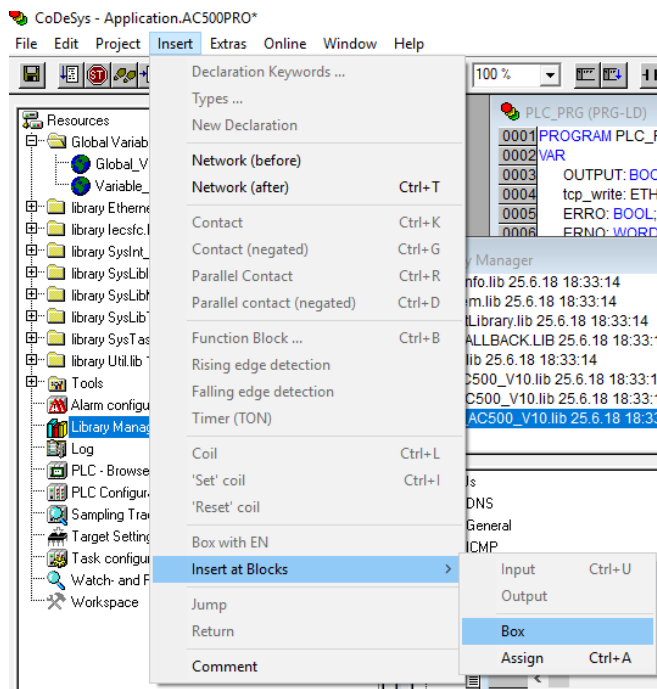

The default box is "AND", change the name to ADR and it will be a ADR box.

12. Set:

- The name of the block to Modbus_write
- COM to 1 or 2 depending on comport used
- Slave to the value of "Fieldbus address" (Parameter 12.4 in PSTX)
- FCT to 15
- TIMEOUT to 100
- ADDR to 0, according to Section 2.5, the first Protocol Address is 0000h.
- NB to 16
- ERR to ERRO (new BOOL variable)
- ERRNO (new WORD variable)

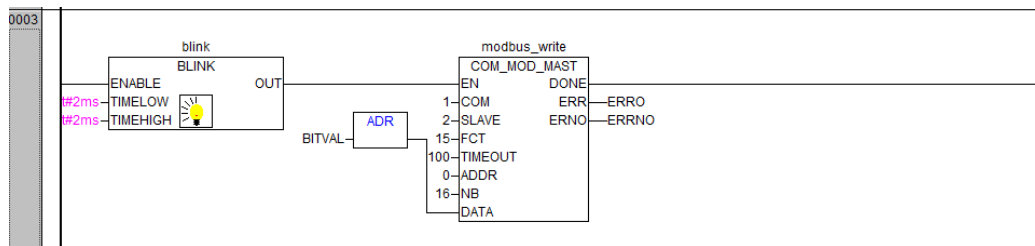

13. Insert a coil named "OUTPUT" in the last network and the LD-program is done.

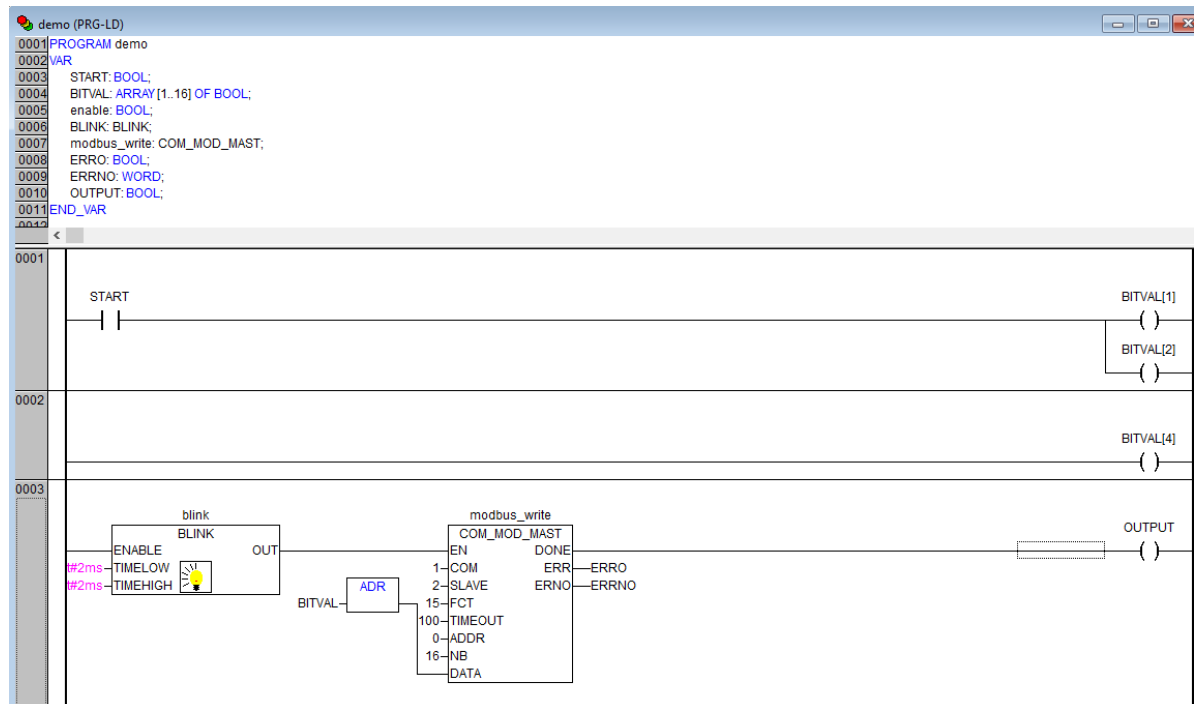

14. Now we want to create one control button for signing the value of “START” from the first network into TRUE. We do this by Visualization -> right click -> Add object -> Write name of the new Visualization as “view” -> OK.

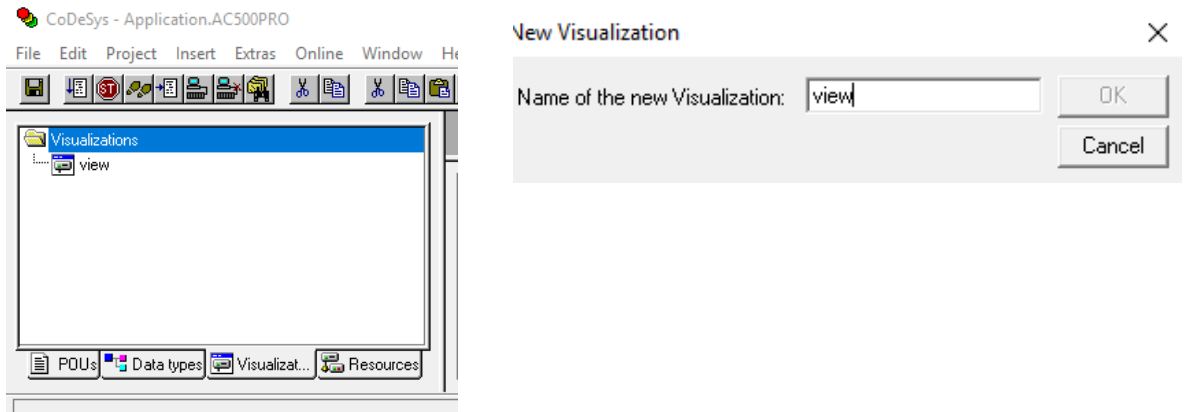

15. We draw a shape as the button  -> double click the shape -> Regular Element Configuration -> Input -> check Toggle variable -> insert “demo.START” ->OK.

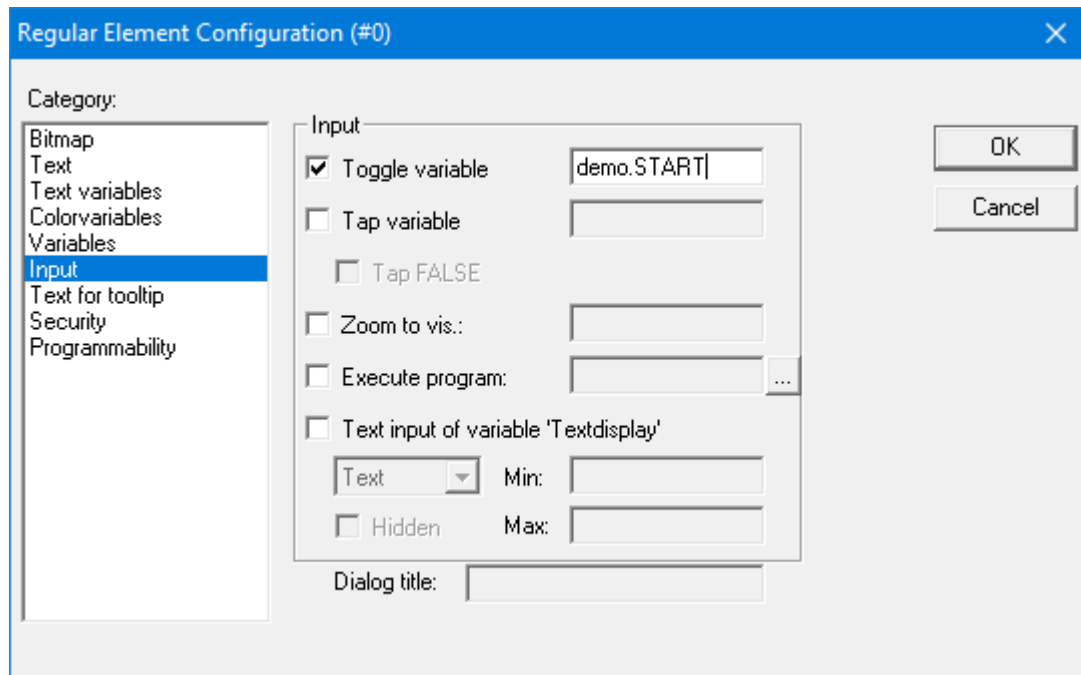

16. We configure this program into task configuration by Resource -> Task configuration -> Right click Task configuration -> Append Task -> Insert t#10ms in Properties in Taskattributes. Then we need to sign our program to this task by right click NewTask-> Append Program Call-> Choose demo(PRG) by clicking the select button in Program Call ->OK.

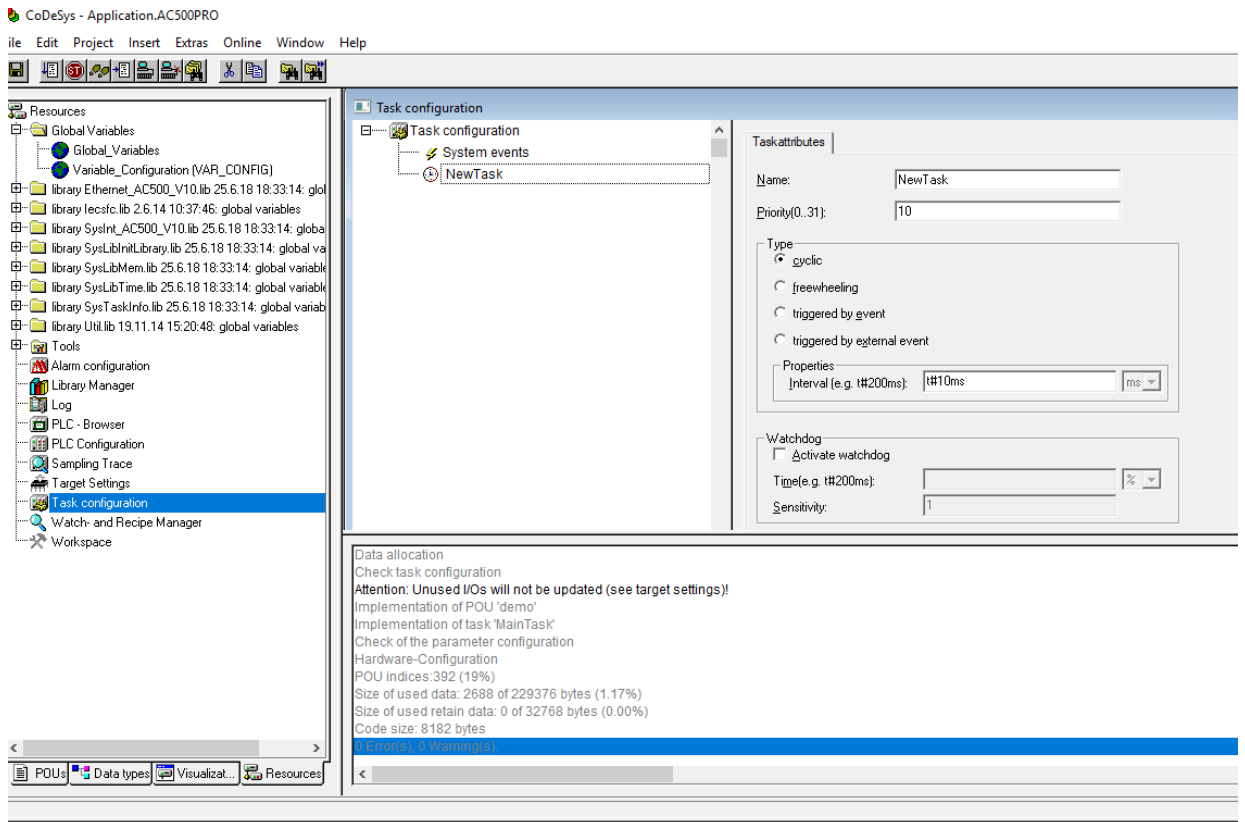

17. Right click on the NewTask and select Append Program Call.

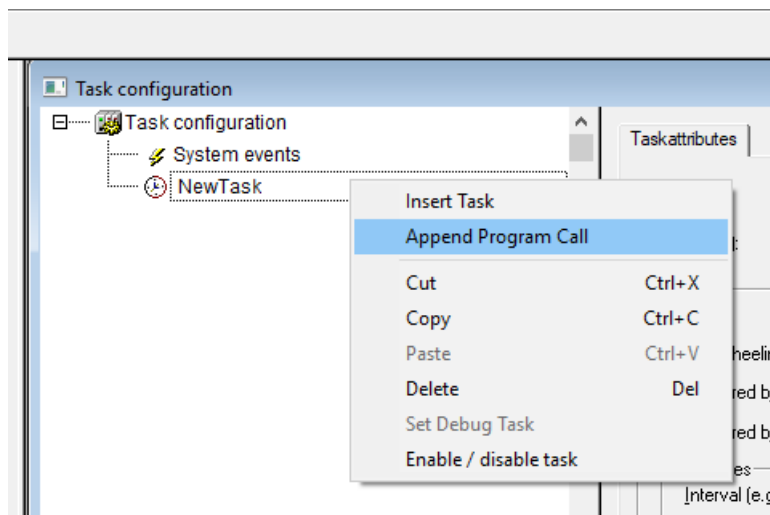

STATUS	SECURITY LEVEL	DOCUMENT ID.	REV.	LANG.	PAGE
Approved	Public	1SFC132086M0201	F	en	29/32

18. Select the demo program call.

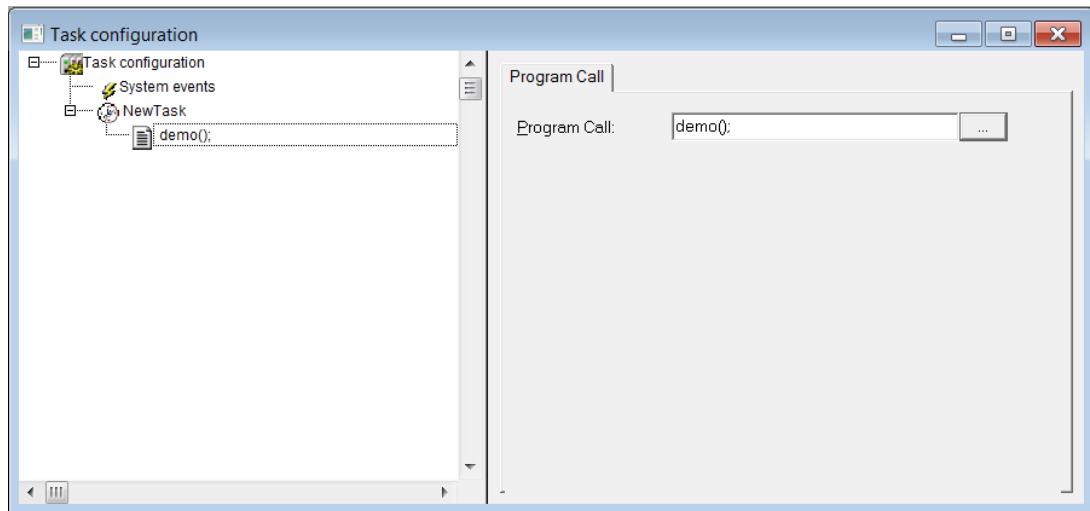

19. Now we can build the project by Project -> Build. Check again if fieldbus is connected correctly. We can then run the program by pressing ALT+F8 and then F5.

5.4. Connect to PLC using TCP/IP

1. Control the IP address for the device is also correct by right click the device name and then chose communication setting. The IP address should be the address of PLC CPU device.

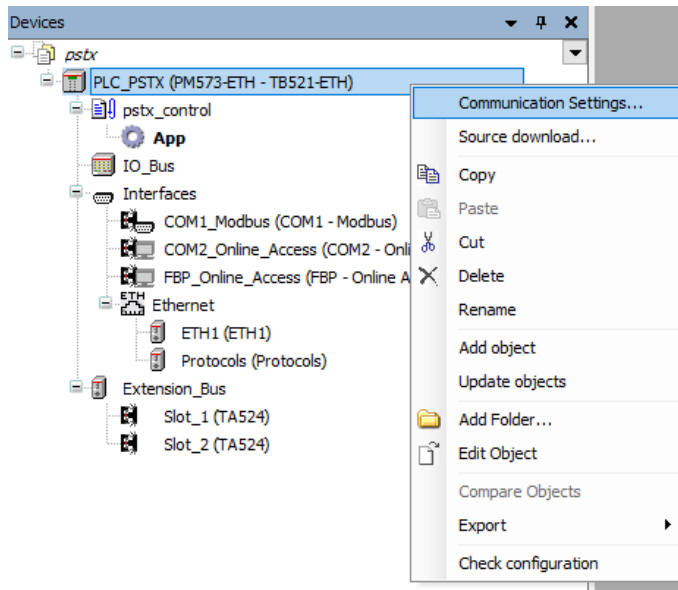

2. Control that the IP address for PC and the PLC is in the same network but not the same IP address. This can be checked by using through Ethernet Properties.
3. Click the icon “Login”, for building the configuration and checking if configuration is correct.
4. If the configuration is correct, a program for building PLC should be opened in the PLC environment, CoDeSys. Automation Builder will ask for downloading PLC configuration. Choose “Update”. Automation Builder will confirm that the program has changed.

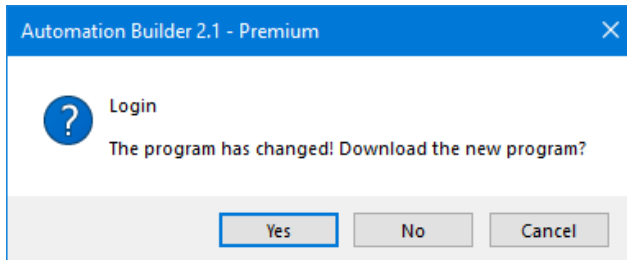
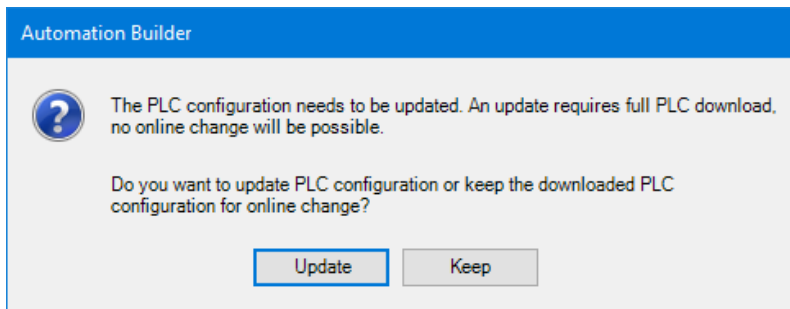

5.5. Build and run the PLC demo program

Use the key, F11, to build the program once. Login and start project from Automation Builder by clicking Alt+F8 to login the CodeSys. Click yes to login.

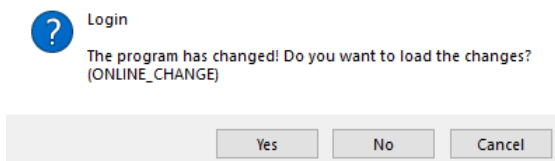

Click F5 to start. Switch to CoDeSys and click Alt+F8 to login demo. The program can be controlled with the view from CodeSys.

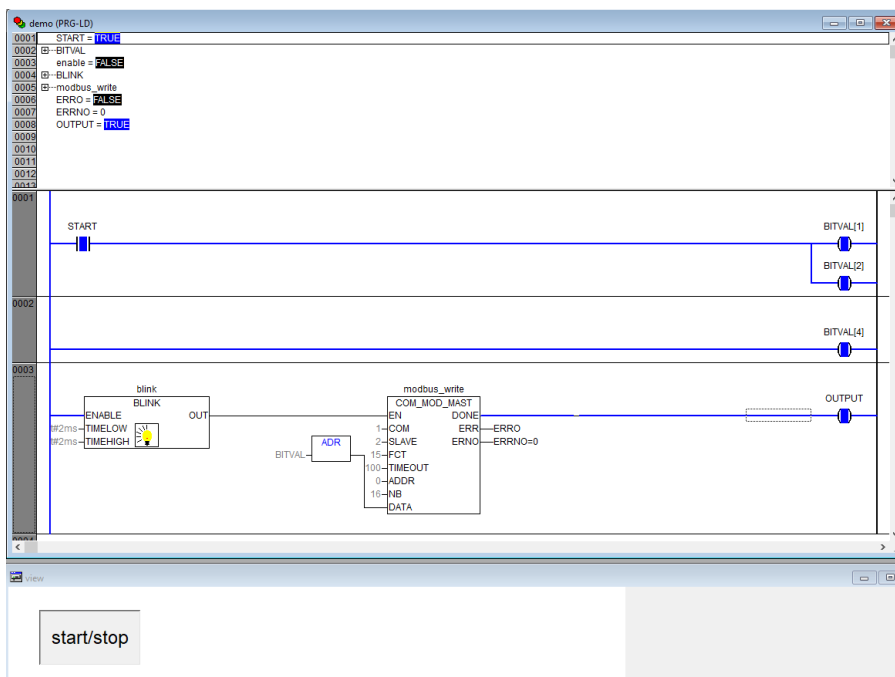

6. Contact us

For more information, please contact your local ABB representative or visit <https://solutions.abb/softstarters>

STATUS	SECURITY LEVEL	DOCUMENT ID.	REV.	LANG.	PAGE
Approved	Public	1SFC132086M0201	F	en	32/32