

—  
OPTIONS FOR ABB DRIVES

# FOCH filters

## Hardware manual





# FOCH filters

## Hardware manual

Table of contents



4. Installation





# Table of contents

---

## 1 Introduction to the manual

Contents of this chapter .....	7
Applicability .....	7
Target audience .....	7
Safety .....	7

## 2 Operation principle

Contents of this chapter .....	9
Operation principle .....	9
Graphs illustrating the effect of the $du/dt$ filter .....	9
Type designation label .....	10

## 3 Selecting the $du/dt$ filter

Contents of this chapter .....	13
Filter selection procedure .....	13
Applicability checks of the pre-selected filter .....	13
Maximum values table .....	14
Calculation example .....	14

## 4 Installation

Contents of this chapter .....	17
Planning the installation .....	17
Mounting plate .....	18
Encasing .....	18
Electrical connections .....	18
Free space .....	18
Non-enclosed (IP00) filters .....	19
Enclosed (IP22) filters .....	20
Clearance .....	20
Non-enclosed (IP00) filters .....	20
Enclosed (IP22) filters .....	20
Cooling .....	20
Tightening torques .....	21
Mechanical installation .....	21
Installing non-enclosed (IP00) filters .....	21
Installing enclosed (IP22) filters .....	21
Electrical installation .....	23
Connection diagram .....	23
Installation illustrations of an enclosed (IP22) filter .....	24
Grounding of the IP00-protected filter .....	25
Connections to input terminals U1, V1, W1 .....	25
Output terminals U2, V2, W2 .....	25
Strain relief of cables .....	25

---



6 Table of contents

**5 Technical data**

Ratings, weights and maximum cable sizes ..... 27  
Derating ..... 28  
Ambient conditions ..... 29  
Materials ..... 29  
Disposal ..... 29  
Markings ..... 30

**6 Dimension drawings**

FOCH0260-70 ..... 32  
FOCH0320-50, FOCH0610-70 and FOCH0875-70 ..... 33  
FOCH0260-72 ..... 34  
FOCH0320-52 ..... 35

**Further information**



# 1

## Introduction to the manual

---

### Contents of this chapter

This chapter describes the contents of the manual and gives some general information.

### Applicability

This manual applies to the following  $du/dt$  filter types:

- FOCH0260-70
- FOCH0260-72
- FOCH0320-50
- FOCH0320-52
- FOCH0610-70
- FOCH0875-70.

### Target audience

This manual is intended for people who select, plan the installation, install, commission and use the  $du/dt$  filter.

Read the manual before working on the filter. You are expected to know the fundamentals of electricity, wiring, electrical components and electrical schematic symbols.

### Safety

Only qualified specialists are allowed to install, commission and maintain the  $du/dt$  filter.

---

The complete safety instructions for the drive are given in the drive hardware manual. Read and follow the complete safety instructions before working on the drive.

The following instructions are intended for all who install and service the  $du/dt$  filter. Ignoring the following instructions can cause physical injury or death, or damage to the equipment.



**WARNING!**

- The filter is heavy. Lift the filter by the lifting holes only.
  - Non-enclosed (IP00) filter: Ground the filter to the protective earth (PE) terminal of the cabinet. No separate grounding conductor is needed if there is proper galvanic connection through the filter fixing screws, conductive metallic fixing base and the PE busbar of the cabinet.
  - Beware of hot surfaces. The surface temperature of the  $du/dt$  filter can be higher than 150 °C (302 °F) during operation. After the operation, let the filter cool off for two hours before working on it.  
Ensure sufficient cooling, see chapter Installation.
-





## Operation principle

---

### Contents of this chapter

This chapter describes the operation principle of the  $du/dt$  filter.

### Operation principle

The drive employs modern IGBT inverter technology. Regardless of frequency, the drive output comprises pulses of approximately the drive DC bus voltage with a very short rise time. The pulse voltage can almost double at the motor terminals, depending on the attenuation and reflection properties of the motor cable and the terminals. This can cause additional stress on the motor and motor cable insulation.

Modern variable speed drives with their fast rising voltage pulses and high switching frequencies can generate current pulses that flow through the motor bearings, which can gradually erode the bearing races and rolling elements.

There are optional common mode filters and  $du/dt$  filters available for the ABB drives. The common mode filters mainly reduce bearing currents. The  $du/dt$  filters also protect the motor insulation system.

To avoid damage to motor bearings and insulation system:

- Select and install the cables according to the instructions given in the drive hardware manual.
- Check if the installation needs to be equipped with additional protection equipment, such as insulated N-end bearings in the motor, or the drive output filters. The requirements are specified in the drive hardware manual. See chapter Planning the electrical installation.

#### ■ Graphs illustrating the effect of the $du/dt$ filter

The graphs show the peak line-to-line voltage ( $\hat{U}_{LL}$ ) and voltage change ( $du/dt$ ) at the motor terminals as a function of the motor cable length.  $\hat{U}_{LL}$  and  $du/dt$  are scaled to

---

## 10 Operation principle

the nominal line-to-line voltage ( $U_n$ ). To calculate the actual peak voltage value in volts and  $du/dt$  value in volts per microsecond, multiply the values of the graph by the supply voltage ( $U_n$ ).

The values in the first graph are measured with an ABB  $du/dt$  filter while the second graph without any output filtering. The values in the second graph are only representative. The actual unfiltered  $du/dt$  values depend on the drive type, and are usually in the range of 1 to 5 kV/microsecond.

The voltage rise time can be calculated as follows:  $t = 0.8 \cdot \hat{U}_{LL}/(du/dt)$ .

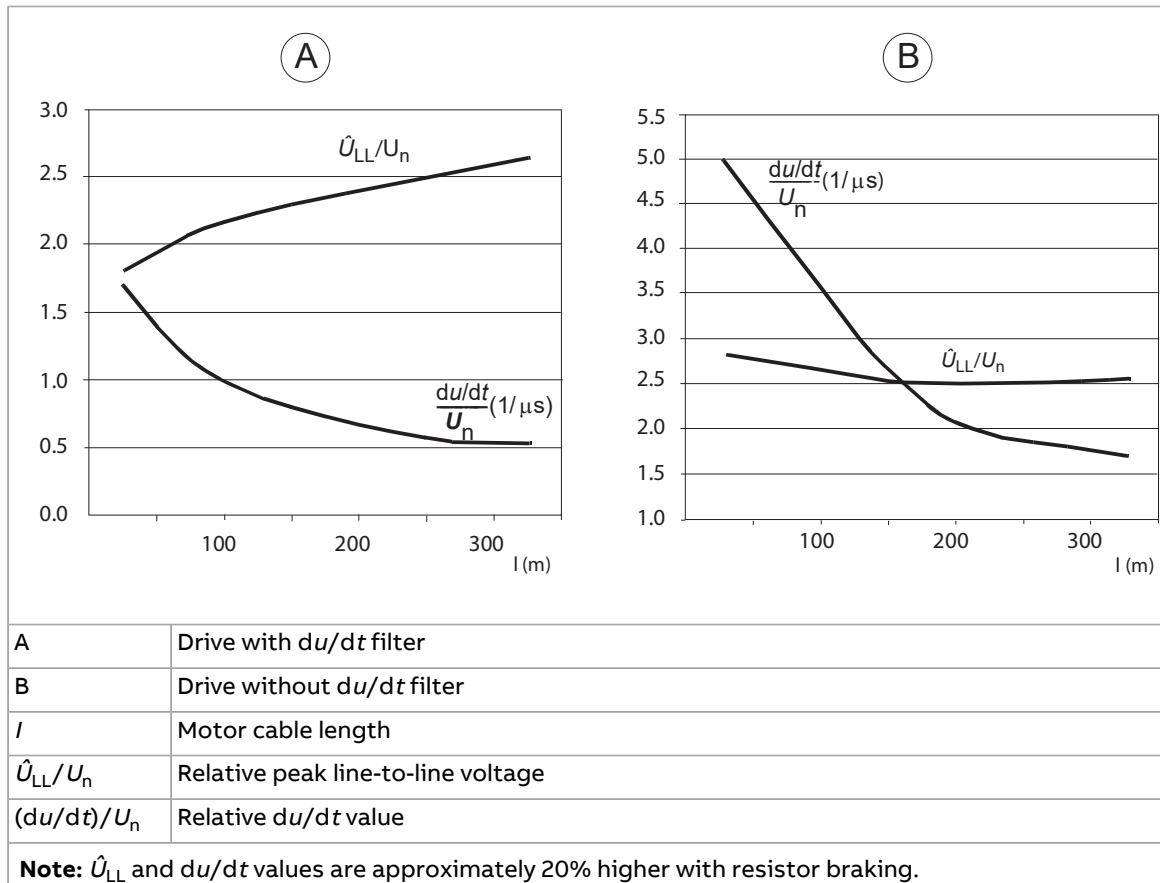

## Type designation label

The type designation label includes IEC and UL (NEC) ratings, appropriate markings and the type designation and serial number, which allow identification of each filter. An example label is shown below.

Origin Finland (2)  
 Made in Finland  
 ABB Oy (2)  
 Hiomotie 13  
 00380 Helsinki  
 Finland

U 3~ 380...690 V  
 I 65 A (525...690 V) (5)  
 I 89 A (380...500 V)  
 f 0...120Hz

(3)

Air cooled (4)  
 IP21 (UL type 1) S/N: xxxxxxxxxx (6)

(8) Type code: FOCHxxxx-xx  
 ABB code: 3AXDxxxxxxxxxx  
 Rev: A

CE (7)   
 UL LISTED (7) IND. CONT. EQ.

No.	Description
1	ABB logo
2	Country of origin and contact address
3	Link to the product data sheet
4	Degree of protection
5	Technical data
6	S/N: Serial number of format MYYWWXXXXX, where M: Manufacturing plant YY: 16, 17, 18, ... for 2016, 2017, 2018, ... WW: 01, 02, 03, ... for week 1, week 2, week 3, ... XXXXX: Digits making the serial number unique
7	Valid markings
8	Type code, ABB material code, revision letter





## Selecting the $du/dt$ filter

---

### Contents of this chapter

The chapter instructs in selecting a  $du/dt$  filter for your drive.

### Filter selection procedure

Step	What to do	More information
1	Check whether a $du/dt$ filter is needed in the installation.	The requirements are specified in the drive hardware manual. See chapter Planning the electrical installation. <sup>1)</sup>
2	Pre-select a filter according to the drive type.	Filter selection tables are in the drive hardware manual. <sup>1)</sup>
3	Check that the pre-selected filter is suitable for your application.	See section Applicability checks of the pre-selected filter. If the checks are passed, use the pre-selected filter. If any of the conditions is not met, choose a bigger filter, use two filters in series or change the motor cabling. <sup>2)</sup>

<sup>1)</sup> For the ACS880 drives, the data can be found either from the appropriate Technical catalog or Hardware manual. The PDF files are available at [www.abb.com/drives](http://www.abb.com/drives).

<sup>2)</sup> FOCH0260-7x cannot be replaced with a bigger filter due to the higher inductance in the FOCH0260-7x.

### Applicability checks of the pre-selected filter

Long or several parallel motor cables, or special cable types may cause additional temperature rise in the filter. Therefore, check that the filter selected on the basis of the filter selection table fulfils the application requirements:

- The motor cable is not longer than the maximum allowed motor cable length given in the drive hardware manual.
  - The energy loss in the  $du/dt$  filter is not higher than the maximum allowed value ( $E_{max}$ ) given in subsection [Maximum values table \(page 14\)](#) below. The energy loss is calculated as follows:
-

## 14 Selecting the du/dt filter

$$E = \frac{1}{2} \cdot C \cdot (U_{dc})^2$$

where

- E = energy loss in the du/dt filter
- C = total capacitance of the motor cable(s), ie, the product of the capacitance/length value given in the cable catalogue and the length of the motor cable. In case of several motor cables, the total capacitance is the sum of the individual cable capacitances.
- $U_{dc}$  = average intermediate circuit DC voltage of the drive = approximately  $1.35 \cdot U_N$
- $U_N$  = drive supply voltage.

- The current flow through the filter is not higher than the maximum allowed value given in subsection maximum values table below.

### ■ Maximum values table

This table gives maximum allowed rms current ( $I_{thmax}$ ) and energy dissipation ( $E_{max}$ ) values for the du/dt filters. The filter will not overheat when these values are not exceeded (and proper cooling is arranged).

du/dt filter type	$I_{thmax}^{1)}$ (A)	$E_{max}$ (mJ)
FOCH0260-70	289	200
	230	280
FOCH0260-72	289	100
	230	140
FOCH0320-50	445	260
	361	340
FOCH0320-52	445	130
	361	170
FOCH0610-70	720	120
	560	180
	445	260
FOCH0875-70	880	85
	820	95
	725	115

<sup>1)</sup> In temperatures above +40 °C (+104 °F) and/or altitudes above 1000 m (3281 ft), derate the  $I_{thmax}$  values as instructed on page 28.

### ■ Calculation example

An FOCH0610-70 du/dt filter has been selected for a drive which supplies three motors with the following cables in parallel:

- 100 m MCMK 3×50+16, C = 0.6 microF/km,  $I_{th1}$  = 105 A.
- 250 m MCMK 3×70+35, C = 0.65 microF/km,  $I_{th2}$  = 148 A.
- 300 m MCMK 3×120+70, C = 0.8 microF/km,  $I_{th3}$  = 210 A.

The total capacitance of the motor cables is

$$C = 0.1 \times 0.6 \text{ microF} + 0.25 \times 0.65 \text{ microF} + 0.3 \times 0.8 \text{ microF} = 463 \text{ nF.}$$

The total continuous rms current of the motors is

$$I_{th} = I_{th1} + I_{th2} + I_{th3} = 463 \text{ A.}$$

The supply voltage ( $U_N$ ) is 660 V. Thus, the average intermediate circuit DC voltage of the drive is

$$U_{dc} = 1.35 \times U_N = 1.35 \times 660 \text{ V} = 891 \text{ V.}$$

The additional energy loss in the  $du/dt$  filter is

$$E = \frac{1}{2} \cdot C \cdot (U_{dc})^2 = \frac{1}{2} \times 463 \text{ nF} \times (891 \text{ V})^2 = 184 \text{ mJ.}$$

When 463 A and 184 mJ are compared to the values of Maximum values table, it can be seen that a filter of type FOCH0610-70 can be used.

---





# 4

## Installation

---

### Contents of this chapter

This chapter contains mechanical and electrical installation instructions.

### Planning the installation

See chapter [Technical data \(page 27\)](#) for allowed ambient conditions, maximum cable length between the drive output and the filter, maximum motor cable length and other technical data.

See chapter [Dimension drawings \(page 31\)](#) for the dimensions. Non-enclosed (IP00) filters can be mounted in an upright position with the output terminals up or down. Other mounting positions are possible with an extra fan. Enclosed (IP22) filters must be installed in the upright position with the air outlet gratings on the upper part of the side plates (and guiding the air downwards).

The figure below shows the mounting position alternatives of a non-enclosed (IP00) filter.

---



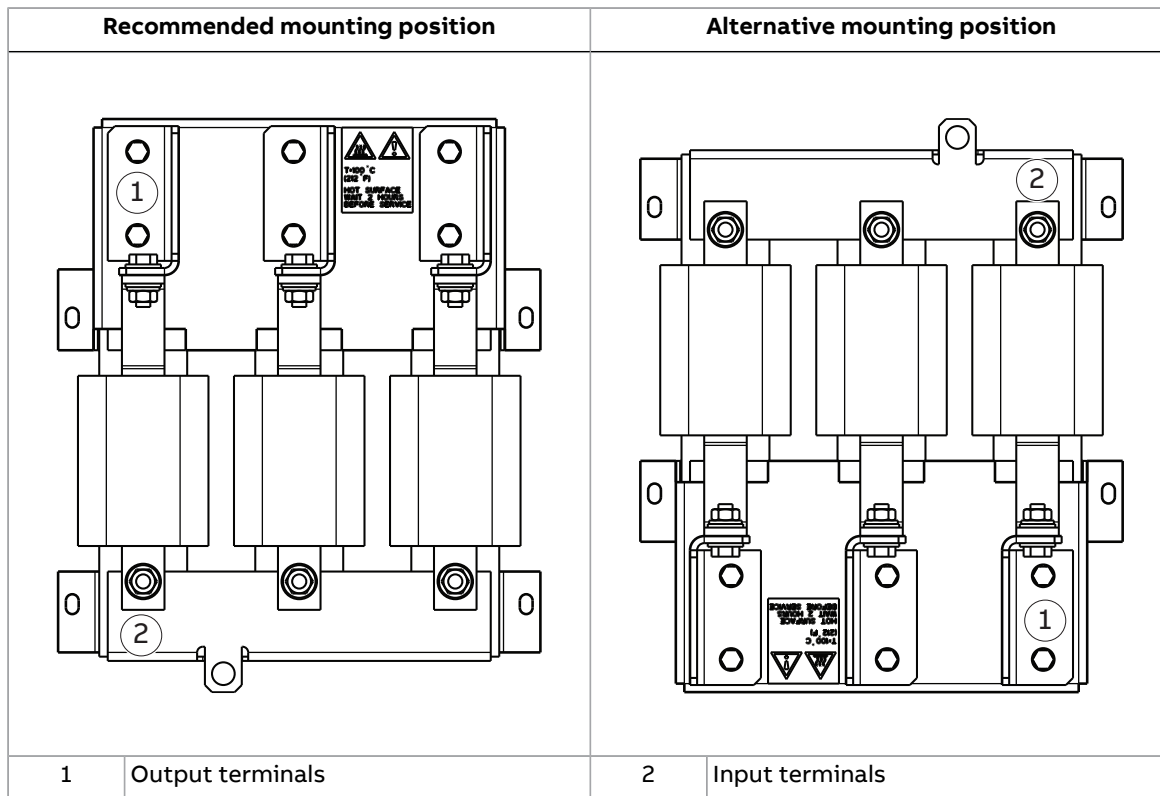

### ■ Mounting plate

Non-enclosed (IP00) filters must be mounted on a grounded metal plate or cabinet frame. Enclosed (IP22) filters can be installed to a wall without any grounded metal plate. The structure must be of non-flammable material and strong enough to carry the weight of the unit.

### ■ Encasing

Non-enclosed (IP00) filters must be encased or placed in a cabinet according to the local safety requirements.

### ■ Electrical connections

- Busbars are recommended for connections to the input terminals of non-enclosed (IP00) filters.
- Cables are recommended for connections to the input terminals of enclosed (IP22) filters.

Cables must be protected for at least 105 °C (221 °F). If the filter is not installed in the same cabinet as the drive, shielded symmetrical cable must be used between the drive cabinet and the filter enclosure.

### ■ Free space

Free space is required around the filter for cooling as follows. The distances apply to natural convection. With forced cooling, less free space is required.

**Non-enclosed (IP00) filters**

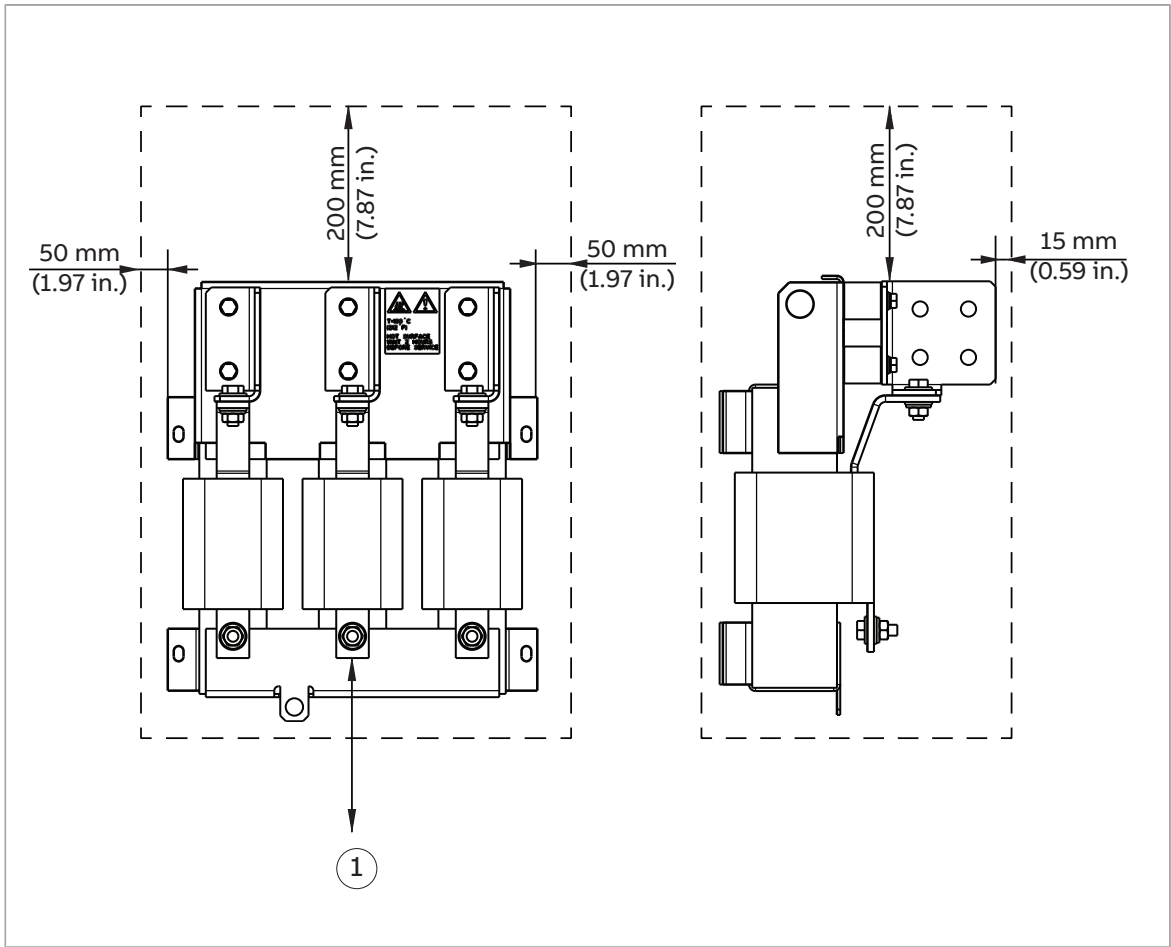

1	Space required by the cabling or busbars
---	--

**Note:** The temperature of the filter surfaces can exceed 150 °C [302 °F] during operation. Ensure that the motor cables are at least 50 mm (1.97 in.) away from the coil surfaces.



## Enclosed (IP22) filters

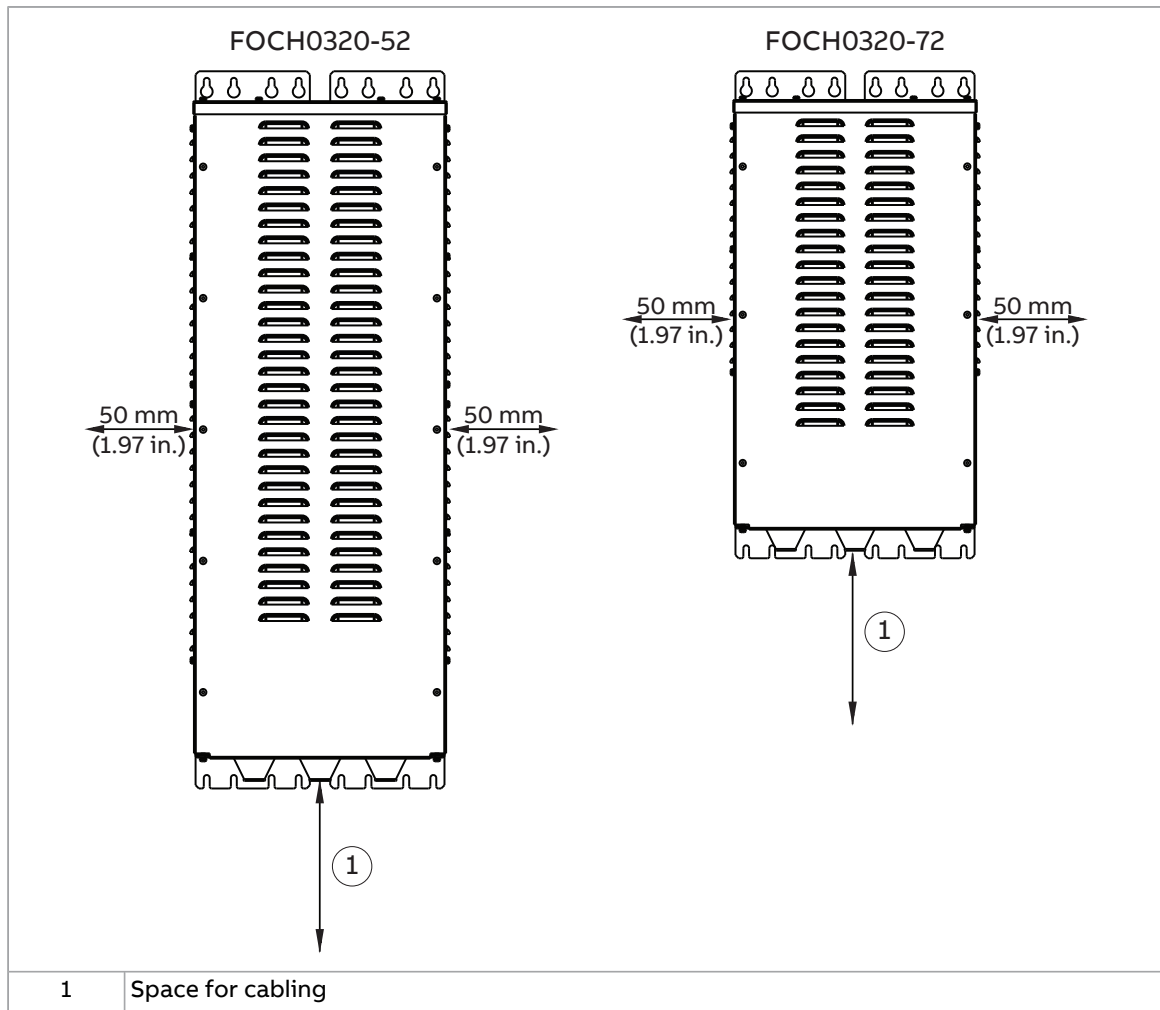

### ■ Clearance

#### Non-enclosed (IP00) filters

- The distance between the enclosure and the filter coil must be at least 15 mm (0.59 in.).
- The distance between the enclosure and the input/output terminals must be at least 15 mm (0.59 in.).
- The distance between the input busbars (if in use instead of cabling) and the filter coil must be at least 15 mm (0.59 in.).

#### Enclosed (IP22) filters

The distance between the input/output cabling and the filter coil must be at least 50 mm (1.97 in.).

### ■ Cooling

The filters are designed to cool by natural convection. Ensure that there is enough fresh cooling air available and that the hot air can freely escape from the filter enclosure or cubicle. The air space above the non-enclosed (IP00) filter and the outlet air of the enclosed (IP22) filter is hot [up to 70 °C (158 °F) depending on the installation and operating conditions]. Take this into account in the installation.

## Tightening torques

The following table applies to grade 8.8 screws with or without joint compound.

Screw size	Torque	
	N·m	lbf·ft
M4	3	2
M5	3.5	2.6
M6	9	6.6
M8	20	14.8
M10	40	29.5
M12	70	51.6
M16	180	132.8

## Mechanical installation



### WARNING!

Do not attempt any work on a powered drive. After switching off and disconnecting the power supply, always allow the intermediate circuit capacitors 5 minutes to discharge before working on the frequency converter, the motor or the motor cable. Check (with a voltage indicating instrument) that the drive is in fact discharged before beginning work.



### ■ Installing non-enclosed (IP00) filters

Lift the filter by the lifting holes to the installation position. Fasten the filter with four screws at the fastening points in the mounting legs or with FOCH0320-50 and FOCH0610-70 alternatively with two screws in the upper mounting leg and four screws in the base plate of the filter core.

### ■ Installing enclosed (IP22) filters

1. Measure the fastening hole locations and make the holes to the wall.
2. Insert the fixing anchors to the holes and start fastening screws in the anchors. Use a sufficient number of screws and drive them long enough into the wall to make them carry the weight of the filter.
3. Put the filter on the screw.
4. Tighten the screws.

FOCH0320-52

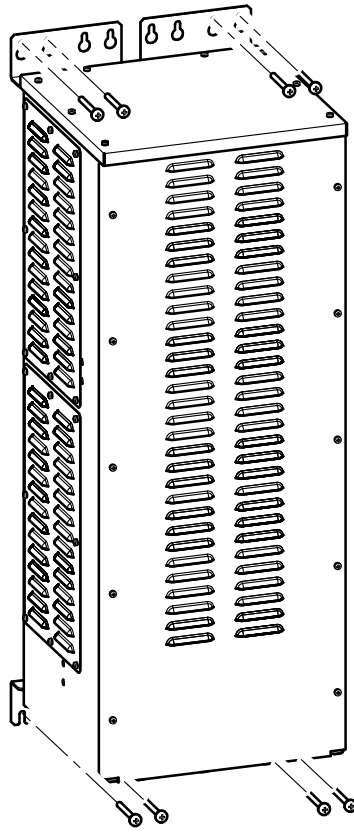

# Electrical installation

## ■ Connection diagram

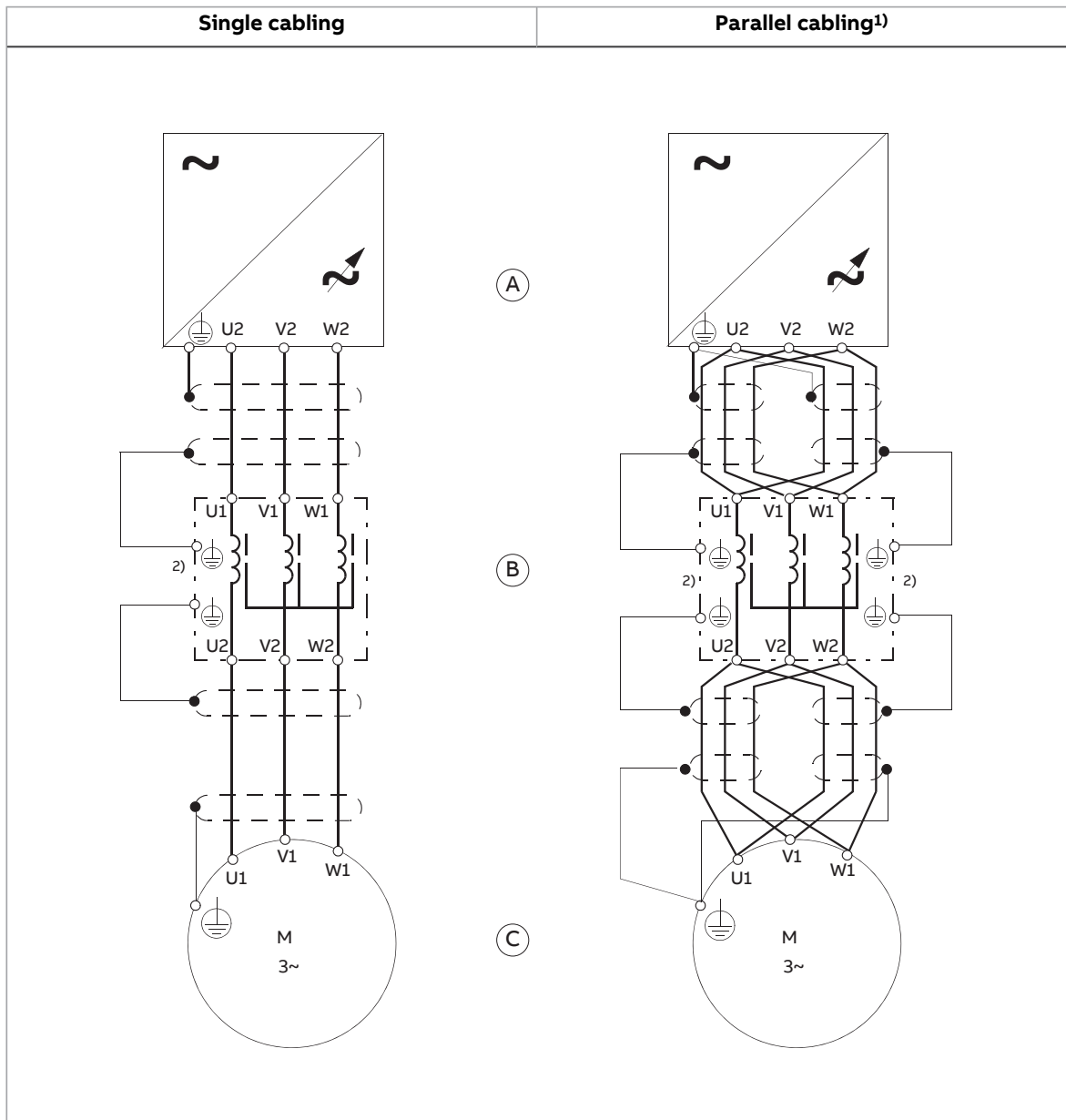

1	You can use a maximum of three parallel cables.
2	The diagram shows the grounding connections of an enclosed filter: It includes the grounding clamps for the cable shields (PE conductors). If you have an enclosed (IP22) filter, you do the connection as shown above. If you have a non-enclosed (IP00) filter, you must connect the cable shields to the PE busbar of the cabinet in which you have installed the filter. You must also make sure that the filter frame has a proper connection to the cabinet PE busbar through the mounting screws and cabinet metal structures. If in doubt, use a separate grounding wire.
A	Drive
B	FOCH du/dt filter
C	Motor



■ Installation illustrations of an enclosed (IP22) filter

FOCH0320-52

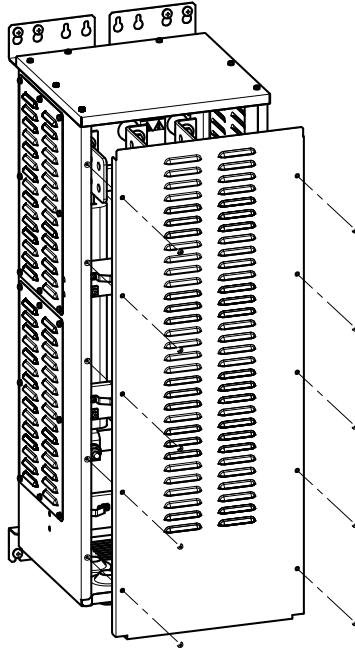

FOCH0320-52

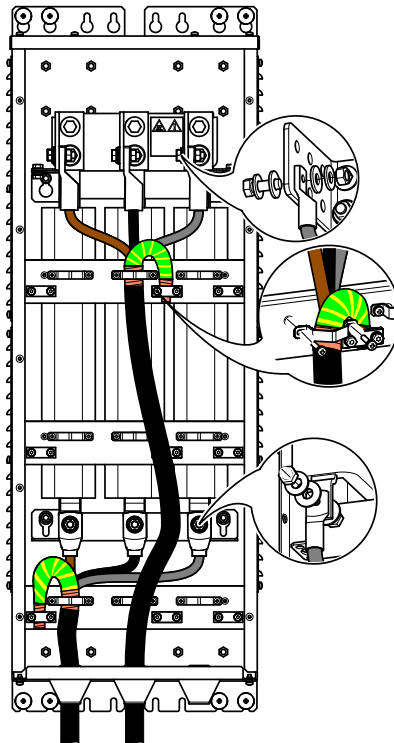



## ■ Grounding of the IP00-protected filter

---



### **WARNING!**

The filter is grounded through the four fastening screws to its mounting plate. Ensure that the mounting plate has a proper connection to the nearest grounding (PE) busbar/terminal. If that is not the case, use a separate grounding conductor between the filter frame and the PE busbar/terminal.

---

## ■ Connections to input terminals U1, V1, W1

The input terminals (U1, V1, W1) of the filter are made of aluminium. Use cable lugs suitable for aluminium busbars and joint grease to avoid corrosion and to ensure good electrical connection. The oxide layer must be scrubbed off from the joints before applying the grease. ABB recommends to

- use screws included in the delivery
- retighten the connections 30 minutes after their installation.

## ■ Output terminals U2, V2, W2

The output terminals (U2, V2, W2) of the filter are tin-plated copper.

## ■ Strain relief of cables

Secure the cables mechanically.





# 5

## Technical data

This chapter contains the technical specifications of the  $du/dt$  filter and its installation.  
 Input voltage (U1): 380 ... 500 V AC 3-phase  $\pm 10\%$ , 380 ... 690 V AC 3-phase  $\pm 10\%$ .

### Ratings, weights and maximum cable sizes

Filter type	FOCH0260-70	FOCH0320-50	FOCH0610-70	FOCH0875-70	FOCH0260-72	FOCH0320-52
Order code	68490286	68612217	68550483	3AUA0000125245	3AXD50000030048	3AXD50000030047
$U_N$ (V)	690	500	690	690	690	500
$I_N$ (A)	289	445	720	880	289	445
L (microH)	35	22	22	15	35	22
Power loss (W)	370	520	760	630	370	520
Weight (kg (lb))	47 (104)	65 (143)	65 (143)	65 (143)	74 (163)	102 (225)
Maximum motor cable size in mm <sup>2</sup>	3×(3×240)	3×(3×240)	3×(3×240)	3×(3×240)	3×(3×240)	3×(3×240)
Output connection size	M12	M12	M12	M12	M12	M12
Input connection size	M10	M12	M12	M12	M10	M12
Degree of protection	IP00	IP00	IP00	IP00	IP22	IP22

## Derating

The load capacity (current and power) decreases if the installation site altitude exceeds 1000 metres (3281 ft), or if the ambient temperature exceeds 40 °C (104 °F).

### Temperature derating:

In the temperature range +40 °C (+104 °F) to +50 °C (+122 °F), the rated output current is decreased 1% for every additional 1 °C (1.8 °F). The output current is calculated by multiplying the current given in the rating table by the derating factor.

### Example:

If the ambient temperature is 50 °C (+122 °F), the derating factor is 100% - (1 % / 1 °C) · 10 °C = 90% or 0.90. The output current is then  $0.90 \cdot I_{thmax}$ . For  $I_{thmax}$ , see maximum values table on page 12.

### Altitude derating:

At altitudes from 1000 to 4000 m (3281 to 13123 ft) above sea level, the derating is 1% for every 100 m (328 ft). For a more accurate derating, use the DriveSize PC tool. The value calculated for the drive applies also to its  $du/dt$  filter.

**Maximum drive output frequency:** 120 Hz

### Maximum allowed average switching frequency:

3 kHz (converter units with supply voltage < 500 V and 500 V) or 2 kHz (converter units with supply voltage > 500 V)

Change the switching frequency with a drive parameter. If there is no such parameter in the drive software, apply the settings to be used with long motor cables. For example, for the ACS880 drive, bit 13 of parameter 95.20 HW options word 1 must be switched on. The setting enables an overtemperature protection for the filter. For further information, see the appropriate firmware and hardware manuals.

**Maximum cable length between the drive output and the filter:** 3 m

**Applicable standards and markings:** EN 60204-1, EN 60529, EN 61800-5-1, EN 50178, UL listed in UL E211945, CSA certified in Certificate 206573, CE marking, UL approved insulation system.

---

## Ambient conditions

	Operation installed for stationary use	Storage in the protective package	Transportation in the protective package
Installation site altitude	0 to 4000 m (13123 ft) above sea level [above 1000 m (3281 ft), see De- rating on page 21.]	-	-
Air temperature	-15 to +50 °C (5 to 122 °F). See Derating on page 21.	-40 to +70 °C (-40 to +158 °F)	-40 to +70 °C (-40 to +158 °F)
Relative humidity	5 to 95%	Max. 95%	Max. 95%
	No condensation allowed. Maximum allowed relative humidity is 60% in the presence of corrosive gases.		
Contamination levels (IEC 60721-3-3, IEC 60721- 3-2, IEC 60721-3-1)	No conductive dust allowed.		
	Chemical gases: Class 3C2 Solid particles: Class 3S2	Chemical gases: Class 1C2 Solid particles: Class 1S3	Chemical gases: Class 2C2 Solid particles: Class 2S2
Atmospheric pressure	70 to 106 kPa 0.7 to 1.05 atmospheres	70 to 106 kPa 0.7 to 1.05 atmospheres	60 to 106 kPa 0.6 to 1.05 atmospheres
Vibration (IEC 60068-2)	Max. 1 mm (0.04 in.) (5 to 13.2 Hz), max. 7 m/s <sup>2</sup> (23 ft/s <sup>2</sup> ) (13.2 to 100 Hz) sinusoid- al	Max. 1 mm (0.04 in.) (5 to 13.2 Hz), max. 7 m/s <sup>2</sup> (23 ft/s <sup>2</sup> ) (13.2 to 100 Hz) sinusoidal	Max. 3.5 mm (0.14 in.) (2 to 9 Hz), max. 15 m/s <sup>2</sup> (49 ft/s <sup>2</sup> ) (9 to 200 Hz) sinusoidal
Shock (IEC 60068-2-29)	Not allowed	Max. 100 m/s <sup>2</sup> (330 ft./s <sup>2</sup> ), 11 ms	Max. 100 m/s <sup>2</sup> (330 ft./s <sup>2</sup> ), 11 ms
Free fall	Not allowed	203 mm (7.99 in.)	203 mm (7.99 in.)

## Materials

<b>Input terminals (U1, V1, W1)</b>	Aluminium
<b>Output terminals (U2, V2, W2)</b>	Tin-plated copper

## Disposal

The main parts of the drive can be recycled to preserve natural resources and energy. Product parts and materials should be dismantled and separated.

Generally all metals, such as steel, aluminum, copper and its alloys, and precious metals can be recycled as material. Plastics, rubber, cardboard and other packaging material can be used in energy recovery.

Printed circuit boards and DC capacitors need selective treatment according to IEC 62635 guidelines.

To aid recycling, most plastic parts are marked with an appropriate identification code. In addition, components containing substances of very high concern (SVHCs) are listed in European Chemicals Agency's SCIP database. SCIP is the database for information on Substances of Concern In articles as such or in complex objects (Products) established under the Waste Framework Directive (2008/98/EC). For further





information, contact your local ABB distributor or consult European Chemicals Agency's SCIP database to find out which SVHCs are used in the drive, and to find out where those components are located.

Contact your local ABB distributor for further information on environmental aspects. End of life treatment must follow international and national regulations.

For more information on ABB end of life services, refer to [new.abb.com/service/end-of-life-services](http://new.abb.com/service/end-of-life-services).

## Markings

These markings are attached to the drive:

	<p>CE mark Product complies with the applicable European Union legislation. For fulfilling the EMC requirements, see the additional information concerning the drive EMC compliance (IEC/EN 61800-3).</p>
	<p>UL Listed mark for USA and Canada Product has been tested and evaluated against the relevant North American standards by the Underwriters Laboratories. Valid with rated voltages up to 600 V.</p>
	<p>Electronic Information Products (EIP) symbol including an Environment Friendly Use Period (EFUP). Product is compliant with the People's Republic of China Electronic Industry Standard (SJ/T 11364-2014) about hazardous substances. The EFUP is 20 years. China RoHS II Declaration of Conformity is available from <a href="https://library.abb.com">https://library.abb.com</a>.</p>
	<p>WEEE mark At the end of life the product should enter the recycling system at an appropriate collection point and not placed in the normal waste stream.</p>



## Dimension drawings

---

The dimensions are given in millimetres and [inches] below.

---

FOCH0260-70

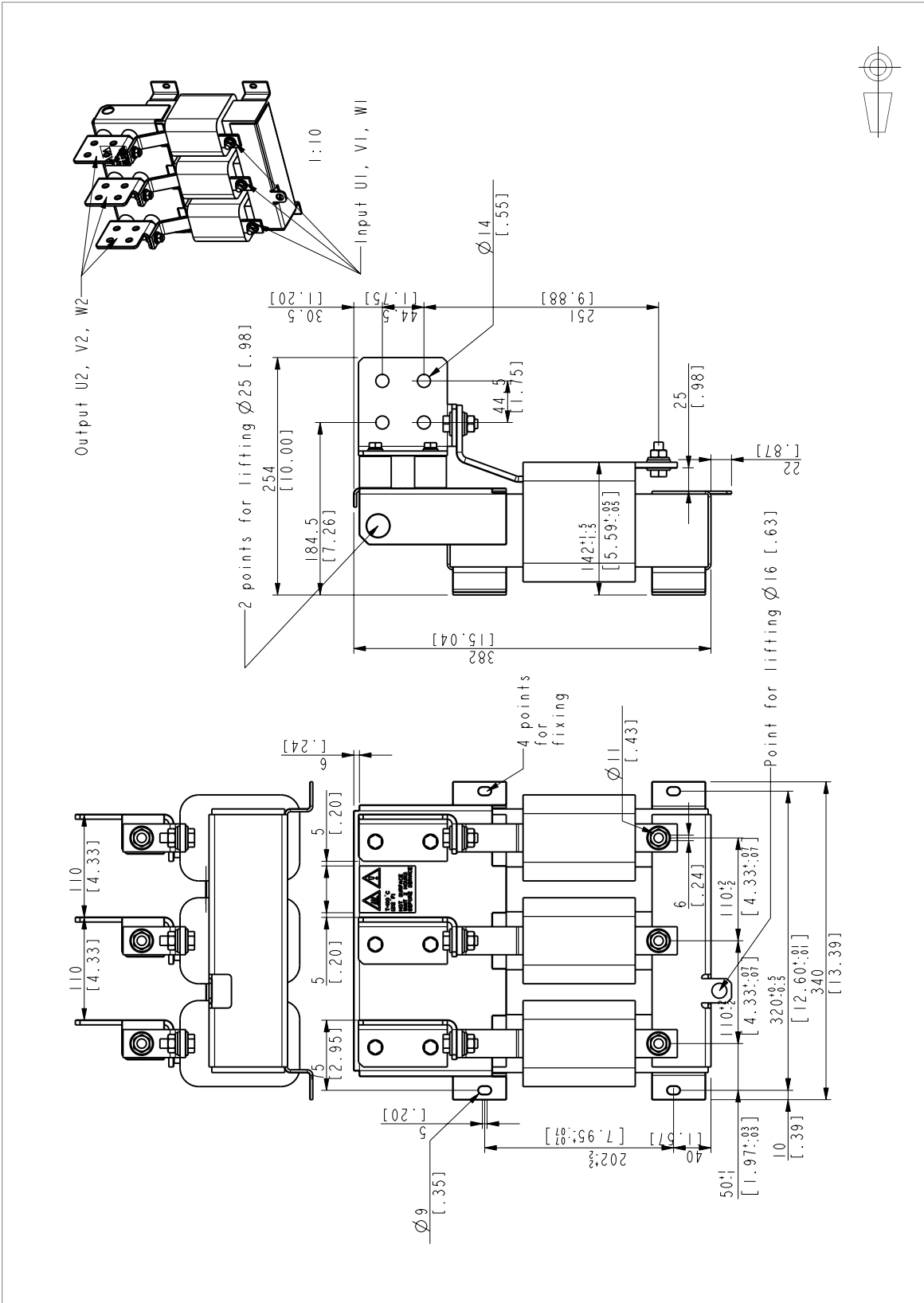



# FOCH0320-50, FOCH0610-70 and FOCH0875-70

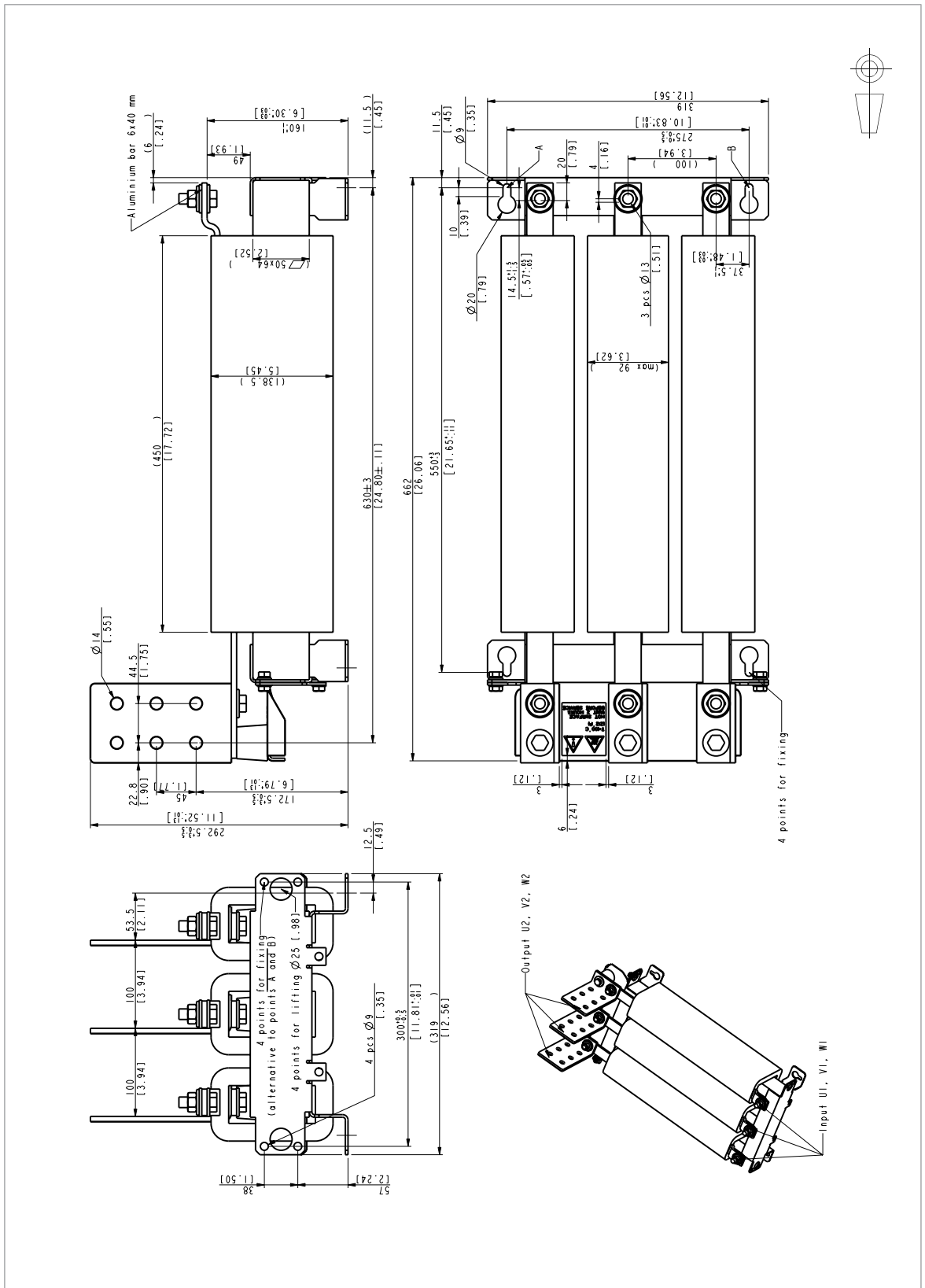

# FOCH0260-72

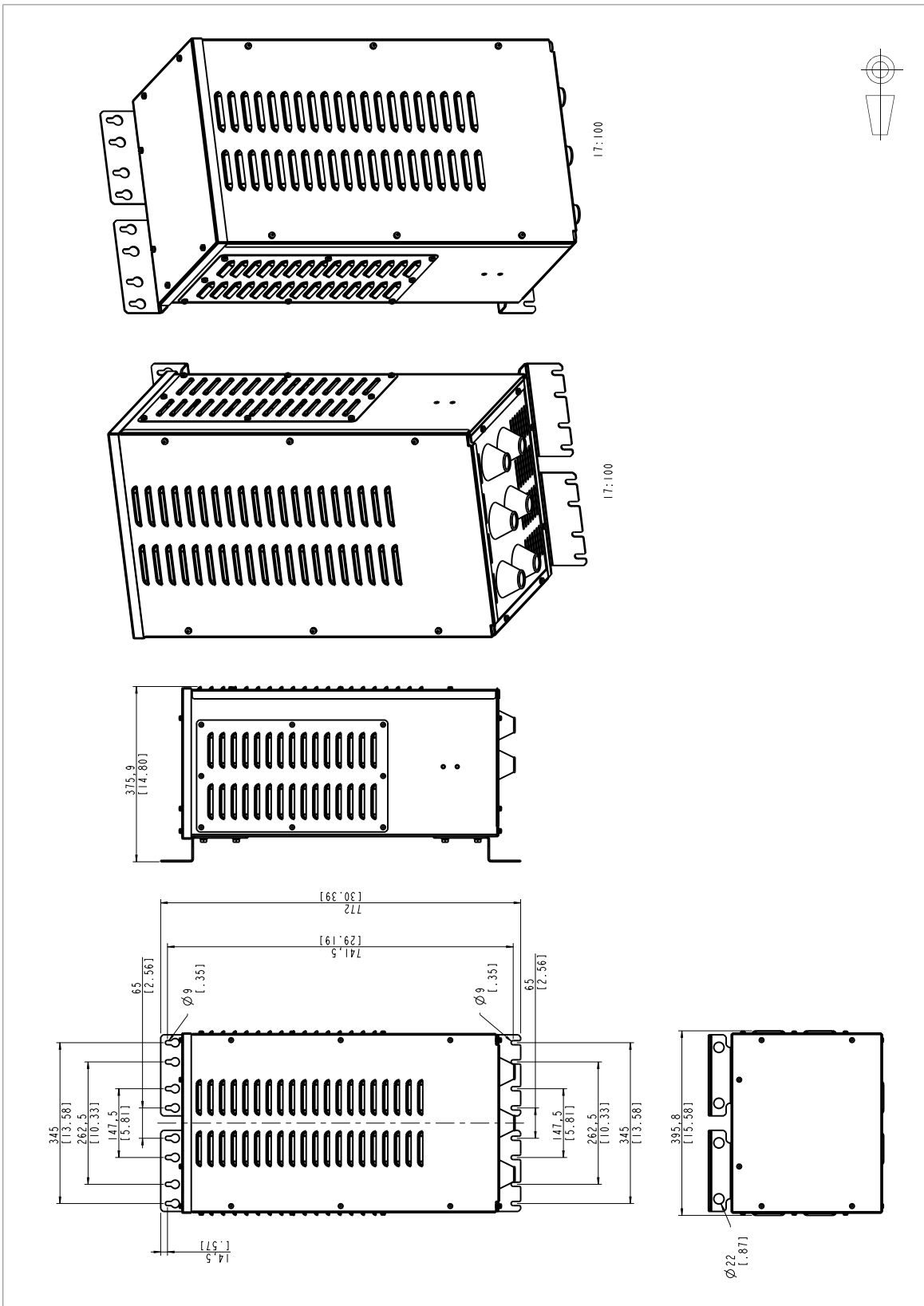

# FOCH0320-52

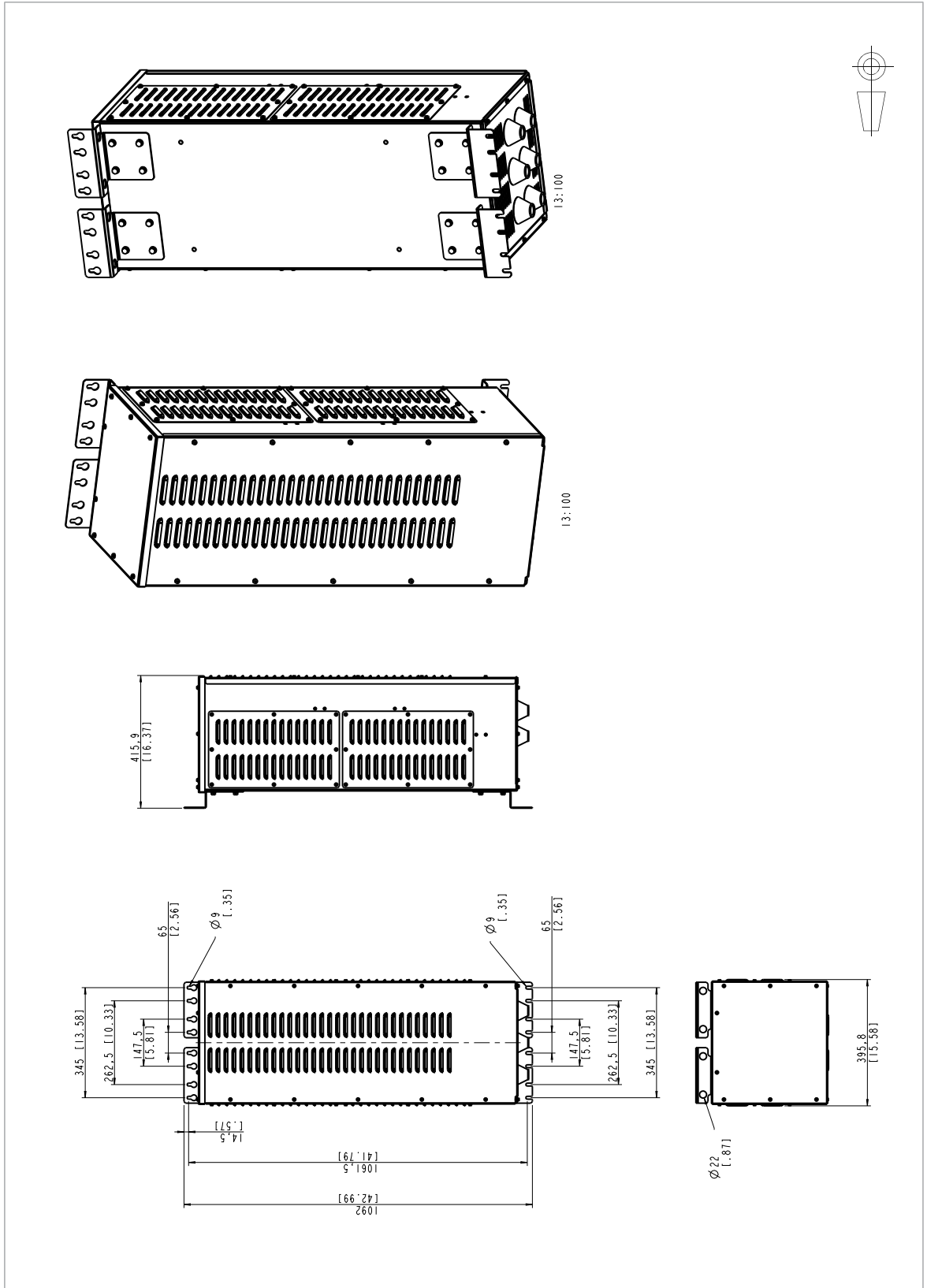



---

# Further information

## Product and service inquiries

Address any inquiries about the product to your local ABB representative, quoting the type designation and serial number of the unit in question. A listing of ABB sales, support and service contacts can be found by navigating to [www.abb.com/contact-centers](http://www.abb.com/contact-centers).

## Product training

For information on ABB product training, navigate to [new.abb.com/service/training](http://new.abb.com/service/training).

## Providing feedback on ABB manuals

Your comments on our manuals are welcome. Navigate to [new.abb.com/drives/manuals-feedback-form](http://new.abb.com/drives/manuals-feedback-form).

## Document library on the Internet

You can find manuals and other product documents in PDF format on the Internet at [www.abb.com/drives/documents](http://www.abb.com/drives/documents).



[www.abb.com/drives](http://www.abb.com/drives)



3AFE68577519G