

Electrical installation solutions for buildings

SMISSLINE TP plug-in system

Index

MCB S 400 E	9/6
MCBs S 400 M	9/10
MCBs S 400 M-UC	9/20
MCBs S400 P	9/22
MCBs SUP401 M-K	9/29
RCCBs F400	9/31
RCBOs FS401	9/38
RCBOs FS401 type F	9/41
RCBOs FS403	9/42
RCBO FS402	9/46
Surge arrester	9/48
Switch disconnecter	9/51
Auxiliary elements and accessories	9/52
Busbar system 125A	9/56
Combi modules adapter for manual motor starter and DIN adapters	9/73
Busbar system 250A	9/80
Busbar system direct feed	9/90

SMISSLINE TP plug-in system

Introduction	9/93
--------------	------

SMISSLINE TP interior expansion with CombiLine

Options for assembly in an enclosure	9/96
For horizontal and vertical device arrangement	9/97

Plug-in system

Cable laying grids, DIN rails, fixing brackets	9/99
Cover holders, panel connectors, raising frames	9/100
Plastic cover horizontal	9/101
Plastic cover vertical	9/102

Planning aid

Socket calculation with e-Design and Panel Design Configurator	9/103
Comparison of starting package with plug-in socket in individual parts	9/104
Assignment of CombiLine modules	9/105

SMISLINE TP plug-in system

Changes are never been easier

SMISLINE TP ensures that load-free devices and components can be snapped on and off under voltage without the need for additional personal protective equipment to guard against electrical hazards.

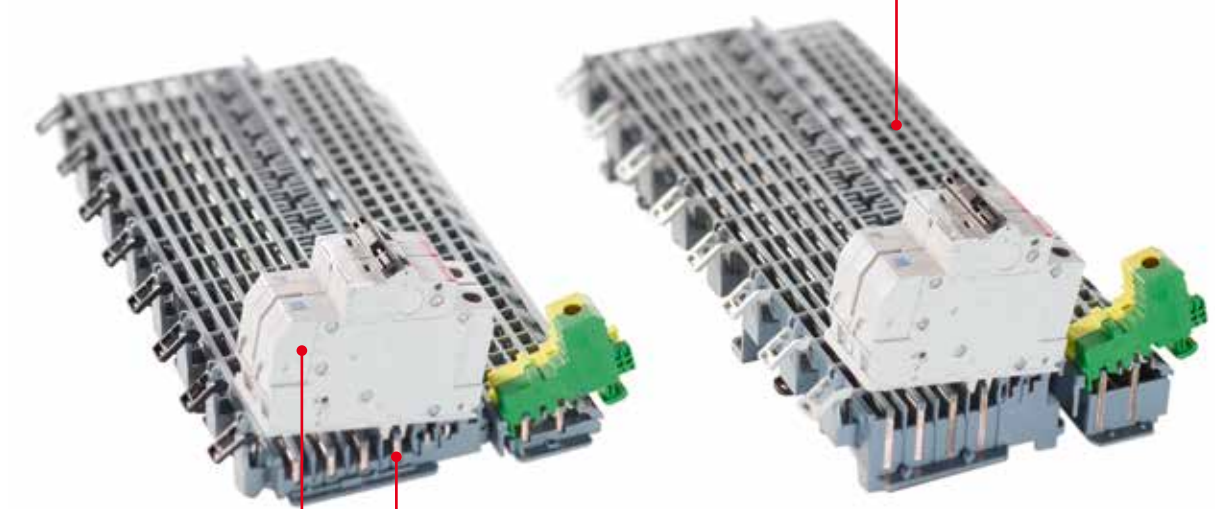

It opens up to a completely new prospects for you when it comes to installation, operation and flexibility.

The world's first pluggable socket system. 125A system and the new 250A Power Bar system.

SMISLINE TP plug-in system

Changes are never been easier

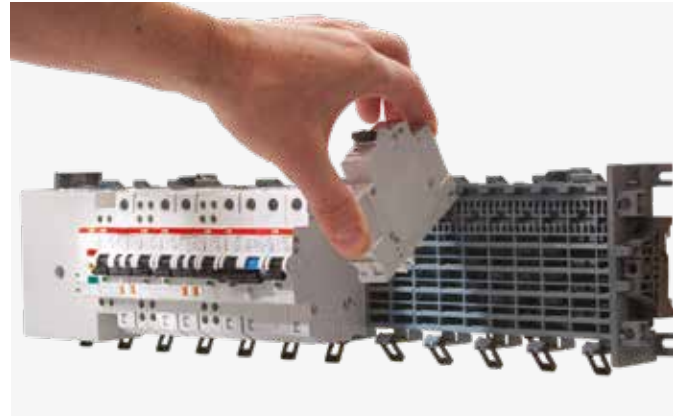

Even safer: Protection against electrical hazards

We have upgraded our unique SMISLINE socket system even further through the addition of a pioneering innovation. With the new SMISLINE TP system, components can now be plugged in or unplugged load-free without any risk from electrical current running through the body.

The SMISLINE TP pluggable socket system is completely finger-safe (IP2XB) – when devices are plugged in and unplugged, the system is always touch-proof. This means that SMISLINE TP prevents any danger to personnel from switching arcs or accidental arcing.

Even more flexible: make additions and changes during on-going operation

Pluggable devices can be added and changed quickly, safely and simply during ongoing operation. And this can be done without any need for personal protective equipment.

This means that you benefit from more flexibility, savings on installation and maintenance – and improved safety. SMISLINE TP provides greater availability and operating safety than conventional systems.

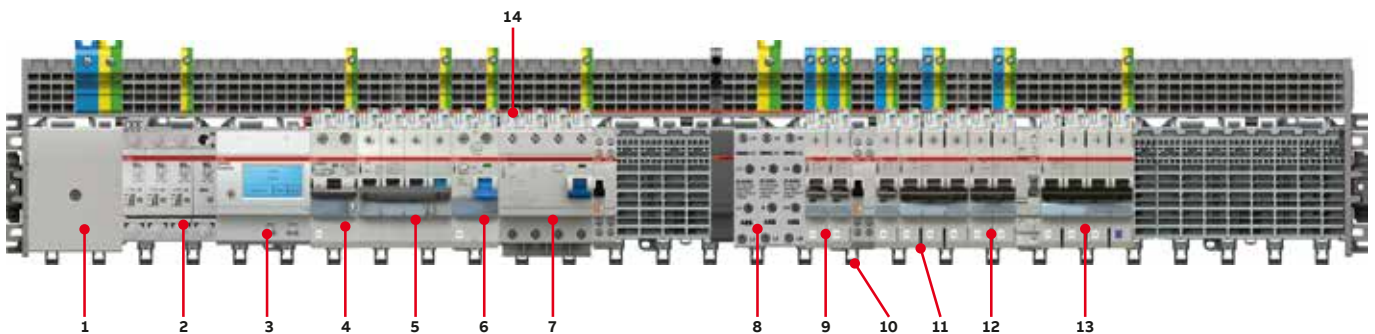

- | | | |
|--|--|---|
| 1 Incoming block 125/160A | 6 2-pole residual current operated circuit breaker | 12 Miniature circuit breaker 2 poles |
| 2 Surge arrester | 7 4-pole residual current operated circuit breaker | 13 4-pole residual current operated circuit breaker with overcurrent protection |
| 3 Control unit for Current measurement system | 8 Incoming block 63A | 14 Current measurement sensor |
| 4 2-pole residual current operated circuit breaker with overcurrent protection | 9 Miniature circuit breaker 1 pole | |
| 5 4-pole residual current operated circuit breaker with overcurrent protection | 10 Device latch | |
| | 11 Miniature circuit breaker 3 poles | |

Power behind bars

The world's safest socket system

Small cause, large effect: as the world's first pluggable socket system, SMISLINE TP ensures that load-free devices and components can be snapped on and off under voltage without the need for additional personal protective equipment to guard against electrical hazards. That opens up completely new prospects for you when it comes to installation, operation and flexibility.

New Power Bar System 250 A

The new 250 A system is now available in the shape of the SMISLINE TP. The busbars have a rated amperage of 250 A and therefore allow an end feed of 250 A. This extends the spectrum of potential applications.



Miniature circuit breaker (MCB)

Electrical installation solutions for buildings

New, patented bidirectional terminal with captive screws for maximum comfort, safety and flexibility. The connection takes place in two chambers (35 mm² and 6 mm²). Two conductors with the same cross-section can be connected in each chamber

Reliable recognition of the switching status through the new red/green position indicating device that shows the position of the inner contacts

Laser printing for scratch- and solvent-resistant identification marking



Tripping characteristics B, C. Rated breaking capacity of 6 kA to IEC/EN 60898-1

Pole conductor indicator changes when the contact is moved to the rear of the device

Miniature circuit breaker (MCB) for IEC

S400E technical features



When installed correctly the requirements of EN/IEC 61439-2 are met.

S400E	
General data	
Tripping characteristics	B,C
Poles	1P, 1P+NP, 2P, 3P, 3P+NP
Rated current I_n	6 A ... 63 A
Rated frequency f	50/60 Hz
Rated insulation voltage U_i acc. to DIN EN 60664-1	440 VAC
Rated impulse withstand voltage $U_{imp.}$ (1.2/50 μ s)	4 kV
Overvoltage category	III
Pollution degree	3
Data acc. to IEC/EN 60898-1	
Rated operational voltage U_e	1P: 230/400 VAC; 1P+NP: 230 VAC ; 2...3P: 400 VAC; 3P+NP: 400 VAC; 1P 72 VDC; 2P 125 VDC
Min. operating voltage	12 VAC
Rated short-circuit capacity I_{cn}	10 kA
Energy limiting class	3
Reference Ambient Air Temperature for Overload Tripping	B, C: 30 °C
Mechanical Data	
Classification acc. To NF F 126-101, NF F 16-102	Acc. to I2/F3
IP Code	IP20, IP40 in enclosure with cover
Endurance	Electrical endurance: 10 000 ops Mechanical endurance: 10 000 ops
Shock resistance acc. to IEC/EN 61373	5 g – 30 ms, 3 shocks
Vibration resistance acc. to IEC/EN 60068-2-6	2...13.2 Hz / 1 mm 13.2...100 Hz / 0.7 g, 5 cycles 5...150...5 Hz / 1 g, 4 waves
Ambient temperature	-25...+60 °C
Storage temperature	-40...+70 °C
Installation	
Terminal type	Failsafe bi-directional cylinder-lift terminal (shock protected)
Terminal rigid IEC connections (solid/stranded)	Single: 0.75 ... 35 mm ² (front slot), 0.75 ... 6 mm ² (rear slot) Multiple: 2x0.75 ... 10 mm ² (front slot), 2x0.75 ... 6 mm ² (rear slot), with cables of same type and size
Terminal flexible IEC connections	Single: 0.75 ... 25 mm ² (front side), 0.75 ... 6 mm ² (rear slot) Multiple: 2x0.75 ... 10 mm ² (front slot), 2x0.75 ... 6 mm ² (rear slot), with cables of same type and size
Tightening torque	2.8 Nm
Screwdriver	No. 2 Pozidrive
Mounting	Plug in on bus bar system SMISLINE
Mounting position	Any
Supply	Any
Dimensions and weight	
Pole dimensions (HxDxW)	91 x 18 x 82
Pole weight	110 g

Miniature circuit breaker (MCB)

S400E 6 kA



B according to EN 60898-1

	I_{cn} [kA]	I_n [A]	Type name	ABB IT number	EAN number 761227	Pack- aging unit	Module	Weight in grams
 <p>S401E</p> <p>1 2</p>	6	6	S401E-B6	2CCS551001R0065	0101009	10	1	110
	6	8	S401E-B8	2CCS551001R0085	0108442	10	1	110
	6	10	S401E-B10	2CCS551001R0105	0101016	10	1	110
	6	13	S401E-B13	2CCS551001R0135	0101023	10	1	110
	6	16	S401E-B16	2CCS551001R0165	0101030	10	1	110
	6	20	S401E-B20	2CCS551001R0205	0101047	10	1	110
	6	25	S401E-B25	2CCS551001R0255	0101054	10	1	110
	6	32	S401E-B32	2CCS551001R0325	0101061	10	1	110
	6	40	S401E-B40	2CCS551001R0405	0101078	10	1	110
	6	50	S401E-B50	2CCS551001R0505	0101085	10	1	110
6	63	S401E-B63	2CCS551001R0635	0101092	10	1	110	
 <p>S402E</p> <p>1 3 2 4</p>	6	6	S402E-B6	2CCS552001R0065	0101771	5	2	221
	6	8	S402E-B8	2CCS552001R0085	010 8459	5	2	221
	6	10	S402E-B10	2CCS552001R0105	0101788	5	2	221
	6	13	S402E-B13	2CCS552001R0135	0101795	5	2	221
	6	16	S402E-B16	2CCS552001R0165	0101801	5	2	221
	6	20	S402E-B20	2CCS552001R0205	0101818	5	2	221
	6	25	S402E-B25	2CCS552001R0255	0101825	5	2	221
	6	32	S402E-B32	2CCS552001R0325	0101832	5	2	221
	6	40	S402E-B40	2CCS552001R0405	0101849	5	2	221
	6	50	S402E-B50	2CCS552001R0505	0101856	5	2	221
6	63	S402E-B63	2CCS552001R0635	0101863	5	2	221	
 <p>S403E</p> <p>1 3 5 2 4 6</p>	6	6	S403E-B6	2CCS553001R0065	0102549	3	3	322
	6	8	S403E-B8	2CCS553001R0085	0108466	3	3	322
	6	10	S403E-B10	2CCS553001R0105	0102556	3	3	322
	6	13	S403E-B13	2CCS553001R0135	0102563	3	3	322
	6	16	S403E-B16	2CCS553001R0165	0102570	3	3	322
	6	20	S403E-B20	2CCS553001R0205	0102587	3	3	322
	6	25	S403E-B25	2CCS553001R0255	0102594	3	3	322
	6	32	S403E-B32	2CCS553001R0325	0102600	3	3	322
	6	40	S403E-B40	2CCS553001R0405	0102617	3	3	322
	6	50	S403E-B50	2CCS553001R0505	0102624	3	3	322
6	63	S403E-B63	2CCS553001R0635	0102631	3	3	322	

Miniature circuit breaker (MCB)

S400E 6 kA





C according to EN 60898-1

	I_{cn} [kA]	I_n [A]	Type name	ABB IT number	EAN number 761227	Pack- aging unit	Module	Weight in grams
 <p>S401E</p> <p>1 2</p>	6	6	S401E-C6	2CCS551001R0064	0101108	10	1	110
	6	8	S401E-C8	2CCS551001R0084	0101115	10	1	110
	6	10	S401E-C10	2CCS551001R0104	0101122	10	1	110
	6	13	S401E-C13	2CCS551001R0134	0101139	10	1	110
	6	16	S401E-C16	2CCS551001R0164	0101146	10	1	110
	6	20	S401E-C20	2CCS551001R0204	0101153	10	1	110
	6	25	S401E-C25	2CCS551001R0254	0101160	10	1	110
	6	32	S401E-C32	2CCS551001R0324	0101177	10	1	110
	6	40	S401E-C40	2CCS551001R0404	0101184	10	1	110
	6	50	S401E-C50	2CCS551001R0504	0101191	10	1	110
6	63	S401E-C63	2CCS551001R0634	0101207	10	1	110	
 <p>S402E</p> <p>1 3 2 4</p>	6	6	S402E-C6	2CCS552001R0064	0101870	5	2	221
	6	8	S402E-C8	2CCS552001R0084	0101887	5	2	221
	6	10	S402E-C10	2CCS552001R0104	0101894	5	2	221
	6	13	S402E-C13	2CCS552001R0134	0101900	5	2	221
	6	16	S402E-C16	2CCS552001R0164	0101917	5	2	221
	6	20	S402E-C20	2CCS552001R0204	0101924	5	2	221
	6	25	S402E-C25	2CCS552001R0254	0101931	5	2	221
	6	32	S402E-C32	2CCS552001R0324	0101948	5	2	221
	6	40	S402E-C40	2CCS552001R0404	0101955	5	2	221
	6	50	S402E-C50	2CCS552001R0504	0101962	5	2	221
6	63	S402E-C63	2CCS552001R0634	0101979	5	2	221	
 <p>S403E</p> <p>1 3 5 2 4 6</p>	6	6	S403E-C6	2CCS553001R0064	0102648	3	3	322
	6	8	S403E-C8	2CCS553001R0084	0102655	3	3	322
	6	10	S403E-C10	2CCS553001R0104	0102662	3	3	322
	6	13	S403E-C13	2CCS553001R0134	0102679	3	3	322
	6	16	S403E-C16	2CCS553001R0164	0102686	3	3	322
	6	20	S403E-C20	2CCS553001R0204	0102693	3	3	322
	6	25	S403E-C25	2CCS553001R0254	0102709	3	3	322
	6	32	S403E-C32	2CCS553001R0324	0102716	3	3	322
	6	40	S403E-C40	2CCS553001R0404	0102723	3	3	322
	6	50	S403E-C50	2CCS553001R0504	0102730	3	3	322
6	63	S403E-C63	2CCS553001R0634	0102747	3	3	322	

Miniature circuit breaker (MCB)

S400E with protected neutral 6 kA

C according to EN 60898-1

	I_{cn} [kA]	I_n [A]	Type name	ABB IT number	EAN number 761227	Pack- aging unit	Module	Weight in grams
 <p>S401 E NP</p> 	6	10	S401E-C10NP	2CCS551103R8104	1442750	5	2	221
	6	13	S401E-C13NP	2CCS551103R8134	1442767	5	2	221
	6	16	S401E-C16NP	2CCS551103R8164	1442774	5	2	221
	6	20	S401E-C20NP	2CCS551103R8204	1442781	5	2	221
	6	25	S401E-C25NP	2CCS551103R8254	1442798	5	2	221
	6	32	S401E-C32NP	2CCS551103R8324	1442804	5	2	221
	6	40	S401E-C40NP	2CCS551103R8404	1442811	5	2	221
	6	50	S401E-C50NP	2CCS551103R8504	1442828	5	2	221
	6	63	S401E-C63NP	2CCS551103R8634	1442835	5	2	221
 <p>S403 E NP</p> 	6	10	S403E-C10NP	2CCS553103R8104	1442842	2	4	428
	6	13	S403E-C13NP	2CCS553103R8134	1442859	2	4	428
	6	16	S403E-C16NP	2CCS553103R8164	1442866	2	4	428
	6	20	S403E-C20NP	2CCS553103R8204	1442873	2	4	428
	6	25	S403E-C25NP	2CCS553103R8254	1442880	2	4	428
	6	32	S403E-C32NP	2CCS553103R8324	1442897	2	4	428
	6	40	S403E-C40NP	2CCS553103R8404	1442903	2	4	428
	6	50	S403E-C50NP	2CCS553103R8504	1442910	2	4	428
	6	63	S403E-C63NP	2CCS553103R8634	1443009	2	4	428

SMISLINE TP plug-in system

MCBs S 400M and UC series

		S400M and S400 UC	
General Data			IEC/EN 60898-1 S400 B,C,D,K°, IEC/EN 60947-2 S400 C,K,UCC, UCK
	Poles		1P, 1P+NP, 2P, 3P, 3P+NP
	Tripping characteristics		B,C,D,K, UCC, UCZ
	Rated current I _n	A	0.5 ... 63
	Rated frequency f	Hz	50/60 Hz (162/3 on request)
	Rated insulation voltage U _i acc. to DIN EN 60664-1	V	400 VAC
	Rated impulse withstand voltage U _{imp} (1.2/50 μs)	kV	4 kV
	Overvoltage category		III
	Pollution degree		2
Data acc. to IEC/EN 60898-1	Rated operational voltage U _e	V	1P: 230/400V AC; 1P+N: 230V AC; 2...4P: 400V AC; 3P+N: 400V AC; 1P 72 V DC; 2P 125 V DC
	Max. power frequency recovery voltage (U _{max})	V	1P: 253V AC; 1P+N: 253V AC; 2P: 440V AC; 3...4P: 440V AC; 3P+N: 440V AC; 1P: 72 V DC; 2P: 125V DC
	Rated short-circuit capacity I _{cn}	kA	6kA S400E 10kA S400M
	Energy limiting class		3
	Reference temperature for tripping characteristics	°C	B, C, D: 30 °C
	Electrical and Mechanical Endurance	ops.	10000 ops.
Data acc. to IEC/EN 60947-2	Max. power frequency recovery voltage (U _{max})	V	254/440V AC 1P: 60V DC 2P: 125V DC for S400M 1P: 125V DC 2P: 250V DC for S400 UCC and UCZ
	Rated ultimate short-circuit capacity I _{cu}	kA	25 kA (0,5 up to 16 A, 240/415 V) 0,5 to 2 A 50 kA on request 15 kA (20 up to 63 A, 240/415 V) 15 kA (0,5 up to 16 A, 254/440 V) 6 kA (20 up to 63 A, 254/440 V) S400UC: 10 kA (0,5.63A, 220 V d.c. 1pole) S400UC: 20 kA (0,5.63A, 110 V d.c. 1pole) S400UC: 25 kA (0,5.63A, 220 V d.c. 2pole) S400UC: 10 kA (0,5.63A, 440 V d.c. 2pole) S400UC: 10 kA (0,5.63A, 230/400 V)
	Rated service short-circuit capacity I _{cs}	kA	15 kA (0,5 up to 16 A, 240/415 V) 7,5 kA (20 up to 63 A, 240/415 V) 6 kA (0,5 up to 16 A, 254/440 V) 3 kA (20 up to 63 A, 254/440 V) S400UC: 10 kA (0,5.63A, 220 V d.c. 1pole) S400UC: 10 kA (0,5.63A, 110 V d.c. 1pole) S400UC: 20 kA (0,5.63A, 220 V d.c. 2pole) S400UC: 10 kA (0,5.63A, 440 V d.c. 2pole) S400UC: 6 kA (0,5.63A, 230/400 V)
	Reference temperature for tripping characteristics	°C	C: 30°C K: 40°C
	Electrical and Mechanical Endurance	ops.	10 000 operating cycles
	Mechanical Data	Housing	
Toggle			Insulation group II, black, sealable
Classification acc. To NF F 126-101, NF F 16-102			
Protection degree acc. to EN 60529			IP20*, IP40 in enclosure with cover
Mechanical endurance		ops.	20000 ops.
Shock resistance acc. to IEC/EN 60068-2-30			
Vibration resistance acc. to IEC/EN 60068-2-6			5g – 20 cycles at 5 ... 150 ... 5 Hz with load 0.8I _n
Environmental conditions (damp heat) acc. to IEC/EN 60068-2-30		°C/RH	28 cycles with 55 °C/90–96% and 25 °C/95–100%
Ambient temperature		°C	–25 ...+60 °C
Storage temperature		°C	–40 ... +70 °C
Installation	Standed Cross-section of conductors (top/bottom)	mm ²	Single: 0.75...35 mm ² (front slot), 0.75...6 mm ² (rear slot) Multiple: 2 x 0.75...10 mm ² (front slot), 2 x 0.75...6 mm ² (rear slot), with cables of same type and size
	Flexible Cross-section of conductors (top/bottom)	mm ²	Single: 0.75...25 mm ² (front side), 0.75...6 mm ² (rear slot) Multiple: 2 x 0.75...10 mm ² (front slot), 2 x 0.75...6 mm ² (rear slot), with cables of same type and size
	Tightening torque	Nm in-lbs.	2.8Nm
	Screwdriver		No. 2 Pozidrive
	Mounting		plug in on bus bar system SMISLINE
	Mounting position		any
Dimensions and weight	Supply		any
	Mounting dimensions acc. to DIN 43880		
	Pole dimensions (H x D x W)	mm	91x18x82
	Pole weight	g	110

SMISLINE TP plug-in system

MCBs S 400 M series 10000 B characteristic



S 401 M



S 402 M



S 403 M

S400M Characteristic B

Function: protection and control of the circuits against overloads and short-circuits; protection for people and big length cables in TN and IT systems.

Applications: residential, commercial and industrial.

Standard: IEC/EN 60898

Icn=10kA

Number of poles	Rated current	Bbn 761227	Order details		Price 1 piece	Weight 1 piece	Pack unit
			In A	EAN			
1	4	0101214	S401 M-B 4	2CCS571001R0045		0.110	10
	6	0101221	S401 M-B 6	2CCS571001R0065		0.110	10
	8	0108411	S401 M-B 8	2CCS571001R0085		0.110	10
	10	0101238	S401 M-B 10	2CCS571001R0105		0.110	10
	13	0101245	S401 M-B 13	2CCS571001R0135		0.110	10
	16	0101252	S401 M-B 16	2CCS571001R0165		0.110	10
	20	0101269	S401 M-B 20	2CCS571001R0205		0.110	10
	25	0101276	S401 M-B 25	2CCS571001R0255		0.110	10
	32	0101283	S401 M-B 32	2CCS571001R0325		0.110	10
	40	0101290	S401 M-B 40	2CCS571001R0405		0.110	10
	50	0101306	S401 M-B 50	2CCS571001R0505		0.110	10
63	0101313	S401 M-B 63	2CCS571001R0635		0.110	10	
2	4	0101986	S402 M-B 4	2CCS572001R0045		0.221	5
	6	0101993	S402 M-B 6	2CCS572001R0065		0.221	5
	8	0108428	S402 M-B 8	2CCS572001R0085		0.221	5
	10	0102006	S402 M-B 10	2CCS572001R0105		0.221	5
	13	0102013	S402 M-B 13	2CCS572001R0135		0.221	5
	16	0102020	S402 M-B 16	2CCS572001R0165		0.221	5
	20	0102037	S402 M-B 20	2CCS572001R0205		0.221	5
	25	0102044	S402 M-B 25	2CCS572001R0255		0.221	5
	32	0102051	S402 M-B 32	2CCS572001R0325		0.221	5
	40	0102068	S402 M-B 40	2CCS572001R0405		0.221	5
	50	0102075	S402 M-B 50	2CCS572001R0505		0.221	5
63	0102082	S402 M-B 63	2CCS572001R0635		0.221	5	
3	4	0102754	S403 M-B 4	2CCS573001R0045		0.322	3
	6	0102761	S403 M-B 6	2CCS573001R0065		0.322	3
	8	0108435	S403 M-B 8	2CCS573001R0085		0.322	3
	10	0102778	S403 M-B 10	2CCS573001R0105		0.322	3
	13	0102785	S403 M-B 13	2CCS573001R0135		0.322	3
	16	0102792	S403 M-B 16	2CCS573001R0165		0.322	3
	20	0102808	S403 M-B 20	2CCS573001R0205		0.322	3
	25	0102815	S403 M-B 25	2CCS573001R0255		0.322	3
	32	0102822	S403 M-B 32	2CCS573001R0325		0.322	3
	40	0102839	S403 M-B 40	2CCS573001R0405		0.322	3
	50	0102846	S403 M-B 50	2CCS573001R0505		0.322	3
63	0102853	S403 M-B 63	2CCS573001R0635		0.322	3	

SMISLINE TP plug-in system

MCBs S 400 M series 10000 C characteristic



S401 M



S 402 M



S 403 M

S400M Characteristic C

Function: protection and control of the circuits against overloads and short-circuits; protection for resistive and inductive loads with low inrush current.

Applications: residential, commercial and industrial.

Standard: IEC/EN 60898, IEC/EN 60947-2

Icn=10kA

Number of poles	Rated current In A	Bbn 761227 EAN	Order details		Price 1 piece	Weight 1 piece kg	Pack unit pc.
			Type code	Order code			
1	0.5	0101320	S401 M-C 0.5	2CCS571001R0984		0.110	10
	1	0101337	S401 M-C 1	2CCS571001R0014		0.110	10
	1.6	0101344	S401 M-C 1.6	2CCS571001R0974		0.110	10
	2	0101351	S401 M-C 2	2CCS571001R0024		0.110	10
	3	0101368	S401 M-C 3	2CCS571001R0034		0.110	10
	4	0101375	S401 M-C 4	2CCS571001R0044		0.110	10
	6	0101382	S401 M-C 6	2CCS571001R0064		0.110	10
	8	0101399	S401 M-C 8	2CCS571001R0084		0.110	10
	10	0101405	S401 M-C 10	2CCS571001R0104		0.110	10
	13	0101412	S401 M-C 13	2CCS571001R0134		0.110	10
	16	0101429	S401 M-C 16	2CCS571001R0164		0.110	10
	20	0101436	S401 M-C 20	2CCS571001R0204		0.110	10
	25	0101443	S401 M-C 25	2CCS571001R0254		0.110	10
	32	0101450	S401 M-C 32	2CCS571001R0324		0.110	10
	40	0101467	S401 M-C 40	2CCS571001R0404		0.110	10
50	0101474	S401 M-C 50	2CCS571001R0504		0.110	10	
63	0101481	S401 M-C 63	2CCS571001R0634		0.110	10	
2	0.5	0102099	S402 M-C 0.5	2CCS572001R0984		0.221	5
	1	0102105	S402 M-C 1	2CCS572001R0014		0.221	5
	1.6	0102112	S402 M-C 1.6	2CCS572001R0974		0.221	5
	2	0102129	S402 M-C 2	2CCS572001R0024		0.221	5
	3	0102136	S402 M-C 3	2CCS572001R0034		0.221	5
	4	0102143	S402 M-C 4	2CCS572001R0044		0.221	5
	6	0102150	S402 M-C 6	2CCS572001R0064		0.221	5
	8	0102167	S402 M-C 8	2CCS572001R0084		0.221	5
	10	0102174	S402 M-C 10	2CCS572001R0104		0.221	5
	13	0102181	S402 M-C 13	2CCS572001R0134		0.221	5
	16	0102198	S402 M-C 16	2CCS572001R0164		0.221	5
	20	0102204	S402 M-C 20	2CCS572001R0204		0.221	5
	25	0102211	S402 M-C 25	2CCS572001R0254		0.221	5
	32	0102228	S402 M-C 32	2CCS572001R0324		0.221	5
	40	0102235	S402 M-C 40	2CCS572001R0404		0.221	5
50	0102242	S402 M-C 50	2CCS572001R0504		0.221	5	
63	0102259	S402 M-C 63	2CCS572001R0634		0.221	5	
3	0.5	0102860	S403 M-C 0.5	2CCS573001R0984		0.322	3
	1	0102877	S403 M-C 1	2CCS573001R0014		0.322	3
	1.6	0102884	S403 M-C 1.6	2CCS573001R0974		0.322	3
	2	0102891	S403 M-C 2	2CCS573001R0024		0.322	3
	3	0102907	S403 M-C 3	2CCS573001R0034		0.322	3
	4	0102914	S403 M-C 4	2CCS573001R0044		0.322	3
	6	0102921	S403 M-C 6	2CCS573001R0064		0.322	3
	8	0102938	S403 M-C 8	2CCS573001R0084		0.322	3
	10	0102945	S403 M-C 10	2CCS573001R0104		0.322	3
	13	0102952	S403 M-C 13	2CCS573001R0134		0.322	3
	16	0102969	S403 M-C 16	2CCS573001R0164		0.322	3
	20	0102976	S403 M-C 20	2CCS573001R0204		0.322	3
	25	0102983	S403 M-C 25	2CCS573001R0254		0.322	3
	32	0102990	S403 M-C 32	2CCS573001R0324		0.322	3
	40	0103003	S403 M-C 40	2CCS573001R0404		0.322	3
50	0103010	S403 M-C 50	2CCS573001R0504		0.322	3	
63	0103027	S403 M-C 63	2CCS573001R0634		0.322	3	

SMISLINE TP plug-in system

MCBs S 400 M series 10000 D characteristic



S 401 M



S 402 M



S 403 M

S400M Characteristic D

Function: protection and control of the circuits against overloads and short-circuits; protection for circuits which supply loads with high inrush current at the circuit closing (LV/LV transformers, breakdown lamps).

Applications: residential, commercial and industrial.

Standard: IEC/EN 60898

Icn=10kA

Number of poles	Rated current In A	Bbn 761227 EAN	Order details		Price 1 piece	Weight 1 piece kg	Pack unit pc.	
			Type code	Order code				
1	6	0101498	S401 M-D 6	2CCS571001R0061		0.110	10	
	8	0101504	S401 M-D 8	2CCS571001R0081		0.110	10	
	10	0101511	S401 M-D 10	2CCS571001R0101		0.110	10	
	13	0101528	S401 M-D 13	2CCS571001R0131		0.110	10	
	16	0101535	S401 M-D 16	2CCS571001R0161		0.110	10	
	20	0101542	S401 M-D 20	2CCS571001R0201		0.110	10	
	25	0101559	S401 M-D 25	2CCS571001R0251		0.110	10	
	32	0101566	S401 M-D 32	2CCS571001R0321		0.110	10	
	40	0101573	S401 M-D 40	2CCS571001R0401		0.110	10	
	50	0101580	S401 M-D 50	2CCS571001R0501		0.110	10	
	63	0101597	S401 M-D 63	2CCS571001R0631		0.110	10	
	2	6	0102266	S402 M-D 6	2CCS572001R0061		0.221	5
		8	0102273	S402 M-D 8	2CCS572001R0081		0.221	5
10		0102280	S402 M-D 10	2CCS572001R0101		0.221	5	
13		0102297	S402 M-D 13	2CCS572001R0131		0.221	5	
16		0102303	S402 M-D 16	2CCS572001R0161		0.221	5	
20		0102310	S402 M-D 20	2CCS572001R0201		0.221	5	
25		0102327	S402 M-D 25	2CCS572001R0251		0.221	5	
32		0102334	S402 M-D 32	2CCS572001R0321		0.221	5	
40		0102341	S402 M-D 40	2CCS572001R0401		0.221	5	
50		0102358	S402 M-D 50	2CCS572001R0501		0.221	5	
63		0102365	S402 M-D 63	2CCS572001R0631		0.221	5	
3		6	0103034	S403 M-D 6	2CCS573001R0061		0.322	3
		8	0103041	S403 M-D 8	2CCS573001R0081		0.322	3
	10	0103058	S403 M-D 10	2CCS573001R0101		0.322	3	
	13	0103065	S403 M-D 13	2CCS573001R0131		0.322	3	
	16	0103072	S403 M-D 16	2CCS573001R0161		0.322	3	
	20	0103089	S403 M-D 20	2CCS573001R0201		0.322	3	
	25	0103096	S403 M-D 25	2CCS573001R0251		0.322	3	
	32	0103102	S403 M-D 32	2CCS573001R0321		0.322	3	
	40	0103119	S403 M-D 40	2CCS573001R0401		0.322	3	
	50	0103126	S403 M-D 50	2CCS573001R0501		0.322	3	
	63	0103133	S403 M-D 63	2CCS573001R0631		0.322	3	

SMISLINE TP plug-in system

MCBs S 400 M series 5000-15000 K characteristic



S401 M



S 402 M



S 403 M

S400M Characteristic K

Function: protection and control of the circuits like motors, transformer and auxiliary circuits, against overloads and short-circuits. Advantages: no nuisance tripping in the case of functional peak currents up to 10xIn, depending on the series; through its highly sensitive thermostatic bimetal trip, the K-type characteristic offers protection to damageable elements in the overcurrent range; it also provides the best protection to cables and lines.

Applications: commercial and industrial.

Standard: IEC/EN 60947-2

Icu = 50 kA ≤ 2A, 25 kA for 3 A ≤ 16A, 15 kA for 32 A ≤ 63 A

Number of poles	Rated current In A	Bbn 761227 EAN	Order details		Price 1 piece	Weight 1 piece kg	Pack unit pc.
			Type code	Order code			
1	0.5	0101603	S401 M-K 0.5	2CCS571001R0157		0.110	10
	1	0101610	S401 M-K 1	2CCS571001R0217		0.110	10
	1.6	0101627	S401 M-K 1.6	2CCS571001R0257		0.110	10
	2	0101634	S401 M-K 2	2CCS571001R0277		0.110	10
	3	0101641	S401 M-K 3	2CCS571001R0317		0.110	10
	4	0101658	S401 M-K 4	2CCS571001R0337		0.110	10
	6	0101665	S401 M-K 6	2CCS571001R0377		0.110	10
	8	0101672	S401 M-K 8	2CCS571001R0407		0.110	10
	10	0101689	S401 M-K 10	2CCS571001R0427		0.110	10
	13	0101696	S401 M-K 13	2CCS571001R0447		0.110	10
	16	0101702	S401 M-K 16	2CCS571001R0467		0.110	10
	20	0101719	S401 M-K 20	2CCS571001R0487		0.110	10
	25	0101726	S401 M-K 25	2CCS571001R0517		0.110	10
	32	0101733	S401 M-K 32	2CCS571001R0537		0.110	10
	40	0101740	S401 M-K 40	2CCS571001R0557		0.110	10
50	0101757	S401 M-K 50	2CCS571001R0577		0.110	10	
63	0101764	S401 M-K 63	2CCS571001R0597		0.110	10	
2	0.5	0102372	S402 M-K 0.5	2CCS572001R0157		0.221	5
	1	0102389	S402 M-K 1	2CCS572001R0217		0.221	5
	1.6	0102396	S402 M-K 1.6	2CCS572001R0257		0.221	5
	2	0102402	S402 M-K 2	2CCS572001R0277		0.221	5
	3	0102419	S402 M-K 3	2CCS572001R0317		0.221	5
	4	0102426	S402 M-K 4	2CCS572001R0337		0.221	5
	6	0102433	S402 M-K 6	2CCS572001R0377		0.221	5
	8	0102440	S402 M-K 8	2CCS572001R0407		0.221	5
	10	0102457	S402 M-K 10	2CCS572001R0427		0.221	5
	13	0102464	S402 M-K 13	2CCS572001R0447		0.221	5
	16	0102471	S402 M-K 16	2CCS572001R0467		0.221	5
	20	0102488	S402 M-K 20	2CCS572001R0487		0.221	5
	25	0102495	S402 M-K 25	2CCS572001R0517		0.221	5
	32	0102501	S402 M-K 32	2CCS572001R0537		0.221	5
	40	0102518	S402 M-K 40	2CCS572001R0557		0.221	5
50	0102525	S402 M-K 50	2CCS572001R0577		0.221	5	
63	0102532	S402 M-K 63	2CCS572001R0597		0.221	5	
3	0.5	0103140	S403 M-K 0.5	2CCS573001R0157		0.322	3
	1	0103157	S403 M-K 1	2CCS573001R0217		0.322	3
	1.6	0103164	S403 M-K 1.6	2CCS573001R0257		0.322	3
	2	0103171	S403 M-K 2	2CCS573001R0277		0.322	3
	3	0103188	S403 M-K 3	2CCS573001R0317		0.322	3
	4	0103195	S403 M-K 4	2CCS573001R0337		0.322	3
	6	0103201	S403 M-K 6	2CCS573001R0377		0.322	3
	8	0103218	S403 M-K 8	2CCS573001R0407		0.322	3
	10	0103225	S403 M-K 10	2CCS573001R0427		0.322	3
	13	0103232	S403 M-K 13	2CCS573001R0447		0.322	3
	16	0103249	S403 M-K 16	2CCS573001R0467		0.322	3
	20	0103256	S403 M-K 20	2CCS573001R0487		0.322	3
	25	0103263	S403 M-K 25	2CCS573001R0517		0.322	3
	32	0103270	S403 M-K 32	2CCS573001R0537		0.322	3
	40	0103287	S403 M-K 40	2CCS573001R0557		0.322	3
50	0103294	S403 M-K 50	2CCS573001R0577		0.322	3	
63	0103300	S403 M-K 63	2CCS573001R0597		0.322	3	

SMISLINE TP plug-in system

MCBs S 400 M series 10000 B characteristic



S401M-NP



S403M-NP

S400M Characteristic B-NP

Function: protection and control of the circuits against overloads and short-circuits; protection for people and big length cables in TN and IT systems. The neutral is full protected.

Applications: residential, commercial and industrial.

Standard: IEC/EN 60898

Icn=10kA

Number of poles	Rated current In A	Bbn 761227 EAN	Order details		Price 1 piece	Weight 1 piece kg	Pack unit pc.
			Type code	Order code			
2	6	0103317	S401 M-B 6NP	2CCS571103R8065		0.221	5
	8	0108473	S401 M-B 8NP	2CCS571103R8085		0.221	5
	10	0103324	S401 M-B 10NP	2CCS571103R8105		0.221	5
	13	0103331	S401 M-B 13NP	2CCS571103R8135		0.221	5
	16	0103348	S401 M-B 16NP	2CCS571103R8165		0.221	5
	20	0103355	S401 M-B 20NP	2CCS571103R8205		0.221	5
	25	0103362	S401 M-B 25NP	2CCS571103R8255		0.221	5
	32	0103379	S401 M-B 32NP	2CCS571103R8325		0.221	5
	40	0103386	S401 M-B 40NP	2CCS571103R8405		0.221	5
	50	0103393	S401 M-B 50NP	2CCS571103R8505		0.221	5
	63	0103409	S401 M-B 63NP	2CCS571103R8635		0.221	5
4	6	0103782	S403 M-B 6NP	2CCS573103R8065		0.428	2
	8	0108510	S403 M-B 8NP	2CCS573103R8085		0.428	2
	10	0103799	S403 M-B 10NP	2CCS573103R8105		0.428	2
	13	0103805	S403 M-B 13NP	2CCS573103R8135		0.428	2
	16	0103812	S403 M-B 16NP	2CCS573103R8165		0.428	2
	20	0103829	S403 M-B 20NP	2CCS573103R8205		0.428	2
	25	0103836	S403 M-B 25NP	2CCS573103R8255		0.428	2
	32	0103843	S403 M-B 32NP	2CCS573103R8325		0.428	2
	40	0103850	S403 M-B 40NP	2CCS573103R8405		0.428	2
	50	0103867	S403 M-B 50NP	2CCS573103R8505		0.428	2
	63	0103874	S403 M-B 63NP	2CCS573103R8635		0.428	2

SMISLINE TP plug-in system

MCBs S 400 M series 10000 C characteristic



S401M-NP



S403M-NP

S400M Characteristic C-NP

Function: protection and control of the circuits against overloads and short-circuits; protection for resistive and inductive loads with low inrush current. The neutral is full protected.

Applications: residential, commercial and industrial.

Standard: IEC/EN 60898, IEC/EN 60947-2

I_{cn}=10kA

Number of poles	Rated current In A	Bbn 761227 EAN	Order details		Price 1 piece	Weight 1 piece kg	Pack unit pc.
			Type code	Order code			
2	2	0108480	S401 M-C 2NP	2CCS571103R8024		0.221	5
	3	0108497	S401 M-C 3NP	2CCS571103R8034		0.221	5
	4	0108503	S401 M-C 4NP	2CCS571103R8044		0.221	5
	6	0103416	S401 M-C 6NP	2CCS571103R8064		0.221	5
	8	0103423	S401 M-C 8NP	2CCS571103R8084		0.221	5
	10	0103430	S401 M-C 10NP	2CCS571103R8104		0.221	5
	13	0103447	S401 M-C 13NP	2CCS571103R8134		0.221	5
	16	0103454	S401 M-C 16NP	2CCS571103R8164		0.221	5
	20	0103461	S401 M-C 20NP	2CCS571103R8204		0.221	5
	25	0103478	S401 M-C 25NP	2CCS571103R8254		0.221	5
	32	0103485	S401 M-C 32NP	2CCS571103R8324		0.221	5
	40	0103492	S401 M-C 40NP	2CCS571103R8404		0.221	5
	50	0103508	S401 M-C 50NP	2CCS571103R8504		0.221	5
	63	0103515	S401 M-C 63NP	2CCS571103R8634		0.221	5
4	2	0108527	S403 M-C 2NP	2CCS573103R8024		0.428	2
	3	0108534	S403 M-C 3NP	2CCS573103R8034		0.428	2
	4	0108541	S403 M-C 4NP	2CCS573103R8044		0.428	2
	6	0103881	S403 M-C 6NP	2CCS573103R8064		0.428	2
	8	0103898	S403 M-C 8NP	2CCS573103R8084		0.428	2
	10	0103904	S403 M-C 10NP	2CCS573103R8104		0.428	2
	13	0103911	S403 M-C 13NP	2CCS573103R8134		0.428	2
	16	0103928	S403 M-C 16NP	2CCS573103R8164		0.428	2
	20	0103935	S403 M-C 20NP	2CCS573103R8204		0.428	2
	25	0103942	S403 M-C 25NP	2CCS573103R8254		0.428	2
	32	0103959	S403 M-C 32NP	2CCS573103R8324		0.428	2
	40	0103966	S403 M-C 40NP	2CCS573103R8404		0.428	2
	50	0103973	S403 M-C 50NP	2CCS573103R8504		0.428	2
	63	0103980	S403 M-C 63NP	2CCS573103R8634		0.428	2

SMISLINE TP plug-in system

MCBs S 400 M series 10000 D characteristic



S401M -NP



S403M -NP

S400M Characteristic D-NP

Function: protection and control of the circuits against overloads and short-circuits; protection for circuits which supply loads with high inrush current at the circuit closing (LV/LV transformers, breakdown lamps). The neutral is full protected.

Applications: residential, commercial and industrial.

Standard: IEC/EN 60898

Icn=10kA

Number of poles	Rated current In A	Bbn 761227 EAN	Order details		Price 1 piece	Weight 1 piece kg	Pack unit pc.
			Type code	Order code			
2	10	0103522	S401 M-D 10NP	2CCS571103R8101		0.221	5
	13	0103539	S401 M-D 13NP	2CCS571103R8131		0.221	5
	16	0103546	S401 M-D 16NP	2CCS571103R8161		0.221	5
	20	0103553	S401 M-D 20NP	2CCS571103R8201		0.221	5
	25	0103560	S401 M-D 25NP	2CCS571103R8251		0.221	5
	32	0103577	S401 M-D 32NP	2CCS571103R8321		0.221	5
	40	0103584	S401 M-D 40NP	2CCS571103R8401		0.221	5
	50	0103591	S401 M-D 50NP	2CCS571103R8501		0.221	5
	63	0103607	S401 M-D 63NP	2CCS571103R8631		0.221	5
4	10	0103997	S403 M-D 10NP	2CCS573103R8101		0.428	2
	13	0104000	S403 M-D 13NP	2CCS573103R8131		0.428	2
	16	0104017	S403 M-D 16NP	2CCS573103R8161		0.428	2
	20	0104024	S403 M-D 20NP	2CCS573103R8201		0.428	2
	25	0104031	S403 M-D 25NP	2CCS573103R8251		0.428	2
	32	0104048	S403 M-D 32NP	2CCS573103R8321		0.428	2
	40	0104055	S403 M-D 40NP	2CCS573103R8401		0.428	2
	50	0104062	S403 M-D 50NP	2CCS573103R8501		0.428	2
	63	0104079	S403 M-D 63NP	2CCS573103R8631		0.428	2

SMISLINE TP plug-in system

MCBs S 400 M series 5 000-15 000 K characteristic



S401M - NP



S403M - NP

S400M Characteristic K-NP

Function: protection and control of the circuits like motors, transformer and auxiliary circuits, against overloads and short-circuits.

Advantages: no nuisance tripping in the case of functional peak currents up to 10xIn, depending on the series; through its highly sensitive thermostatic bimetal trip, the K-type characteristic offers protection to damageable elements in the overcurrent range; it also provides the best protection to cables and lines. The neutral is full protected.

Applications: commercial and industrial.

Standard: IEC/EN 60947-2

Icu = 50 kA ≤ 2A, 25 kA for 3 A ≤ 16A, 15 kA for 32 A ≤ 63 A

Number of poles	Rated current In A	Bbn 761227 EAN	Order details		Price 1 piece	Weight 1 piece kg	Pack unit pc.
			Type code	Order code			
2	0.5	0103614	S401 M-K 0.5NP	2CCS571103R8157		0.221	5
	1	0103621	S401 M-K 1NP	2CCS571103R8217		0.221	5
	1.6	0103638	S401 M-K 1.6NP	2CCS571103R8257		0.221	5
	2	0103645	S401 M-K 2NP	2CCS571103R8277		0.221	5
	3	0103652	S401 M-K 3NP	2CCS571103R8317		0.221	5
	4	0103669	S401 M-K 4NP	2CCS571103R8337		0.221	5
	6	0103676	S401 M-K 6NP	2CCS571103R8377		0.221	5
	8	0103683	S401 M-K 8NP	2CCS571103R8407		0.221	5
	10	0103690	S401 M-K 10NP	2CCS571103R8427		0.221	5
	13	0103706	S401 M-K 13NP	2CCS571103R8447		0.221	5
	16	0103713	S401 M-K 16NP	2CCS571103R8467		0.221	5
	20	0103720	S401 M-K 20NP	2CCS571103R8487		0.221	5
	25	0103737	S401 M-K 25NP	2CCS571103R8517		0.221	5
	32	0103744	S401 M-K 32NP	2CCS571103R8537		0.221	5
	40	0103751	S401 M-K 40NP	2CCS571103R8557		0.221	5
	50	0103768	S401 M-K 50NP	2CCS571103R8577		0.221	5
63	0103775	S401 M-K 63NP	2CCS571103R8597		0.221	5	
4	0.5	0104086	S403 M-K 0.5NP	2CCS573103R8157		0.428	2
	1	0104093	S403 M-K 1NP	2CCS573103R8217		0.428	2
	1.6	0104109	S403 M-K 1.6NP	2CCS573103R8257		0.428	2
	2	0104116	S403 M-K 2NP	2CCS573103R8277		0.428	2
	3	0104123	S403 M-K 3NP	2CCS573103R8317		0.428	2
	4	0104130	S403 M-K 4NP	2CCS573103R8337		0.428	2
	6	0104147	S403 M-K 6NP	2CCS573103R8377		0.428	2
	8	0104154	S403 M-K 8NP	2CCS573103R8407		0.428	2
	10	0104161	S403 M-K 10NP	2CCS573103R8427		0.428	2
	13	0104178	S403 M-K 13NP	2CCS573103R8447		0.428	2
	16	0104185	S403 M-K 16NP	2CCS573103R8467		0.428	2
	20	0104192	S403 M-K 20NP	2CCS573103R8487		0.428	2
	25	0104208	S403 M-K 25NP	2CCS573103R8517		0.428	2
	32	0104215	S403 M-K 32NP	2CCS573103R8537		0.428	2
	40	0104222	S403 M-K 40NP	2CCS573103R8557		0.428	2
	50	0104239	S403 M-K 50NP	2CCS573103R8577		0.428	2
63	0104246	S403 M-K 63NP	2CCS573103R8597		0.428	2	

SMISLINE TP plug-in system

MCBs S 400 M-UC series 10000-25000 C characteristic,
DC application



1 P 220V d.c.



2 P 440V d.c.

S400UC Characteristic C

Function: protection and control of the circuits against overloads and short-circuits; protection for resistive and inductive loads with low inrush current.

Applications: residential, commercial and industrial.

Standard: IEC/EN 60947-2

10 kA (0,5 up to 63 A, 220 V d.c. 1pole), 20 kA (0,5 up to 63 A, 110 V d.c. 1pole)

25 kA (0,5 up to 63 A, 220 V d.c. 2pole), 10 kA (0,5 up to 63 A, 440 V d.c. 2pole)

10 kA (0,5 up to 63 A, 230/400 V) a.c.

Number of poles	Rated current In A	Bbn 761227 EAN	Order details		Price 1 piece	Weight 1 piece kg	Pack unit pc.
			Type code	Order code			
1	0.5	0109746	S401M-UCC0.5	2CCS561001R1984		0.110	10
	1	0109753	S401M-UCC1	2CCS561001R1014		0.110	10
	1.6	0109760	S401M-UCC1.6	2CCS561001R1974		0.110	10
	2	0109777	S401M-UCC2	2CCS561001R1024		0.110	10
	3	0109784	S401M-UCC3	2CCS571001R1034		0.110	10
	4	0109791	S401M-UCC4	2CCS571001R1044		0.110	10
	6	0109807	S401M-UCC6	2CCS571001R1064		0.110	10
	8	0109814	S401M-UCC8	2CCS571001R1084		0.110	10
	10	0109821	S401M-UCC10	2CCS571001R1104		0.110	10
	13	0109838	S401M-UCC13	2CCS571001R1134		0.110	10
	16	0109845	S401M-UCC16	2CCS571001R1164		0.110	10
	20	0109852	S401M-UCC20	2CCS571001R1204		0.110	10
	25	0109869	S401M-UCC25	2CCS571001R1254		0.110	10
	32	0109876	S401M-UCC32	2CCS571001R1324		0.110	10
	40	0109883	S401M-UCC40	2CCS571001R1404		0.110	10
	50	0109890	S401M-UCC50	2CCS571001R1504		0.110	10
63	0109906	S401M-UCC63	2CCS571001R1634		0.110	10	
2	0.5	0109913	S402M-UCC0.5	2CCS562001R1984		0.221	5
	1	0109920	S402M-UCC1	2CCS562001R1014		0.221	5
	1.6	0109937	S402M-UCC1.6	2CCS562001R1974		0.221	5
	2	0109944	S402M-UCC2	2CCS562001R1024		0.221	5
	3	0109951	S402M-UCC3	2CCS572001R1034		0.221	5
	4	0109968	S402M-UCC4	2CCS572001R1044		0.221	5
	6	0109975	S402M-UCC6	2CCS572001R1064		0.221	5
	8	0109982	S402M-UCC8	2CCS572001R1084		0.221	5
	10	0109999	S402M-UCC10	2CCS572001R1104		0.221	5
	13	0110001	S402M-UCC13	2CCS572001R1134		0.221	5
	16	0110018	S402M-UCC16	2CCS572001R1164		0.221	5
	20	0110025	S402M-UCC20	2CCS572001R1204		0.221	5
	25	0110032	S402M-UCC25	2CCS572001R1254		0.221	5
	32	0110049	S402M-UCC32	2CCS572001R1324		0.221	5
	40	0110056	S402M-UCC40	2CCS572001R1404		0.221	5
	50	0110063	S402M-UCC50	2CCS572001R1504		0.221	5
63	0110070	S402M-UCC63	2CCS572001R1634		0.221	5	

Connection diagram,
single-pole (max. 220V d.c.)
S401M-UCC

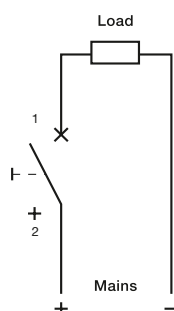

Connection diagram,
two-pole (max. 440V d.c.)
S402M-UCC

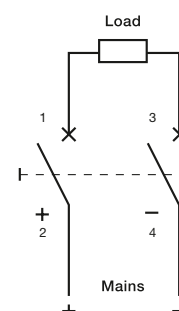

SMISLINE TP plug-in system

MCBs S 400 M-UC series 10000-25000 Z characteristic,
DC application



1 P 220V d.c.



2 P 440V d.c.

S400UC Characteristic Z

Function: protection and control of the electronic circuits against weak and long duration overloads and short-circuits.

Applications: commercial and industrial.

Standard: IEC/EN 60947-2

10 kA (0,5 up to 63 A, 220 V d.c. 1pole), 20 kA (0,5 up to 63 A, 110 V d.c. 1pole)

25 kA (0,5 up to 63 A, 220 V d.c. 2pole), 10 kA (0,5 up to 63 A, 440 V d.c. 2pole)

10 kA (0,5 up to 63 A, 230/400 V) a.c.

Number of poles	Rated current In A	Bbn 761227 EAN	Order details		Price 1 piece	Weight 1 piece kg	Pack unit pc.
			Type code	Order code			
1	0.5	0110087	S401M-UCZ0.5	2CCS561001R1988		0.110	10
	1	0110094	S401M-UCZ1	2CCS561001R1018		0.110	10
	1.6	0110100	S401M-UCZ1.6	2CCS561001R1978		0.110	10
	2	0110117	S401M-UCZ2	2CCS561001R1028		0.110	10
	3	0110124	S401M-UCZ3	2CCS571001R1038		0.110	10
	4	0110131	S401M-UCZ4	2CCS571001R1048		0.110	10
	6	0110148	S401M-UCZ6	2CCS571001R1068		0.110	10
	8	0110155	S401M-UCZ8	2CCS571001R1088		0.110	10
	10	0110162	S401M-UCZ10	2CCS571001R1108		0.110	10
	13	0110179	S401M-UCZ13	2CCS571001R1138		0.110	10
	16	0110186	S401M-UCZ16	2CCS571001R1168		0.110	10
	20	0110193	S401M-UCZ20	2CCS571001R1208		0.110	10
	25	0110209	S401M-UCZ25	2CCS571001R1258		0.110	10
	32	0110216	S401M-UCZ32	2CCS571001R1328		0.110	10
	40	0110223	S401M-UCZ40	2CCS571001R1408		0.110	10
	50	0110230	S401M-UCZ50	2CCS571001R1508		0.110	10
63	0110247	S401M-UCZ63	2CCS571001R1638		0.110	10	
2	0.5	0110254	S402M-UCZ0.5	2CCS562001R1988		0.221	5
	1	0110261	S402M-UCZ1	2CCS562001R1018		0.221	5
	1.6	0110278	S402M-UCZ1.6	2CCS562001R1978		0.221	5
	2	0110285	S402M-UCZ2	2CCS562001R1028		0.221	5
	3	0110292	S402M-UCZ3	2CCS572001R1038		0.221	5
	4	0110308	S402M-UCZ4	2CCS572001R1048		0.221	5
	6	0110315	S402M-UCZ6	2CCS572001R1068		0.221	5
	8	0110322	S402M-UCZ8	2CCS572001R1088		0.221	5
	10	0110339	S402M-UCZ10	2CCS572001R1108		0.221	5
	13	0110346	S402M-UCZ13	2CCS572001R1138		0.221	5
	16	0110353	S402M-UCZ16	2CCS572001R1168		0.221	5
	20	0110360	S402M-UCZ20	2CCS572001R1208		0.221	5
	25	0110377	S402M-UCZ25	2CCS572001R1258		0.221	5
	32	0110384	S402M-UCZ32	2CCS572001R1328		0.221	5
	40	0110391	S402M-UCZ40	2CCS572001R1408		0.221	5
	50	0110407	S402M-UCZ50	2CCS572001R1508		0.221	5
63	0110414	S402M-UCZ63	2CCS572001R1638		0.221	5	

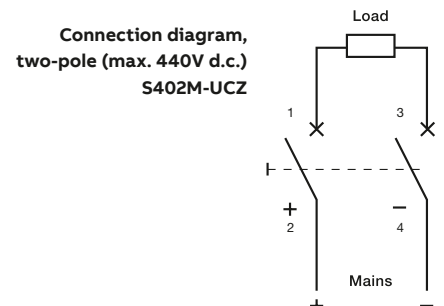
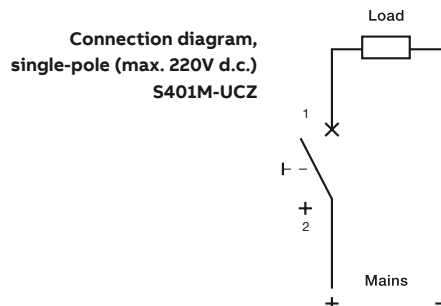

SMISLINE TP plug-in system

Miniature circuit breaker (MCB) S400 M-UC, DC application, $I_{cu} = 10 \dots 25 \text{ kA}$

Z according to IEC/EN 60947-2

Number of poles	Rated current In A	Bbn 761227 EAN	Order details		Price 1 piece	Weight 1 piece kg	Pack unit pc.
			Type code	Order code			
1	0.5	011 0087	S401M-UCZ0.5	2CCS561001R1988		0.110	10
	1	011 0094	S401M-UCZ1	2CCS561001R1018		0.110	10
	1.6	011 0100	S401M-UCZ1.6	2CCS561001R1978		0.110	10
	2	011 0117	S401M-UCZ2	2CCS561001R1028		0.110	10
	3	011 0124	S401M-UCZ3	2CCS571001R1038		0.110	10
	4	011 0131	S401M-UCZ4	2CCS571001R1048		0.110	10
	6	011 0148	S401M-UCZ6	2CCS571001R1068		0.110	10
	8	011 0155	S401M-UCZ8	2CCS571001R1088		0.110	10
	10	011 0162	S401M-UCZ10	2CCS571001R1108		0.110	10
	13	011 0179	S401M-UCZ13	2CCS571001R1138		0.110	10
	16	011 0186	S401M-UCZ16	2CCS571001R1168		0.110	10
	20	011 0193	S401M-UCZ20	2CCS571001R1208		0.110	10
	25	011 0209	S401M-UCZ25	2CCS571001R1258		0.110	10
	32	011 0216	S401M-UCZ32	2CCS571001R1328		0.110	10
	40	011 0223	S401M-UCZ40	2CCS571001R1408		0.110	10
50	011 0230	S401M-UCZ50	2CCS571001R1508		0.110	10	
63	011 0247	S401M-UCZ63	2CCS571001R1638		0.110	10	
2	0.5	011 0254	S402M-UCZ0.5	2CCS562001R1988		0.221	5
	1	011 0261	S402M-UCZ1	2CCS562001R1018		0.221	5
	1.6	011 0278	S402M-UCZ1.6	2CCS562001R1978		0.221	5
	2	011 0285	S402M-UCZ2	2CCS562001R1028		0.221	5
	3	011 0292	S402M-UCZ3	2CCS572001R1038		0.221	5
	4	011 0308	S402M-UCZ4	2CCS572001R1048		0.221	5
	6	011 0315	S402M-UCZ6	2CCS572001R1068		0.221	5
	8	011 0322	S402M-UCZ8	2CCS572001R1088		0.221	5
	10	011 0339	S402M-UCZ10	2CCS572001R1108		0.221	5
	13	011 0346	S402M-UCZ13	2CCS572001R1138		0.221	5
	16	011 0353	S402M-UCZ16	2CCS572001R1168		0.221	5
	20	011 0360	S402M-UCZ20	2CCS572001R1208		0.221	5
	25	011 0377	S402M-UCZ25	2CCS572001R1258		0.221	5
	32	011 0384	S402M-UCZ32	2CCS572001R1328		0.221	5
	40	011 0391	S402M-UCZ40	2CCS572001R1408		0.221	5
50	011 0407	S402M-UCZ50	2CCS572001R1508		0.221	5	
63	011 0414	S402M-UCZ63	2CCS572001R1638		0.221	5	



1 P 220V=



2 P 440V=



Connection diagram,
single-pole (max. 220V=) S401M-UCZ

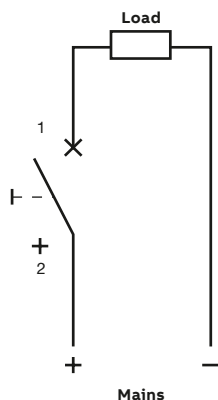

Connection diagram,
two-pole (max. 440V=) S402M-UCZ

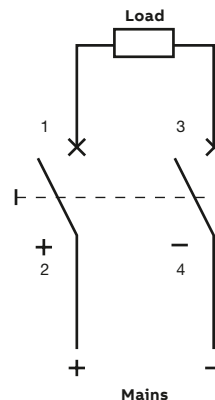

SMISLINE TP plug-in system

Miniature circuit breaker (MCB) for IEC
S400P technical features

Standards

IEC/EN 606947-2 x

General data

Tripping characteristics	B, C, K	
Poles	1P, 1P+NP, 2P, 3P, 3P+NP	
Rated current I_n	2, 3, 4, 6, 8, 10, 13, 16, 20, 25, 32, 40, 50, 63 A	
Calibration temperature	B,C 30°C; K 40°C	
Rated frequency	50/60Hz	
Rated insulation voltage U_i AC 240/415V	440V	
Rated insulation voltage U_i AC 277/480 V	500V	
Rated impulse withstand voltage U_{imp}	4kV	
Overvoltage category	III	
Pollution degree	AC 240/415V: 3	AC 277/480V: 2

Data acc. to IEC/EN 60947-2

Rated operational voltage U_e	1P, 1P+NP: AC 240V 2P, 3P, 3P+NP: AC 240/415V	1P, 1P+NP: AC 277 V 2P, 3P, 3P+NP: AC 277/480V
Minimum operating voltage	1P 60 V DC; 2P 125 V DC (U_{max})	AC 12 V
Rated ultimate short-circuit capacity I_{cu}	40kA (2 up to 16 A, 240/415 VAC) 30 kA (20 up to 40 A, 240/415 VAC) 20 kA (50 up to 63 A, 240/415 VAC)	20 kA (2 up to 16 A, 277/480 VAC) 15 kA (20 up to 40 A, 277/480 VAC) 5 kA (50 up to 63 A, 277/480 VAC)
Rated service short-circuit capacity I_{cs}	20kA (2 up to 16 A, 240/415 VAC) 15kA 20 up to 40 A, 240/415 VAC) 7.5kA 50 up to 63 A, 240/415 VAC)	10 kA (2 up to 16 A, 277/480 VAC) 5 kA (20 up to 40 A, 277/480 VAC) 2.5 kA (50 up to 63 A, 277/480 VAC)
Reference ambient air temperature for overload tripping	B, C: 30°C, K: 40°C	

Mechanical Data

Contact position indication (green OFF/red ON)	x
L1/L2/L3 position indication	x
N position indication	x
Label holder	x
IP Code	IP20B, IP40 in enclosure with cover
Endurance	Electrical endurance: 10000 ops Mechanical endurance: 10000 ops
Shock resistance acc. to IEC/EN 61373	5 g / 30 ms, 3 shocks
Vibration resistance acc. to IEC/EN 60068-2-6	2...13.2 Hz/1 mm 13.2...100 Hz/0.7 g, 5 cycles 5...150...5 Hz/1 g, 4 sweeps
Environmental conditions (damp heat) acc. to IEC/EN 60068-2-30	28 cycles with 55°C/90...96% and 25°C/95...100%
Ambient temperature	-25...+60°C
Storage temperature	-40...+70°C



Installation

Top terminal type	Failsafe bi-directional cylinder-lift terminal with double slot 35/10 mm ²
Top terminal rigid IEC connections (solid/stranded)	Single: 0.75 ÷ 35 mm ² (front slot), 0.75 ÷ 6 mm ² (rear slot) Multiple: 2x 0.75 ÷ 10mm ² (front slot), 2x 0.75 ÷ 6 mm ² (rear slot), with cables of same type and size
Top terminal flexible IEC connections	Single: 0.75 ÷ 25 mm ² (front side), 0.75 ÷ 6 mm ² (rear slot) Multiple: 2x 0.75 ÷ 10mm ² (front slot), 2x 0.75 ÷ 6 mm ² (rear slot), with cables of same type and size
Top terminal screwdriver	No. 2 Pozidrive
Top terminal stripping length	12.5 mm
Top terminal tightening torque	2.8 Nm
Bottom terminal type	Movable plug-on terminal L1/L2/L3, fixed plug-on terminal N
Mounting	SMISLINE TP socket system only
Mounting position	Any
Supply	Any

SMISLINE TP plug-in system

Miniature circuit breaker (MCB) S400P-B, $I_{cu} = 40 \dots 20 \text{ kA}$

B according to IEC/EN 60947-2



	I_{cu}	I_n	Bbn 761227	Order details		Module	Weight 1 piece	Pack unit
	[kA]	[A]	EAN	Type code	Order code			
 <p>S401P</p> <p>1 2</p>	40	2	508418	S401P-B2	2CCG000364R0001	1	0.115	10
	40	3	508425	S401P-B3	2CCG000475R0001	1	0.115	10
	40	4	508432	S401P-B4	2CCG000497R0001	1	0.115	10
	40	6	508449	S401P-B6	2CCG000508R0001	1	0.115	10
	40	8	508456	S401P-B8	2CCG000519R0001	1	0.115	10
	40	10	508463	S401P-B10	2CCG000530R0001	1	0.115	10
	40	13	508470	S401P-B13	2CCG000541R0001	1	0.115	10
	40	16	508487	S401P-B16	2CCG000552R0001	1	0.115	10
	30	20	508494	S401P-B20	2CCG000563R0001	1	0.115	10
	30	25	508500	S401P-B25	2CCG000365R0001	1	0.115	10
	30	32	508517	S401P-B32	2CCG000376R0001	1	0.115	10
	30	40	508524	S401P-B40	2CCG000387R0001	1	0.115	10
	20	50	508531	S401P-B50	2CCG000398R0001	1	0.115	10
20	63	508548	S401P-B63	2CCG000409R0001	1	0.115	10	
 <p>S402P</p> <p>1 3 2 4</p>	40	2	508692	S402P-B2	2CCG000496R0001	2	0.230	5
	40	3	508708	S402P-B3	2CCG000498R0001	2	0.230	5
	40	4	508715	S402P-B4	2CCG000499R0001	2	0.230	5
	40	6	508722	S402P-B6	2CCG000500R0001	2	0.230	5
	40	8	508739	S402P-B8	2CCG000501R0001	2	0.230	5
	40	10	508746	S402P-B10	2CCG000502R0001	2	0.230	5
	40	13	508753	S402P-B13	2CCG000503R0001	2	0.230	5
	40	16	508760	S402P-B16	2CCG000504R0001	2	0.230	5
	30	20	508777	S402P-B20	2CCG000505R0001	2	0.230	5
	30	25	508784	S402P-B25	2CCG000506R0001	2	0.230	5
	30	32	508791	S402P-B32	2CCG000507R0001	2	0.230	5
	30	40	508807	S402P-B40	2CCG000509R0001	2	0.230	5
	20	50	508814	S402P-B50	2CCG000510R0001	2	0.230	5
20	63	508821	S402P-B63	2CCG000511R0001	2	0.230	5	
 <p>S403P</p> <p>1 3 5 2 4 6</p>	40	2	508838	S403P-B2	2CCG000512R0001	3	0.345	3
	40	3	508845	S403P-B3	2CCG000513R0001	3	0.345	3
	40	4	508852	S403P-B4	2CCG000514R0001	3	0.345	3
	40	6	508869	S403P-B6	2CCG000515R0001	3	0.345	3
	40	8	508876	S403P-B8	2CCG000516R0001	3	0.345	3
	40	10	508883	S403P-B10	2CCG000517R0001	3	0.345	3
	40	13	508890	S403P-B13	2CCG000518R0001	3	0.345	3
	40	16	508906	S403P-B16	2CCG000520R0001	3	0.345	3
	30	20	508913	S403P-B20	2CCG000521R0001	3	0.345	3
	30	25	508920	S403P-B25	2CCG000522R0001	3	0.345	3
	30	32	508937	S403P-B32	2CCG000523R0001	3	0.345	3
	30	40	508944	S403P-B40	2CCG000524R0001	3	0.345	3
	20	50	508951	S403P-B50	2CCG000525R0001	3	0.345	3
20	63	508968	S403P-B63	2CCG000526R0001	3	0.345	3	

Ordering details for auxiliary switch and signal contacts on page 49–50

SMISLINE TP plug-in system

Miniature circuit breaker (MCB) S400P-C, $I_{cu} = 40 \dots 20 \text{ kA}$

C according to IEC/EN 60947-2



	I_{cu}	I_n	Bbn 761227	Order details		Module	Weight 1 piece	Pack unit
	[kA]	[A]	EAN	Type code	Order code			
 <p>S401P</p> <p>1 2</p>	40	2	509118	S401P-C2	2CCG000543R0001	1	0.115	10
	40	3	509125	S401P-C3	2CCG000544R0001	1	0.115	10
	40	4	509132	S401P-C4	2CCG000545R0001	1	0.115	10
	40	6	509149	S401P-C6	2CCG000546R0001	1	0.115	10
	40	8	509156	S401P-C8	2CCG000547R0001	1	0.115	10
	40	10	509163	S401P-C10	2CCG000548R0001	1	0.115	10
	40	13	509170	S401P-C13	2CCG000549R0001	1	0.115	10
	40	16	509187	S401P-C16	2CCG000550R0001	1	0.115	10
	30	20	509194	S401P-C20	2CCG000551R0001	1	0.115	10
	30	25	509200	S401P-C25	2CCG000553R0001	1	0.115	10
	30	32	509217	S401P-C32	2CCG000554R0001	1	0.115	10
	30	40	509224	S401P-C40	2CCG000555R0001	1	0.115	10
	20	50	509231	S401P-C50	2CCG000556R0001	1	0.115	10
	20	63	509248	S401P-C63	2CCG000557R0001	1	0.115	10
 <p>S402P</p> <p>1 3 2 4</p>	40	2	509392	S402P-C2	2CCG000573R0001	2	0.230	5
	40	3	509408	S402P-C3	2CCG000366R0001	2	0.230	5
	40	4	509415	S402P-C4	2CCG000367R0001	2	0.230	5
	40	6	509422	S402P-C6	2CCG000368R0001	2	0.230	5
	40	8	509439	S402P-C8	2CCG000369R0001	2	0.230	5
	40	10	509446	S402P-C10	2CCG000370R0001	2	0.230	5
	40	13	509453	S402P-C13	2CCG000371R0001	2	0.230	5
	40	16	509460	S402P-C16	2CCG000372R0001	2	0.230	5
	30	20	509477	S402P-C20	2CCG000373R0001	2	0.230	5
	30	25	509484	S402P-C25	2CCG000374R0001	2	0.230	5
	30	32	509491	S402P-C32	2CCG000375R0001	2	0.230	5
	30	40	509507	S402P-C40	2CCG000377R0001	2	0.230	5
	20	50	509514	S402P-C50	2CCG000378R0001	2	0.230	5
	20	63	509521	S402P-C63	2CCG000379R0001	2	0.230	5
 <p>S403P</p> <p>1 3 5 2 4 6</p>	40	2	509538	S403P-C2	2CCG000380R0001	3	0.345	3
	40	3	509545	S403P-C3	2CCG000381R0001	3	0.345	3
	40	4	509552	S403P-C4	2CCG000382R0001	3	0.345	3
	40	6	509569	S403P-C6	2CCG000383R0001	3	0.345	3
	40	8	509576	S403P-C8	2CCG000384R0001	3	0.345	3
	40	10	509583	S403P-C10	2CCG000385R0001	3	0.345	3
	40	13	509590	S403P-C13	2CCG000386R0001	3	0.345	3
	40	16	509606	S403P-C16	2CCG000388R0001	3	0.345	3
	30	20	509613	S403P-C20	2CCG000389R0001	3	0.345	3
	30	25	509620	S403P-C25	2CCG000390R0001	3	0.345	3
	30	32	509637	S403P-C32	2CCG000391R0001	3	0.345	3
	30	40	509644	S403P-C40	2CCG000392R0001	3	0.345	3
	20	50	509651	S403P-C50	2CCG000393R0001	3	0.345	3
	20	63	509668	S403P-C63	2CCG000394R0001	3	0.345	3

Ordering details for auxiliary switch and signal contacts on page 49–50

SMISLINE TP plug-in system

Miniature circuit breaker (MCB) S400P-K, $I_{cu} = 40 \dots 20 \text{ kA}$

K according to IEC/EN 60947-2





	I_{cu}	I_n	Bbn 761227	Order details		Module	Weight 1 piece	Pack unit
	[kA]	[A]	EAN	Type code	Order code			
 <p>S401P</p> <p>1 2</p>	40	2	509811	S401P-K2	2CCG000411R0001	1	0.115	10
	40	3	509828	S401P-K3	2CCG000412R0001	1	0.115	10
	40	4	509835	S401P-K4	2CCG000413R0001	1	0.115	10
	40	6	509842	S401P-K6	2CCG000414R0001	1	0.115	10
	40	8	509859	S401P-K8	2CCG000415R0001	1	0.115	10
	40	10	509866	S401P-K10	2CCG000416R0001	1	0.115	10
	40	13	509873	S401P-K13	2CCG000417R0001	1	0.115	10
	40	16	509880	S401P-K16	2CCG000418R0001	1	0.115	10
	30	20	509897	S401P-K20	2CCG000419R0001	1	0.115	10
	30	25	509903	S401P-K25	2CCG000421R0001	1	0.115	10
	30	32	509910	S401P-K32	2CCG000422R0001	1	0.115	10
	30	40	509927	S401P-K40	2CCG000423R0001	1	0.115	10
	20	50	509934	S401P-K50	2CCG000424R0001	1	0.115	10
	20	63	509941	S401P-K63	2CCG000425R0001	1	0.115	10
 <p>S402P</p> <p>1 3 2 4</p>	40	2	510091	S402P-K2	2CCG000441R0001	2	0.230	5
	40	3	510107	S402P-K3	2CCG000443R0001	2	0.230	5
	40	4	510114	S402P-K4	2CCG000444R0001	2	0.230	5
	40	6	510121	S402P-K6	2CCG000445R0001	2	0.230	5
	40	8	510138	S402P-K8	2CCG000446R0001	2	0.230	5
	40	10	510145	S402P-K10	2CCG000447R0001	2	0.230	5
	40	13	510152	S402P-K13	2CCG000448R0001	2	0.230	5
	40	16	510169	S402P-K16	2CCG000449R0001	2	0.230	5
	30	20	510176	S402P-K20	2CCG000450R0001	2	0.230	5
	30	25	510183	S402P-K25	2CCG000451R0001	2	0.230	5
	30	32	510190	S402P-K32	2CCG000452R0001	2	0.230	5
	30	40	510206	S402P-K40	2CCG000454R0001	2	0.230	5
	20	50	510213	S402P-K50	2CCG000455R0001	2	0.230	5
	20	63	510220	S402P-K63	2CCG000456R0001	2	0.230	5
 <p>S403P</p> <p>1 3 5 2 4 6</p>	40	2	510237	S403P-K2	2CCG000457R0001	3	0.345	3
	40	3	510244	S403P-K3	2CCG000458R0001	3	0.345	3
	40	4	510251	S403P-K4	2CCG000459R0001	3	0.345	3
	40	6	510268	S403P-K6	2CCG000460R0001	3	0.345	3
	40	8	510275	S403P-K8	2CCG000461R0001	3	0.345	3
	40	10	510282	S403P-K10	2CCG000462R0001	3	0.345	3
	40	13	510299	S403P-K13	2CCG000463R0001	3	0.345	3
	40	16	510305	S403P-K16	2CCG000465R0001	3	0.345	3
	30	20	510312	S403P-K20	2CCG000466R0001	3	0.345	3
	30	25	510329	S403P-K25	2CCG000467R0001	3	0.345	3
	30	32	510336	S403P-K32	2CCG000468R0001	3	0.345	3
	30	40	510343	S403P-K40	2CCG000469R0001	3	0.345	3
	20	50	510350	S403P-K50	2CCG000470R0001	3	0.345	3
	20	63	510367	S403P-K63	2CCG000471R0001	3	0.345	3

Ordering details for auxiliary switch and signal contacts on page 49–50

SMISLINE TP plug-in system

Miniature circuit breaker (MCB) S400P-K with protected neutral $I_{cu} = 20 \dots 40 \text{ kA}$

K according to IEC/EN 60947-2





	I_{cu}	I_n	Bbn 761227	Order details		Module	Weight 1 piece	Pack unit
	[kA]	[A]	EAN	Type code	Order code			
 <p>S402P</p> 	40	2	508555	S401P-B2NP	2CCG000420R0001	2	0.230	5
	40	3	508562	S401P-B3NP	2CCG000431R0001	2	0.230	5
	40	4	508579	S401P-B4NP	2CCG000442R0001	2	0.230	5
	40	6	508586	S401P-B6NP	2CCG000453R0001	2	0.230	5
	40	8	508593	S401P-B8NP	2CCG000464R0001	2	0.230	5
	40	10	508609	S401P-B10NP	2CCG000476R0001	2	0.230	5
	40	13	508616	S401P-B13NP	2CCG000487R0001	2	0.230	5
	40	16	508623	S401P-B16NP	2CCG000489R0001	2	0.230	5
	30	20	508630	S401P-B20NP	2CCG000490R0001	2	0.230	5
	30	25	508647	S401P-B25NP	2CCG000491R0001	2	0.230	5
	30	32	508654	S401P-B32NP	2CCG000492R0001	2	0.230	5
	30	40	508661	S401P-B40NP	2CCG000493R0001	2	0.230	5
	20	50	508678	S401P-B50NP	2CCG000494R0001	2	0.230	5
	20	63	508685	S401P-B63NP	2CCG000495R0001	2	0.230	5
 <p>S404P</p> 	40	2	508975	S403P-B2NP	2CCG000527R0001	4	0.460	2
	40	3	508982	S403P-B3NP	2CCG000528R0001	4	0.460	2
	40	4	508999	S403P-B4NP	2CCG000529R0001	4	0.460	2
	40	6	509002	S403P-B6NP	2CCG000531R0001	4	0.460	2
	40	8	509019	S403P-B8NP	2CCG000532R0001	4	0.460	2
	40	10	509026	S403P-B10NP	2CCG000533R0001	4	0.460	2
	40	13	509033	S403P-B13NP	2CCG000534R0001	4	0.460	2
	40	16	509040	S403P-B16NP	2CCG000535R0001	4	0.460	2
	30	20	509057	S403P-B20NP	2CCG000536R0001	4	0.460	2
	30	25	509064	S403P-B25NP	2CCG000537R0001	4	0.460	2
	30	32	509071	S403P-B32NP	2CCG000538R0001	4	0.460	2
	30	40	509088	S403P-B40NP	2CCG000539R0001	4	0.460	2
	20	50	509095	S403P-B50NP	2CCG000540R0001	4	0.460	2
	20	63	509101	S403P-B63NP	2CCG000542R0001	4	0.460	2

Ordering details for auxiliary switch and signal contacts on page 49–50

SMISLINE TP plug-in system

Miniature circuit breaker (MCB) S400P-C with protected neutral $I_{cu} = 20 \dots 40 \text{ kA}$

C according to IEC/EN 60947-2





	I_{cu}	I_n	Bbn 761227	Order details		Module	Weight 1 piece	Pack unit
	[kA]	[A]	EAN	Type code	Order code			
 <p>S402P</p> 	40	2	509255	S401P-C2NP	2CCG000558R0001	2	0.230	5
	40	3	509262	S401P-C3NP	2CCG000559R0001	2	0.230	5
	40	4	509279	S401P-C4NP	2CCG000560R0001	2	0.230	5
	40	6	509286	S401P-C6NP	2CCG000561R0001	2	0.230	5
	40	8	509293	S401P-C8NP	2CCG000562R0001	2	0.230	5
	40	10	509309	S401P-C10NP	2CCG000564R0001	2	0.230	5
	40	13	509316	S401P-C13NP	2CCG000565R0001	2	0.230	5
	40	16	509323	S401P-C16NP	2CCG000566R0001	2	0.230	5
	30	20	509330	S401P-C20NP	2CCG000567R0001	2	0.230	5
	30	25	509347	S401P-C25NP	2CCG000568R0001	2	0.230	5
	30	32	509354	S401P-C32NP	2CCG000569R0001	2	0.230	5
	30	40	509361	S401P-C40NP	2CCG000570R0001	2	0.230	5
	20	50	509378	S401P-C50NP	2CCG000571R0001	2	0.230	5
	20	63	509385	S401P-C63NP	2CCG000572R0001	2	0.230	5
 <p>S404P</p> 	40	2	509675	S403P-C2NP	2CCG000395R0001	4	0.460	2
	40	3	509682	S403P-C3NP	2CCG000396R0001	4	0.460	2
	40	4	509699	S403P-C4NP	2CCG000397R0001	4	0.460	2
	40	6	509705	S403P-C6NP	2CCG000399R0001	4	0.460	2
	40	8	509712	S403P-C8NP	2CCG000400R0001	4	0.460	2
	40	10	509729	S403P-C10NP	2CCG000401R0001	4	0.460	2
	40	13	509736	S403P-C13NP	2CCG000402R0001	4	0.460	2
	40	16	509743	S403P-C16NP	2CCG000403R0001	4	0.460	2
	30	20	509750	S403P-C20NP	2CCG000404R0001	4	0.460	2
	30	25	509767	S403P-C25NP	2CCG000405R0001	4	0.460	2
	30	32	509774	S403P-C32NP	2CCG000406R0001	4	0.460	2
	30	40	509781	S403P-C40NP	2CCG000407R0001	4	0.460	2
	20	50	509798	S403P-C50NP	2CCG000408R0001	4	0.460	2
	20	63	509804	S403P-C63NP	2CCG000410R0001	4	0.460	2

Ordering details for auxiliary switch and signal contacts on page 49–50

SMISLINE TP plug-in system

Miniature circuit breaker (MCB) S400P-K with protected neutral $I_{cu} = 20 \dots 40 \text{ kA}$

K according to IEC/EN 60947-2

	I_{cu}	I_n	Bbn 761227	Order details		Module	Weight 1 piece	Pack unit
	[kA]	[A]	EAN	Type code	Order code			
 <p>S402P</p> 	40	2	509958	S401P-K2NP	2CCG000426R0001	2	0.230	5
	40	3	509965	S401P-K3NP	2CCG000427R0001	2	0.230	5
	40	4	509972	S401P-K4NP	2CCG000428R0001	2	0.230	5
	40	6	509989	S401P-K6NP	2CCG000429R0001	2	0.230	5
	40	8	509996	S401P-K8NP	2CCG000430R0001	2	0.230	5
	40	10	510008	S401P-K10NP	2CCG000432R0001	2	0.230	5
	40	13	510015	S401P-K13NP	2CCG000433R0001	2	0.230	5
	40	16	510022	S401P-K16NP	2CCG000434R0001	2	0.230	5
	30	20	510039	S401P-K20NP	2CCG000435R0001	2	0.230	5
	30	25	510046	S401P-K25NP	2CCG000436R0001	2	0.230	5
	30	32	510053	S401P-K32NP	2CCG000437R0001	2	0.230	5
	30	40	510060	S401P-K40NP	2CCG000438R0001	2	0.230	5
	20	50	510077	S401P-K50NP	2CCG000439R0001	2	0.230	5
	20	63	510084	S401P-K63NP	2CCG000440R0001	2	0.230	5
 <p>S404P</p> 	40	2	510374	S403P-K2NP	2CCG000472R0001	4	0.460	2
	40	3	510381	S403P-K3NP	2CCG000473R0001	4	0.460	2
	40	4	510398	S403P-K4NP	2CCG000474R0001	4	0.460	2
	40	6	510404	S403P-K6NP	2CCG000477R0001	4	0.460	2
	40	8	510411	S403P-K8NP	2CCG000478R0001	4	0.460	2
	40	10	510428	S403P-K10NP	2CCG000479R0001	4	0.460	2
	40	13	510435	S403P-K13NP	2CCG000480R0001	4	0.460	2
	40	16	510442	S403P-K16NP	2CCG000481R0001	4	0.460	2
	30	20	510459	S403P-K20NP	2CCG000482R0001	4	0.460	2
	30	25	510466	S403P-K25NP	2CCG000483R0001	4	0.460	2
	30	32	510473	S403P-K32NP	2CCG000484R0001	4	0.460	2
	30	40	510480	S403P-K40NP	2CCG000485R0001	4	0.460	2
	20	50	510497	S403P-K50NP	2CCG000486R0001	4	0.460	2
	20	63	510503	S403P-K63NP	2CCG000488R0001	4	0.460	2

Ordering details for auxiliary switch and signal contacts on page 49–50

SMISSLINE TP plug-in system

Miniature circuit breaker (MCB) for UL489 277/480 V AC SUP400 technical features

Technical Data

General Data	
Standards	UL 489, CSA 22.2 No. 5, IEC/EN 60947-2
Rated voltage	277/480 V AC
Poles	1P, 2P, 3P
Tripping characteristics	K
Rated current I_n	2 to 35A
Rated frequency f	50/60 Hz
Short circuit current rating (acc. to UL 489)	10 kA
Overvoltage category	III
Pollution degree	2
Calibration temperature	40 °C
Mechanical Data	
Housing	RAL 7035
Toggle	Black sealable
Contact position indication	Real CPI (green OFF / red ON)
L1/L2/L3 position indication	Yes
Protection degree acc. to EN 60529	IP20*, IP40 in enclosure with cover
Label holder	Yes
Mechanical endurance	10,000 ops.
Shock resistance acc. to IEC/EN 61373	5 g/30 ms, 3 shocks
Vibration resistance acc. to IEC/EN 60068-2-6	2 ... 13.2 Hz/1 mm 13.2 ... 100 Hz/0.7 g, 5 cycles 5 ... 150 ... 5 Hz/1 g, 4 sweeps
Environmental conditions (damp heat) acc. to IEC/EN 60068-2-30	28 cycles with 55 °C/90 ... 96 % and 25 °C/95 ... 100 %
Ambient temperature	-13 °F ... +131 °F; -25 ... +55 °C
Storage temperature	-40 °F ... +158 °F; -40 ... +70 °C
Installation	
Terminal type F	Failsafe bi-directional cylinder-lift terminal (shock protected)
Terminal rigid IEC connections (solid/stranded)	Single wire only, rigid IEC connections (solid/stranded): 0.75...35 mm ² (front slot), 0.75...10 mm ² (rear slot) Single wire only, flexible IEC connections: 0.75...25 mm ² (front side), 0.75...6 mm ² (rear slot)
Terminal UL connections	Single wire only: AWG 14...8, Cu only AWG 14-8 single conductor CU only
Torque	2.8 Nm, 25 in. lbs.
Stripping length	12.5 mm
Wire temperature	60/75 °C
Screwdriver	No. 2 Pozidrive
Terminal at line side	Movable plug-on terminal L1, L2, L3
Mounting	SMISSLINE TP socket system only
Mounting position	Any
Dimensions and weight	
Pole weight	120 g

* Also fulfilling the requirement acc. to protection degree IPXXB

The devices are suitable with
 – S2C-H6RU (auxiliary contact)
 – S2C-S6RU (signal/auxiliary contact)
 – E210-DH (false pole 1/2 module)
 – SA (locking device)

SMISLINE TP plug-in system

Miniature circuit breaker SUP400 for branch circuit protection acc. to UL489

File E312425



Ordering Data

Number of poles	Rated current I _n	Bbn 761227	Order details		Price 1 piece	Weight 1 piece	Pack unit
			A	EAN			
1	2	1506759	SUP401M-K2	2CCG000142R0001		0.120	10
	3	1506766	SUP401M-K3	2CCG000143R0001		0.120	10
	4	1506773	SUP401M-K4	2CCG000144R0001		0.120	10
	5	1506865	SUP401M-K5	2CCG000153R0001		0.120	10
	6	1506780	SUP401M-K6	2CCG000145R0001		0.120	10
	8	1506797	SUP401M-K8	2CCG000146R0001		0.120	10
	10	1506803	SUP401M-K10	2CCG000147R0001		0.120	10
	13	1506810	SUP401M-K13	2CCG000148R0001		0.120	10
	15	1506872	SUP401M-K15	2CCG000154R0001		0.120	10
	16	1506827	SUP401M-K16	2CCG000149R0001		0.120	10
	20	1506834	SUP401M-K20	2CCG000150R0001		0.120	10
	25	1506841	SUP401M-K25	2CCG000151R0001		0.120	10
	30	1506858	SUP401M-K30	2CCG000152R0001		0.120	10
	35	1516109	SUP401M-K35	2CCG001141R0001		0.120	10

Ordering Data

Number of poles	Rated current I _n	Bbn 761227	Order details		Price 1 piece	Weight 1 piece	Pack unit
			A	EAN			
2	2	1506384	SUP402M-K2	2CCG000106R0001		0.240	5
	3	1506391	SUP402M-K3	2CCG000107R0001		0.240	5
	4	1506506	SUP402M-K4	2CCG000108R0001		0.240	5
	5	1506599	SUP402M-K5	2CCG000117R0001		0.240	5
	6	1506513	SUP402M-K6	2CCG000109R0001		0.240	5
	8	1506520	SUP402M-K8	2CCG000110R0001		0.240	5
	10	1506537	SUP402M-K10	2CCG000111R0001		0.240	5
	13	1506544	SUP402M-K13	2CCG000112R0001		0.240	5
	15	1506605	SUP402M-K15	2CCG000118R0001		0.240	5
	16	1506551	SUP402M-K16	2CCG000113R0001		0.240	5
	20	1506568	SUP402M-K20	2CCG000114R0001		0.240	5
	25	1506575	SUP402M-K25	2CCG000115R0001		0.240	5
	30	1506582	SUP402M-K30	2CCG000116R0001		0.240	5
	35	1516116	SUP402M-K35	2CCG001142R0001		0.240	5
	3	2	1506612	SUP403M-K2	2CCG000119R0001		0.360
3		1506629	SUP403M-K3	2CCG000120R0001		0.360	3
4		1506636	SUP403M-K4	2CCG000121R0001		0.360	3
5		1506728	SUP403M-K5	2CCG000130R0001		0.360	3
6		1506643	SUP403M-K6	2CCG000122R0001		0.360	3
8		1506650	SUP403M-K8	2CCG000123R0001		0.360	3
10		1506667	SUP403M-K10	2CCG000124R0001		0.360	3
13		1506674	SUP403M-K13	2CCG000125R0001		0.360	3
15		1506735	SUP403M-K15	2CCG000131R0001		0.360	3
16		1506681	SUP403M-K16	2CCG000126R0001		0.360	3
20		1506698	SUP403M-K20	2CCG000127R0001		0.360	3
25		1506704	SUP403M-K25	2CCG000128R0001		0.360	3
30		1506711	SUP403M-K30	2CCG000129R0001		0.360	3
35		1516123	SUP403M-K35	2CCG001143R0001		0.360	3



Residual current operated circuit breaker

Typ A 

Bi-directional cylindrical terminal ensure higher safety of connecting operations, making them easier.

Test pushbutton to verify the correct functioning of the device.

Contact position indicator (CPI): to always know the status of the contacts (red: closed contacts; green: open contacts) independently on the toggle position.



Information on the device are laser printed to make them clearly visible and long lasting.

Plug contacts can be moved easily between L1, L2 and L3. Capacities, e.g. of battery systems, can be fully utilized. A different arrangement can be set up quickly and easily. Inspection glass with phase indicator on the front of the device.

Residual current operated circuit breaker RCCBs

F402 technical features, A type and APR-F (K type)

	F402	F402 APR
Standards	IEC/EN 61008-1 IEC/EN 61008-2-1	IEC/EN 61008-1 IEC/EN 61008-2-1 IEC/EN 62423
Electrical features		
Type (wave form of the earth leakage sensed)	A	APR - F
Number of poles	1P + N	1P + N
Rated current I_n	25, 40A	40A
Rated sensitivity $I_{\Delta n}$	0.01, 0.03, 0.1 A	0.03A
Rated voltage U_e	230V	230/400V
Rated insulation voltage (U_i)	500V	500V
Overtoltage category	III	III
Pollution degree	2	2
Operating voltage of circuit test	110V (170 for 30 mA) – 254V	170 – 254V
Rated frequency	50/60Hz	50/60Hz
Rated conditional short-circuit current I_{nc}	10kA with SCPD - fuse gG 100 A or high performance MCB S800 100 A	
Rated residual breaking capacity $I_{\Delta m}$	1 kA	
Surge current resistance (wave 8/20)	N/A	3000A
Mechanical features		
Housing	Light grey RAL 7035	Light grey RAL 7035
Toggle	Blue RAL 5015, sealable in ON-OFF positions	Blue RAL 5015, sealable in ON-OFF positions
Contact position indication	Green/Red Window	Green/Red Window
Endurance	Electrical endurance: 10000 ops Mechanical endurance: 10000 ops	Electrical endurance: 10000 ops Mechanical endurance: 10000 ops
IP code	IP20, IP40 in enclosure with cover	IP20, IP40 in enclosure with cover
Shock resistance acc. to IEC/EN 61373	5 g – 30ms, 3 shocks	5 g – 30ms, 3 shocks
Vibration resistance acc. to IEC/EN 60068-2-6	2 ... 13.2Hz/1 mm 13.2 ... 100Hz/0.7g, 5 cycles 5 ... 150 ... 5Hz/1g, 4 waves	2 ... 13.2Hz/1 mm 13.2 ... 100Hz/0.7g, 5 cycles 5 ... 150 ... 5Hz/1g, 4 waves
Environmental conditions (damp heat) acc. to IEC/EN 60068-2-30	28 cycles with 55°C/90...96% and 25°C/95...100%	
Ambient temperature	-25...+55°C	-25...+55°C
Storage temperature	-40...+70°C	-40...+70°C
Installation		
Terminal type	failsafe bi-directional cylinder-lift terminal (shock protected)	
Top terminal rigid IEC connections (solid/stranded)	Single: 0.75...25 mm ² (front slot), 0.75...10 mm ² (rear slot) Multiple: 2x0.75...10 mm ² (front slot), 2x0.75...6 mm ² (rear slot), with cables of same type and size	
Top terminal flexible IEC connections	Single: 0.75...16 mm ² (front side), 0.75...6 mm ² (rear slot) Multiple: 2x0.75...10 mm ² (front slot), 2x0.75...6 mm ² (rear slot), with cables of same type and size	

Residual current operated circuit breaker RCCBs

F404 technical features, A type and APR-F (K type)

	F404 A	F404 A-K	F404 S	F404 LF
Standards	IEC/EN 61008-1 IEC/EN 61008-2-1	IEC/EN 61008-1 IEC/EN 61008-2-1 IEC/EN 62423	IEC/EN 61008-1 IEC/EN 61008-2-1	IEC/EN 61008-1 IEC/EN 61008-2-1
Electrical features				
Type (wave form of the earth leakage sensed)	A	APR - F	A	A
Number of poles	3P + N	3P + N	3P + N	3P + N
Rated current I_n	25, 40, 63 A	40, 63 A	63 A	63 A
Rated sensitivity $I_{\Delta n}$	0.03, 0.1, 0.3 A	0.03–0.1 A	0.1, 0.3 A	0.03, 0.3 A
Rated voltage U_e	230/400V	230/400V	230/400V	230/400V
Rated insulation voltage (U_i)	500V	500V	500V	500V
Overvoltage category	III	III	III	III
Pollution degree	2	2	2	2
Operating voltage of circuit test	110V (170 for 30 mA) – 254V	110V (170 for 30 mA) – 254V	110 – 254V	110 (170 for 30 mA) – 254V
Rated frequency Hz	50/60Hz	50/60Hz	50/60Hz	16 ² / ₃ Hz
Rated conditional short-circuit current I_{nc}	10 kA with SCPD – fuse gG	100A or high performance	MCB S800 100A	
Rated residual breaking capacity $I_{\Delta m}$	1 kA	1 kA	1 kA	1 kA
Surge current resistance (wave 8/20)	N/A	3000A	5000A	N/A
Mechanical features				
Housing	Insulation group I, light grey RAL 7035	Insulation group I, light grey RAL 7035	Insulation group I, light grey RAL 7035	Insulation group I, light grey RAL 7035
Toggle	Insulation group II, blue RAL 5015, sealable in ON-OFF positions	Insulation group II, blue RAL 5015, sealable in ON-OFF positions	Insulation group II, blue RAL 5015, sealable in ON-OFF positions	Insulation group II, blue RAL 5015, sealable in ON-OFF positions
Contact position indication	Green/Red Window	Green/Red Window	Green/Red Window	Green/Red Window
Endurance	Electrical endurance: 10000 ops Mechanical endurance: 10000 ops	Electrical endurance: 10000 ops Mechanical endurance: 10000 ops	Electrical endurance: 10000 ops Mechanical endurance: 10000 ops	Electrical endurance: 10000 ops Mechanical endurance: 10000 ops
IP code	IP20, IP40 in enclosure with cover	IP20, IP40 in enclosure with cover	IP20, IP40 in enclosure with cover	IP20, IP40 in enclosure with cover
Shock resistance acc. to IEC/EN 61373	5 g – 30 ms, 3 shocks	5 g – 30 ms, 3 shocks	5 g – 30 ms, 3 shocks	5 g – 30 ms, 3 shocks
Vibration resistance acc. to IEC/EN 60068-2-6	2 ... 13.2 Hz/1 mm, 13.2 ... 100 Hz/0.7 g, 5 cycles, 5 ... 150 ... 5 Hz/1 g, 4 waves	2 ... 13.2 Hz/1 mm, 13.2 ... 100 Hz/0.7 g, 5 cycles, 5 ... 150 ... 5 Hz/1 g, 4 waves	2 ... 13.2 Hz/1 mm, 13.2 ... 100 Hz/0.7 g, 5 cycles, 5 ... 150 ... 5 Hz/1 g, 4 waves	2 ... 13.2 Hz/1 mm, 13.2 ... 100 Hz/0.7 g, 5 cycles, 5 ... 150 ... 5 Hz/1 g, 4 waves
Environmental conditions (damp heat) acc. to IEC/EN 60068-2-30	28 cycles with 55 °C/90 ... 96 % and 25 °C/95 ... 100 %	28 cycles with 55 °C/90 ... 96 % and 25 °C/95 ... 100 %	28 cycles with 55 °C/90 ... 96 % and 25 °C/95 ... 100 %	28 cycles with 55 °C/90 ... 96 % and 25 °C/95 ... 100 %
Ambient temperature	–25 ... +55 °C	–25 ... +55 °C	–25 ... +55 °C	–25 ... +55 °C
Storage temperature	–40 ... +70 °C	–40 ... +70 °C	–40 ... +70 °C	–40 ... +70 °C
Installation				
Terminal type	failsafe bi-directional cylinder-lift terminal (shock protected)			
Top terminal rigid IEC connections (solid/stranded)	Single: 0.75...25 mm ² (front slot), 0.75...10 mm ² (rear slot) Multiple: 2x0.75...10 mm ² (front slot), 2x0.75...6 mm ² (rear slot), with cables of same type and size			
Top terminal flexible IEC connections	Single: 0.75...16 mm ² (front side), 0.75...6 mm ² (rear slot) Multiple: 2x0.75...10 mm ² (front slot), 2x0.75...6 mm ² (rear slot), with cables of same type and size			

Tripping time settings type A

Tripping time

Type	Rated sensitivity	Tripping time			
Alternating current	$1 \times I_{\Delta n}$	$2 \times I_{\Delta n}$	$5 \times I_{\Delta n}$	500 A	
Pulsating current with DC components	$1,4 \times I_{\Delta n}$	$2 \times 1,4 \times I_{\Delta n}$	$5 \times 1,4 \times I_{\Delta n}$	500 A	
Detection of smooth DC currents	$2 \times I_{\Delta n}$	$2 \times 2 \times I_{\Delta n}$	$5 \times 2 \times I_{\Delta n}$	500 A	
Standard or short time		max. 0,3 s	max. 0,15 s	max. 0,04 s	max. 0,04 s

Residual current operated circuit breaker RCCBs

F404 technical features, B type

F404 B	
Standards	IEC/EN 61008-1 IEC/EN 61008-2-1 IEC/EN 62423"
Electrical features	
Type (wave form of the earth leakage sensed)	B
Number of poles	3P + N
Rated current I_n	25, 40, 63 A
Rated sensitivity $I_{\Delta n}$	0.03, 0.3 A
Rated voltage U_e	230/400V
Rated insulation voltage (U_i)	500V
Overvoltage category	III
Pollution degree	2
Operating voltage of circuit test	110V (170 for 30 mA) – 254V
Rated frequency	50/60Hz
Rated conditional short-circuit current I_{nc}	10 kA with SCPD – fuse gG 100A or high performance MCB S800 100 A
Rated residual breaking capacity $I_{\Delta m}$	1 kA
Surge current resistance (wave 8/20)	3000A
Operating voltage of circuit test U_t IEC/EN	110 - 253 V AC 170 - 253 V AC (30 mA)
Maximum electronic consumption	1.2W
Mechanical features	
Housing	Light grey RAL 7035
Toggle	Blue RAL 5015, sealable in ON-OFF positions
Contact position indication	Green/Red Window
Electrical life	10000 operations
Mechanical life	10000 operations
IP code	IP20, IP40 in enclosure with cover
Shock resistance acc. to IEC/EN 61373	5 g – 30 ms, 3 shocks
Vibration resistance acc. to IEC/EN 60068-2-6	2 ... 13.2 Hz/1 mm 13.2 ... 100 Hz/0.7 g, 5 cycles 5 ... 150 ... 5 Hz/1 g, 4 waves
Environmental conditions (damp heat) acc. to IEC/EN 60068-2-30	28 cycles with 55 °C/90...96% and 25 °C/95...100%
Ambient temperature	-25...+70 for system current ≤ 32 A -25...+65 for system current = 40 A -25...+50 for system current = 63 A
Storage temperature	-40 ... +70 °C
Installation	
Terminal type	failsafe bi-directional cylinder-lift terminal (shock protected)
Top terminal rigid IEC connections (solid/stranded)	Single: 0.75...25 mm ² (front slot), 0.75...10 mm ² (rear slot) Multiple: 2 x 0.75...10 mm ² (front slot), 2 x 0.75...6 mm ² (rear slot), with cables of same type and size
Top terminal flexible IEC connections	Single: 0.75...16 mm ² (front side), 0.75...6 mm ² (rear slot) Multiple: 2 x 0.75...10 mm ² (front slot), 2 x 0.75...6 mm ² (rear slot), with cables of same type and size

SMISLINE TP plug-in system

RCCBs F400 series, A  type



F402



F404

F402 A type

Function: protection against the effects of sinusoidal alternating and direct pulsating earth fault currents; protection against indirect contacts and additional protection against direct (with $I_{\Delta n} = 30 \text{ mA}$) contacts.

Application: residential, commercial, industrial.

Standard: IEC/EN 61008

Marking: according to EN 61008

Number of poles	Rated residual current $I_{\Delta n} \text{ mA}$	Rated current $I_n \text{ A}$	Bbn 801254 EAN	Order details		Price 1 piece	Weight 1 piece kg	Pack unit pc.
				Type code	Order code			
2	10	25	2037033	F402 A 25/0.01	2CSF502110R0250	0.250	1	
	30	25	2034339	F402 A 25/0.03	2CSF502110R1250			
	30	40	2036937	F402 A 40/0.03	2CSF502110R1400			
	100	40	2034230	F402 A 40/0.1	2CSF502110R2400			

F404 A type

Function: protection against the effects of sinusoidal alternating and direct pulsating earth fault currents; protection against indirect contacts and additional protection against direct (with $I_{\Delta n} = 30 \text{ mA}$) contacts. Product helpful where for installation habits, for wiring with busbars or cables, for special needs neutral on the left is needed.

Application: residential, commercial, industrial.

Standard: IEC/EN 61008

Marking: according to EN 61008

Number of poles	Rated residual current $I_{\Delta n} \text{ mA}$	Rated current $I_n \text{ A}$	Bbn 761227 EAN	Order details		Price 1 piece	Weight 1 piece kg	Pack unit pc.
				Type code	Order code			
2	30	25	0104253	F404 A 25/0.03	2CCF544110E0250	0.430	1	
	30	40	0104260	F404 A 40/0.03	2CCF544110E0400			
	100	40	0104277	F404 A 40/0.1	2CCF544120E0400			
	300	40	0104284	F404 A 40/0.3	2CCF544130E0400			
	30	63	0104291	F404 A 63/0.03	2CCF544110E0630			
	100	63	0104307	F404 A 63/0.1	2CCF544120E0630			
	300	63	0104314	F404 A 63/0.3	2CCF544130E0630			

F404 A type $16^2/3 \text{ Hz}$

Function: protection against the effects of sinusoidal alternating and direct pulsating earth fault currents; protection against indirect contacts and additional protection against direct (with $I_{\Delta n} = 30 \text{ mA}$) contacts.

The RCCB F200 $16^2/3 \text{ Hz}$ can work at rated frequency of $16^2/3 \text{ Hz}$ which is common in railways applications



Application: railways

Standard: IEC/ EN 61008

Marking: according to EN 61008

Number of poles	Rated residual current $I_{\Delta n} \text{ mA}$	Rated current $I_n \text{ A}$	Bbn 761227 EAN	Order details		Price 1 piece	Weight 1 piece kg	Pack unit pc.
				Type code	Order code			
4	30	63	0104376	F404 A-LF 63/0.03	2CCF544110E0631	0.430	1	
	300	63	0104383	F404 A-LF 63/0.3	2CCF544130E0631			

SMISLINE TP plug-in system

RCCB F404 series - B    type for continuous, selective continuous type fault currents technical features



F 404 B

F404 B RCCBs provide additional protection against direct contact and are the right choice to ensure maximum system safety thanks to early detection of fault currents with continuous waveforms or high frequencies.

Number of poles	Rated residual current I Δ n mA	Rated current In A	Bbn 761227 EAN	Order details		Price 1 piece	Weight 1 piece kg	Pack unit pc.
				Type code	Order code			
4	30	25	1506285	F404B-25/0.03	2CCG000052R0001		0.435	1
4	30	40	1506292	F404B-40/0.03	2CCG000053R0001		0.435	1
4	30	63	1506308	F404B-63/0.03	2CCG000054R0001		0.435	1
4	300	25	1506315	F404B-25/0.3	2CCG000055R0001		0.435	1
4	300	40	1506322	F404B-40/0.3	2CCG000056R0001		0.435	1
4	300	63	1506339	F404B-63/0.3	2CCG000057R0001		0.435	1

SMISLINE TP plug-in system

RCCBs F400 series, A K  type



F402

F402 A K type, short-time delayed

Function: protection against the effects of sinusoidal alternating and direct pulsating earth fault currents, providing the best compromise between safety and continuity in the service thanks to the resistance to unwanted trippings; protection against indirect contacts and additional protection against direct ($I_{\Delta n} = 30 \text{ mA}$) contacts.

Application: residential, commercial, industrial.

Standard: IEC/EN 61008

Surge current resistance (wave 8/20) = 3000 A

Marking: according to EN 61008

Number of poles	Rated residual current $I_{\Delta n}$ mA	Rated current I_n A	Bbn 761227 EAN	Order details		Price 1 piece	Weight 1 piece kg	Pack unit pc.
				Type code	Order code			
2	30	40	0104482	F402 A-K 40/0.03	2CCF552310E0400		0.250	1



FS 404 K and S

F404 A K type, short-time delayed

Function: protection against the effects of sinusoidal alternating and direct pulsating earth fault currents, providing the best compromise between safety and continuity in the service thanks to the resistance to unwanted trippings; protection against indirect contacts and additional protection against direct ($I_{\Delta n} = 30 \text{ mA}$) contacts.

Application: residential, commercial, industrial.

Standard: IEC/EN 61008

Surge current resistance (wave 8/20) = 3000 A

Marking: according to EN 61008

Number of poles	Rated residual current $I_{\Delta n}$ mA	Rated current I_n A	Bbn 761227 EAN	Order details		Price 1 piece	Weight 1 piece kg	Pack unit pc.
				Type code	Order code			
4	30	40	0104321	F404 A-K 40/0.03	2CCF544310E0400		0.430	1
	100	40	0104338	F404 A-K 40/0.1	2CCF544320E0400		0.430	1
	30	63	0104345	F404 A-K 63/0.03	2CCF544310E0630		0.430	1

F404 A selective type

Function: protection against the effects of sinusoidal alternating and direct pulsating earth fault currents with an intentional tripping delay, which permits to realize the selectivity with downstream instantaneous devices (for more information about selectivity see the technical guide); protection against indirect contacts.

Application: commercial, industrial.

Standard: IEC/EN 61008

Surge current resistance (wave 8/20) = 5000 A

Marking: according to EN 61008

Number of poles	Rated residual current $I_{\Delta n}$ mA	Rated current I_n A	Bbn 761227 EAN	Order details		Price 1 piece	Weight 1 piece kg	Pack unit pc.
				Type code	Order code			
4	100	63	0104352	F404 A-S 63/0.1	2CCF544220E0630		0.430	1
	300	63	0104369	F404 A-S 63/0.3	2CCF544230E0630		0.430	1

Residual current operated circuit breaker (RCBO)

The difference lies in the detail

Residual current operated circuit breakers with overcurrent protection (RCBO)

The SMISLINE residual current operated circuit breakers with overcurrent protection (RCBO) are ideal for protecting people and property in all new and existing distribution systems. The combination of standby current and cable protection in one single device greatly simplifies planning and offers cost benefits. Using a RCBO can e.g. satisfy the minimum level of protection required by regulations in an apartment or in a particular distribution system. Should a residual current arise, only the circuit directly affected is switched off while all other circuits remain in operation.

The short time-delayed residual current operated circuit breaker with overcurrent protection FS401 K is a version particularly suited to unfavourable distribution and load situations. Without limiting the personal protection function in any way, the electronic short time delay prevents nuisance tripping which may arise as a result of capacitive discharge currents.

Type F RCBOs have a minimum non-tripping time of 10 ms and a surge current withstand capacity (resistance against accidental tripping) of 3 kA. The standard functionality is not impaired by overlapping smooth DC residual currents of up to 10 mA. When using Type F RCBOs with short-time delay, there is no risk of false tripping due to (capacitive) currents flowing to ground for short periods.

Reliable recognition of the switching status through the new red/green position indicating device that shows the position of the inner contacts.

Short-circuit breaking capacity of 10 kA to 32 A according to EN/IEC 61009-1
 Rated breaking capacity I_{cu} kA
 6...16 A and 15 kA 20...32 A acc. to IEC/EN 60947-2.

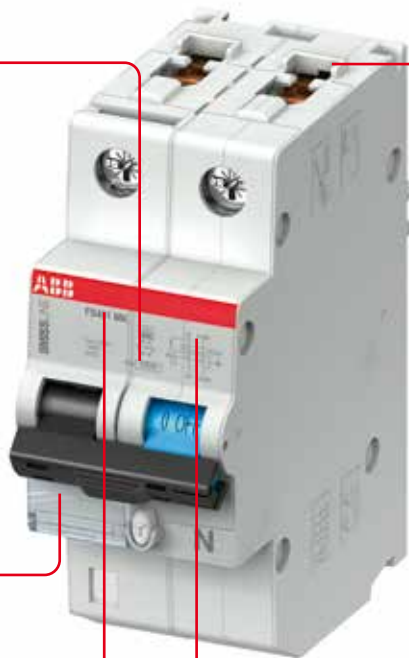

New, patented bidirectional terminal with captive screws for maximum comfort, safety and flexibility. The connection takes place in two chambers (35 mm² and 10 mm²). Two conductors with the same cross-section can be connected in each chamber.

Laser printing for clearly legible information during the entire service life.

SMISLINE TP plug-in system

Residual current operated circuit breaker (RCBO)

FS401 technical features

	FS401E	FS401M	FS401MK
Standards	IEC/EN 61009-1, IEC/EN 61009-2-1	IEC/EN 61009-1, IEC/EN 61009-2-1	IEC/EN 61009-1, IEC/EN 61009-2-1 IEC/EN 62423
Electrical features			
type (wave form of the earth leakage sensed)	A	A	APR - F
Number of poles	1P + N	1P + N	1P + N
Rated current I_n	$6 \leq I_n \leq 32A$	$6 \leq I_n \leq 32A$	$6 \leq I_n \leq 32A$
Rated sensitivity $I_{\Delta n}$	0.03A	0.03–0.1 A	0.03–0.3 A
Rated voltage U_e	240V	240V	240V
Insulation voltage U_i	500V	500V	500V
Overvoltage category	III	III	III
Pollution degree	2	2	2
Operating voltage of circuit test	110V (170 for 30mA) – 264	110V (170 for 30mA) – 264	110V (170 for 30mA) – 264
Rated frequency	50/60Hz	50/60Hz	50/60Hz
Rated breaking capacity acc. to IEC/EN 61009-1 I_{cn}	6000A	10000A	10000A
Rated breaking capacity acc. to IEC/EN 60947-2 (only referring to short circuit test)	ultimate I_{cu} kA 6...16 A ultimate I_{cu} kA 20...32 A service I_{cs} kA 6...16A service I_{cs} kA 20...32A	25 15 15 7.5	25 15 15 7.5
Rated residual breaking capacity acc. to IEC/EN 61009-1 $I_{\Delta m}$	6000A	10000A	10000A
Rated impulse withstand voltage (1.2/50) U_{imp}	4kV	4kV	4kV
Dielectric test voltage at ind. freq. for 1 min.	2.5 kV (50/60Hz, 1 min.)	2.5 kV (50/60Hz, 1 min.)	2.5 kV (50/60Hz, 1 min.)
Thermomagnetic release – characteristic	B: $3 I_n \leq I_n \leq 5 I_n$ C: $5 I_n \leq I_n \leq 10 I_n$	X X	X X
Energy limiting class acc. to EN 61009-1	3	3	3
Mechanical features			
Housing	Insulation group I, light grey RAL 7035	Insulation group I, light grey RAL 7035	Insulation group I, light grey RAL 7035
Toggle	Insulation group II, black RAL 9005, sealable in ON-OFF positions	Insulation group II, black RAL 9005, sealable in ON-OFF positions	Insulation group II, black RAL 9005, sealable in ON-OFF positions
Contact position indication	Green/Red Window	Green/Red Window	Green/Red Window
Endurance	Electrical endurance: 10000 ops Mechanical endurance: 10000 ops		
IP code	IP20, IP40 in enclosure with cover	IP20, IP40 in enclosure with cover	IP20, IP40 in enclosure with cover
Shock resistance acc. to IEC/EN 61373	5g–30ms, 3 shocks	5g–30ms, 3 shocks	5g–30ms, 3 shocks
Vibration resistance acc. to IEC/EN 60068-2-6	2...13.2 Hz/1 mm 13.2...100Hz/0.7g, 5 cycles 5...150 ... 5 Hz/1g, 4 waves	2...13.2 Hz/1 mm 13.2...100Hz/0.7g, 5 cycles 5...150 ... 5 Hz/1g, 4 waves	2...13.2 Hz/1 mm 13.2...100Hz/0.7g, 5 cycles 5...150 ... 5 Hz/1g, 4 waves
Reference temperature for setting of thermal element	30 °C	30 °C	30 °C
Ambient temperature	–25...+60 °C	–25...+60 °C	–25...+60 °C
Storage temperature	–40...+70 °C	–40...+70 °C	–40...+70 °C
Installation			
Terminal type	failsafe bi-directional cylinder-lift terminal (shock protected)		
Top terminal rigid IEC connections (solid/stranded)	Single: 0.75 ÷ 35 mm ² (front slot), 0.75 ÷ 10 mm ² (rear slot) Multiple: 2x0.75 ÷ 10 mm ² (front slot), 2x0.75 ÷ 6 mm ² (rear slot), with cables of same type and size		
Top terminal flexible IEC connections	Single: 0.75 ÷ 25 mm ² (front side), 0.75 ÷ 6 mm ² (rear slot) Multiple: 2x0.75 ÷ 10 mm ² (front slot), 2x0.75 ÷ 6 mm ² (rear slot), with cables of same type and size		

SMISLINE TP plug-in system

RCBOs FS401 series $\boxed{10000}$ - $\boxed{6000}$ A $\boxed{\Delta}$ type



FS 401 M

FS401E A type, B and C characteristic

Function: protection of end user single-phase circuits against overload and short-circuit currents; protection against the effects of sinusoidal alternating and direct pulsating earth fault currents; protection against indirect contact and additional protection against direct contact ($I_{\Delta n}=30$ mA).

Application: residential, commercial, industrial.

Standard: IEC/EN 61009, $I_{cn} = 6$ kA, $I_{cn} = 10$ kA

B, 6 kA according to EN 61009-1

$I_{\Delta n}$	I_n	I_{cn}	Bbn 761227	Order details		Module	Weight 1 piece	Pack unit
[mA]	[A]	[kA]	EAN	Type code	Order code		kg	pc.
30	10	6	1472825	FS401 E-B 10/0.03	2CCL562111E1105	2	0.2	1
30	13	6	0108558	FS401 E-B 13/0.03	2CCL562111E0135	2	0.2	1
30	16	6	0108565	FS401 E-B 16/0.03	2CCL562111E0165	2	0.2	1
30	20	6	0109692	FS401 E-B 20/0.03	2CCL562111E0205	2	0.2	1
30	25	6	0109708	FS401 E-B 25/0.03	2CCL562111E0255	2	0.2	1
30	32	6	0109715	FS401 E-B 32/0.03	2CCL562111E0325	2	0.2	1

C, 6 kA according to EN 61009-1

30	6	6	1472788	FS401 E-C 6/0.03	2CCL562111E1064	2	0.2	1
30	10	6	1472801	FS401 E-C 10/0.03	2CCL562111E1104	2	0.2	1
30	13	6	0108572	FS401 E-C 13/0.03	2CCL562111E0134	2	0.2	1
30	16	6	0108589	FS401 E-C 16/0.03	2CCL562111E0164	2	0.2	1
30	20	6	0104574	FS401 E-C 20/0.03	2CCL562110E0204	2	0.2	1
30	25	6	0104581	FS401 E-C 25/0.03	2CCL562110E0254	2	0.2	1
30	32	6	0104598	FS401 E-C 32/0.03	2CCL562110E0324	2	0.2	1

B, 10 kA according to EN 61009-1

30	6	10	1472641	FS401 M-B 6/0.03	2CCL562110E1065	2	0.2	1
30	10	10	0109685	FS401 M-B 10/0.03	2CCL562110E0105	2	0.2	1
30	13	10	0104505	FS401 M-B 13/0.03	2CCL562110E0135	2	0.2	1
30	16	10	0104512	FS401 M-B 16/0.03	2CCL562110E0165	2	0.2	1
30	20	10	1472689	FS401 M-B 20/0.03	2CCL562110E1205	2	0.2	1
30	25	10	1472726	FS401 M-B 25/0.03	2CCL562110E1255	2	0.2	1
30	32	10	1472764	FS401 M-B 32/0.03	2CCL562110E1325	2	0.2	1

C, 10 kA according to EN 61009-1

30	6	10	1406905	FS401 M-C 6/0.03	2CCL562010E0064	2	0.2	1
30	10	10	0104543	FS401 M-C 10/0.03	2CCL562110E0104	2	0.2	1
30	13	10	0104550	FS401 M-C 13/0.03	2CCL562110E0134	2	0.2	1
30	16	10	0104567	FS401 M-C 16/0.03	2CCL562110E0164	2	0.2	1
30	20	10	1472665	FS401 M-C 20/0.03	2CCL562110E1204	2	0.2	1
30	25	10	1472702	FS401 M-C 25/0.03	2CCL562110E1254	2	0.2	1
30	32	10	1472740	FS401 M-C 32/0.03	2CCL562110E1324	2	0.2	1
100	6	10	142 4534	FS401 M-C6/0.1	2CCL562120E0064	2	0.2	1
100	10	10	1413217	FS401 M-C10/0.1	2CCL562120E0104	2	0.2	1
100	13	10	1490706	FS401 M-C13/0.1	2CCL562120E0134	2	0.2	1
100	16	10	1421618	FS401 M-C16/0.1	2CCL562120E0164	2	0.2	1
100	20	10	1490720	FS401 M-C20/0.1	2CCL562122E0204	2	0.2	1
100	25	10	1490744	FS401 M-C25/0.1	2CCL562122E0254	2	0.2	1
100	32	10	1490768	FS401 M-C32/0.1	2CCL562122E0324	2	0.2	1

SMISLINE TP plug-in system

RCBOs FS401 series $10\,000$ A K  Type F



FS401 M

FS401 M A K type, short-time delayed

Function: protection against the effects of sinusoidal alternating and direct pulsating earth fault currents, providing an optimal compromise between safety and continuity of service, thanks to the resistance to unwanted tripping; protection against indirect contact and additional protection against direct ($I_{\Delta n} = 30\text{ mA}$) contact; protection and isolation of resistive and inductive loads.

Application: residential, commercial, industrial.

Standard: IEC/EN 61009

$I_{cn} = 10\text{ kA}$

B, 10 kA according to EN 61009-1

$I_{\Delta n}$	I_n	I_{cn}	Bbn 761227	Order details		Module	Weight 1 piece	Pack unit
[mA]	[A]	[kA]	EAN	Type code	Order code		kg	pc.
30	6	10	1472849	FS401 M K-B 6/0.03	2CCL562130E1035	2	0.2	1
30	10	10	1472887	FS401 M K-B 10/0.03	2CCL562310E1105	2	0.2	1
30	13	10	1472900	FS401 M K-B 13/0.03	2CCL562310E1135	2	0.2	1
30	16	10	1472924	FS401 M K-B 16/0.03	2CCL562310E1165	2	0.2	1
30	20	6	1472962	FS401 M K-B 20/0.03	2CCL562310E1205	2	0.2	1
30	25	6	1473006	FS401 M K-B 25/0.03	2CCL562310E1255	2	0.2	1
30	32	6	1473044	FS401 M K-B 32/0.03	2CCL562310E1325	2	0.2	1

C, 10 kA according to EN 61009-1

30	6	10	1404031	FS401 M K-C 6/0.03	2CCL562330E1064	2	0.2	1
30	10	10	1404031	FS401 M K-C 10/0.03	2CCL562310E0104	2	0.2	1
30	13	10	0104604	FS401 M K-C 13/0.03	2CCL562310E0134	2	0.2	1
30	16	10	0104611	FS401 M K-C 16/0.03	2CCL562310E0164	2	0.2	1
30	20	6	0104642	FS401 M K-C 20/0.03	2CCL562310E1204	2	0.2	1
30	25	6	0104642	FS401 M K-C 25/0.03	2CCL562310E1254	2	0.2	1
30	32	6	0104642	FS401 M K-C 32/0.03	2CCL562310E1324	2	0.2	1

C, 10 kA according to EN 61009-1

300	6	10	1473068	FS401 M K-C 6/0.3	2CCL562130E3034	2	0.2	1
300	10	10	1473082	FS401 M K-C 10/0.3	2CCL562330E1104	2	0.2	1
300	13	10	1473105	FS401 M K-C 13/0.3	2CCL562330E1134	2	0.2	1
300	16	10	1473143	FS401 M K-C 16/0.3	2CCL562330E1164	2	0.2	1
300	20	10	1473181	FS401 M K-C 20/0.3	2CCL562330E1204	2	0.2	1
300	25	10	1473228	FS401 M K-C 25/0.3	2CCL562330E1254	2	0.2	1
300	32	10	1473266	FS401 M K-C 32/0.3	2CCL562330E1324	2	0.2	1

SMISLINE TP plug-in system

RCBOs FS403 series $\boxed{10000}$ - $\boxed{6000}$ A $\boxed{\text{A}}$ type and short time delay Type F



FS 403 M

4-pole RCBO from the ABB SMISLINE protective devices range

The combination of circuit protection and a residual current protection in one device as 4-pole RCBO simplifies both – planning and installation. It enables you to provide perfect protection in one device. This protection consists of:

- Short circuit protection
- Overload protection
- Residual current protection
- Preventive fire protection

High rated short-circuit breaking capacity of 10 kA, conforming to EN 61009-1

The I_{cn} 10 kA short-circuit breaking capacity of the RCBO complies with standard EN 61009-1. This standard specifies testing and usage of RCBO's for household and similar uses.

The devices can also be used by non-professionals.

Features and benefits of the new devices:

- Overall width of 72 mm (4 modules)
- Rated sensitivity 30 mA
- Current rating 10 A to 32 A
- B and C tripping characteristics
- Easy Drive double deck terminals on the output side for connecting two conductors in one chamber. The two chambers can accommodate conductors with different cross sections.

Accessory:

Auxiliary- and signal contacts are to attach on to the left of the device through the customer.

Please notice:

For the influence of the ambient temperature and the thermal influences of row mounted RCBO's it is necessary to calculate with the same correction factors like with MCBs.

Please see in Chapter 2 of Electrical installation solutions for buildings - Technical details.

SMISLINE TP plug-in system

Residual current operated circuit breaker (RCBO)

FS403 technical features

	FS403E	FS403M	FS403MK
Standards	IEC 61009-1, EN 61009-1, EN 61009-2-1	IEC 61009-1, EN 61009-1, EN 61009-2-1	IEC/EN 61009-1, IEC/EN 61009-2-1, IEC/EN 62423
Electrical features			
type (wave form of the earth leakage sensed)	A	A	APR - F
Number of poles	3P + N	3P + N	3P + N
Rated current I_n	$6 \leq I_n \leq 32\text{A}$	$6 \leq I_n \leq 32\text{A}$	$6 \leq I_n \leq 32\text{A}$
Rated sensitivity $I_{\Delta n}$	0.03A	0.03–0.1 A	0.03–0.3A
Rated voltage U_e	240/415V	240/415V	240/415V
Insulation voltage U_i	500V	500V	500V
Overvoltage category	III	III	III
Pollution degree	2	2	2
Operating voltage of circuit test	110V (170 for 30mA) – 264	110V (170 for 30mA) – 264	110V (170 for 30mA) – 264
Rated frequency	50/60Hz	50/60Hz	50/60Hz
Rated breaking capacity acc. to IEC/EN 61009-1 I_{cn}	6000A	10000A	10000A
Rated breaking capacity acc. to IEC/EN 60947-2 (only referring to short circuit test)	ultimate I_{cu} kA 6...16 A	25	25
	service I_{cs} kA 6...16A	15	15
	ultimate I_{cu} kA 20...32A	15	15
	service I_{cs} kA 20...32A	7.5	7.5
Rated residual breaking capacity acc. to IEC/EN 61009-1 $I_{\Delta m}$	6000A	10000A	10000A
Rated impulse withstand voltage (1.2/50) U_{imp}	4kV	4kV	4kV
Dielectric test voltage at ind. freq. for 1 min.	2.5kV (50/60Hz, 1 min.)	2.5kV (50/60Hz, 1 min.)	2.5kV (50/60Hz, 1 min.)
Thermomagnetic release – characteristic	B: $3 I_n \leq I_n \leq 5 I_n$	X	X
	C: $5 I_n \leq I_n \leq 10 I_n$	X	X
Energy limiting class acc. to EN 61009-1	3	3	3
Mechanical features			
Housing	Insulation group I, light grey RAL 7035	Insulation group I, light grey RAL 7035	Insulation group I, light grey RAL 7035
Toggle	Insulation group II, black RAL 9005, sealable in ON-OFF positions	Insulation group II, black RAL 9005, sealable in ON-OFF positions	Insulation group II, black RAL 9005, sealable in ON-OFF positions
Contact position indication	Green/Red Window	Green/Red Window	Green/Red Window
Electrical life	10000 operations	10000 operations	10000 operations
Mechanical life	10000 operations	10000 operations	10000 operations
IP code	IP20, IP40 in enclosure with cover	IP20, IP40 in enclosure with cover	IP20, IP40 in enclosure with cover
Shock resistance acc. to IEC/EN 61373	5g–30ms, 3 shocks	5g–30ms, 3 shocks	5g–30ms, 3 shocks
Vibration resistance acc. to IEC/EN 60068-2-6	2...13.2Hz/1mm 13.2...100Hz/0.7g, 5 cycles 5...150 ... 5 Hz/1g, 4 waves	2...13.2Hz/1mm 13.2...100Hz/0.7g, 5 cycles 5...150 ... 5 Hz/1g, 4 waves	2...13.2Hz/1mm 13.2...100Hz/0.7g, 5 cycles 5...150 ... 5 Hz/1g, 4 waves
Reference temperature for setting of thermal element	30°C	30°C	30°C
Ambient temperature	–25...+60°C	–25...+60°C	–25...+60°C
Storage temperature	–40...+70°C	–40...+70°C	–40...+70°C
Installation			
Terminal type	failsafe bi-directional cylinder-lift terminal (shock protected)		
Top terminal rigid IEC connections (solid/stranded)	Single: 0.75 ÷ 35 mm ² (front slot), 0.75 ÷ 10 mm ² (rear slot) Multiple: 2×0.75 ÷ 10 mm ² (front slot), 2×0.75 ÷ 6 mm ² (rear slot), with cables of same type and size		
Top terminal flexible IEC connections	Single: 0.75 ÷ 25 mm ² (front side), 0.75 ÷ 6 mm ² (rear slot) Multiple: 2×0.75 ÷ 10 mm ² (front slot), 2×0.75 ÷ 6 mm ² (rear slot), with cables of same type and size		

SMISLINE TP plug-in system

RCBOs FS403 series $\boxed{10000}$ - $\boxed{6000}$ A $\boxed{\Delta}$ type and short time delay Type F



FS 403 M

FS403 M A type, B and C characteristic

Function: protection of end user single-phase circuits against overload and short-circuit currents; protection against the effects of sinusoidal alternating and direct pulsating earth fault currents; protection against indirect contact and additional protection against direct contact ($I\Delta n = 30 \text{ mA}$).

Application: residential, commercial, industrial.

Standard: IEC/EN 61009, $I_{cn} = 6 \text{ kA}$, $I_{cn} = 10 \text{ kA}$

B, 10kA according to EN 61009-1

Poles	Sensitivity $I\Delta n \text{ mA}$	Rated current $I_n \text{ A}$	Rated breaking capacity $I_{cn} \text{ kA}$	Bbn 761227 EAN	Order details		Price 1 piece	Weight 1 piece kg	Pack unit pc.
					Type code	Order code			
4	30	6	10	1434434	FS403M-B6/0.03	2CCL564110E0065		0.410	1
		10	10	1407612	FS403M-B10/0.03	2CCL564110E0105		0.410	1
		13	10	1407629	FS403M-B13/0.03	2CCL564110E0135		0.410	1
		16	10	1407636	FS403M-B16/0.03	2CCL564110E0165		0.410	1
		20	10	1442576	FS403M-B20/0.03	2CCL563110E0205		0.410	1
		25	10	1442590	FS403M-B25/0.03	2CCL563110E0255		0.410	1
		32	10	1442613	FS403M-B32/0.03	2CCL563110E0325		0.410	1

C, 6kA according to EN 61009-1

Poles	Sensitivity $I\Delta n \text{ mA}$	Rated current $I_n \text{ A}$	Rated breaking capacity $I_{cn} \text{ kA}$	Bbn 761227 EAN	Order details		Price 1 piece	Weight 1 piece kg	Pack unit pc.
					Type code	Order code			
4	30	6	6	1419141	FS403E-C6/0.03	2CCL564111E0064		0.410	1
		10	6	1434489	FS403E-C10/0.03	2CCL564111E0104		0.410	1
		13	6	1434519	FS403E-C13/0.03	2CCL564111E0134		0.410	1
		16	6	1434601	FS403E-C16/0.03	2CCL564111E0164		0.410	1
		20	6	1409609	FS403E-C20/0.03	2CCL564111E0203		0.410	1
		25	6	1408770	FS403E-C25/0.03	2CCL564111E0254		0.410	1
		32	6	1408787	FS403E-C32/0.03	2CCL564111E0324		0.410	1

C, 10kA according to EN 61009-1

Poles	Sensitivity $I\Delta n \text{ mA}$	Rated current $I_n \text{ A}$	Rated breaking capacity $I_{cn} \text{ kA}$	Bbn 761227 EAN	Order details		Price 1 piece	Weight 1 piece kg	Pack unit pc.
					Type code	Order code			
4	30	6	10	1419127	FS403M-C6/0.03	2CCL564110E0064		0.410	1
		10	10	1407674	FS403M-C10/0.03	2CCL564110E0104		0.410	1
		13	10	1407681	FS403M-C13/0.03	2CCL564110E0134		0.410	1
		16	10	1407698	FS403M-C16/0.03	2CCL564110E0164		0.410	1
		20	10	1442569	FS403M-C20/0.03	2CCL563110E0204		0.410	1
		25	10	1442583	FS403M-C25/0.03	2CCL563110E0254		0.410	1
		32	10	1442606	FS403M-C32/0.03	2CCL563110E0324		0.410	1

C, 10kA according to EN 61009-1

Poles	Sensitivity $I\Delta n \text{ mA}$	Rated current $I_n \text{ A}$	Rated breaking capacity $I_{cn} \text{ kA}$	Bbn 761227 EAN	Order details		Price 1 piece	Weight 1 piece kg	Pack unit pc.
					Type code	Order code			
4	100	6	6	1424527	FS403M-C6/0.1	2CCL564121E0064		0.410	1
		10	10	1424510	FS403M-C10/0.1	2CCL564121E0104		0.410	1
		13	10	1442620	FS403M-C13/0.1	2CCL563120E0134		0.410	1
		16	10	1420109	FS403M-C16/0.1	2CCL564120E0164		0.410	1
		20	10	1442637	FS403M-C20/0.1	2CCL563120E0204		0.410	1
		25	10	1442644	FS403M-C25/0.1	2CCL563120E0254		0.410	1
		32	10	1442651	FS403M-C32/0.1	2CCL563120E0324		0.410	1

SMISLINE TP plug-in system

RCBOs FS403 series $\boxed{10000}$ - $\boxed{6000}$ A $\boxed{\Delta}$ type and short time delay Type F



FS 403 M

B, 10 kA according to EN61009-1 short time delayed (APR) Type F

Poles	Sensitivity $I\Delta n$ mA	Rated current I_n A	Rated breaking capacity I_{cn} kA	Bbn 761227 EAN	Order details		Price 1 piece	Weight 1 piece kg	Pack unit pc.
					Type code	Order code			
4	30	6	10	1470951	FS403MK-B6/0.03	2CCL564310E0065		0.410	1
		10	10	1470999	FS403MK-B10/0.03	2CCL564310E0105		0.410	1
		13	10	1471033	FS403MK-B13/0.03	2CCL564310E0135		0.410	1
		16	10	1471071	FS403MK-B16/0.03	2CCL564310E0165		0.410	1
		20	10	1470777	FS403MK-B20/0.03	2CCL564310E0205		0.410	1
		25	10	1470814	FS403MK-B25/0.03	2CCL564310E0255		0.410	1
		32	10	1470852	FS403MK-B32/0.03	2CCL564310E0325		0.410	1

C, 10 kA according to EN61009-1 short time delayed (APR) Type F

Poles	Sensitivity $I\Delta n$ mA	Rated current I_n A	Rated breaking capacity I_{cn} kA	Bbn 761227 EAN	Order details		Price 1 piece	Weight 1 piece kg	Pack unit pc.
					Type code	Order code			
4	30	6	10	1470937	FS403MK-C6/0.03	2CCL564310E0064		0.410	1
		10	10	1470975	FS403MK-C10/0.03	2CCL564310E0104		0.410	1
		13	10	1471019	FS403MK-C13/0.03	2CCL564310E0134		0.410	1
		16	10	1471057	FS403MK-C16/0.03	2CCL564310E0164		0.410	1
		20	10	1470753	FS403MK-C20/0.03	2CCL564310E0204		0.410	1
		25	10	1470791	FS403MK-C25/0.03	2CCL564310E0254		0.410	1
		32	10	1470838	FS403MK-C32/0.03	2CCL564310E0324		0.410	1

C, 10kA according to EN 61009-1

Poles	Sensitivity $I\Delta n$ mA	Rated current I_n A	Rated breaking capacity I_{cn} kA	Bbn 761227 EAN	Order details		Price 1 piece	Weight 1 piece kg	Pack unit pc.
					Type code	Order code			
4	300	6	10	1471095	FS403MK-C6/0.3	2CCL564330E0064		0.410	1
		10	10	1471118	FS403MK-C10/0.3	2CCL564330E0104		0.410	1
		13	10	1471132	FS403MK-C13/0.3	2CCL564330E0134		0.410	1
		16	10	1471156	FS403MK-C16/0.3	2CCL564330E0164		0.410	1
		20	10	1470876	FS403MK-C20/0.3	2CCL563330E0204		0.410	1
		25	10	1470890	FS403MK-C25/0.3	2CCL563330E0254		0.410	1
		32	10	1470913	FS403MK-C32/0.3	2CCL563330E0324		0.410	1

SMISLINE TP plug-in system

Residual current operated circuit breaker (RCBO)

FS402 technical features

FS402-MK		
Standards	IEC/EN 61009-1, IEC/EN 61009-2-1, IEC/EN 62423	
Electrical features		
type (wave form of the earth leakage sensed)	APR - F	
Number of poles	1p + N (protected)	
Rated current I_n	$6 \leq I_n \leq 32$ A	
Rated sensitivity $I_{\Delta n}$	0.03	
Rated voltage U_e	240/415 V	
Insulation voltage U_i	500 V	
Overvoltage category	III	
Pollution degree	2	
Operating voltage of circuit test	110 V (170 for 30 mA) – 264	
Rated frequency	50/60 Hz	
Rated breaking capacity acc. to IEC/EN 61009-1 I_{cn}	10000 A	
Rated breaking capacity acc. to IEC/EN 60947-2 (only referring to short circuit test)	ultimate I_{cu} kA 6...16 A	25
	service I_{cs} kA 6...16 A	15
	ultimate I_{cu} kA 20...32 A	15
	service I_{cs} kA 20...32 A	7.5
Rated residual breaking capacity acc. to IEC/EN 61009-1 $I_{\Delta m}$	10000 A	
Rated impulse withstand voltage (1.2/50) U_{imp}	4 kV	
Dielectric test voltage at ind. freq. for 1 min.	2.5 kV (50/60 Hz, 1 min.)	
Thermomagnetic release – characteristic	B: $3 I_n \leq I_n \leq 5 I_n$	X
	C: $5 I_n \leq I_n \leq 10 I_n$	X
Energy limiting class acc. to EN 61009-1	3	
Mechanical features		
Housing	Insulation group I, light grey RAL 7035	
Toggle	Insulation group II, black RAL 9005, sealable in ON-OFF positions	
Contact position indication	Green/Red Window	
Electrical life	10000 operations	
Mechanical life	10000 operations	
IP code	IP20, IP40 in enclosure with cover	
Shock resistance acc. to IEC/EN 61373	5g–30ms, 3 shocks	
Vibration resistance acc. to IEC/EN 60068-2-6	2...13.2 Hz/1 mm	
	13.2...100 Hz/0.7g, 5 cycles	
	5...150 ... 5 Hz/1 g, 4 waves	
Reference temperature for setting of thermal element	30 °C	
Ambient temperature	–25...+60 °C	
Storage temperature	–40...+70 °C	
Installation		
Terminal type	failsafe bi-directional cylinder-lift terminal (shock protected)	
Top terminal rigid IEC connections (solid/stranded)	Single: $0.75 \div 35 \text{ mm}^2$ (front slot), $0.75 \div 10 \text{ mm}^2$ (rear slot) Multiple: $2 \times 0.75 \div 10 \text{ mm}^2$ (front slot), $2 \times 0.75 \div 6 \text{ mm}^2$ (rear slot), with cables of same type and size	
Top terminal flexible IEC connections	Single: $0.75 \div 25 \text{ mm}^2$ (front side), $0.75 \div 6 \text{ mm}^2$ (rear slot) Multiple: $2 \times 0.75 \div 10 \text{ mm}^2$ (front slot), $2 \times 0.75 \div 6 \text{ mm}^2$ (rear slot), with cables of same type and size	

RCBOs (1P+N)

FS402 series 10 000 F type, AP-R (high immunity)

B and C characteristics



FS 402

FS402 with protected neutral

B characteristic

Poles	Sensi- tivity $I_{\Delta n}$ mA	Rated current I_n A	Rated breaking capacity I_{cn} kA	Bbn 761227 EAN	Order details		Price 1 piece	Weight 1 piece kg	Pack unit pc.
					Type code	Order code			
2	30	6	10	1473365	FS402MK-B6/0.03	2CCL563130E1035	3	0.312	
		10	10	1473778	FS402MK-B10/0.03	2CCL563010E0105	3	0.312	
		13	10	1473402	FS402MK-C13/0.03	2CCL563310E1324	3	0.312	
		16	10	1474010	FS402MK-B16/0.03	2CCL563010E0165	3	0.312	
		20	10	1474058	FS402MK-B20/0.03	2CCL563010E0205	3	0.312	
		25	10	1474096	FS402MK-B25/0.03	2CCL563010E0255	3	0.312	
		32	10	1474133	FS402MK-B32/0.03	2CCL563010E0325	3	0.312	

C characteristic

2	30	6	10	1473341	FS402MK-C6/0.03	2CCL563130E1034	3	0.312
		10	10	1473754	FS402MK-C10/0.03	2CCL563010E0104	3	0.312
		13	10	1473389	FS402MK-B13/0.03	2CCL563310E1135	3	0.312
		16	10	1473792	FS402MK-C16/0.03	2CCL563010E0164	3	0.312
		20	10	1474034	FS402MK-C20/0.03	2CCL563010E0204	3	0.312
		25	10	1474072	FS402MK-C25/0.03	2CCL563010E0254	3	0.312
		32	10	1474119	FS402MK-C32/0.03	2CCL563010E0324	3	0.312

SMISLINE TP plug-in system

Surge arrester



The type 2 surge arresters in the QuickSafe product range are suitable for protecting electrical low voltage systems and terminals in the 240/415V system. The devices can be used as type 2 surge arresters within the scope of the lightning protection zone concept at zone transition OB-1 and higher. The high nominal discharge capability of 20 kA makes it possible for the equipment to have a longer service life in comparison to the minimum requirements of the standard. The devices consist of a basic unit and pluggable protection modules, which can be removed extremely easily to carry out insulation measurement. They are fully compatible with SMISLINE installation devices and the surge arresters in the ABB System pro M model series. The surge arresters are tested as type 2 arresters in accordance with the EN/IEC 61643-11 test standard.

Mounting

Installation and electrical connection

The over voltage protection device "OVR" will be installed near the front of the protected consumers conditioning.

The surge arrester is to be mounted right after the Incoming block of the socket system. The OVR404 is snapped directly onto the SMISLINE bus bar system.

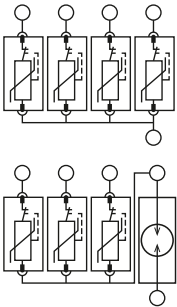

SMISLINE TP plug-in system

Surge arrester

Type	OVR404 4L 40-275 P TS QS	OVR404 3N 40-275 P TS QS
Technologie	varistor	Varistor/gaz tube (N)
System network	TNS	TT-TNS
Electrical features		
Standard	IEC 61643-11/EN 61643-11	IEC 61643-11/EN 61643-11
Type / test class	Type 2	Type 2
Number of pole	4	4
Nominal voltage UN (L-N, L-L)	240/415 V	240/415 V
Type of voltage	a.c. 45–65 Hz	a.c. 45–65 Hz
Max. cont. operating voltage U_c	275 V AC	275 V AC
Nominal discharge current I_n (8/20)	20 kA	20 kA
Maximum discharge current I_{max} (8/20)	40 kA	40 kA
Maximum impulse current I_{imp} (10/350)	2 kV	2 kA
Voltage protection level U_p at I_n (L-N / N-PE / L-PE)	1.5 kV	1.25/1.4/1.5 kV
Voltage protection level U_p at 3 kA (L-N / N-PE / L-PE)	0.5 kV	0.8/1.4/0.85 kV
Voltage protection level U_p at 5 kA (L-N / N-PE / L-PE)	0.7 kV	0.85/1.4/0.95 kV
Voltage protection level U_p at 10 kA (L-N / N-PE / L-PE)	0.9 kV	1/1.4/1.15 kV
TOV (Temporary overvoltage) withstand U_t (L-N: 5s./N-PE: 200ms)	337/-V	337/1200 V
Response time	≤ 25 ns	≤ 25 ns
Short-circuit withstand capability I_{sc}	100 kA	100 kA
Back up protection circuit breaker	≤ 125 A; S800S B	≤ 125 A; S800S B
Pluggable cartridge	Yes	Yes
Integrated QuickSafe® technology	Yes	Yes
State indicator	Yes	Yes
Auxiliary contact (TS)	Yes	Yes
Installation		
Wire range (L, N, PE)	2.5...25 mm ² cable or rope	2.5...25 mm ² cable or rope
Connection cross-section	2.5...16 mm ² litz wire with ferrule	2.5...16 mm ² litz wire with ferrule
Tightening torque	2.8 Nm	2.8 Nm
Auxiliary contact (TS)		
Contacts information	1 NO – 1 NC	1 NO – 1 NC
Max. load/current	12 V DC – 10 mA	12 V DC – 10 mA
Min. load/current	250 V AC – 1 A	250 V AC – 1 A
	1.5 mm ²	1.5 mm ²
Operating temperature	–25 °C – +60 °C	–25 °C – +60 °C
Stocking temperature	–25 °C – +80 °C	–25 °C – +80 °C

Back up protection

Typ 2 QuickSafe® Surge Protective Devices	Prospective short circuit current at SPD location (I_p)	Circuit breaker maximum ratings 1) curve B or C	Fuse 2) (gL - gG)
Maximum ratings			
I_n : 5, 20, 30 kA	$0,625 \text{ kA} < I_p < 100 \text{ kA}$	S800S B or C – 125 A ²⁾	125 A fuse
U_c : 275, 350, 440, 600 V			

1) Maximum ratings, must be in accordance with the installation to follow coordination rules with main or upstream short circuit protection(s).

2) up to $I_p \leq 50 \text{ kA}$

SMISLINE TP plug-in system

Surge arrester



OVR404

Surge arrester OVR404

Rated current	Bbn 761227	Order details		Price 1 piece	Weight 1 piece	Pack unit
Isn (8/20μs) kA	EAN	Type code	Order code		kg	pc.
20	1455491	OVR404 4L 40-275 P TS QS	2CCF606000R0001		0.470	1
20	1455507	OVR404 3N 40-275 P TS QS	2CCF606002R0001		0.450	1
20	1465322	OVR404 4L 40-440 P TS QS	2CCF606000A0003		0.470	1

SMISLINE TP plug-in system

Switch disconnecter



IS404 63

Technical data for switch disconnecter IS404

Rated voltage Un	230/400V~
Rated current In	63 A
Rated frequency fn	50 Hz
Number of poles	4
Rated impulse withstand voltage	6 kV
Connection cross-sections Cu	Top terminal type: Failsafe bi-directional cylinder-lift terminal with double slot 25/10 mm ² Top terminal rigid IEC connections (solid/stranded): – Single: 0.75 ÷ 25 mm ² (front slot), 0.75 ÷ 10 mm ² (rear slot) – Multiple: 2 x 0.75 ÷ 10 mm ² (front slot), 2 x 0.75 ÷ 6 mm ² (rear slot), with cables of same type and size Top terminal flexible IEC connections: – Single: 0.75 ÷ 16 mm ² (front side), 0.75 ÷ 6 mm ² (rear slot) – Multiple: 2 x 0.75 ÷ 10 mm ² (front slot), 2 x 0.75 ÷ 6 mm ² (rear slot), with cables of same type and size
Degree of protection	IP20, IP40 in enclosure with cover
Endurance, mechanical/electrical	5000 operating cycles
Mounting position	any
Ambient temperature	–25 °C ... +60 °C
Specifications	EN/IEC 60947-3
Weight (approx.)	250 g
Switching duty	AC-22A
Environmental conditions (damp heat) acc. to IEC/EN 60068	-2-30 28 cycles with 55 °C/90...96 % and 25 °C/95...100 %

General switch disconnecter

When used in a smissline socket system, the switch disconnecter can be used instead of the incoming terminal block for up to 63 A.

With the smissline IS404 switch disconnecter, individual loads, groups of loads or entire system parts can be separated or connected to the input supply.

The key features of the switch disconnecter

- Input supply switch
- On-Off function
- Clear indication of switching position
- Snap-on auxiliary switch available
- Uniform smissline design

Switch disconnecter IS404

Rated current	Bbn	Order details		Price	Weight	Pack unit
In kA	EAN	Type code	Order code	1 piece	1 piece	pc.
63	0104390	IS404 63	2CCF544160E0630		0.380	1

SMISLINE TP plug-in system

Auxiliary elements and accessories

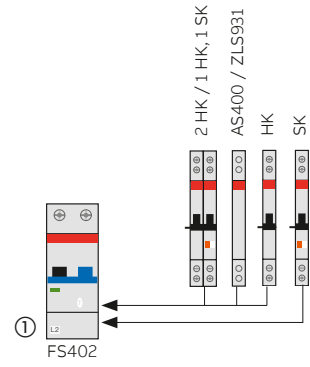
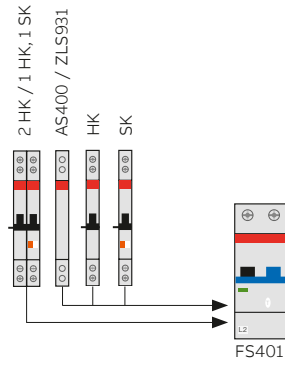
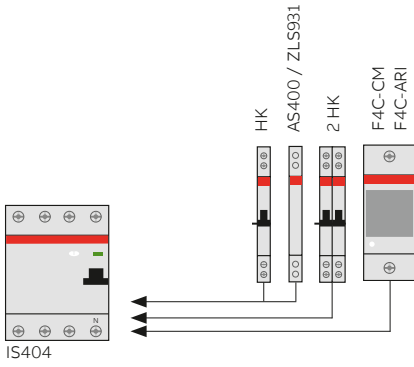
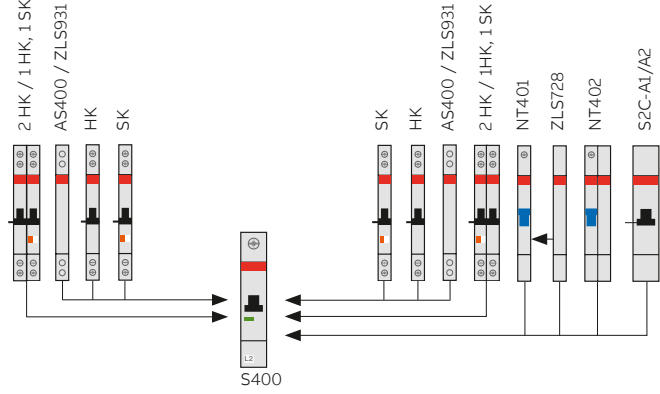
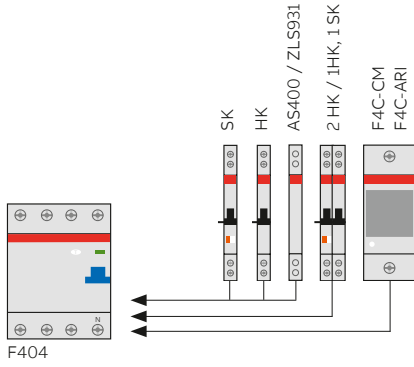

- On each protective device can be mounted:
- or 1 auxiliary switch
 - or 1 signal contact
 - or 2 auxiliary contact switches
 - or 1 auxiliary switch and 1 signal contact

Contact description signal contact

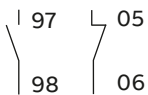

SK40011

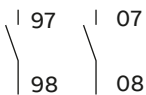

SK40020

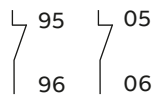

SK40002

Contact description auxiliary switch

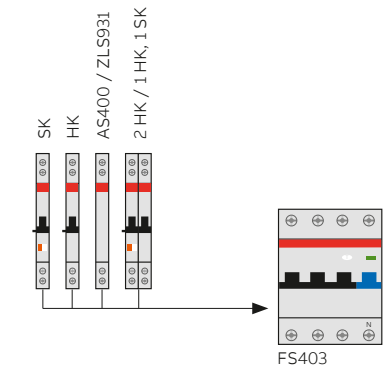
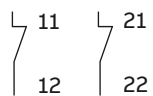
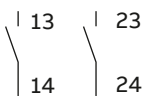
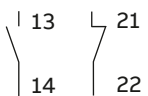

① If you use an auxiliary switch and a signal contact you must connect first the signal contact on the MS325

SMISSLINE TP plug-in system

Auxiliary switch and signal contacts

MCB S400, RCCB F404, RCCB F402, RCBO FS401

Technical data for auxiliary switch and signal contact

	Signal contact	Auxiliary switch
	SK400	HK400
Rated voltage U_n	400 V	400 V
Rated impulse withstand voltage	4 kV	4 kV
Rated current		
– I_{th}	6 A	6 A
– AC15	2 A/230 V / 1 A/400 V	2 A/230 V / 1 A/400 V
– DC13	0.55 A/125 V=	0.55 A/125 V=
– DC13	0.27 A/250 V=	0.27 A/250 V=
Minimum current/voltage (to ensure reliable electrical operation)	10 mA 12 V=	10 mA 12 V=
Connection cross-sections Rigid IEC connections (solid/stranded)	Single: 0.75...1.5 mm ² , Multiple: 2 x 0.75...1.5 mm ² , Flexible IEC connections	Single: 0.75...1.5 mm ² , Multiple: 2 x 0.75...1.5 mm ² , Stripping length 7.5 mm
Internal resistance R_i	0.0065 Ω	0.0065 Ω
Power loss at rated current P_v	0.24 W	0.24 W
Ambient temperature	Tmax. +55 °C Tmin –25 °C	Tmax. +55 °C Tmin –25 °C
Environmental conditions (damp heat) acc. to IEC/EN 60068-2-30	28 cycles with 55 °C/90...96 % and 25 °C/95...100 %	
Tightening torque	1 Nm	1 Nm

SMISLINE TP plug-in system

Auxiliary switch and signal contacts

MCB S400, RCCB F404, RCCB F402, RCBO FS401



HK400..L



HK400..R



SK400..L



SK400..R

Auxiliary switch

The auxiliary switch and signal contacts are supplied with one contacting piece. The signal contact collective alarm are supplied with two contacting pieces.

for left side mounting on MCB S400, RCCB F402, RCBO FS401, FS403

	Bbn 761227	Order details		Price 1 piece	Weight 1 piece	Pack unit
	EAN	Type code	Order code		kg	pc.
1NO and 1NC	0100910	HK40011-L	2CCS500900R0081		0.045	10
2NO	0111183	HK40020-L	2CCF201112R0001		0.040	10
2NC	0111190	HK40002-L	2CCF201114R0001		0.040	10

for right side mounting on RCCB F404, MCB S400 and IS404

1NO and 1NC	0108619	HK40011-R	2CCS500900R0214		0.045	10
2NO	0111206	HK40020-R	2CCF201113R0001		0.040	10
2NC	0111213	HK40002-R	2CCF201115R0001		0.040	10

Signal contacts

for left side mounting on MCB S400, RCCB F402, RCBO FS401, FS403

	Bbn 761227	Order details		Price 1 piece	Weight 1 piece	Pack unit
	EAN	Type code	Order code		kg	pc.
1NO and 1NC	0100934	SK40011-L	2CCS500900R0101		0.045	10
2NO	0111107	SK40020-L	2CCF201162R0001		0.040	10
2NC	0111114	SK40002-L	2CCF201164R0001		0.040	10

for right side mounting on RCCB F404 and MCB S400

1NO and 1NC	0108626	SK40011-R	2CCS500900R0215		0.045	10
2NO	0111121	SK40020-R	2CCF201163R0001		0.040	10
2NC	0111138	SK40002-R	2CCF201165R0001		0.040	10

Signal contact collective alarm and auxiliary contact

for left side mounting

	Bbn 761227	Order details		Price 1 piece	Weight 1 piece	Pack unit
	EAN	Type code	Order code		kg	pc.
1NO	0107964	SK40010-L SA	2CCS500900R0141		0.045	10
1NO	1407902	HK40010-L SA	2CCF201212R0001		0.045	10

for right side mounting

1NO	0108633	SK40010-R SA	2CCS500900R0216		0.045	10
1NO	1407919	HK40010-R SA	2CCF201213R0001		0.045	10

Collective alarm, signal contact contacts the auxiliary busbars LA, LB

A cost-effective collective alarm solution can be implemented without additional wiring by using this arrangement.



SMISLINE TP plug-in system

Dummy housing, Neutral disconnecter, shunt trip



Dummy housing

Connection support dummy housing

for left or right side mounting on MCB S400, RCCB F402, RCCB F404, RCBO FS401

Connection support	Bbn	Order details		Price	Weight	Pack
	761227			1 piece	1 piece	unit
	EAN	Type code	Order code		kg	pc.
	100958	AS400	2CCS500900R0151		0.045	10

Dummy housing

Compensation to 18mm	0100965	ZLS931	2CCS500900R0161		0.035	10
----------------------	---------	--------	-----------------	--	-------	----



Contacting

Contacting pieces for auxiliary switch and signal contacts

Connection support	Bbn	Order details		Price	Weight	Pack
	761227			1 piece	1 piece	unit
	EAN	Type code	Order code		kg	pc.
Contacting piece for HK/SK LA, LB Pack contains 100 items	0100972	ZLS632	2CCS500900R0171		0.200	Pack contains 100 items
Contacting piece for HK/SK LA, LB Pack contains 10 items	0109265	ZLS635	2CC5201307R0171		0.020	Pack contains 10 items
Contact Pin	0108640	ZLS633	2CCS500900R0201		0.020	Pack contains 10 items

Neutral disconnecter

On the load side terminal two separate conductors can be clamped



Neutral disconnecter

Connection support	Bbn	Order details		Price	Weight	Pack
	761227			1 piece	1 piece	unit
	EAN	Type code	Order code		kg	pc.
Neutral disconnecter 9mm	0100859	NT401 63	2CCS500900R0021		0.045	10
Neutral disconnecter 18mm	0100842	NT402 63	2CCS500900R0011		0.058	10
Compensation to 18mm for NT401 63	0104710	ZLS728	2CCS400900R0101		0.015	1 Bag contains 5 items

Shunt trip

Function: remote opening of the device when a voltage is applied.

Suitable for MCBs S400 series.



S2C-A

Rated voltage	Bbn	Order details		Price	Weight	Pack
	401677			1 piece	1 piece	unit
	EAN	Type code	Order code		kg	pc.
12-60VAC/DC	9570992	S 2C-A1	2CDS200909R0001		0.150	1
110-415VAC/DC, 110-250VDC	9571005	S 2C-A2	2CDS200909R0002		0.150	1

Orders for this two types can be done over DESTO

SMISLINE TP plug-in system

Technical data IEC/EN 61439-6

Busbar system 125 A

Busbar system touch proof:

Use only for wall mounted application (horizontal or vertical). When installed correctly the requirements of IEC/EN 61439-2 are met.

Number of poles	max. 6 to 110 3p+N / 2 additional bars PE+N
Rated operational voltage (U_e)	690 VAC, 440 VDC (400V for LA, LB busbars)
Rated insulation voltage (U_i)	690 VAC, 440 VDC
IP Code	IP20B
Mounting position	horizontal or vertical, direct mounting or mounting on DIN rail acc. to EN 60715 35 mm
Pollution degree	3 (690V a.c.) 2 (1000V d.c.)
Rated impulse voltage (U_{imp})	8 kV Main busbars; 6 KV Auxiliary busbars
Rated current of the assembly (I_n)	Max. 125 A (side feeding) Max. 200 A (center feeding) Max. 250 A (Double feed side or center)
Auxiliary circuit	max. 40 A
Rated current of a circuit (I_{nc})	Main circuit: Max. 125 A
Rated current of Auxiliary circuit	40 A
Rated short-time withstand current (I_{cw})	10 kA / 300 ms
Auxiliary circuit	4 kA / 50 ms
Rated peak withstand current (I_{pk})	Main circuit: 30 kA
Auxiliary circuit	Auxiliary busbars LA, LB 6 kA
Rated frequency (f)	50/60 Hz, DC
Rated conditional short-circuit current (I_{cc})	100 kA (415V), 50 kA (690 V)
Ambient air temperature	max. 60°C
Environmental conditions (damp heat) acc. to IEC/EN 60068-2-30	1 cycle with 55°C/90...96% and 25°C/95...100%
Size of CU bars 3P+N+PE	3x10 mm (30 mm ²)
Size of CU auxiliary bars La Lb	2x5 mm (10 mm ²)
Resistance and reactance values for Busbar ZLS200	R 0.325 mΩ/m X 0.295 mΩ/m

	Maximum rated voltage	Maximum rated current	Cross-section of conductors
Incoming terminal block ZLS250–253	690 VAC 1000 VDC	160 A	35 mm ² –95 mm ² max. 1 wire, 10–25 mm ² 1 or 2 wires
Busbar ZLS200	690 VAC 1000 VDC	125 A	
Busbar ZLS202	690 VAC 600 VDC	40 A	
DIN Rail adapters 32 A	690 VAC 600 VDC	32 A Line or neutral	
DIN Rail adapters 63 A	690 VAC 600 VDC	63 A Line or neutral	
Combi module	690 VAC 600 VDC	32 A Line or neutral 6A LA, LB	

The SMISLINE system and components are tested for vibration according to IEC 60068-2-6 (2–13.2 Hz/1 mm displacement, 13.2–100 Hz/0.7 g) and for Miniature circuit breakers (5 g, 20 frequency cycles 5 ... 150 ... 5 Hz at 0.8 rated current)

Standard: IEC 60068-2-6

Environmental testing – Part 2–6: Test Fc. Vibration (sinusoidal)

Rated Voltage (U_e)	Rated conditional short-circuit current (I_{cc})	Incoming current of main busbars (L1, L2, L3, N)	Short circuit protection device (SCPD)	
			Fuse	MCCB
415 V	100 kA	250 A	NH1 gG 690 V/250 A	ABB T _{max} XT Serie up to 250 A
690 V	25 kA	250 A	NH1 gG 690 V/250 A	ABB T _{max} XT Serie up to 250 A
Incoming current of auxiliary busbars (La, Lb)				
	25 kA	40 A	NH00 gG 415 V/40 A	ABB Type S800 (240/415 VAC)

SMISLINE TP plug-in system

Technical data data UL508; Approvals for US and CA: cULus

Busbar system 125A

SMISLINE TP system for UL 508 – Industrial Control Equipment, CSA C22.2 No. 14 – Industrial Control Equipment UL File E222110

Technical data UL508 Industrial Control Equipment SMISLINE TP busbar system

Rated Voltage	600 VAC
Rated Current	125 A
Rated Current (End Feed, left and right)	125 A left, 125 A right
Rated Current (Center)	250 A max. (double feed)
Rated Current (Center Feed)	250 A max. if used with two feeder blocks
Short Circuit Ratings	50 kA, max. 480 VAC, 480 Y/277 V and 240 VAC or
ABB T _{max} XT2, XT3, XT4	35 kA, max. 600 VAC and 600 Y/347 V

Technical data UL508 Industrial Control Equipment (ZLS906, ZLS908, ZLS920, ZLS926, ZLS928)

	Busbar ZLS200	Feeder ZLS924	Feeder block ZLS95X	Combimodule ZLS840X, 842X	DIN Rail adapter ZLS97X	Terminals ZLS95XUL, 91XUL	Combi modul ZMS132X	Adapter moter strater ZMS93X
Maximum rated voltage	600 VAC	600 VAC	600 VAC	600 VAC	600 VAC	600 VAC	600 VAC	600 VAC
Maximum rated current	125 A	150 A	150 A	30 A	32 A, 63 A	32 A, 100 A, 150 A	32 A	32 A

Terminals for 125A SMISLINE TP System

ZLS954UL – Terminal 150 A (Neutral)

ZLS959UL – Terminal (PE)

ZLS913UL – Terminal 63 A (Neutral)

ZLS918UL – Terminal 32 A (Neutral)

ZLS919UL – Terminal (PE)

ZLS929UL – Terminal (PE)

DIN Rail adapters for MCB SU200 and SUP200

	970UL, 971UL, 972UL or 973UL
Maximum nominal current	25 A, 45 A

SMISLINE TP plug-in system

Starter pack Touch proof 3L – 125 A system

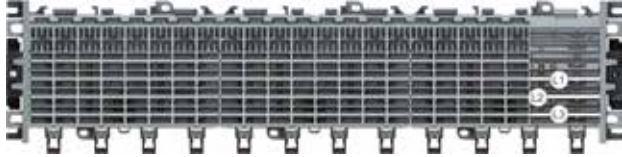

Starter Pack 3L: L1, L2, L3 inclusive socket end piece

Solutions available	Busbars length incl. Socket end piece mm	Busbars length mm	Bbn 761227 EAN	Order details		Price 1 piece	Weight 1 piece kg	Pack unit pc.
				Type code	Order code			
18 PLE 3L	364	320	1426514	ZLS905E18-3L	2CCA183232R0001		0.530	1
20 PLE 3L	401	355	1413231	ZLS905E20-3L	2CCA183100R0001		0.637	1
22 PLE 3L	437	391	1413255	ZLS905E22-3L	2CCA183102R0001		0.693	1
24 PLE 3L	473	427	1413279	ZLS905E24-3L	2CCA183104R0001		0.749	1
26 PLE 3L	509	463	1413293	ZLS905E26-3L	2CCA183106R0001		0.813	1
28 PLE 3L	545	499	1413415	ZLS905E28-3L	2CCA183108R0001		0.848	1
30 PLE 3L	581	535	1413439	ZLS905E30-3L	2CCA183110R0001		0.933	1
32 PLE 3L	617	571	1413453	ZLS905E32-3L	2CCA183112R0001		0.981	1
34 PLE 3L	653	607	1413477	ZLS905E34-3L	2CCA183114R0001		1.044	1
36 PLE 3L	689	643	1413491	ZLS905E36-3L	2CCA183116R0001		1.100	1
38 PLE 3L	725	679	1413514	ZLS905E38-3L	2CCA183118R0001		1.156	1
40 PLE 3L	761	715	1413538	ZLS905E40-3L	2CCA183120R0001		1.212	1
42 PLE 3L	797	751	1413552	ZLS905E42-3L	2CCA183122R0001		1.276	1
44 PLE 3L	833	787	1413576	ZLS905E44-3L	2CCA183124R0001		1.332	1
46 PLE 3L	869	823	1413590	ZLS905E46-3L	2CCA183126R0001		1.388	1
48 PLE 3L	905	859	1413613	ZLS905E48-3L	2CCA183128R0001		1.444	1
50 PLE 3L	941	896	1413637	ZLS905E50-3L	2CCA183130R0001		1.508	1
52 PLE 3L	977	932	1413651	ZLS905E52-3L	2CCA183132R0001		1.564	1
54 PLE 3L	1013	968	1413675	ZLS905E54-3L	2CCA183134R0001		1.620	1
56 PLE 3L	1049	1004	1413699	ZLS905E56-3L	2CCA183136R0001		1.675	1
58 PLE 3L	1058	1040	1413712	ZLS905E58-3L	2CCA183138R0001		1.739	1
60 PLE 3L	1122	1076	1413736	ZLS905E60-3L	2CCA183140R0001		1.795	1
62 PLE 3L	1158	1112	1413750	ZLS905E62-3L	2CCA183142R0001		1.851	1
64 PLE 3L	1194	1148	1413774	ZLS905E64-3L	2CCA183144R0001		1.907	1
66 PLE 3L	1230	1184	1413798	ZLS905E66-3L	2CCA183146R0001		1.971	1
68 PLE 3L	1266	1220	1413811	ZLS905E68-3L	2CCA183148R0001		2.027	1
70 PLE 3L	1302	1256	1413835	ZLS905E70-3L	2CCA183150R0001		2.083	1
72 PLE 3L	1338	1292	1413859	ZLS905E72-3L	2CCA183152R0001		2.139	1
74 PLE 3L	1374	1328	1413873	ZLS905E74-3L	2CCA183154R0001		2.203	1
76 PLE 3L	1410	1364	1413897	ZLS905E76-3L	2CCA183156R0001		2.269	1
78 PLE 3L	1446	1400	1413910	ZLS905E78-3L	2CCA183158R0001		2.314	1
80 PLE 3L	1482	1436	1413934	ZLS905E80-3L	2CCA183160R0001		2.370	1

SMISLINE TP plug-in system

Starter pack Touch proof 3LN – 125 A system

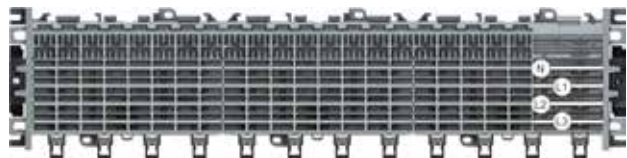

Starter Pack 3LN: L1, L2, L3, N inclusive socket end piece

Solutions available	Busbars length incl. Socket end piece mm	Busbars length mm	Bbn 761227 EAN	Order details		Price 1 piece	Weight 1 piece kg	Pack unit pc.
				Type code	Order code			
18 PLE 3LN	364	320	1426521	ZLS905E18-3LN	2CCA183234R0001		0.615	1
20 PLE 3LN	401	355	1413248	ZLS905E20-3LN	2CCA183101R0001		0.724	1
22 PLE 3LN	437	391	1413262	ZLS905E22-3LN	2CCA183103R0001		0.789	1
24 PLE 3LN	473	427	1413286	ZLS905E24-3LN	2CCA183105R0001		0.800	1
26 PLE 3LN	509	463	1413408	ZLS905E26-3LN	2CCA183107R0001		0.926	1
28 PLE 3LN	545	499	1413422	ZLS905E28-3LN	2CCA183109R0001		0.970	1
30 PLE 3LN	581	535	1413446	ZLS905E30-3LN	2CCA183111R0001		1.046	1
32 PLE 3LN	617	571	1413460	ZLS905E32-3LN	2CCA183113R0001		1.120	1
34 PLE 3LN	653	607	1413484	ZLS905E34-3LN	2CCA183115R0001		1.193	1
36 PLE 3LN	689	643	1413507	ZLS905E36-3LN	2CCA183117R0001		1.2.57	1
38 PLE 3LN	725	679	1413521	ZLS905E38-3LN	2CCA183119R0001		1.322	1
40 PLE 3LN	761	715	1413545	ZLS905E40-3LN	2CCA183121R0001		1.387	1
42 PLE 3LN	797	751	1413569	ZLS905E42-3LN	2CCA183123R0001		1.459	1
44 PLE 3LN	833	787	1413583	ZLS905E44-3LN	2CCA183125R0001		1.524	1
46 PLE 3LN	869	823	1413606	ZLS905E46-3LN	2CCA183127R0001		1.589	1
48 PLE 3LN	905	859	1413620	ZLS905E48-3LN	2CCA183129R0001		1.653	1
50 PLE 3LN	941	896	1413644	ZLS905E50-3LN	2CCA183131R0001		1.726	1
52 PLE 3LN	977	932	1413668	ZLS905E52-3LN	2CCA183133R0001		1.791	1
54 PLE 3LN	1013	968	1413682	ZLS905E54-3LN	2CCA183135R0001		1.855	1
56 PLE 3LN	1049	1004	1413705	ZLS905E56-3LN	2CCA183137R0001		1.920	1
58 PLE 3LN	1058	1040	1413729	ZLS905E58-3LN	2CCA183139R0001		1.992	1
60 PLE 3LN	1122	1076	1413743	ZLS905E60-3LN	2CCA183141R0001		2.057	1
62 PLE 3LN	1158	1112	1413767	ZLS905E62-3LN	2CCA183143R0001		2.122	1
64 PLE 3LN	1194	1148	1413781	ZLS905E64-3LN	2CCA183145R0001		2.186	1
66 PLE 3LN	1230	1184	1413804	ZLS905E66-3LN	2CCA183147R0001		2.259	1
68 PLE 3LN	1266	1220	1413828	ZLS905E68-3LN	2CCA183149R0001		2.324	1
70 PLE 3LN	1302	1256	1413842	ZLS905E70-3LN	2CCA183151R0001		2.388	1
72 PLE 3LN	1338	1292	1413866	ZLS905E72-3LN	2CCA183153R0001		2.453	1
74 PLE 3LN	1374	1328	1413880	ZLS905E74-3LN	2CCA183155R0001		2.526	1
76 PLE 3LN	1410	1364	1413903	ZLS905E76-3LN	2CCA183157R0001		2.590	1
78 PLE 3LN	1446	1400	1413927	ZLS905E78-3LN	2CCA183159R0001		2.655	1
80 PLE 3LN	1482	1436	1413941	ZLS905E80-3LN	2CCA183161R0001		2.719	1

SMISLINE TP plug-in system

Starter pack Touch proof 3L LA LB – 125A system



Starter Pack 3LLALB: L1, L2, L3, LA, LB inclusive socket end piece

Solutions available	Busbars length incl. Socket end piece mm	Busbars length mm	Bbn 761227 EAN	Order details		Price 1 piece	Weight 1 piece kg	Pack unit pc.
				Type code	Order code			
18 PLE 3L LA LB	364	320	1426538	ZLS905E18-3LLALB	2CCA183233R0001	0.586	1	
20 PLE 3L LA LB	401	355	1416904	ZLS905E20-3LLALB	2CCA183162R0001	0.753	1	
22 PLE 3L LA LB	437	391	1416911	ZLS905E22-3LLALB	2CCA183164R0001	0.821	1	
24 PLE 3L LA LB	473	427	1416928	ZLS905E24-3LLALB	2CCA183166R0001	0.835	1	
26 PLE 3L LA LB	509	463	1416935	ZLS905E26-3LLALB	2CCA183168R0001	0.964	1	
28 PLE 3L LA LB	545	499	1416942	ZLS905E28-3LLALB	2CCA183170R0001	1.011	1	
30 PLE 3L LA LB	581	535	1416959	ZLS905E30-3LLALB	2CCA183172R0001	1.107	1	
32 PLE 3L LA LB	617	571	1416966	ZLS905E32-3LLALB	2CCA183174R0001	1.167	1	
34 PLE 3L LA LB	653	607	1416973	ZLS905E34-3LLALB	2CCA183176R0001	1.242	1	
36 PLE 3L LA LB	689	643	1416980	ZLS905E36-3LLALB	2CCA183178R0001	1.310	1	
38 PLE 3L LA LB	725	679	1416997	ZLS905E38-3LLALB	2CCA183180R0001	1.377	1	
40 PLE 3L LA LB	761	715	1417000	ZLS905E40-3LLALB	2CCA183182R0001	1.445	1	
42 PLE 3L LA LB	797	751	1417017	ZLS905E42-3LLALB	2CCA183184R0001	1.520	1	
44 PLE 3L LA LB	833	787	1417024	ZLS905E44-3LLALB	2CCA183186R0001	1.588	1	
46 PLE 3L LA LB	869	823	1417031	ZLS905E46-3LLALB	2CCA183188R0001	1.656	1	
48 PLE 3L LA LB	905	859	1417048	ZLS905E48-3LLALB	2CCA183190R0001	1.723	1	
50 PLE 3L LA LB	941	896	1417055	ZLS905E50-3LLALB	2CCA183192R0001	1.799	1	
52 PLE 3L LA LB	977	932	1417062	ZLS905E52-3LLALB	2CCA183194R0001	1.866	1	
54 PLE 3L LA LB	1013	968	1417079	ZLS905E54-3LLALB	2CCA183196R0001	1.934	1	
56 PLE 3L LA LB	1049	1004	1417086	ZLS905E56-3LLALB	2CCA183198R0001	2.001	1	
58 PLE 3L LA LB	1058	1040	1417093	ZLS905E58-3LLALB	2CCA183200R0001	2.077	1	
60 PLE 3L LA LB	1122	1076	1417109	ZLS905E60-3LLALB	2CCA183202R0001	2.144	1	
62 PLE 3L LA LB	1158	1112	1417116	ZLS905E62-3LLALB	2CCA183204R0001	2.212	1	
64 PLE 3L LA LB	1194	1148	1417123	ZLS905E64-3LLALB	2CCA183206R0001	2.279	1	
66 PLE 3L LA LB	1230	1184	1417130	ZLS905E66-3LLALB	2CCA183208R0001	2.355	1	
68 PLE 3L LA LB	1266	1220	1417147	ZLS905E68-3LLALB	2CCA183210R0001	2.423	1	
70 PLE 3L LA LB	1302	1256	1417154	ZLS905E70-3LLALB	2CCA183212R0001	2.490	1	
72 PLE 3L LA LB	1338	1292	1417161	ZLS905E72-3LLALB	2CCA183214R0001	2.558	1	
74 PLE 3L LA LB	1374	1328	1417178	ZLS905E74-3LLALB	2CCA183216R0001	2.633	1	
76 PLE 3L LA LB	1410	1364	1417185	ZLS905E76-3LLALB	2CCA183218R0001	2.701	1	
78 PLE 3L LA LB	1446	1400	1417192	ZLS905E78-3LLALB	2CCA183220R0001	2.768	1	
80 PLE 3L LA LB	1482	1436	1417208	ZLS905E80-3LLALB	2CCA183222R0001	2.836	1	

SMISLINE TP plug-in system

Starter pack Touch proof 3LN LA LB – 125 A system

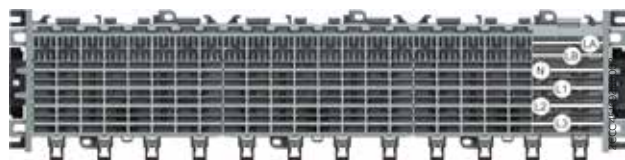

Starter Pack 3LNLALB: L1, L2, L3, N, LA, LB inclusive socket end piece

Solutions available	Busbars length incl. Socket end piece mm	Busbars length mm	Bbn 761227 EAN	Order details		Price 1 piece	Weight 1 piece kg	Pack unit pc.
				Type code	Order code			
18 PLE 3LN LA LB	364	320	1426545	ZLS905E18-3LNLALB	2CCA183235R0001		0.671	1
20 PLE 3LN LA LB	401	355	1417215	ZLS905E20-3LNLALB	2CCA183163R0001		0.841	1
22 PLE 3LN LA LB	437	391	1417222	ZLS905E22-3LNLALB	2CCA183165R0001		0.917	1
24 PLE 3LN LA LB	473	427	1417239	ZLS905E24-3LNLALB	2CCA183167R0001		0.939	1
26 PLE 3LN LA LB	509	463	1417246	ZLS905E26-3LNLALB	2CCA183169R0001		1.078	1
28 PLE 3LN LA LB	545	499	1417253	ZLS905E28-3LNLALB	2CCA183171R0001		1.133	1
30 PLE 3LN LA LB	581	535	1417260	ZLS905E30-3LNLALB	2CCA183173R0001		1.238	1
32 PLE 3LN LA LB	617	571	1417277	ZLS905E32-3LNLALB	2CCA183175R0001		1.306	1
34 PLE 3LN LA LB	653	607	1417284	ZLS905E34-3LNLALB	2CCA183177R0001		1.391	1
36 PLE 3LN LA LB	689	643	1417291	ZLS905E36-3LNLALB	2CCA183179R0001		1.467	1
38 PLE 3LN LA LB	725	679	1417307	ZLS905E38-3LNLALB	2CCA183181R0001		1.543	1
40 PLE 3LN LA LB	761	715	1417314	ZLS905E40-3LNLALB	2CCA183183R0001		1.619	1
42 PLE 3LN LA LB	797	751	1417321	ZLS905E42-3LNLALB	2CCA183185R0001		1.704	1
44 PLE 3LN LA LB	833	787	1417338	ZLS905E44-3LNLALB	2CCA183187R0001		1.780	1
46 PLE 3LN LA LB	869	823	1417345	ZLS905E46-3LNLALB	2CCA183189R0001		1.856	1
48 PLE 3LN LA LB	905	859	1417352	ZLS905E48-3LNLALB	2CCA183191R0001		1.933	1
50 PLE 3LN LA LB	941	896	1417369	ZLS905E50-3LNLALB	2CCA183193R0001		2.017	1
52 PLE 3LN LA LB	977	932	1417376	ZLS905E52-3LNLALB	2CCA183195R0001		2.093	1
54 PLE 3LN LA LB	1013	968	1417383	ZLS905E54-3LNLALB	2CCA183197R0001		2.169	1
56 PLE 3LN LA LB	1049	1004	1417390	ZLS905E56-3LNLALB	2CCA183199R0001		2.246	1
58 PLE 3LN LA LB	1058	1040	1417406	ZLS905E58-3LNLALB	2CCA183201R0001		2.330	1
60 PLE 3LN LA LB	1122	1076	1417413	ZLS905E60-3LNLALB	2CCA183203R0001		2.406	1
62 PLE 3LN LA LB	1158	1112	1417505	ZLS905E62-3LNLALB	2CCA183205R0001		2.482	1
64 PLE 3LN LA LB	1194	1148	1419172	ZLS905E64-3LNLALB	2CCA183207R0001		2.559	1
66 PLE 3LN LA LB	1230	1184	1417420	ZLS905E66-3LNLALB	2CCA183209R0001		2.643	1
68 PLE 3LN LA LB	1266	1220	1417437	ZLS905E68-3LNLALB	2CCA183211R0001		2.719	1
70 PLE 3LN LA LB	1302	1256	1417444	ZLS905E70-3LNLALB	2CCA183213R0001		2.796	1
72 PLE 3LN LA LB	1338	1292	1417451	ZLS905E72-3LNLALB	2CCA183215R0001		2.872	1
74 PLE 3LN LA LB	1374	1328	1417468	ZLS905E74-3LNLALB	2CCA183217R0001		2.956	1
76 PLE 3LN LA LB	1410	1364	1417475	ZLS905E76-3LNLALB	2CCA183219R0001		3.032	1
78 PLE 3LN LA LB	1446	1400	1417482	ZLS905E78-3LNLALB	2CCA183221R0001		3.109	1
80 PLE 3LN LA LB	1482	1436	1417499	ZLS905E80-3LNLALB	2CCA183223R0001		3.185	1

SMISLINE TP plug-in system

Socket

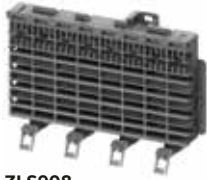

ZLS908



ZLS906

Socket bases ZLS906, ZLS908

The SMISLINE socket system is a totally new kind of assembly and connection technology for the construction of distributions. Besides the classic method of snapping the devices onto 35-mm mounting rails, the new family of devices can be directly attached to the socket bases with integrated busbars. The time-consuming process of connecting up the supply is thereby no longer needed. In addition, in the event of rearrangement or expansion, the replacement of devices in existing systems is made significantly easier.

The socket sections and the wide range of accessories make it possible to plan with the capability for expansion and to construct distribution systems of any desired size in a short period of time.

6- and 8-module sockets are installed either by screwing them onto any flat surface or by snapping them onto a 35 mm DIN mounting rail. Lateral movement or detachment of the sockets again is possible before final fixing.

In order to determine the required socket length, the space necessary for

- the devices required
- the incoming terminal block and
- any reserve spaces needed must be determined.

Snap mounting

Pull down the slide with a screwdriver until it latches (socket can be moved).

Press on front of slid:

Fixed position

(Sockets fixed)

The key features

- System of any desired length (even number of poles)
- Integrated busbars
- Simple device change
- Long-term planning and problem free extension possible
- Significant time savings during assembly and connection

Socket base

Description/ application	Bbn 761227	Order details		Price 1 piece	Weight 1 piece	Pack unit
	EAN	Type code	Order code		kg	pc.
8-module socket Length 144 mm (includes base and cover)	1413965	ZLS908	2CCA183030R0001		0.092	10
6-module socket Length 108 mm (includes base and cover)	1413958	ZLS906	2CCA183035R0001		0.071	10

Busbars for the sockets and additional socket ZLS200

The busbars of size 10x3 mm can be loaded with currents up to 125A. They are plated for perfect contact with the devices plug-in contacts. The maximum available busbar length is

SMISLINE TP plug-in system

Busbars, Socket end piece – 125 A system



ZLS20x

1979 mm. The same busbar type is used, regardless whether it is fitted in the socket (L1, L2, L3, N) or in the additional socket (N, PE). The busbars are inserted in to the socket from the front.

Auxiliary busbars for the socket ZLS202

The 5x2 mm auxiliary busbars are intended for a common power supply of auxiliary switches and signal contacts. They are also plated and their max. delivery length is 1979 mm.

Like the main busbars, the auxiliary busbars are inserted in holders LA and LB from the front. Of course, only on auxiliary busbar can be fitted.

Busbars for the sockets

Description/ application	Bbn 761227	Order details		Price 1 piece	Weight 1 piece	Pack unit
	EAN	Type code	Order code		kg	pc.
125A busbar plated, 10x3 mm, for L1, L2, L3, N and PE – Delivery length 1979 mm	0015702	ZLS200	2CCF002772R0001		0.640	10
40A auxiliary busbar plated, 5x2 mm, for LA und LB – Delivery length 1979 mm	0015719	ZLS202	2CCF002773R0001		0.240	10

Socket end piece ZLS920

To prevent displacement of sockets and busbars (particularly when installed vertically) end pieces can be fitted at the start and finish of each row of sockets. These simultaneously ensure electrically protected covering of the busbar end faces and mechanical fixing of the sockets on the mounting rail.



ZLS920

Socket end piece

Description/ application	Bbn 761227	Order details		Price 1 piece	Weight 1 piece	Pack unit
	EAN	Type code	Order code		kg	pc.
To prevent displacement of sockets and busbars	1415617	ZLS920	2CCA183017R0001		0.060	1

Incoming devices and terminals

Technical data IEC/EN 61439-6 and UL508

Incoming blocks

	ZLS26X	ZLS924	ZLS25X,95X
General data			
Standards	IEC/EN 61439-6	IEC/EN 61439-6, UL508	IEC/EN 61439-6, UL508
Rated voltage U_n acc. IEC	690 VAC, 1000 VDC	690 VAC, 1000 VDC	690 VAC, 1000 VDC
Rated Voltage acc. UL		600 VAC	600 VAC
Rated current I_n acc. IEC	63 A	160 A	200 A
Rated current I_n acc. UL		150 A	200 A
Rated conditional short-circuit current (I_{cc})	100 kA (415V)		
Installation			
Terminal rigid IEC connections (solid/stranded)	2,5 mm ² to 25 mm ² max. 1 wire	100 kA (415V) 10 mm ² up to 50 mm ² (3LN) 1.5 mm ² up to 10 mm ² (LA, LB) Multiple 3LN: – Multiple LA, LB: –	100 kA (415V) 10 mm ² to 95 mm ²
Terminal flexible IEC connections	2,5 mm ² to 25 mm ² max. 1 wire flexible wire with ferrules	10 mm ² up to 50 mm ² single wire 1.5 mm ² up to 10 mm ² (LA, LB) single wire 2x25 mm ² cable with the same type and size Multiple LA, LB: –	10 mm ² to 95 mm ² flexible wire with ferrules
Other connections		Flat cable 9x2x0,8 up to 9x9x0,8 mm and 10x3 mm Busbar 10x3 mm combined with 10 mm ² up to 25 mm ² rigid or flexible IEC connections	10 mm ² to 95 mm ²
Terminal rigid UL connections		Single: 8 up to 1/0 AWG, Cu only Multiple: –	2 AWG – 1/0 AWG
Torque	2.8 Nm	4.0 Nm (L,N); 1.5 Nm (LA, LB); 1.2 Nm Cover screw	2.0 Nm
Stripping length	13 mm	18 mm (L,N); 11 Nm (LA, LB)	21 mm

SMISLINE TP plug-in system

Incoming terminal block and components – 125A system



ZLS26x



ZLS25x



ZLS95x

Incoming terminal blocks ZLS260 to 262

Compact terminal block with the construction width of 18 mm for 2 poles. The maximum rated current is 63 A for L1, L2, L3N and 6 A for LA, LB.

Incoming terminal block 18 mm, 63 A 2,5 mm² to 25 mm² max. 1 wire

1 contact above 1 contact bottom

Version	Bbn 761227	Order details		Price 1 piece	Weight 1 piece	Pack unit
	EAN	Type code	Order code		kg	pc.
L1, L3 63 A	0111572	ZLS260	2CCA205305R0001		0.090	1
L2, N 63 A	0111589	ZLS261	2CCA205306R0001		0.090	1
LA, LB 6 A	0111596	ZLS262	2CCA205307R0001		0.090	1

Incoming terminal component ZLS250-253; 954, 955

The incoming terminal component, with an installation width of 36 mm is available as a single-pole component for the line conductors L1, L2, L3 and as neutral. The terminals act directly on the busbars and thereby fix the incoming terminal component. The incoming terminal component, L1, L2, L3 and N can be combined to meet specific needs. A maximum cable cross-section of 95 mm² can be connected to the incoming terminal component.

Incoming terminal component 10 mm² to 95 mm² max. 1 wire

Version	Bbn 761227	Order details		Price 1 piece	Weight 1 piece	Pack unit
	EAN	Type code	Order code		kg	pc.
Feeder component L1	0505319	ZLS251	2CCV672501R0001		0.120	1
Feeder component L2	0505326	ZLS252	2CCV672502R0001		0.120	1
Feeder component L3	0505333	ZLS253	2CCV672503R0001		0.120	1
Feeder component N	0505340	ZLS250	2CCV672500R0001		0.120	1
Feeder component N additional socket	1424404	ZLS954	2CCV672508R0001		0.088	1
Feeder component PE additional socket	1487164	ZLS959	2CCA672510R0001		0.088	1
Feeder component N additional socket (2 holes)	1515348	ZLS954-1	2CCG001032R0001		0.088	1

SMISLINE TP plug-in system

Incoming terminal block and components – 125 A system



General

The incoming terminal block is used to connect cables directly to the busbars. The terminals act directly on the busbars and therefore fix the incoming terminal block. Removable terminal tops permit the connection of continuous conductors (risers) while horizontal or vertical cable entry is also possible.

Instead of using the incoming terminal block, the power supply can also be realized via a device (e.g. residual current operated circuit breaker, miniature circuit breaker or switch disconnector).

Power supply left or right, maximum 125 A.



Power supply in centre, maximum 160 A.

A maximum of 125 A is permitted on either side. A total of 160 A shall not be exceeded.



Left Version ZLS924 --L

Right Version ZLS924 --R

Terminals of the left and right version of the Incoming block are turned. Because of this there is no cable cross by connecting two SMISLINE rows (see picture)

Incoming terminal blocks ZLS924

A standard incoming terminal block whose cover provides protection against accidental contact. Construction height 50 mm. The base plate can be fitted with a maximum of 4 main terminals L1, L2, L3 and N for the busbars, and 2 auxiliary terminals LA and LB for the auxiliary busbars.

SMISLINE TP plug-in system

Incoming terminal block and components



Incoming terminal blocks 6 mm² to 50 mm² (2 × 25 mm²) + 2 × 10 mm² (LA, LB)

Version	Module	Bbn 761227	Order details		Price 1 piece	Weight 1 piece	Pack unit
		EAN	Type code	Order code		kg	pc.
50 mm ² (2×25 mm ²) 4 3L left	4	1503086	ZLS924-3L	2CCF181816R0001		0.140	1
50 mm ² (2×25 mm ²) 4 3L+N left	4	1503093	ZLS924-3LN	2CCF181818R0001		0.168	1
50 mm ² (2×25 mm ²) 4 3L+N+LA+LB left	4	1503109	ZLS924-3LNAB	2CCF181820R0001		0.188	1
50 mm ² (2×25 mm ²) 4 3L right	4	1503116	ZLS924-3L-R	2CCF181817R0001		0.140	1
50 mm ² (2×25 mm ²) 4 3L+N right	4	1503123	ZLS924-3LN-R	2CCF181819R0001		0.168	1
50 mm ² (2×25 mm ²) 4 3L+N+LA+LB right	4	1503130	ZLS924-3LNAB-R	2CCF181821R0001		0.188	1

Terminals for incoming block

Version	Module	Bbn 761227	Order details		Price 1 piece	Weight 1 piece	Pack unit
		EAN	Type code	Order code		kg	pc.
Terminal L	-	1503147	ZLS936	2CCF181805R0001		0.028	1
Terminal LA LB	-	1503154	ZLS937	2CCF181807R0001		0.010	1

Cover for incoming terminal block

Version	Module	Bbn 761227	Order details		Price 1 piece	Weight 1 piece	Pack unit
		EAN	Type code	Order code		kg	pc.
4		1503161	ZLS939	2CCF181812R0001		0.026	1

SMISLINE TP plug-in system

Terminals for additional socket – 125A system



ZLS928

Additional socket

The additional socket can easily be fitted onto the socket base to accommodate the external N and/or PE busbars. This enables neutral connections to be made where single-pole miniature circuit breakers are used with unswitched neutral. Neutral terminals are clipped onto the additional socket and can be used as detachable neutral connections. One N busbar and/or one PE busbar can be fitted. Each socket base can be equipped with an additional socket. Because it contains an integrated 35 mm DIN-rail snap-on feature, the external N or PE busbars can be fitted anywhere in the distribution panel, even separately from the system. The additional sockets can be covered to prevent accidental contact with live parts.



ZLS926

Additional socket for external N and PE busbars

Description/ application	Bbn 761227	Order details		Price 1 piece	Weight 1 piece	Pack unit
		EAN	Type code			
8-module socket (suitable for 8-module socket)	1420444	ZLS928	2CCA183630R0001		0.034	10
6-module socket (suitable for 6-module socket)	1420437	ZLS926	2CCA183635R0001		0.026	10

Incoming terminals

Technical data IEC/EN 61439-6 and UL508

Terminals

	10mm ² IEC ZLS918, ZLS919	10mm ² UL ZLS918UL, ZLS919UL	35mm ² IEC ZLS913, ZLS916, ZLS929	35mm ² UL ZLS913UL, ZLS929UL	95mm ² IEC ZLS954, ZLS959	95mm ² UL ZLS954UL, ZLS959UL
General data						
Standards	IEC/EN 61439-6	UL 508 CSA C22.2 No. 14-13	IEC/EN 61439-6	UL 508 CSA C22.2 No. 14-13	IEC/EN 61439-6	UL 508 CSA C22.2 No. 14-13
Rated voltage U _e acc. IEC	690 VAC, 1000 VDC	–	690 VAC, 1000 VDC	–	690 VAC, 1000 VDC	–
Rated voltage acc. UL–	–	600 VAC	–	600 VAC	–	600 VAC
Rated current I _n acc. IEC	32 A	–	63 A	–	200 A	–
Rated current acc. UL–	–	32 A	–	63 A	–	150 A
Installation						
Terminal rigid IEC connections (solid/stranded)	Single: 1 ... 10 mm ² Multiple: 2 x 1.5 ... 2.5 mm ² , with cables of same type and size	–	–	–	–	–
Terminal flexible IEC connections	Single: 0.7 ... 10 mm ² Multiple: 2 x 1.5 ... 2.5 mm ² , with cables of same type and size	–	Single: 16 ... 35 mm ² Multiple: –	–	Single: 10 ... 95 mm ² Multiple: 2 x 10 ... 25 mm ² , with cables of same type and size	–
Terminal UL connections	–	Single: 14 ... 8 AWG Multiple: –	–	Single: 6 ... 2 AWG Multiple: –	–	Single: 2 ... 1/0 AWG Multiple: –
Torque	1.2 Nm	1.2 Nm	2.5 Nm	2.5 Nm	2.0 Nm	2.0 Nm
Stripping length:	12 mm	12 mm	15 mm	15 mm	21 mm	21 mm

SMISLINE TP plug-in system

Terminals TP, additional socket (use for ZLS926/928 and ZLSP926/926)

N terminals and PE terminals

Corresponding N terminals (blue) or PE terminals (yellow-green) are available for the power supply and the outgoing conductors of the external N and PE busbars for cross sections. The terminals are fitted with label holders which can be used with the marking adapter or the self-adhesive marking label (Phoenix Contact type Cipline UC-TM):

Connection for the terminals

ZLS918, 919	0.75 mm ² up to 10 mm ² litz wire with ferrule 1 mm ² up to 10 mm ² strand 2x1.5 mm ² or 2x2.5 mm ² allowed, all other combinations it is only allowed with one wire
ZLS913, 929	16 mm ² up to 35 mm ² wire with ferrule, max. 1 wire
ZLS954, 959	50 mm ² up to 95 mm ² wire with ferrule, max. 1 wire

N terminal for additional socket light blue, for external busbars

Description/ application	Bbn 761227	Order details		Price 1 piece	Weight 1 piece	Pack unit
	EAN	Type code	Order code		kg	pc.
N 10 mm ²	1487027	ZLS918	2CCA183440R0001		0.012	Set à 10
N 35 mm ²	1421304	ZLS913	2CCA183470R0001		0.030	10
N 95 mm ²	1424404	ZLS954	2CCV672508R0001		0.100	1
N 95 mm ² two holes	1515348	ZLS954-1	2CCG001032R0001		0.100	1



IEC N terminal



IEC PE terminal

PE terminal for additional socket yellow-green, for external busbars

Description/ application	Bbn 761227	Order details		Price 1 piece	Weight 1 piece	Pack unit
	EAN	Type code	Order code		kg	pc.
PE 10 mm ²	1487041	ZLS919	2CCA183441R0001		0.012	Set à 10
PE 35 mm ²	1486921	ZLS929	2CCA183387R0001		0.030	10
PE 95 mm ²	1487164	ZLS959	2CCA672510R0001		0.100	1

Red/orange terminals for additional socket

Description/ application	Bbn 761227	Order details		Price 1 piece	Weight 1 piece	Pack unit
	EAN	Type code	Order code		kg	pc.
10 mm ²	1487089	ZLS918/Red	2CCA183443R0001		0.012	10
10 mm ²	1487102	ZLS919/Orange	2CCA183444R0001		0.012	10
35 mm ²	1421342	ZLS913/Red	2CCA183465R0001		0.030	10
35 mm ²	1421366	ZLS916/Orange	2CCA183466R0001		0.030	10



d.c.terminals

Insulator block

The dark grey insulator block isolates the interrupted bus bar ends from one another and simultaneously marks the disconnection point externally.

Description/ application	Bbn 761227	Order details		Price 1 piece	Weight 1 piece	Pack unit
	EAN	Type code	Order code		kg	pc.
	1487065	ZLS927	2CCA183442R0001		0.006	10



Isolator

SMISLINE TP plug-in system

Terminal range UL (use for 125A system ZLS926/928)

Connection for the terminals

ZLS918UL, 919UL 0.75 mm² up to 10 mm² litz wire with ferrule 1 mm² up to 10 mm² strand 2x1.5 mm² or 2x2.5 mm² allowed, all other combinatins it is only allowed with one wire

ZLS913UL, 929UL 16 mm² up to 35 mm² wire with ferrule, max. 1 wire

ZLS954UL, 959UL 50 mm² up to 95 mm² wire with ferrule, max. 1 wire

Terminal range UL for additional socket or the 125A system (use on ZLS926/928).

The 250A additional (ZLSP926 and ZLSP928) socket has no UL approbation.

The use for this terminals is only for the 125A system.

N terminal for additional socket light grey, for external busbars

Description/ application	Bbn 761227	Order details		Module	Weight 1 piece	Pack unit
		EAN	Type code			
N 10 mm ² max. 8AWG	1493301	ZLS918UL	2CCA183446R0001	0.5	0.011	1
N 35 mm ² max. 2AWG	1486945	ZLS913UL	2CCA183398R0001	1	0.030	1
N 95 mm ² max. 1/0AWG	1487188	ZLS954UL	2CCA672511R0001	2	0.088	1



UL N terminal

PE terminal for additional socket grey-green, for external busbars

Description/ application	Bbn 761227	Order details		Module	Weight 1 piece	Pack unit
		EAN	Type code			
PE 10 mm ² max. 8AWG	1487140	ZLS919UL	2CCA183447R0001	0.5	0.011	1
PE 35 mm ² max. 2AWG	1486969	ZLS929UL	2CCA183399R0001	1	0.030	1
PE 95 mm ² max. 1/0AWG	1487201	ZLS959UL	2CCA672512R0001	2	0.088	1



UL PE terminal

Insulator block

The dark grey insulator block isolates the interrupted bus bar ends from one another and simultaneously marks the disconnection point externally.

Description/ application	Bbn 761227	Order details		Module	Weight 1 piece	Pack unit
		EAN	Type code			
dark gray, to isolate the N bus bar on the additional socket	1487065	ZLS927	2CCA183442R0001	0.5	0.009	1



Isolator

SMISLINE TP plug-in system

Socket accessories



Dummy housing



Insulator

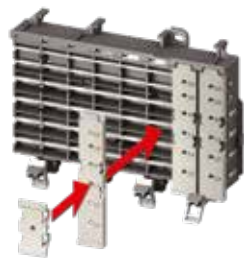

Cover

Intermediate piece ZLS725

The light grey intermediate piece matches the device profile and fills empty module spaces. The busbars are safely covered, so that they cannot be touched and at the same time the corresponding openings in the cover are closed up.

Intermediate piece

Description/ application	Bbn 761227	Order details		Price 1 piece	Weight 1 piece	Pack unit
	EAN	Type code	Order code		kg	pc.
light grey, fills shock-proof empty module spaces 18 mm – bag containing 5 items	0100989	ZLS725	2CCS500900R0181		0.100	1
Compensation piece to 18 mm for NT 9 mm – bag containing 5 items	0104710	ZLS728	2CCS400900R0101		0.070	1

Busbar insulator ZLS938

The dark grey busbar insulator electrically isolates the separated busbar ends from each other (e.g. when using several RCD protected groups) and also identifies the isolation point from outside. It conforms with the device profile and it requires 1 module space.

Busbar insulator

dark grey, for isolation and spacing of separate busbar sections, 18 mm	1418205	ZLS938	2CCA205611R0001		0.001	1
---	---------	--------	-----------------	--	-------	---

Busbar cover ZLS100

If component modules or spare modules are not required, the busbar cover ensures electrically protected covering of the main and auxiliary busbars. The cover (4 modules) can be cut anywhere. The openings allow voltage measurements on the busbars without removing the cover.

Busbar cover

electrically protected covering of main and auxiliary busbars. The 4 modules cover can be divided. Suitable to accept extension adapter ZLS 101 4x18 mm – bag containing 5 items	0015603	ZLS100	2CCF002762R0001		0.095	1
---	---------	--------	-----------------	--	-------	---

Extension adapter ZLS101

The extension adapter, single or several side by side, can be plugged into the busbar cover via the built-in holding device. This enables conventional DIN devices with 45 mm cap size to be snapped onto the SMISLINE socket. By plugging in several extension adapters one on top of the other, heights can be adjusted in multiples of 7 mm

Add-on adapter

18 mm wide, can be plugged on busbar cover ZLS100. To mount conventional DIN devices with 45m cap size. – bag containing 10 items	0015610	ZLS101	2CCF002763R0001		0.002	10
---	---------	--------	-----------------	--	-------	----

SMISSLINE TP plug-in system

Combi modules adapter for manual motor starter and DIN adapters

Technical data IEC/EN 61439-6 and UL508

	ZMS132 Combi Module	ZMS 930 Adapter	ZLS970 DIN Adapter IEC	ZLS970UL DIN Adapter UL489
Standards	IEC/EN 61439-6, UL508	IEC/EN 61439-6, UL508	IEC/EN 61439-6, UL508	UL489 (USL, CNL - Circuit Breaker Accessory)
Rated voltage Ue acc. IEC acc. IEC	690 VAC, 440 V DC	690 VAC, 440 V DC	690 VAC, 440 V DC	
Rated Voltage acc. UL	600 V AC	600 V AC	600 V AC	240 V AC
Rated current In acc.. IEC	32A	32A	32A, 63A Maximum rated current of outgoing circuits (Inc) max. 50 A for S800 with ZLS972X, ZLS973X.	
Rated current In acc. UL	30A	30A	30A, 60A	25A, 45A

SMISLINE TP plug-in system

Combi module 32 A (IN), 6 A (IA, IB)

MS116/132 + AF contactor

Combi module for manual motor starter plus adapter plus contactor

	Description/ application	Bbn 761227 EAN	Type code	Aborder code	Pack unit	Module	Weight 1 piece
Combi module for wires top feed	L1,L2,L3	1414641	ZMS132-3L	2CCA182500R0001	1	2.5	0.095
	L1,L2,L3,LA	1414634	ZMS132-3LA	2CCA182502R0001	1	2.5	0.098
	L1,L2,L3,LB	1414627	ZMS132-3LB	2CCA182504R0001	1	2.5	0.098
	L1, L2,L3, LA, LB	1414610	ZMS132-3LAB	2CCA182506R0001	1	2.5	0.102
Modules for wire bottom feed	L1,L2,L3	1503208	ZMS132-3LWB	2CCF182543R0001	1	2.5	0.105
Module for manual motor starter MS132 K Push-in terminals wires top feed	L1, L2, L3	1503178	ZMS132-3L-PI	2CCF182540R0001	1	2.5	0.105
	L1, L2, L2, LB	1503185	ZMS132-3LB-PI	2CCF182541R0001	1	2.5	0.118
	L1, L2, L2, LA, LB	1503192	ZMS132-3LAB-PI	2CCF182542R0001	1	2.5	0.136
Module without wires, Spare parts	Combi module without wires	1414603	ZMS137	2CCA182508R0001	1	2.5	0.075
	Intermediate piece 9mm	1414412	ZMS935	2CCA182616R0001	1	2.5	0.007
	Connection pin to mount 2 combi modules together	1414801	E210-SPV	2CCC703715R0001	Set of 30 pces		0.01



Combi module



Combi module push in

SMISLINE TP plug-in system

Adapter for manual motor starter

Adapter for manual motor starter plus adapter plus contactor

Adapter for MS116 and MS132 wire bottom feed	EAN number 761227	Type code	Aborder code	Pack unit	Module	Weight 1 piece
L1, L2, L3	1414597	ZMS930	2CCA182520R0001	1	2.5	0.053
L1, L2, L3, LA, LB	1414580	ZMS931	2CCA182522R0001	1	2.5	0.062
L1,L2,L,3,LA	1424619	ZMS936	2CCA182521R0001	1	2.5	0.058
Adapter for MS116 and MS132 wires top feed						
L1, L2, L3	1414573	ZMS932	2CCA182524R0001	1	2.5	0.053
L1, L2, L3, LA, LB	1414566	ZMS933	2CCA182526R0001	1	2.5	0.062
L1,L2,L3,LA	1424626	ZMS937	2CCA182525R0001	1	2.5	0.058
Adapter for manual motor starter MS132 K Push-in terminals wires						
L1,L2,L3 wires bottom	1503215	ZMS930-PI	2CCF182550R0001	1	2.5	0.058
L1,L2,L3 wires top	1503208	ZMS932-PI	2CCF182551R0001	1	2.5	0.058
Adapter MS116 and MS132 without wires, Spare parts						
Adapter for MS without wires	1414559	ZMS934	2CCA182512R0001	1	2.5	0.034
Intermediate piece 9mm	1414412	ZMS935	2CCA182616R0001	1	2.5	0.007
Adapter for AF contactor no wires	1414542	ZMS938	2CCA182510R0001		2.5	0.0034
Connection pin to mount 2 combi modules together	1414801	E210-SPV	2CCC703715R0001	Set of 30 pces		0.01

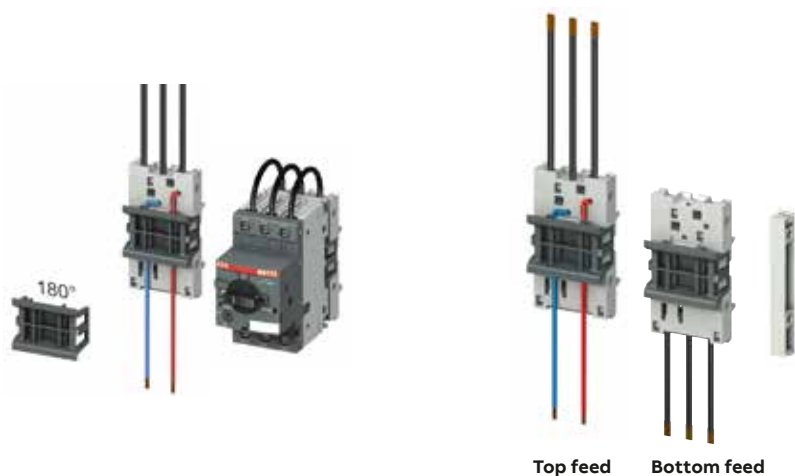

SMISLINE TP plug-in system

Locking device



SA

Locking device for S400, F402, F404, FS401, FS403

Designation	Bbn	Order details		Price	Weight	Pack
	401223			1 piece	1 piece	unit
	EAN	Type code	Order code		kg	pc.
Padlock adapter 3 mm – Bag containing 10 items	3587605	SA 1	GJF1101903R0001		0.023	1
Padlock set. Locking devices with 2 keys	3587704	SA 2	GJF1101903R0002		0.020	1

SMISLINE TP plug-in system

DIN-rail adapters 32A and 63A

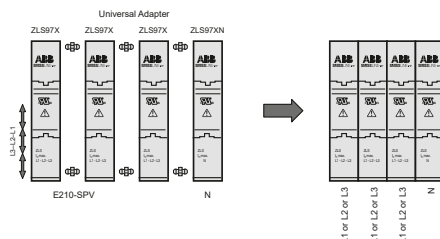

Multipole universal adapter can be plugged together with single adapters and the connection piece E210SPV.

Adapters can be used on the 125A or on the 250A busbar system.

32A and 63A DIN-rail adapters

Adapter 32A



DIN adapter 32A

Designation	Module	Bbn 761227	Order details		Price 1 piece	Weight 1 piece kg	Pack unit pc.
			EAN	Type code			
L1/L2/L3 wire top	1	144 4563	ZLS970	2CCA180551R0001		0.020	1
L1/L2/L3 wire bottom	1	144 4570	ZLS971	2CCA180552R0001		0.020	1
N wire top	1	144 4587	ZLS970N	2CCA180553R0001		0.020	1
N wire bottom	1	144 4570	ZLS971N	2CCA180554R0001		0.020	1

Adapter 63A



DIN adapter 63A

L1/L2/L3 wire top	1	144 4709	ZLS972	2CCA180555R0001		0.024	1
L1/L2/L3 wire bottom	1	144 4716	ZLS973	2CCA180556R0001		0.024	1
N wire top	1	144 4808	ZLS972N	2CCA180557R0001		0.024	1
N wire bottom	1	144 4730	ZLS973N	2CCA180558R0001		0.024	1

Adapter 32A with 300mm wire

L1/L2/L3 wire top	1	144 4747	ZLS970300	2CCA180559R0001		0.026	1
L1/L2/L3 wire bottom	1	144 4754	ZLS971300	2CCA180560R0001		0.026	1
N wire top	1	144 4761	ZLS970N300	2CCA180561R0001		0.026	1
N wire bottom	1	144 4778	ZLS971N300	2CCA180562R0001		0.026	1

Adapter 63A with 300mm wire

L1/L2/L3	1	144 4785	ZLS972300	2CCA180563R0001		0.037	1
L1/L2/L3	1	144 4792	ZLS973300	2CCA180564R0001		0.037	1
N wire top	1	144 4808	ZLS972N300	2CCA180565R0001		0.037	1
N wire bottom	1	144 4815	ZLS973N300	2CCA180566R0001		0.037	1



Example DIN adapter

Adapter 25A UL489, adapter can be only used together with ABB Pro M MCB S200 UL489

L1/L2/L3 wire top	1	144 4822	ZLS970UL	2CCA337020R0001		0.021	1
L1/L2/L3 wire bottom	1	144 4839	ZLS971UL	2CCA337021R0001		0.021	1

Adapter 45A UL489, adapter can be only used together with ABB Pro M MCB S200 UL489

L1/L2/L3 wire top	1	144 4860	ZLS972UL	2CCA337024R0001		0.025	1
L1/L2/L3 wire bottom	1	144 4877	ZLS973UL	2CCA337025R0001		0.025	1



UL489 adapter

Dummy housing

	1	144 4556	ZLS964	2CCA180550R0001		0.011	1
--	---	----------	--------	-----------------	--	-------	---

Connector for multi- pole adapter

Bag with 30 pcs. 10 2 connectors are needed to connect 2 adapters		1414801	E210-SPV	2CCC703715R0001		0.050	Set of 30 pcs.
---	--	---------	----------	-----------------	--	-------	-------------------------



SMISLINE TP plug-in system

DIN-rail adapters - 27mm wide Solution for S800

Simple mounting S800 MCB on SMISLINE TP system with 27mm width DIN-rail adapter. Assembly to plug-in socket system with DIN-rail adapter and S800. Maximum rated current of outgoing circuits (Inc) max. 50A for S800 with ZLS972X, ZLS973X.

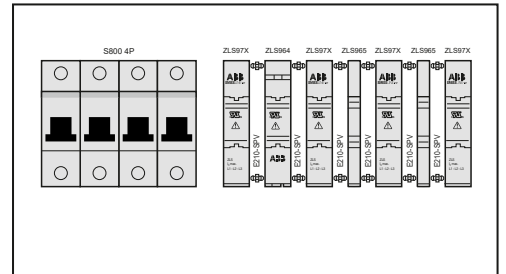
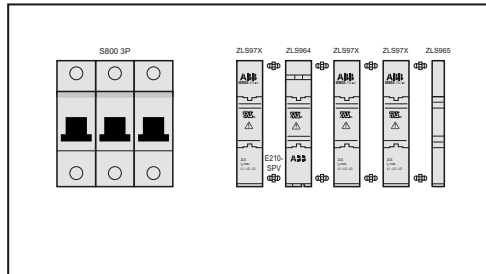
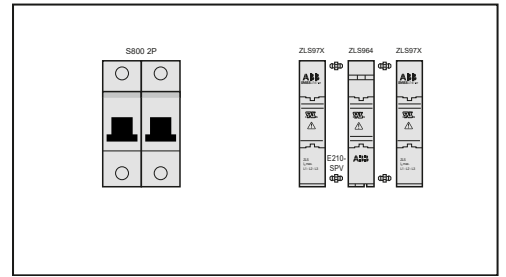
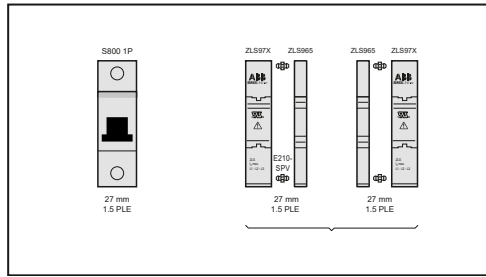

9mm dummy housing



Description	Bbn		Order details		Module	Weight 1 piece	Pack unit
	761227	EAN	Type code	Order code			
9mm width	1501440	ZLS965	2CCA180545R1001	0.5	0.005	Set of 5	

SMISLINE TP plug-in system

Busbars 40A and 125A

40A and 125A busbars / selection table for sockets

Bbn 761227	Order details		Price 1	ZL S908	ZL S906	Mod.	Length incl. end piece	Busbar length	Bbn 761227	Order details		Price 1
EAN	busbar 125A Type code	Order code	piece				mm	mm	EAN	busbar 40A Type code	Order code	piece
0016778	ZLS201E6	2CCF800158R0001	-	1	6	148	103	007966	ZLS203E6	2CCF800218R0001		
0016983	ZLS201E8	2CCF800159R0001	1	-	8	186	139	008178	ZLS203E8	2CCF800219R0001		
0016211	ZLS201E12	2CCF800160R0001	-	2	12	256	211	007409	ZLS203E12	2CCF800220R0001		
0016310	ZLS201E14	2CCF800161R0001	1	1	14	292	247	007508	ZLS203E14	2CCF800221R0001		
0016334	ZLS201E16	2CCF800162R0001	2	-	16	328	283	007522	ZLS203E16	2CCF800222R0001		
0016358	ZLS201E18	2CCF800163R0001	-	3	18	364	319	007546	ZLS203E18	2CCF800223R0001		
0016372	ZLS201E20	2CCF800164R0001	1	2	20	401	355	007560	ZLS203E20	2CCF800224R0001		
0016396	ZLS201E22	2CCF800165R0001	2	1	22	437	391	007584	ZLS203E22	2CCF800225R0001		
0016419	ZLS201E24	2CCF800666R0001	3	-	24	473	427	007607	ZLS203E24	2CCF800226R0001		
0016433	ZLS201E26	2CCF800167R0001	1	3	26	509	463	007621	ZLS203E26	2CCF800227R0001		
0016457	ZLS201E28	2CCF800168R0001	2	2	28	545	499	007645	ZLS203E28	2CCF800228R0001		
0016471	ZLS201E30	2CCF800169R0001	3	1	30	581	535	007669	ZLS203E30	2CCF800229R0001		
0016495	ZLS201E32	2CCF800170R0001	4	-	32	617	571	007683	ZLS203E32	2CCF800230R0001		
0016518	ZLS201E34	2CCF800171R0001	2	3	34	653	607	007706	ZLS203E34	2CCF800231R0001		
0016532	ZLS201E36	2CCF800172R0001	3	2	36	689	643	007720	ZLS203E36	2CCF800232R0001		
0016556	ZLS201E38	2CCF800173R0001	4	1	38	725	679	007744	ZLS203E38	2CCF800233R0001		
0016570	ZLS201E40	2CCF800174R0001	5	-	40	761	715	007768	ZLS203E40	2CCF800234R0001		
0016594	ZLS201E42	2CCF800175R0001	3	3	42	797	751	007782	ZLS203E42	2CCF800235R0001		
0016617	ZLS201E44	2CCF800176R0001	4	2	44	833	787	007805	ZLS203E44	2CCF800236R0001		
0016631	ZLS201E46	2CCF800177R0001	5	1	46	869	823	007829	ZLS203E46	2CCF800237R0001		
0016655	ZLS201E48	2CCF800178R0001	6	-	48	905	859	007843	ZLS203E48	2CCF800238R0001		
0016679	ZLS201E50	2CCF800179R0001	4	3	50	941	895	007867	ZLS203E50	2CCF800239R0001		
0016693	ZLS201E52	2CCF800180R0001	5	2	52	977	932	007881	ZLS203E52	2CCF800240R0001		
0016716	ZLS201E54	2CCF800181R0001	6	1	54	1013	968	007904	ZLS203E54	2CCF800241R0001		
0016730	ZLS201E56	2CCF800182R0001	7	-	56	1049	1004	007928	ZLS203E56	2CCF800242R0001		
0016754	ZLS201E58	2CCF800183R0001	5	3	58	1085	1040	007942	ZLS203E58	2CCF800243R0001		
0016785	ZLS201E60	2CCF800184R0001	6	2	60	1122	1076	007973	ZLS203E60	2CCF800244R0001		
0016808	ZLS201E62	2CCF800185R0001	7	1	62	1158	1112	007997	ZLS203E62	2CCF800245R0001		
0016822	ZLS201E64	2CCF800186R0001	8	-	64	1194	1148	008017	ZLS203E64	2CCF800246R0001		
0016846	ZLS201E66	2CCF800187R0001	6	3	66	1230	1184	008031	ZLS203E66	2CCF800247R0001		
0016860	ZLS201E68	2CCF800188R0001	7	2	68	1266	1220	008055	ZLS203E68	2CCF800248R0001		
0016884	ZLS201E70	2CCF800189R0001	8	1	70	1302	1256	008079	ZLS203E70	2CCF800249R0001		
0016907	ZLS201E72	2CCF800190R0001	9	-	72	1338	1292	008093	ZLS203E72	2CCF800250R0001		
0016921	ZLS201E74	2CCF800191R0001	7	3	74	1374	1328	008116	ZLS203E74	2CCF800251R0001		
0016945	ZLS201E76	2CCF800192R0001	8	2	76	1410	1364	008130	ZLS203E76	2CCF800252R0001		
0016969	ZLS201E78	2CCF800193R0001	9	1	78	1446	1400	008154	ZLS203E78	2CCF800253R0001		
0016990	ZLS201E80	2CCF800194R0001	10	-	80	1482	1436	008185	ZLS203E80	2CCF800254R0001		
0017010	ZLS201E82	2CCF800195R0001	8	3	82	1518	1472	008208	ZLS203E82	2CCF800255R0001		
0017034	ZLS201E84	2CCF800196R0001	9	2	84	1554	1508	008222	ZLS203E84	2CCF800256R0001		
0017058	ZLS201E86	2CCF800197R0001	10	1	86	1590	1544	008246	ZLS203E86	2CCF800257R0001		
0017072	ZLS201E88	2CCF800198R0001	11	-	88	1626	1580	008260	ZLS203E88	2CCF800258R0001		
0017096	ZLS201E90	2CCF800199R0001	9	3	90	1662	1616	008284	ZLS203E90	2CCF800259R0001		
0017119	ZLS201E92	2CCF800200R0001	10	2	92	1698	1652	008307	ZLS203E92	2CCF800260R0001		
0017133	ZLS201E94	2CCF800201R0001	11	1	94	1734	1688	008321	ZLS203E94	2CCF800261R0001		
0017157	ZLS201E96	2CCF800202R0001	12	-	96	1770	1724	008345	ZLS203E96	2CCF800262R0001		
0017171	ZLS201E98	2CCF800203R0001	10	3	98	1806	1760	008369	ZLS203E98	2CCF800263R0001		
0016006	ZLS201E100	2CCF800204R0001	11	2	100	1843	1796	007195	ZLS203E100	2CCF800264R0001		
0016020	ZLS201E102	2CCF800205R0001	12	1	102	1879	1832	007218	ZLS203E102	2CCF800265R0001		
0016044	ZLS201E104	2CCF800206R0001	13	-	104	1915	1868	007232	ZLS203E104	2CCF800266R0001		
0016068	ZLS201E106	2CCF800207R0001	11	3	106	1951	1904	007256	ZLS203E106	2CCF800267R0001		
0016082	ZLS201E108	2CCF800208R0001	12	2	108	1987	1940	007270	ZLS203E108	2CCF800268R0001		

Planning for the incorporation of feeder block and spare places should be taken into account.
The total lengths given above were calculated taking socket spacings and tolerances into account.
For this reason, the indicated busbar length is not necessarily a multiple of 18mm (1 Module).

SMISLINE TP plug-in system

Technical data according to IEC/EN 61439-6

Power Bar System 250 A

Busbar system touch proof:

Use only for wall mounted application (horizontal or vertical). When installed correctly the requirements of EN/IEC 61439-2 are met.

Number of poles	30 to 110 3p+N / 2 additional bars PE+N
Rated operational voltage (U_e)	690 VAC, 440 VDC (400 V for LA, LB busbars)
Rated insulation voltage (U_i) Main circuit	690 VAC, 440 VDC
Rated insulation voltage (U_i) Auxiliary circuit	415 VAC
IP Code	IP20B
Mounting position	horizontal or vertical
Overvoltage category	IV
Pollution degree	3 (690 V a.c.) 2 (1000 V d.c.)
Rated impulse voltage (U_{imp})	8 kV mainbusbars; 6 kV auxiliary busbars
Rated current of the assembly (I_n)	Side feed: 250 A, Middle feed 400 A, Auxiliary busbars: 40 A
Rated current of a circuit (I_{nc})	Main circuit: Max. 100 A
Rated current of Auxiliary circuit	40 A
Rated short-time withstand current (I_{cw})	15 kA/100 ms Main circuit, 4 kA/50 ms Auxiliary circuit
Rated peak withstand current Main circuit (I_{pk})	30 kA
Rated peak withstand current Auxiliary circuit (I_{pk})	6 kA
Rated frequency (f)	50/60 Hz
Rated conditional short-circuit current (I_{cc})	see table below
Ambient air temperature	max. 60°C
Environmental conditions (damp heat) acc. to IEC/EN 60068-2-30	1 cycle with 55°C/90...96% and 25°C/95...100%
Size of CU bars 3P+N+PE	3×25 mm (75 mm ²)
Size of CU auxiliary bars La Lb	2×5 mm (10 mm ²)
Resistance and reactance values Busbar ZLSP1250	R 0.325 mΩ/m X 0.295 mΩ/m

Rated Voltage (U_e)	Rated conditional short-circuit current (I_{cc})	Incoming current of main busbars (L1, L2, L3, N)	Short circuit protection device (SCPD)		
			Fuse	MCCB	
415 V	100 kA	250 A	NH2 gG 690V/250A*	ABB T _{max} XT Serie up to 250A*	
690 V	25 kA	250 A	NH2 gG 690V/250A	ABB T _{max} XT Serie up to 250A*	
		Inocming current of auxiliary busbars (La, Lb)			
		25 kA	40 A	NH00 gG 415 V/40 A	ABB Type S800 (240/415 VAC)

* For 400 A Incoming for upstream protection are two fuses or XT breaker necessary or two XT circuit breaker

SMISLINE TP plug-in system

Technical data data UL508; Approvals for US and CA: cULus

Busbar system 250 A

SMISLINE TP system for UL 508 – Industrial Control Equipment, CSA C22.2 No. 14 – Industrial Control Equipment UL File E222110

Rated Voltage	600 VAC
Rated Current	250A left or right
Short Circuit Ratings ABB T _{max} XT2, XT4	50 kA, max. 480 VAC, 480Y/277 V and 240 VAC or 35 kA, max. 600 VAC and 600Y/347 V

Technical data UL508 Industrial Control Equipment (ZLSP906, ZLSP908, ZLSP920)

	Busbar ZLSP200	Feeder ZLSP934	Feeder block ZLS95X	Combimodule ZLS840X, 842X	DIN Rail adapter ZLS97X	Terminals ZLS95XUL, 91XUL	Combi modul ZMS132X	Adapter moter strater ZMS93X
Maximum rated voltage	600 VAC	600 VAC	600 VAC	600 VAC	600 VAC	600 VAC	600 VAC	600 VAC
Maximum rated current	250 A	250 A	150 A	30 A	32 A, 63 A	32 A, 100 A, 150 A	32 A	32 A

DIN rail adapters for MCB SU200 and SUP200

	ZLS970UL, ZLS971UL, ZLS972UL or ZLS973UL
Maximum nominal current	25 A, 45 A

SMISLINE TP plug-in system

Starter pack Touch proof 3L

Power Bar System 250 A

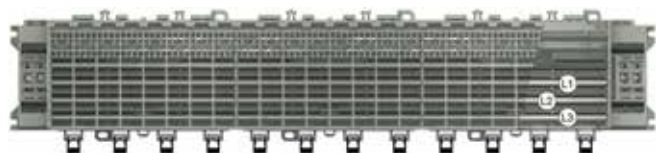

Starter pack Touch proof 3L Busbar system 250 A

Solutions available	Busbars length incl. Socket end piece mm	Type name	ABB IT number	EAN number 761227	Pack unit	Weight 1 piece kg
30 modules 3L	607	ZLSP950E30-3L	2CCF212200A0001	1488246	1	1,755
32 modules 3L	643	ZLSP950E32-3L	2CCF212201A0001	1488260	1	1,863
34 modules 3L	679	ZLSP950E34-3L	2CCF212202A0001	1488284	1	1,981
36 modules 3L	715	ZLSP950E36-3L	2CCF212203A0001	1488307	1	2,088
38 modules 3L	751	ZLSP950E38-3L	2CCF212204A0001	1488321	1	2,195
40 modules 3L	787	ZLSP950E40-3L	2CCF212205A0001	1488345	1	2,303
42 modules 3L	823	ZLSP950E42-3L	2CCF212206A0001	1488369	1	2,421
44 modules 3L	859	ZLSP950E44-3L	2CCF212207A0001	1488383	1	2,528
46 modules 3L	895	ZLSP950E46-3L	2CCF212208A0001	1488406	1	2,635
48 modules 3L	931	ZLSP950E48-3L	2CCF212209A0001	1488420	1	2,742
50 modules 3L	967	ZLSP950E50-3L	2CCF212210A0001	1488444	1	2,861
52 modules 3L	1003	ZLSP950E52-3L	2CCF212211A0001	1488468	1	2,968
54 modules 3L	1039	ZLSP950E54-3L	2CCF212212A0001	1488482	1	3,075
56 modules 3L	1075	ZLSP950E56-3L	2CCF212213A0001	1488505	1	3,182
58 modules 3L	1111	ZLSP950E58-3L	2CCF212214A0001	1488529	1	3,301
60 modules 3L	1147	ZLSP950E60-3L	2CCF212215A0001	1488543	1	3,408
62 modules 3L	1183	ZLSP950E62-3L	2CCF212216A0001	1488567	1	3,515
64 modules 3L	1219	ZLSP950E64-3L	2CCF212217A0001	1488581	1	3,622
66 modules 3L	1255	ZLSP950E66-3L	2CCF212218A0001	1488604	1	3,741
68 modules 3L	1291	ZLSP950E68-3L	2CCF212219A0001	1488628	1	3,848
70 modules 3L	1327	ZLSP950E70-3L	2CCF212220A0001	1488642	1	3,955
72 modules 3L	1363	ZLSP950E72-3L	2CCF212221A0001	1488666	1	4,062
74 modules 3L	1399	ZLSP950E74-3L	2CCF212222A0001	1488680	1	4,18
76 modules 3L	1435	ZLSP950E76-3L	2CCF212223A0001	1488703	1	4,288
78 modules 3L	1471	ZLSP950E78-3L	2CCF212224A0001	1488727	1	4,395
80 modules 3L	1507	ZLSP950E80-3L	2CCF212225A0001	1488741	1	4,502
82 modules 3L	1543	ZLSP950E82-3L	2CCF212226A0001	1488765	1	4,62
84 modules 3L	1579	ZLSP950E84-3L	2CCF212227A0001	1488789	1	4,728
86 modules 3L	1615	ZLSP950E86-3L	2CCF212228A0001	1488802	1	4,835
88 modules 3L	1651	ZLSP950E88-3L	2CCF212229A0001	1488826	1	4,942
90 modules 3L	1687	ZLSP950E90-3L	2CCF212230A0001	1488840	1	5,06
92 modules 3L	1723	ZLSP950E92-3L	2CCF212231A0001	1488864	1	5,167
94 modules 3L	1759	ZLSP950E94-3L	2CCF212232A0001	1488888	1	5,275
96 modules 3L	1795	ZLSP950E96-3L	2CCF212233A0001	1488901	1	5,382
98 modules 3L	1831	ZLSP950E98-3L	2CCF212234A0001	1488925	1	5,5
100 modules 3L	1867	ZLSP950E100-3L	2CCF212235A0001	1488949	1	5,607
102 modules 3L	1903	ZLSP950E102-3L	2CCF212236A0001	1488963	1	5,715
104 modules 3L	1939	ZLSP950E104-3L	2CCF212237A0001	1488987	1	5,822
106 modules 3L	1975	ZLSP950E106-3L	2CCF212238A0001	1489007	1	5,94
108 modules 3L	2011	ZLSP950E108-3L	2CCF212239A0001	1489021	1	6,047
110 modules 3L	2047	ZLSP950E110-3L	2CCF212240A0001	1489045	1	6,121

SMISLINE TP plug-in system

Starter pack Touch proof 3LN

Power Bar System 250 A

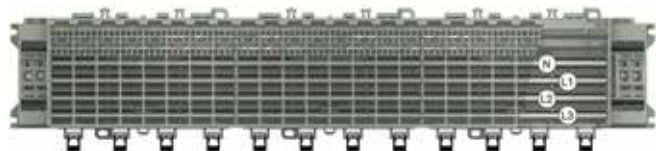

Starter pack Touch proof 3LN Busbar system 250 A

Solutions available	Busbars length incl. Socket end piece mm	Type name	ABB IT number	EAN number 761 227	Pack unit	Weight 1 piece kg
30 modules 3LN	607	ZLSP950E30-3LN	2CCF212300A0001	1489069	1	2,122
32 modules 3LN	643	ZLSP950E32-3LN	2CCF212301A0001	1489083	1	2,253
34 modules 3LN	679	ZLSP950E34-3LN	2CCF212302A0001	1489106	1	2,396
36 modules 3LN	715	ZLSP950E36-3LN	2CCF212303A0001	1489120	1	2,527
38 modules 3LN	751	ZLSP950E38-3LN	2CCF212304A0001	1489144	1	2,659
40 modules 3LN	787	ZLSP950E40-3LN	2CCF212305A0001	1489168	1	2,791
42 modules 3LN	823	ZLSP950E42-3LN	2CCF212306A0001	1489182	1	2,933
44 modules 3LN	859	ZLSP950E44-3LN	2CCF212307A0001	1489205	1	3,065
46 modules 3LN	895	ZLSP950E46-3LN	2CCF212308A0001	1489229	1	3,197
48 modules 3LN	931	ZLSP950E48-3LN	2CCF212309A0001	1489243	1	3,328
50 modules 3LN	967	ZLSP950E50-3LN	2CCF212310A0001	1489267	1	3,471
52 modules 3LN	1003	ZLSP950E52-3LN	2CCF212311A0001	1489281	1	3,603
54 modules 3LN	1039	ZLSP950E54-3LN	2CCF212312A0001	1489304	1	3,734
56 modules 3LN	1075	ZLSP950E56-3LN	2CCF212313A0001	1489328	1	3,866
58 modules 3LN	1111	ZLSP950E58-3LN	2CCF212314A0001	1489342	1	4,008
60 modules 3LN	1147	ZLSP950E60-3LN	2CCF212315A0001	1489366	1	4,14
62 modules 3LN	1183	ZLSP950E62-3LN	2CCF212316A0001	1489380	1	4,272
64 modules 3LN	1219	ZLSP950E64-3LN	2CCF212317A0001	1489403	1	4,403
66 modules 3LN	1255	ZLSP950E66-3LN	2CCF212318A0001	1489427	1	4,546
68 modules 3LN	1291	ZLSP950E68-3LN	2CCF212319A0001	1489441	1	4,678
70 modules 3LN	1327	ZLSP950E70-3LN	2CCF212320A0001	1489465	1	4,809
72 modules 3LN	1363	ZLSP950E72-3LN	2CCF212321A0001	1489489	1	4,941
74 modules 3LN	1399	ZLSP950E74-3LN	2CCF212322A0001	1489502	1	5,084
76 modules 3LN	1435	ZLSP950E76-3LN	2CCF212323A0001	1489526	1	5,215
78 modules 3LN	1471	ZLSP950E78-3LN	2CCF212324A0001	1489540	1	5,347
80 modules 3LN	1507	ZLSP950E80-3LN	2CCF212325A0001	1489564	1	5,478
82 modules 3LN	1543	ZLSP950E82-3LN	2CCF212326A0001	1489588	1	5,621
84 modules 3LN	1579	ZLSP950E84-3LN	2CCF212327A0001	1489601	1	5,753
86 modules 3LN	1615	ZLSP950E86-3LN	2CCF212328A0001	1489625	1	5,884
88 modules 3LN	1651	ZLSP950E88-3LN	2CCF212329A0001	1489649	1	6,016
90 modules 3LN	1687	ZLSP950E90-3LN	2CCF212330A0001	1489663	1	6,159
92 modules 3LN	1723	ZLSP950E92-3LN	2CCF212331A0001	1489687	1	6,29
94 modules 3LN	1759	ZLSP950E94-3LN	2CCF212332A0001	1489700	1	6,422
96 modules 3LN	1795	ZLSP950E96-3LN	2CCF212333A0001	1489724	1	6,554
98 modules 3LN	1831	ZLSP950E98-3LN	2CCF212334A0001	1489748	1	6,696
100 modules 3LN	1867	ZLSP950E100-3LN	2CCF212335A0001	1489762	1	6,828
102 modules 3LN	1903	ZLSP950E102-3LN	2CCF212336A0001	1489786	1	6,959
104 modules 3LN	1939	ZLSP950E104-3LN	2CCF212337A0001	1489809	1	7,091
106 modules 3LN	1975	ZLSP950E106-3LN	2CCF212338A0001	1489823	1	7,234
108 modules 3LN	2011	ZLSP950E108-3LN	2CCF212339A0001	1489847	1	7,365
110 modules 3LN	2047	ZLSP950E110-3LN	2CCF212340A0001	1489861	1	7,463

SMISLINE TP plug-in system

Starter pack Touch proof 3LN LA LB

Power Bar System 250 A

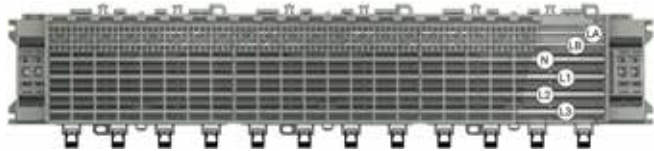

Starter pack Touch proof 3LNLALB Busbar system 250 A

Solutions available	Busbars length incl. Socket end piece mm	Type name	ABB IT number	EAN number 761 227	Pack unit	Weight 1 piece kg
30 modules 3LN LA LB	607	ZLSP950E30-3LNLALB	2CCF212400A0001	1489885	1	2,48
32 modules 3LN LA LB	643	ZLSP950E32-3LNLALB	2CCF212401A0001	1489908	1	2,611
34 modules 3LN LA LB	679	ZLSP950E34-3LNLALB	2CCF212402A0001	1489922	1	2,754
36 modules 3LN LA LB	715	ZLSP950E36-3LNLALB	2CCF212403A0001	1489946	1	2,885
38 modules 3LN LA LB	751	ZLSP950E38-3LNLALB	2CCF212404A0001	1489960	1	3,017
40 modules 3LN LA LB	787	ZLSP950E40-3LNLALB	2CCF212405A0001	1489984	1	3,149
42 modules 3LN LA LB	823	ZLSP950E42-3LNLALB	2CCF212406A0001	1490003	1	3,291
44 modules 3LN LA LB	859	ZLSP950E44-3LNLALB	2CCF212407A0001	1490027	1	3,423
46 modules 3LN LA LB	895	ZLSP950E46-3LNLALB	2CCF212408A0001	1490041	1	3,555
48 modules 3LN LA LB	931	ZLSP950E48-3LNLALB	2CCF212409A0001	1490065	1	3,686
50 modules 3LN LA LB	967	ZLSP950E50-3LNLALB	2CCF212410A0001	1490089	1	3,829
52 modules 3LN LA LB	1003	ZLSP950E52-3LNLALB	2CCF212411A0001	1490102	1	3,961
54 modules 3LN LA LB	1039	ZLSP950E54-3LNLALB	2CCF212412A0001	1490126	1	4,092
56 modules 3LN LA LB	1075	ZLSP950E56-3LNLALB	2CCF212413A0001	1490140	1	4,224
58 modules 3LN LA LB	1111	ZLSP950E58-3LNLALB	2CCF212414A0001	1490164	1	4,366
60 modules 3LN LA LB	1147	ZLSP950E60-3LNLALB	2CCF212415A0001	1490188	1	4,498
62 modules 3LN LA LB	1183	ZLSP950E62-3LNLALB	2CCF212416A0001	1490201	1	4,63
64 modules 3LN LA LB	1219	ZLSP950E64-3LNLALB	2CCF212417A0001	1490225	1	4,761
66 modules 3LN LA LB	1255	ZLSP950E66-3LNLALB	2CCF212418A0001	1490249	1	4,904
68 modules 3LN LA LB	1291	ZLSP950E68-3LNLALB	2CCF212419A0001	1490263	1	5,036
70 modules 3LN LA LB	1327	ZLSP950E70-3LNLALB	2CCF212420A0001	1490287	1	5,167
72 modules 3LN LA LB	1363	ZLSP950E72-3LNLALB	2CCF212421A0001	1490300	1	5,299
74 modules 3LN LA LB	1399	ZLSP950E74-3LNLALB	2CCF212422A0001	1490324	1	5,442
76 modules 3LN LA LB	1435	ZLSP950E76-3LNLALB	2CCF212423A0001	1490348	1	5,573
78 modules 3LN LA LB	1471	ZLSP950E78-3LNLALB	2CCF212424A0001	1490362	1	5,705
80 modules 3LN LA LB	1507	ZLSP950E80-3LNLALB	2CCF212425A0001	1490386	1	5,836
82 modules 3LN LA LB	1543	ZLSP950E82-3LNLALB	2CCF212426A0001	1490409	1	5,979
84 modules 3LN LA LB	1579	ZLSP950E84-3LNLALB	2CCF212427A0001	1490423	1	6,111
86 modules 3LN LA LB	1615	ZLSP950E86-3LNLALB	2CCF212428A0001	1490447	1	6,242
88 modules 3LN LA LB	1651	ZLSP950E88-3LNLALB	2CCF212429A0001	1490461	1	6,374
90 modules 3LN LA LB	1687	ZLSP950E90-3LNLALB	2CCF212430A0001	1490485	1	6,517
92 modules 3LN LA LB	1723	ZLSP950E92-3LNLALB	2CCF212431A0001	1490508	1	6,648
94 modules 3LN LA LB	1759	ZLSP950E94-3LNLALB	2CCF212432A0001	1490522	1	6,78
96 modules 3LN LA LB	1795	ZLSP950E96-3LNLALB	2CCF212433A0001	1490546	1	6,912
98 modules 3LN LA LB	1831	ZLSP950E98-3LNLALB	2CCF212434A0001	1490560	1	7,054
100 modules 3LN LA LB	1867	ZLSP950E100-3LNLALB	2CCF212435A0001	1490584	1	7,186
102 modules 3LN LA LB	1903	ZLSP950E102-3LNLALB	2CCF212436A0001	1490607	1	7,317
104 modules 3LN LA LB	1939	ZLSP950E104-3LNLALB	2CCF212437A0001	1490621	1	7,449
106 modules 3LN LA LB	1975	ZLSP950E106-3LNLALB	2CCF212438A0001	1490645	1	7,592
108 modules 3LN LA LB	2011	ZLSP950E108-3LNLALB	2CCF212439A0001	1490669	1	7,723
110 modules 3LN LA LB	2047	ZLSP950E110-3LNLALB	2CCF212440A0001	1490683	1	7,821

SMISLINE TP plug-in system

Sockets and Incoming components

Power Bar System 250 A



ZLSP906



ZLSP908



ZLSP1250



ZLSP920



ZLSP921



ZLSP25x



ZLSP95x

Socket base

Description	Type name	ABB IT number	EAN number 761227	Pack unit	Moduls (1 PLE 18mm)	Weight in grams
6-module socket Length 108 mm (includes base and cover)	ZLSP906	2CCF212053A0001	1487324	10	6	113
8-module socket Length 144 mm (includes base and cover)	ZLSP908	2CCF212052A0001	1487300	10	8	147

Busbars for the sockets

Description	Type name	ABB IT number	EAN number 761 227	Pack-aging unit	Module	Weight in grams
250A busbar plated, 25x3 mm, for L1, L2, L3, N and PE – Delivery length 1979 mm	ZLSP1250	2CCF212100M0110	1488222	1	110	1343
40A auxiliary busbar plated, 5x2 mm, for LA und LB – Delivery length 1979 mm	ZLS202	2CCF002773R0001	0015719	10	110	240

Socket end piece

Description	Type name	ABB IT number	EAN number 761 227	Pack-aging unit	Module	Weight in grams
End piece main socket ZLSP906 or ZLSP908	ZLSP920	2CCF212082A0001	1487386	1	2	103
End piece additional socket ZLSP926 or ZLSP928	ZLSP921	2CCF212085A0001	1487409	1	2	54

Incoming terminal component

50 mm² up to 120 mm² flex wire with ferrule, max. 1 wire

10 mm²–25 mm² 2 wires with ferrule

Version	Type name	ABB IT number	EAN number 761 227	Pack-aging unit	Module	Weight in grams
Feeder component N	ZLSP250	2CCV672600R0001	1490782	1	2	112
Feeder component L1	ZLSP251	2CCV672601R0001	1490805	1	2	112
Feeder component L2	ZLSP252	2CCV672602R0001	1490829	1	2	112
Feeder component L3	ZLSP253	2CCV672603R0001	1490843	1	2	112
Feeder component N additional socket	ZLSP954	2CCV672608R0001	1490867	1	2	100
Feeder component N additional socket (2 holes)	ZLSP954-1	2CCR183393A7001	1452797	1	2	100
Feeder component PE additional socket	ZLSP959	2CCV672609R0001	1490881	1	2	100

SMISLINE TP plug-in system

Incoming bolt on 250A

Technical data IEC/EN 61439-6 and UL508



ZLSP934-3LN



ZLSP934-3L-1



ZLSP934-3LN-R



ZLSP934-3L-R



ZLSP935-8NPE



ZLSP935-8PE_L_PE



ZLSP935-8NPE-R



ZLSP935-8PE-R_PE

	ZLSP934 and 935	ZLSP25X,ZLSP95X
Standards	IEC/EN 61439-6	IEC/EN 61439-7, UL508
Rated voltage Ue acc. IEC acc. IEC	690 VAC	690 VAC
Rated Voltage acc. UL	600 V AC	-
Rated current In acc.. IEC	250A (center feed or side feed): 400 A max. when used with two feeder blocks	250A
Rated current In acc. UL	250A (short circuit protection 250 A Circuit-Breaker (DIVQ/7) 50 kA (480 V); 35 kA (600 V))	-
Wire size IEC connections	Cable: 50 mm ² up to 150 mm ² ; no flat cable Ring lug M8 (for example Klauke 9SG8 for 120mm ² or 10SG8 for 150mm ²)	35–120 mm ² one flexible wire with ferrule 10–25 mm ² one or two flexible wire with ferrule
Wire size UL connections	4/0AWG – 250 kcmil	-
Torque	8NmCover 1,2 Nm	ZLSP250–253 2,5 NmZLSP954, 959 2,0 NmCover 1,2 Nm
Stripping length	Ring lug M8; Width: max 22 mm	21mm

SMISLINE TP plug-in system

Incoming bolt-on solution

Power Bar System 250 A



ZLSP934 x



ZLSP935 x



ZLSP934 x and ZLSP935 x



ZLSP963



ZLSP963N-N



ZLSP964

Connection can be done with ring lug like Klauke 9SG8 for 120mm² or 10SG8 for 150mm².

Connection of two socket rows is possible.

Main socket

Description	Bbn 761227	Order details		Price 1 piece	Weight 1 piece	Pack unit
		EAN	Type code			
Incoming terminal block 3L 8PLE left 250A	1506124	ZLSP934-3L-1	2CCG000036R0001		0.438	1
Incoming terminal block 3L+N 8PLE left 250A	1506148	ZLSP934-3LN	2CCG000038R0001		0.528	1
Incoming terminal block 3L 8PLE right 250A	1506155	ZLSP934-3L-R-1	2CCG000039R0001		0.438	1
Incoming terminal block 3L+N 8PLE right 250A	1506179	ZLSP934-3LN-R	2CCG000041R0001		0.528	1
Additional socket - This solution is only possible to mount on a ZLSP928 (not on ZLSP926, ZLS926, ZLS928).						
Incoming terminal block additional socket N PE left 250A 8PLE	1506186	ZLSP935-8NPE	2CCG000042R0001		0.268	1
Incoming terminal block additional socket PE left 250A 8PLE	1506193	ZLSP935-8PE	2CCG000043R0001		0.178	1
Incoming terminal block additional socket N PE right 250A 8PLE	1506223	ZLSP935-8NPE-R	2CCG000046R0001		0.268	1
Incoming terminal block additional socket PE right 250A 8PLE	1506230	ZLSP935-8PE-R	2CCG000047R0001		0.178	1
Covers for ZLSP934						
Cover for Incoming terminal block 250A (only for replacement)	1506278	ZLSP963	2CCG000051R0001		0.018	1
Cover an connection N-N 250A Connection to wire N from main socket to additional socket. Can only use for M8 120 mm ² . Feeding is only possible form the main socket side.	1506261	ZLSP963N-N	2CCG000050R0001		0.074	1
Cover for connection with the cables on one terminal	1507541	ZLSP964	2CCG000207R0001		0.034	4

SMISLINE TP plug-in system

Additional socket

Power Bar System 250 A

Additional socket

The additional socket can easily be fitted onto the socket base to accommodate the external N and/or PE busbars. This enables neutral connections to be made where single-pole miniature circuit breakers are used with unswitched neutral. Neutral terminals are clipped onto the additional socket and can be used as detachable neutral connections. One N busbar and/or one PE busbar can be fitted. Each socket base can be equipped with an additional socket.

Additional socket for external N and PE busbars

	Type name	ABB IT number	EAN number 761227	Packaging unit	Module	Weight in grams
– 8-module socket (suitable for 8-module socket)	ZLSP928	2CCF212060A0001	1487348	10	8	67
– 6-module socket (suitable for 6-module socket)	ZLSP926	2CCF212061A0001	1487362	10	6	53



ZLSP928



ZLSP926

Busbar insulator

	Type name	ABB IT number	EAN number 761227	Packaging unit	Module	Weight in grams
dark grey, 20 for isolation and spacing of separate busbar sections, 18 mm	ZLS938	2CCA205611R0001	148205	1	1	1



ZLS938

Busbar cover

	Type name	ABB IT number	EAN number 761227	Packaging unit	Module	Weight in grams
electrically protected covering of main and auxiliary busbars. The 4 modules cover can be divided. Suitable to accept extension adapter ZLS 101 4x18 mm – bag containing 5 items	ZLS100	2CCF002762R0001	0015603	1	1	95



ZLSP906

Din rail clip

	Type name	ABB IT number	EAN number 761227	Packaging unit	Module	Weight in grams
Din rail clip ZLSP926 and ZLSP928. This item is need if the additional socket will be mounted on a DIN rail. 1 pcs. every 30 cm.	ZLSP937	2CCA212012R0001	498306	Bag of 5		18



ZLSP906

SMISLINE TP plug-in system

Busbars Power Bar System 250A and 40A

250A and 40A busbars / selection table for sockets

Order data busbar 250A	ABB IT number	EAN number 761227	ZLSP908	ZLSP906	Pack unit	Moduls (1 PLE 18mm)	Weight in grams	Busbar length in mm	Order data busbar 40A	ABB IT number	EAN number 761227
ZLSP1250E30	2CCF212100M0030	148 7423	3	1	1	30	366	535	ZLS203E30	2CCF800229R0001	0017669
ZLSP1250E32	2CCF212100M0032	148 7447	4	-	1	32	391	571	ZLS203E32	2CCF800230R0001	0017683
ZLSP1250E34	2CCF212100M0034	148 7461	2	3	1	34	415	607	ZLS203E34	2CCF800231R0001	0017706
ZLSP1250E36	2CCF212100M0036	148 7485	3	2	1	36	439	643	ZLS203E36	2CCF800232R0001	0017720
ZLSP1250E38	2CCF212100M0038	148 7508	4	1	1	38	464	679	ZLS203E38	2CCF800233R0001	0017744
ZLSP1250E40	2CCF212100M0040	148 7522	5	-	1	40	488	715	ZLS203E40	2CCF800234R0001	0017768
ZLSP1250E42	2CCF212100M0042	148 7546	3	3	1	42	513	751	ZLS203E42	2CCF800235R0001	0017782
ZLSP1250E44	2CCF212100M0044	148 7560	4	2	1	44	537	787	ZLS203E44	2CCF800236R0001	0017805
ZLSP1250E46	2CCF212100M0046	148 7584	5	1	1	46	561	823	ZLS203E46	2CCF800237R0001	0017829
ZLSP1250E48	2CCF212100M0048	148 7607	6	-	1	48	586	859	ZLS203E48	2CCF800238R0001	0017843
ZLSP1250E50	2CCF212100M0050	148 7621	4	3	1	50	610	895	ZLS203E50	2CCF800239R0001	0017867
ZLSP1250E52	2CCF212100M0052	148 7645	5	2	1	52	635	932	ZLS203E52	2CCF800240R0001	0017881
ZLSP1250E54	2CCF212100M0054	148 7669	6	1	1	54	659	968	ZLS203E54	2CCF800241R0001	0017904
ZLSP1250E56	2CCF212100M0056	148 7683	7	-	1	56	683	1004	ZLS203E56	2CCF800242R0001	0017928
ZLSP1250E58	2CCF212100M0058	148 7706	5	3	1	58	708	1040	ZLS203E58	2CCF800243R0001	0017942
ZLSP1250E60	2CCF212100M0060	148 7720	6	2	1	60	732	1076	ZLS203E60	2CCF800244R0001	0017973
ZLSP1250E62	2CCF212100M0062	148 7744	7	1	1	62	757	1112	ZLS203E62	2CCF800245R0001	0017997
ZLSP1250E64	2CCF212100M0064	148 7768	8	-	1	64	781	1148	ZLS203E64	2CCF800246R0001	0018017
ZLSP1250E66	2CCF212100M0066	148 7782	6	3	1	66	806	1184	ZLS203E66	2CCF800247R0001	0018031
ZLSP1250E68	2CCF212100M0068	148 7805	7	2	1	68	830	1220	ZLS203E68	2CCF800248R0001	0018055
ZLSP1250E70	2CCF212100M0070	148 7829	8	1	1	70	854	1256	ZLS203E70	2CCF800249R0001	0018079
ZLSP1250E72	2CCF212100M0072	148 7843	9	-	1	72	879	1292	ZLS203E72	2CCF800250R0001	0018093
ZLSP1250E74	2CCF212100M0074	148 7867	7	3	1	74	903	1328	ZLS203E74	2CCF800251R0001	0018116
ZLSP1250E76	2CCF212100M0076	148 7881	8	2	1	76	928	1364	ZLS203E76	2CCF800252R0001	0018130
ZLSP1250E78	2CCF212100M0078	148 7904	9	1	1	78	952	1400	ZLS203E78	2CCF800253R0001	0018154
ZLSP1250E80	2CCF212100M0080	148 7928	10	-	1	80	976	1436	ZLS203E80	2CCF800254R0001	0018185
ZLSP1250E82	2CCF212100M0082	148 7942	8	3	1	82	1001	1472	ZLS203E82	2CCF800255R0001	0018208
ZLSP1250E84	2CCF212100M0084	148 7966	9	2	1	84	1025	1508	ZLS203E84	2CCF800256R0001	0018222
ZLSP1250E86	2CCF212100M0086	148 7980	10	1	1	86	1050	1544	ZLS203E86	2CCF800257R0001	0018246
ZLSP1250E88	2CCF212100M0088	148 8000	11	-	1	88	1074	1580	ZLS203E88	2CCF800258R0001	0018260
ZLSP1250E90	2CCF212100M0090	148 8024	9	3	1	90	1098	1616	ZLS203E90	2CCF800259R0001	0018284
ZLSP1250E92	2CCF212100M0092	148 8048	10	2	1	92	1123	1652	ZLS203E92	2CCF800260R0001	0018307
ZLSP1250E94	2CCF212100M0094	148 8062	11	1	1	94	1147	1688	ZLS203E94	2CCF800261R0001	0018321
ZLSP1250E96	2CCF212100M0096	148 8086	12	-	1	96	1172	1724	ZLS203E96	2CCF800262R0001	0018345
ZLSP1250E98	2CCF212100M0098	148 8109	10	3	1	98	1196	1760	ZLS203E98	2CCF800263R0001	0018369
ZLSP1250E100	2CCF212100M0100	148 8123	11	2	1	100	1220	1796	ZLS203E100	2CCF800264R0001	0017195
ZLSP1250E102	2CCF212100M0102	148 8147	12	1	1	102	1245	1832	ZLS203E102	2CCF800265R0001	0017218
ZLSP1250E104	2CCF212100M0104	148 8161	13	-	1	104	1269	1868	ZLS203E104	2CCF800266R0001	0017232
ZLSP1250E106	2CCF212100M0106	148 8185	11	3	1	106	1294	1904	ZLS203E106	2CCF800267R0001	0017256
ZLSP1250E108	2CCF212100M0108	148 8208	12	2	1	108	1318	1940	ZLS203E108	2CCF800268R0001	0017270

Planning for the incorporation of feeder block and spare places should be taken into account.
The total lengths given above were calculated taking socket spacings and tolerances into account.
For this reason, the indicated busbar length is not necessarily a multiple of 18mm (1 Module).

SMISLINE TP plug-in system

Busbar system 250 A

Direct feed to plug-in circuit-breaker Tmax XT4

The direct feed starter pack solution allows a direct connection from the 250A Power Bar System to the Installation for plug-in circuit-breaker Tmax XT4 Moulded Case Circuit Breaker. Lower part for plug-in for Tmax XT4, 3 pole (1SDA068196R1) or 4 pole (1SDA068198R1) is needed.

For fixed XT4 version a conversion kit for moving part plug-in is needed additional. 3pole (1SDA066282R1) and 4 pole (SDA066283R1).

The solution is built for a vertical design. The additional heat sink part is helpful to reduce the heat on the system.

Direct Feed 250A



Number of poles	32 to 80 3p+N/2 additional bars PE+N
Rated operational voltage (U_e)	690VAC, 440VDC (400V for LA, LB busbars)
Rated insulation voltage (U_i)	690VAC, 1000VDC
IP Code	IP20B
Pollution degree	3 (690Va.c.) 2 (1000Vd.c.)
Rated impulse voltage (U_{imp})	8 kV (L1L2L3N)
Rated current of the assembly (I_{nA})	250A
Rated current of a circuit (I_{nc}): main circuit	Max. 250A
Rated current of Auxiliary circuit	40A
Rated short-time withstand current (I_{cw})	15 kA/100ms Main circuit, 4 kA/50ms Auxiliary circuit
Rated peak withstand current Main circuit (I_{pk})	30 kA
Rated peak withstand current Auxiliary circuit (I_{pk})	6 kA
Rated frequency (f)	50/60Hz
Rated conditional short-circuit current (I_{cc}): see table below	
Ambient air temperature	max. 60°C
Size of CU bars 3P+N+PE	3 x 25 mm (75 mm ²)
Size of CU auxiliary bars La Lb	2 x 5 mm (10 mm ²)
Environmental conditions (damp heat)	1 cycle with 55°C/90...96% and 25°C/95...100%

Voltage (VAC)	Rated conditional short-circuit current (I_{cc})	Incoming current of main busbars (L1, L2, L3, N)	Short circuit protection device (SCPD)
415 V	100 kA	250 A	ABB
690 V	25 kA	250 A	Tmax XT4 250A

Technical data data UL508; Approvals for US and CA: cULus
Direct Feed 250A

SMISLINE TP system for UL 508 – Industrial Control Equipment, CSA C22.2 No. 14 – Industrial Control Equipment UL File E222110	Control Equipment UL File E222110
UL Rated Voltage	600 VAC
UL Rated Current (End Feed)	250A
UL Short Circuit Rating	50 kA (480V), 35 kA (600V) with XT4 250A

SMISSLINE TP plug-in system

Direct Feed Touch proof 3L and 3LN

Power Bar System 250 A

Ordering data

	Solutions available	Direct feed length incl. Socket end piece mm	Type name	ABB IT number	EAN number 761227	Pack unit	Weight 1 piece kg
	32PLE 3L left	742	ZLSP960-3L-32-L	2CCG000155R0001	1507022	1	2,868
	32PLE 3LN left	742	ZLSP960-3LN-32-L	2CCG000156R0001	1507039	1	4,258
	32PLE 3L right	742	ZLSP960-3L-32-R	2CCG000157R0001	1507046	1	3,258
	32PLE 3LN right	742	ZLSP960-3LN-32-R	2CCG000158R0001	1507053	1	4,258
	40PLE 3L left	886	ZLSP960-3L-40-L	2CCG000159R0001	1507060	1	3,308
	40PLE 3LN left	886	ZLSP960-3LN-40-L	2CCG000160R0001	1507077	1	4,796
	40PLE 3L right	886	ZLSP960-3L-40-R	2CCG000161R0001	1507084	1	3,308
	40PLE 3LN right	886	ZLSP960-3LN-40-R	2CCG000162R0001	1507091	1	4,796
	48PLE 3L left	1030	ZLSP960-3L-48-L	2CCG000163R0001	1507107	1	3,747
	48PLE 3LN left	1030	ZLSP960-3LN-48-L	2CCG000164R0001	1507114	1	5,333
	48PLE 3L right	1030	ZLSP960-3L-48-R	2CCG000165R0001	1507121	1	3,747
	48PLE 3LN right	1030	ZLSP960-3LN-48-R	2CCG000166R0001	1507138	1	5,333
	56PLE 3L left	1174	ZLSP960-3L-56-L	2CCG000167R0001	1507145	1	4,187
	56PLE 3LN left	1174	ZLSP960-3LN-56-L	2CCG000168R0001	1507152	1	5,871
	56PLE 3L right	1174	ZLSP960-3L-56-R	2CCG000169R0001	1507169	1	4,187
	56PLE 3LN right	1174	ZLSP960-3LN-56-R	2CCG000170R0001	1507176	1	5,871
	64PLE 3L left	1318	ZLSP960-3L-64-L	2CCG000171R0001	1507183	1	4,627
	64PLE 3LN left	1318	ZLSP960-3LN-64-L	2CCG000172R0001	1507190	1	6,408
	64PLE 3L right	1318	ZLSP960-3L-64-R	2CCG000173R0001	1507206	1	4,627
	64PLE 3LN right	1318	ZLSP960-3LN-64-R	2CCG000174R0001	1507213	1	6,408
	66PLE 3L left	1354	ZLSP960-3L-66-L	2CCG000175R0001	1507220	1	4,746
	66PLE 3LN left	1354	ZLSP960-3LN-66-L	2CCG000176R0001	1507237	1	6,551
	66PLE 3L right	1354	ZLSP960-3L-66-R	2CCG000177R0001	1507244	1	4,746
	68PLE 3LN right	1390	ZLSP960-3LN-66-R	2CCG000178R0001	1507251	1	6,551
	68PLE 3L left	1390	ZLSP960-3L-68-L	2CCG000179R0001	1507268	1	4,853
	68PLE 3LN left	1390	ZLSP960-3LN-68-L	2CCG000180R0001	1507275	1	6,683
	68PLE 3L right	1390	ZLSP960-3L-68-R	2CCG000181R0001	1507282	1	4,853
70PLE 3LN right	1426	ZLSP960-3LN-68-R	2CCG000182R0001	1507299	1	6,683	
70PLE 3L left	1426	ZLSP960-3L-70-L	2CCG000183R0001	1507305	1	4,96	
70PLE 3LN left	1426	ZLSP960-3LN-70-L	2CCG000184R0001	1507312	1	6,814	
70PLE 3L right	1426	ZLSP960-3L-70-R	2CCG000185R0001	1507329	1	4,96	
72PLE 3LN right	1462	ZLSP960-3LN-70-R	2CCG000186R0001	1507336	1	6,814	
72PLE 3L left	1462	ZLSP960-3L-72-L	2CCG000187R0001	1507343	1	5,067	
72PLE 3LN left	1462	ZLSP960-3LN-72-L	2CCG000188R0001	1507350	1	6,946	
72PLE 3L right	1462	ZLSP960-3L-72-R	2CCG000189R0001	1507367	1	5,067	
74PLE 3LN right	1498	ZLSP960-3LN-72-R	2CCG000190R0001	1507374	1	6,946	
74PLE 3L left	1498	ZLSP960-3L-74-L	2CCG000191R0001	1507381	1	5,185	
74PLE 3LN left	1498	ZLSP960-3LN-74-L	2CCG000192R0001	1507398	1	7,089	
74PLE 3L right	1498	ZLSP960-3L-74-R	2CCG000193R0001	1507404	1	5,185	
76PLE 3LN right	1534	ZLSP960-3LN-74-R	2CCG000194R0001	1507411	1	7,089	
76PLE 3L left	1534	ZLSP960-3L-76-L	2CCG000195R0001	1507428	1	5,293	
76PLE 3LN left	1534	ZLSP960-3LN-76-L	2CCG000196R0001	1507435	1	7,22	
76PLE 3L right	1534	ZLSP960-3L-76-R	2CCG000197R0001	1507442	1	5,293	
78PLE 3LN right	1570	ZLSP960-3LN-76-R	2CCG000198R0001	1507459	1	7,22	
78PLE 3L left	1570	ZLSP960-3L-78-L	2CCG000644R0001	1507466	1	5,4	
78PLE 3LN left	1570	ZLSP960-3LN-78-L	2CCG000200R0001	1507473	1	7,352	
78PLE 3L right	1570	ZLSP960-3L-78-R	2CCG000645R0001	1507480	1	5,4	
80PLE 3LN right	1606	ZLSP960-3LN-78-R	2CCG000202R0001	1507497	1	7,352	
80PLE 3L left	1606	ZLSP960-3L-80-L	2CCG000203R0001	1507503	1	5,507	
80PLE 3LN left	1606	ZLSP960-3LN-80-L	2CCG000204R0001	1507510	1	7,483	
80PLE 3L right	1606	ZLSP960-3L-80-R	2CCG000205R0001	1507527	1	5,507	
80PLE 3LN right	1606	ZLSP960-3LN-80-R	2CCG000206R0001	1507534	1	7,483	

Left Version



Right Version



Busbar system 250 A

Direct feed Accessories

At the first 12 module positions close to the XT4 a derating of 0,76 shall be applied.

For the other modules the derating is according the data from the technical catalogue for MCB, RCD, RCBOs. The specific deratings for devices for influence of adjacent poles and ambient temperature must be still carefully attended in any case.

Ordering data

	Solutions available	EAN number 761227	Type name	ABB IT number	Weight in grams	Pack unit
	Heatsink 3L	1512446	ZLSP960HS-3L	2CCG000736R0001	197	1
	Heatsink 3LN	1512453	ZLSP960HS-3LN	2CCG000739R0001	262	1
	Screws (only for replacement, all screws are included in direct feed)	1508401	ZLSP960screw	2CCG000361R0001	55	-
						
						

SMISSLINE TP plug-in system

One system with many options

SMISSLINE TP protective devices with plug-in technology – the individual way in switchgear technology

Five modern protective devices in the same design are simply plugged onto a busbar system. The complex feed-in and connection work is already done. In addition to this time and cost savings, it is crucial to be able to quickly and easily replace equipment. Third-party devices can be integrated into the busbar system by using adapters. The system was developed for commercial and industrial switchgear technology. Installation and wiring times can be greatly reduced by using the directly attachable system.

Together with the ABB STRIEBEL & JOHN switchgear system, optimum space utilization, easy changes and expansion of the switch cabinet and its installations can be achieved thanks to horizontal or vertical installation options. The individual components are coordinated with each other, such as the length of the plug-in socket and the modular components of the switch cabinets. Of course, mixed installation options of conventional modular devices can also easily be realized, such as pro M Compact. The configured ABB STRIEBEL & JOHN expansion products make this possible.

A powerful 250 A system is now available with the SMISSLINE TP Power Bar system. The busbars have a rated amperage of 250 A and therefore allow end feed of 250 A, which significantly expands the system's range of application.

SMISSLINE TP and ABB STRIEBEL & JOHN – the cabinet system at a glance:

- Flexible and modular
- Freedom in concept and arrangement
- Time saved during planning and execution
- Quick adaptation when expanding
- Allows for the load-free connection and disconnection of devices and components under voltage without the need for additional personal protective equipment to guard against electrical hazards
- Coordinated product components
- SMISSLINE TP modules can be combined with other ABB STRIEBEL & JOHN distribution panels and modules

Small cause, large effect

As the world's first pluggable socket system, SMISSLINE TP allows devices and components to be snapped on and off, load-free and under voltage, without having to take additional personal protective measures. It opens up to a completely new prospects when it comes to installation, operation and flexibility.

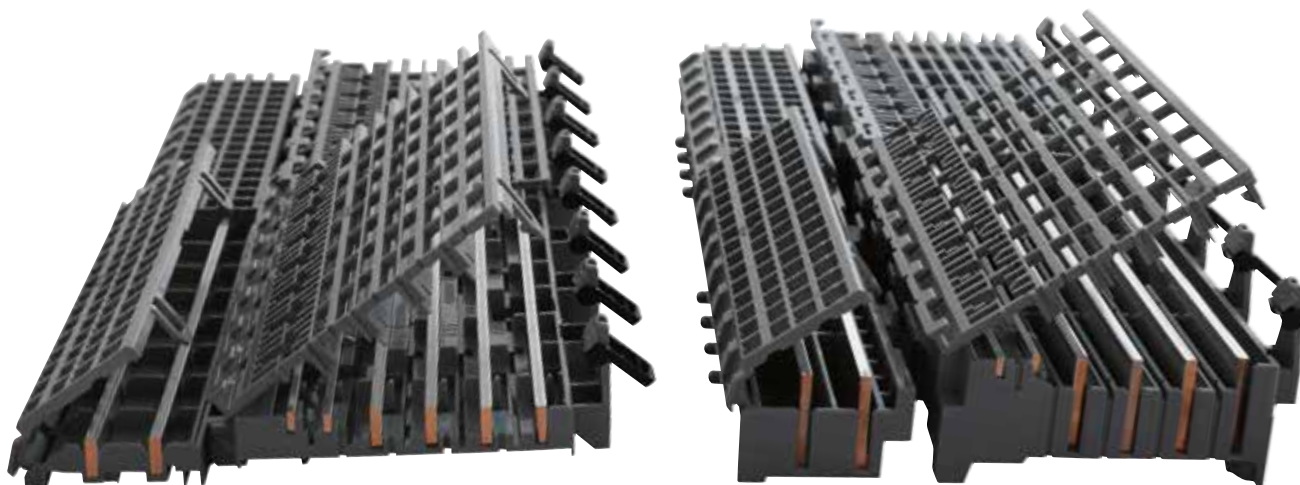

SMISLINE TP plug-in system

One system with many options



—
01
The outlet wiring is done directly on the installed devices. The N and PE terminals are assigned to the devices accordingly. The outlet cables are affixed in a mesh cable tray neatly and clearly arranged.

—
02
A cabinet equipped with modules for accommodating SMISLINE TP devices with third-party device adapters and pro M modular devices.

—
01



—
02



SMISLINE TP plug-in system

CombiLine modules view

Horizontal modules are suitable for mounting on WR or EDF profiles. From cabinet depth of 215 mm. The WR or EDF mounting frame must be ordered separately.

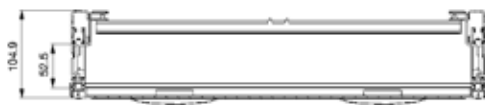

Sectional drawing from above,
example MC203HS

Front view



Vertical modules are suitable for mounting in cabinets from a depth of 275 mm. The mounting frame must be ordered separately. Cable laying grid is included for cable fixing. With DIN rail for PE/N disconnect terminals.

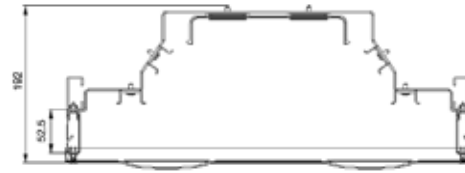

Sectional drawing from above,
example MC203VS

Front view



SMISSLINE TP 125 A interior expansion with CombiLine

Options for assembly in an enclosure

For a horizontal device arrangement, the DIN rail can be set in conjunction with mounting adapters. The Busbar systems cannot be through-connected from one panel to the next. The DIN rail is mounted to a 2-stage bracket (in front upon delivery). The front position is for the plug-in socket assembly. The SMISSLINE TP devices will directly be mounted. The back position is for mounting the socket bases for devices with DIN-rail adapters.

For a vertical device arrangement, the existing cover holders are replaced with cover holders ED137P4 with spacers ED135P4 in conjunction with mounting adapters. In addition, a cover raising frame is required, so that there is more space under the cover. All devices using mounting adapters are to be arranged under a separate cover. Cable lying grids are installed for modules with a vertical device arrangement in order to attach the lines. The DIN rails are designed to be equipped with the SMISSLINE TP socket base rows. It is also possible to connect the SMISSLINE TP additional socket (N/PE terminals).

Horizontal device arrangement



Vertical device arrangement



Important: It is recommended to provide at least a 150 mm high terminal or wiring space on the cable entry side.

SMISLINE TP 125 A interior expansion with CombiLine

For horizontal and vertical device arrangement



MC203HS

MC303HS

- SMISLINE TP modules for horizontal device arrangement
- Extension with DIN rails 35 x 15 mm
- Distance between DIN rails 150 mm
- From 3 panels on the DIN rails are equipped, with additional stabilization rail
- Important: The SMISLINE TP busbar system cannot be through-connected from one module to the next
- The mounting frame must be ordered separately

Height OH	Width		Socket base length			From cabinet depth mm	FLATPACK not installed		MOUNTED and installed in the cabinet		
	mm	PW mm	PLE	EDF ¹	WR ²		Type	Order code	Type	Order code	
2	300	2	500	2 x 22	●	●	215	MBC202HS	2CPX042155R9999	MC202HS	2CPX042132R9999
	300	3	750	2 x 36	●	●	215	MBC302HS	2CPX042156R9999	MC302HS	2CPX042133R9999
3	450	2	500	3 x 22	●	●	215	MBC203HS	2CPX042157R9999	MC203HS	2CPX042134R9999
	450	3	750	3 x 36	●	●	215	MBC303HS	2CPX042158R9999	MC303HS	2CPX042135R9999
4	600	2	500	4 x 22	●	●	215	MBC204HS	2CPX042159R9999	MC204HS	2CPX042136R9999
	600	3	750	4 x 36	●	●	215	MBC304HS	2CPX042160R9999	MC304HS	2CPX042137R9999
5	750	2	500	5 x 22	●	●	215	MBC205HS	2CPX042161R9999	MC205HS	2CPX042138R9999
	750	3	750	5 x 36	●	●	215	MBC305HS	2CPX042162R9999	MC305HS	2CPX042139R9999



MC103VS

MC203VS

MC305VS

- SMISLINE TP modules for vertical device arrangement
- Extension with DIN rails 35 x 15 mm
- The DIN rails in the back are designed for standard N (N disconnect terminals) and PE terminals
- A cable laying grid is included for cable fixing
- The DIN rails and cable laying grids are flush with the module
- Important: Vertical modules cannot be mounted directly on central support rails and horizontal cross members
- The mounting frame must be ordered separately

3	450	1	250	1 x 22	●	●	275	MBC103VS	2CPX042163R9999	MC103VS	2CPX042140R9999
	450	2	500	2 x 22	●	●	275	MBC203VS	2CPX042164R9999	MC203VS	2CPX042141R9999
4	600	1	250	1 x 30	●	●	275	MBC104VS	2CPX042165R9999	MC104VS	2CPX042142R9999
	600	2	500	2 x 30	●	●	275	MBC204VS	2CPX042166R9999	MC204VS	2CPX042143R9999
	600	3	750	2 x 30	●	●	275	-	-	MC304VS	2CPX042913R9999
5	750	1	250	1 x 38	●	●	275	MBC105VS	2CPX042167R9999	MC105VS	2CPX042144R9999
	750	2	500	2 x 38	●	●	275	MBC205VS	2CPX042168R9999	MC205VS	2CPX042145R9999
	750	3	750	2 x 38	●	●	275	MBC305VS	2CPX042911R9999	MC305VS	2CPX042910R9999

¹ Expansion on EDF mounting frame ² Expansion on WR mounting frame

SMISLINE TP Power Bar 250 A interior expansion with CombiLine

For horizontal and vertical device arrangement



MC203HS



MC303HS

- SMISLINE TP modules for horizontal device arrangement
- Extension with DIN rails 35 x 15 mm
- Distance between DIN rails 150 mm
- From 3 panels on the DIN rails are equipped, with additional stabilization rail
- Important: The SMISLINE TP busbar system cannot be through-connected from one module to the next
- The mounting frame must be ordered separately

Height OH	Width		Socket base length			Down Cabinet depth	FLATPACK not installed		MOUNTED and installed in the cabinet		
	mm	PW mm	PLE	EDF*1	WR*2		Type	Item number	Type	Item number	
2	300	2	500	2 x 22	●	●	215	MBC202HS	2CPX042155R9999	MC202HS	2CPX042132R9999
	300	3	750	2 x 36	●	●	215	MBC302HS	2CPX042156R9999	MC302HS	2CPX042133R9999
3	450	2	500	3 x 22	●	●	215	MBC203HS	2CPX042157R9999	MC203HS	2CPX042134R9999
	450	3	750	3 x 36	●	●	215	MBC303HS	2CPX042158R9999	MC303HS	2CPX042135R9999
4	600	2	500	4 x 22	●	●	215	MBC204HS	2CPX042159R9999	MC204HS	2CPX042136R9999
	600	3	750	4 x 36	●	●	215	MBC304HS	2CPX042160R9999	MC304HS	2CPX042137R9999
5	750	2	500	5 x 22	●	●	215	MBC205HS	2CPX042161R9999	MC205HS	2CPX042138R9999
	750	3	750	5 x 36	●	●	215	MBC305HS	2CPX042162R9999	MC305HS	2CPX042139R9999



MC203VS



MC305VS

- SMISLINE TP Power Bar 250 A modules for vertical device arrangement
- Extension with DIN rails 35 x 15 mm
- The DIN rails in the back are designed for standard N (N disconnect terminals) and PE terminals
- A cable laying grid is included for cable fixing
- The DIN rails and cable laying grids are flush with the module
- Important: Vertical modules cannot be mounted directly on central support rails and horizontal cross members.
- The mounting frame must be ordered separately

3	450	2	500	2 x 22	●	●	275	MBC203VP	2CPX043369R9999	MC203VP	2CPX043349R9999
4	600	2	500	2 x 30	●	●	275	MBC204VP	2CPX043371R9999	MC204VP	2CPX043351R9999
	600	3	750	2 x 30	●	●	275	MBC304VP	2CPX043376R9999	MC304VP	2CPX043374R9999
5	750	2	500	2 x 38	●	●	275	MBC205VP	2CPX043373R9999	MC205VP	2CPX043353R9999
	750	3	750	2 x 38	●	●	275	MBC305VP	2CPX043377R9999	MC305VP	2CPX043375R9999

*1 Expansion on EDF mounting frame *2 Expansion on WR mounting frame

SMISLINE TP plug-in system

Cable laying grids, DIN rails, fixing brackets



ZW430



ZW436

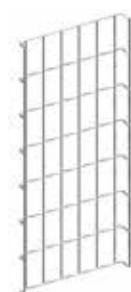

ZW470



ZW257



ZW359



ED73



ED52



ZX399



ZW590



ZW592

Article	Use for...	VE/pc.	Type	Order code
Cable laying grids width 100 mm				
Length				
450 mm	M(B)C103VS	1	ZW430	2CPX042170R9999
600 mm	M(B)C104VS	1	ZW431	2CPX042171R9999
750 mm	M(B)C105VS	1	ZW432	2CPX042172R9999
Cable laying grids width 200 mm				
Length				
450 mm	M(B)C203VS	1	ZW436	2CPX042176R9999
600 mm	M(B)C204VS	1	ZW437	2CPX042177R9999
750 mm	M(B)C205VS	1	ZW438	2CPX042178R9999
3000 mm	-	1	ZW460	2CPX073256R9999
Cable laying grids width 300 mm				
Length				
3000 mm	-	1	ZW470	2CPX073257R9999
Fixing bracket for cable laying grids				
SMISLINE TP system 125 A				
For cabinet depth from 275 mm				
1 panel wide	M(B)C1...VS	1	ZW257	2CPX042182R9999
2 panel wide	M(B)C2...VS	1	ZW258	2CPX042183R9999
3 panel wide	M(B)C3...VS	1	ZW359	2CPX042912R9999
Vertical DIN rails				
For module height				
450 mm	M(B)C...03VS	1	ED73	2CPX042184R9999
600 mm	M(B)C...04VS	1	ED74	2CPX042185R9999
750 mm	M(B)C...05VS	1	ED75	2CPX042186R9999
Horizontal DIN rails				
2 panel wide	M(B)C2...HS	1	ED52	2CPX039252R9999
3 panel wide	M(B)C3...HS	1	ED53	2CPX039253R9999
Fixing bracket				
For horizontal DIN rails, 1 set left / right				
M(B)C...HS		1	ZX399	2CPX062669R9999
Mounting bracket for cable laying grids				
Power Bar 250 A				
For cabinet depth from 275 mm				
1 panel wide	M(B)C1...VP	1	ZW590	2CPX042922R9999
2 panel wide	M(B)C2...VP	1	ZW591	2CPX042923R9999
3 panel wide	M(B)C3...VP	1	ZW592	2CPX042924R9999

SMISLINE TP plug-in system

Cover holders, panel connectors, raising frames



ED137P4



ED138P12



ED135P4



ED50P12



ED30P2



ED213

Article	VE/pc.	Type	Order code
Cover holder 45 mm high, required when changing the cover height when installing mounting adapters in the cover height when installing vertical modules	4	ED137P4	2CPX062600R9999
Cover holder 52.5 mm high	12	ED138P12	2CPX062602R9999
	40	ED138P40	2CPX062603R9999
Space To extend the cover holder by 25 mm	4	ED135P4	2CPX062610R9999
90 degree press and turn closure	12	ED50P12	2CPX062337R9999
Panel connector Used to join distribution panels or combination sets with each other up to a maximum Overall height 5 (9 RE)	2	ED30P2	2CPX062302R9999
Raising frame for covers Required to change the cover height when installing mounting device adapters in vertical modules			
External dimensions (H x W)			
450 x 250 mm	1	ED213	2CPX062783R9999
600 x 250 mm	1	ED214	2CPX062784R9999
750 x 250 mm	1	ED215	2CPX062785R9999
450 x 500 mm	1	ED223	2CPX062788R9999
600 x 500 mm	1	ED224	2CPX062789R9999
750 x 500 mm	1	ED225	2CPX062790R9999
450 x 750 mm	1	ED233	2CPX062793R9999
600 x 750 mm	1	ED234	2CPX062794R9999
750 x 750 mm	1	ED235	2CPX062795R9999

SMISLINE TP plug-in system

Plastic cover horizontal



AS22H



AS32H

Article	Use for...	VE/pc.	Type	Order code
Plastic cover horizontal				
With device slot, 2 panel wide				
External dimensions (H x W)				
300 x 500 mm	M(B)C202HS	1	AS22H	2CPX062764R9999
450 x 500 mm	M(B)C203HS	1	AS23H	2CPX062765R9999
600 x 500 mm	M(B)C204HS	1	AS24H	2CPX062766R9999
750 x 500 mm	M(B)C205HS	1	AS25H	2CPX062767R9999
Plastic cover horizontal				
With device slot, 3 panel wide				
External dimensions (H x W)				
300 x 750 mm	M(B)C302HS	1	AS32H	2CPX062768R9999
450 x 750 mm	M(B)C303HS	1	AS33H	2CPX062769R9999
600 x 750 mm	M(B)C304HS	1	AS34H	2CPX062770R9999
750 x 750 mm	M(B)C305HS	1	AS35H	2CPX062771R9999

SMISLINE TP plug-in system

Plastic cover vertical



AS13V



AS23V



AS35V

Article	Use for...	VE/pc.	Type	Order code
Plastic cover vertical				
With device slot, 1 panel wide				
External dimensions (H x W)				
450 x 250 mm	M(B)C103VS	1	AS13V	2CPX062772R9999
600 x 250 mm	M(B)C104VS	1	AS14V	2CPX062773R9999
750 x 250 mm	M(B)C105VS	1	AS15V	2CPX062774R9999
Plastic cover vertical				
With device slot, 2 panel wide				
External dimensions (H x W)				
450 x 500 mm	M(B)C203VS	1	AS23V	2CPX062775R9999
600 x 500 mm	M(B)C204VS	1	AS24V	2CPX062776R9999
750 x 500 mm	M(B)C205VS	1	AS25V	2CPX062777R9999
Plastic cover vertical				
With device slot, 3 panel wide				
External dimensions (H x W)				
750 x 750 mm	M(B)C305VS	1	AS35V	2CPX062796R9999

SMISSLINE TP plug-in system

Socket calculation with e-Design and Panel Design Configurator

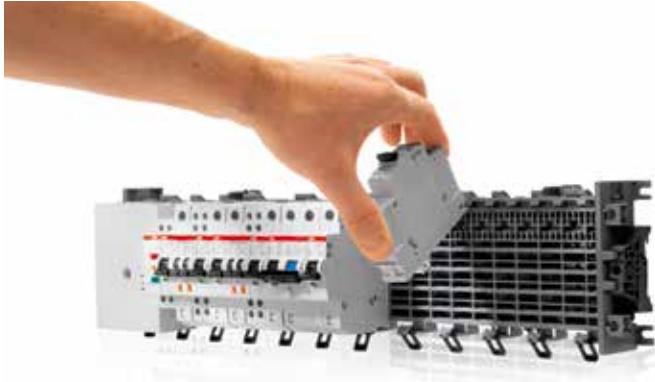

In our Panel Design Configurator: SMISSLINE TP Designer

The SMISSLINE TP Designer is integrated in the StriePlan basic version. StriePlan thus offers a simple configuration and calculation of the SMISSLINE TP pluggable socket system. The SMISSLINE TP Designer makes it possible to select and configure ABB SMISSLINE TP products in a graphic environment:

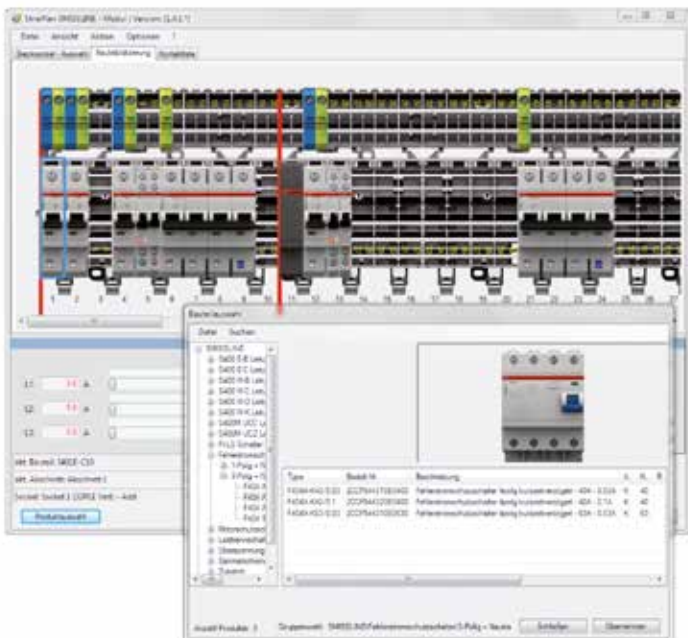

Advantages at a glance:

- Complete integration in StriePlan
- Cabinet and module selection possible in StriePlan specifically for SMISSLINE TP plug-in socket
- Graphic equipping of the plug-in socket
- Complete selection of SMISSLINE TP products
- Configuration of accessories
- Automatic equipping
- Supported placement of the feed-in

Information about:

- Incoming and outgoing current
- Control and display of the units, the current and the power loss
- Technical specifications of the devices, including price calculation (in StriePlan)
- Print or export (in StriePlan) of BOMs, design drawings or tender texts

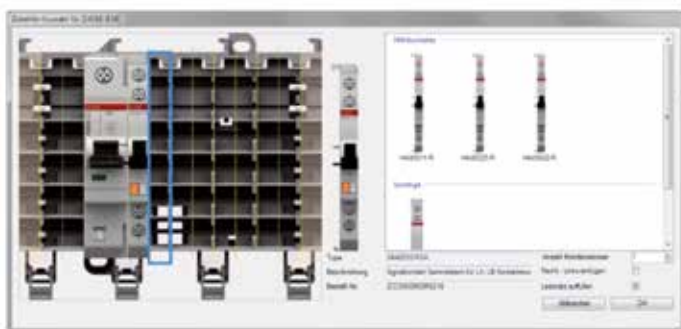

Accessories dialog

The combination of devices and additional components (e.g.: auxiliary and signal contacts) is comprehensively supported

- Automatic insertion of component combinations
- Automatic component selection for right/left positioning

SMISLINE TP plug-in system

Comparison of starting package with plug-in socket in individual parts

Solution of plug-in socket starting package

The plug-in socket and busbars are already assembled. Different lengths are available. The assignment of the appropriate ABB STRIEBEL & JOHN modules to the starting packages is described on the following pages – planning aid for SMISLINE TP plug-in socket.

The detailed solutions of the plug-in socket and starting package are evident in the technical catalog SMISLINE TP or the catalog low-voltage material of ABB-Stotz Kontakt and ABB STRIEBEL & JOHN.



Solution of plug-in socket in individual parts

You can assemble plug-in sockets, busbars and socket end pieces on your own from the individual components. Plug-in sockets with 8 units (144 mm) and 6 units (108 mm) can be selected and assembled in any number up to 110 PLE.

The busbars can be ordered in the length of 1979 mm and shortened accordingly. It is also possible to order busbars from ABB already cut to length.



SMISLINE TP plug-in system

Assignment of CombiLine modules

Information about planning

When positioning incoming terminal blocks under cover joints, lower feed-in blocks ZLS228 or ZLS229 are to be used.

Vertical modules cannot be mounted directly on central support rails and horizontal cross members.

SMISLINE TP plug-in system

Starter kit or socket base in individual parts

Socket base starter kit			Socket base in individual parts			
Unit	Type	Order code	Unit	Space units	Type	Order code
1	ZLS905E22-3L	2CCA183102R0001	2	8	ZLS908	2CCA183030R0001
			1	6	ZLS906	2CCA183035R0001
			1	-	ZLS920 (end piece)	2CCA183017R0001
1	ZLS905E22-3LN*	2CCA183103R0001	3/4*	-	ZLS201E22 (Copper rail)	2CCF800169R0001
1	ZLS905E30-3L	2CCA183110R0001	3	8	ZLS908	2CCA183030R0001
			1	6	ZLS906	2CCA183035R0001
			1	-	ZLS920 (end piece)	2CCA183017R0001
1	ZLS905E30-3LN*	2CCA183111R0001	3/4*	-	ZLS201E38 (Copper rail)	2CCF800173R0001
1	ZLS905E38-3L	2CCA183118R0001	4	8	ZLS908	2CCA183030R0001
			1	6	ZLS906	2CCA183035R0001
			1	-	ZLS920 (end piece)	2CCA183017R0001
1	ZLS905E38-3LN*	2CCA183119R0001	3/4*	-	ZLS201E46 (Copper rail)	2CCF800177R0001
1	ZLS905E46-3L	2CCA183126R0001	5	8	ZLS908	2CCA183030R0001
			1	6	ZLS906	2CCA183035R0001
	ZLS905E46-3LN*	2CCA183127R0001	1	-	ZLS920 (end piece)	2CCA183017R0001
1	ZLS905E72-3L	2CCA183152R0001	9	8	ZLS908	2CCA183030R0001
			1	-	ZLS920 (end piece)	2CCA183017R0001
1	ZLS905E72-3LN*	2CCA183153R0001	3/4*	-	ZLS201E72 (Copper rail)	2CCF800190R0001

* For version with N (4-pole)

Information about planning

Additional starter kit with AB-bus bar on demand.

SMISLINE TP plug-in system

Assignment of CombiLine modules

Information about planning

When positioning incoming terminal blocks under cover joints, lower feed-in blocks ZLS228 or ZLS229 are to be used.

Vertical modules cannot be mounted directly on central support rails and horizontal cross members.

SMISLINE TP plug-in system

Starter kit or socket base in individual parts

Socket base starter kit			Socket base in individual parts			
Unit	Type	Order code	Unit	Space units	Type	Order code
2	ZLS905E22-3L	2CCA183102R0001	4	8	ZLS908	2CCA183030R0001
			2	6	ZLS906	2CCA183035R0001
			2	-	ZLS920 (end piece)	2CCA183017R0001
2	ZLS905E22-3LN*	2CCA183103R0001	6/8*	-	ZLS201E22 (copper rail)	2CCF800165R0001
2	ZLS905E30-3L	2CCA183110R0001	6	8	ZLS908	2CCA183030R0001
			2	6	ZLS906	2CCA183035R0001
			2	-	ZLS920 (end piece)	2CCA183017R0001
2	ZLS905E30-3LN*	2CCA183111R0001	6/8*	-	ZLS201E30 (copper rail)	2CCF800169R0001
2	ZLS905E38-3L	2CCA183118R0001	8	8	ZLS908	2CCA183030R0001
			2	6	ZLS906	2CCA183035R0001
			2	-	ZLS920 (end piece)	2CCA183017R0001
2	ZLS905E38-3LN*	2CCA183119R0001	6/8*	-	ZLS201E38 (copper rail)	2CCF800173R0001
2	ZLS905E46-3L	2CCA183126R0001	10	8	ZLS908	2CCA183030R0001
			2	6	ZLS906	2CCA183035R0001
			2	-	ZLS920 (end piece)	2CCA183017R0001
2	ZLS905E46-3LN*	2CCA183127R0001	6/8*	-	ZLS201E46 (copper rail)	2CCF800177R0001
2	ZLS905E72-3L	2CCA183152R0001	18	8	ZLS908	2CCA183030R0001
			2	-	ZLS920 (end piece)	2CCA183017R0001
2	ZLS905E72-3LN*	2CCA183153R0001	6/8*	-	ZLS201E72 (copper rail)	2CCF800190R0001

* For version with N (4-pole)

Information about planning

Additional starter kit with AB-bus bar on demand.

SMISLINE TP plug-in system

Assignment of CombiLine modules

Information about planning

For modules of 3 panel width the incoming terminal block serves as centre supply.

SMISLINE TP plug-in system

Starter kit or socket base in individual parts

Socket base starter kit			Socket base in individual parts			
Unit	Type	Order code	Unit	Space units	Type	Order code
2	ZLS905E22-3L	2CCA183102R0001	4	8	ZLS908	2CCA183030R0001
			2	6	ZLS906	2CCA183035R0001
			2	-	ZLS920 (end piece)	2CCA183017R0001
2	ZLS905E22-3LN*	2CCA183103R0001	6/8*	-	ZLS201E22 (copper rail)	2CCF800165R0001
3	ZLS905E22-3L	2CCA183102R0001	6	8	ZLS908	2CCA183030R0001
			3	6	ZLS906	2CCA183035R0001
			3	-	ZLS920 (end piece)	2CCA183017R0001
3	ZLS905E22-3LN*	2CCA183103R0001	9/12*	-	ZLS201E22 (copper rail)	2CCF800165R0001
4	ZLS905E22-3L	2CCA183102R0001	8	8	ZLS908	2CCA183030R0001
			4	6	ZLS906	2CCA183035R0001
			4	-	ZLS920 (end piece)	2CCA183017R0001
4	ZLS905E22-3LN*	2CCA183103R0001	12/16*	-	ZLS201E22 (copper rail)	2CCF800165R0001
5	ZLS905E22-3L	2CCA183102R0001	10	8	ZLS908	2CCA183030R0001
			5	6	ZLS906	2CCA183035R0001
			5	-	ZLS920 (end piece)	2CCA183017R0001
5	ZLS905E22-3LN*	2CCA183103R0001	15/20*	-	ZLS201E22 (copper rail)	2CCF800165R0001
2	ZLS905E36-3L	2CCA183116R0001	6	8	ZLS908	2CCA183030R0001
			4	6	ZLS906	2CCA183035R0001
			2	-	ZLS920 (end piece)	2CCA183017R0001
2	ZLS905E36-3LN*	2CCA183117R0001	6/8*	-	ZLS201E36 (copper rail)	2CCF800172R0001
3	ZLS905E36-3L	2CCA183116R000	9	8	ZLS908	2CCA183030R0001
			6	6	ZLS906	2CCA183035R0001
			3	-	ZLS920 (end piece)	2CCA183017R0001
3	ZLS905E36-3LN*	2CCA183117R0001	9/12*	-	ZLS201E36 (copper rail)	2CCF800172R0001
4	ZLS905E36-3L	2CCA183116R000	12	8	ZLS908	2CCA183030R0001
			8	6	ZLS906	2CCA183035R0001
			4	-	ZLS920 (end piece)	2CCA183017R0001
4	ZLS905E36-3LN*	2CCA183117R0001	12/16*	-	ZLS201E36 (copper rail)	2CCF800172R0001
5	ZLS905E36-3L	2CCA183116R000	15	8	ZLS908	2CCA183030R0001
			10	6	ZLS906	2CCA183035R0001
			5	-	ZLS920 (end piece)	2CCA183017R0001
5	ZLS905E36-3LN*	2CCA183117R0001	15/20*	-	ZLS201E36 (copper rail)	2CCF800172R0001

* For version with N (4-pole)

Information about planning

Additional starter kit with AB-bus bar on demand.

SMISLINE TP plug-in system

Assignment of CombiLine modules

Information about planning

When positioning incoming terminal blocks under cover joints, lower feed-in blocks ZLS228 or ZLS229 are to be used.

Vertical modules cannot be mounted directly on central support rails and horizontal cross members.

SMISLINE TP plug-in system

Starter kit or socket base in individual parts

Socket base starter kit			Socket base in individual parts			
Unit	Type	Order code	Unit	Space units	Type	Order code
-	-	-	-	-	-	-
-	-	-	-	-	-	-
-	-	-	-	-	-	-
2	ZLSP950E30-3L	2CCF212200A0001	6	8	ZLSP908	2CCF212052A0001
			2	6	ZLSP906	2CCF212053A0001
			2	-	ZLSP920	2CCF212082A0001 socket
2	ZLS905E30-3LN*	2CCF212300A0001	6/8*	-	ZLSP1250E30	2CCF212100M0030
2	ZLSP950E38-3L	2CCF212204A0001	8	8	ZLSP908	2CCF212052A0001
			2	6	ZLSP906	2CCF212053A0001
			2	-	ZLSP920	2CCF212082A0001 socket
2	ZLSP950E38-3LN*	2CCF212304A0001	6/8*	-	ZLSP1250E38	2CCF212100M0038
2	ZLSP950E46-3L	2CCF212208A0001	10	8	ZLSP908	2CCF212052A0001
			2	6	ZLSP906	2CCF212053A0001
			2	-	ZLSP920	2CCF212082A0001 socket
2	ZLSP950E46-3LN*	2CCF212308A0001	6/8*	-	ZLSP1250E46	2CCF212100M0046
2	ZLSP950E72-3L	2CCF212221A0001	18	8	ZLSP908	2CCF212052A0001
			2	-	ZLSP906	2CCF212053A0001
2	ZLSP950E72-3LN*	2CCF212321A0001	6/8*	-	ZLSP920	2CCF212082A0001 socket
				-	ZLSP1250E72	2CCF212100M0072

* For version with N (4-pole)

Information about planning

Additional starter kit with AB-bus bar on demand.

SMISLINE TP plug-in system

Assignment of CombiLine modules

Information about planning

For modules of 3 panel width the incoming terminal block serves as centre supply.

SMISLINE TP plug-in system

Starter kit or socket base in individual parts

Socket base starter kit			Socket base in individual parts			
Unit	Type	Order code	Unit	Space units	Type	Order code
2	ZLSP950E36-3L	2CCF212203A0001	6	8	ZLSP908	2CCF212052A0001
			4	6	ZLSP906	2CCF212053A0001
			2	-	ZLSP920	2CCF212082A0001 socket
2	ZLSP950E36-3LN*	2CCF212303A0001	6/8*	-	ZLSP1250E36	2CCF212100M0036
3	ZLSP950E36-3L	2CCF212203A0001	9	8	ZLSP908	2CCF212052A0001
			6	6	ZLSP906	2CCF212053A0001
			3	-	ZLSP920	2CCF212082A0001 socket
3	ZLS905E36-3LN*	2CCF212303A0001	9/12*	-	ZLSP1250E36	2CCF212100M0036
4	ZLSP950E36-3L	2CCF212203A0001	12	8	ZLSP908	2CCF212052A0001
			8	6	ZLSP906	2CCF212053A0001
			4	-	ZLSP920	2CCF212082A0001 socket
4	ZLSP950E36-3LN*	2CCF212303A0001	12/16*	-	ZLSP1250E36	2CCF212100M0036
5	ZLSP950E36-3L	2CCF212203A0001	15	8	ZLSP908	2CCF212052A0001
			10	6	ZLSP906	2CCF212053A0001
			5	-	ZLSP920	2CCF212082A0001 socket
5	ZLSP950E36-3LN*	2CCF212303A0001	15/20*	-	ZLSP1250E36	2CCF212100M0036

* For version with N (4-pole)

Information about planning

Additional starter kit with AB-bus bar on demand.