

—
INSTALLATION INSTRUCTIONS

CM-EFS.2, CM-ESS.1, CM-ESS.2, CM-ESS.M

Single-phase voltage monitoring relays

CM-EFS.2



(DE) Betriebs- und Montageanleitung

Einphasige Fensterspannungsüberwachungsrelais, CM Reihe

Hinweis: Diese Betriebs- und Montageanleitung enthält nicht sämtliche Detailinformationen zu allen Typen der Produktreihe und kann auch nicht jeden Einsatzfall der Produkte berücksichtigen. Alle Angaben dienen ausschließlich der Produktbeschreibung und sind nicht als vertraglich vereinbarte Beschaffenheit aufzufassen. Weiterführende Informationen und Daten erhalten Sie in den Katalogen und Datenblättern der Produkte, über die örtliche ABB-Niederlassung sowie auf der ABB Homepage unter www.abb.com. Technische Änderungen jederzeit vorbehalten. In Zweifelsfällen gilt der deutsche Text.



Warnung! Gefährliche Spannung! Installation nur durch elektrotechnische Fachkraft. Landes-spezifische Vorschriften (z.B. VDE, etc.) beachten. Vor der Installation diese Betriebs- und Montageanleitung sorgfältig lesen und beachten. An die nicht beschrifteten Klemmen darf kein Leiter angeschlossen werden.

(EN) Operating and installation instructions

Single-phase voltage window monitoring relays, CM range

Note: These operating and installation instructions cannot claim to contain all detailed information of all types of this product range and can even not consider every possible application of the products. All statements serve exclusively to describe the product and have not to be understood as contractually agreed characteristics. Further information and data is obtainable from the catalogues and data sheets of this product, from the local ABB sales organisations as well as on the ABB homepage www.abb.com. Subject to change without prior notice. The German text applies in cases of doubt.



Warning! Hazardous voltage! Installation by person with electrotechnical expertise only and in accordance with the specific national regulations (e.g., VDE, etc). Before installing this unit, read these operating and installation instructions carefully and completely. Do not connect any conductor to terminals not labelled.

(FR) Instructions de montage et de mise en service

Contrôleurs de tension monophasée à fenêtre, gamme CM

Note: Ces instructions de service et de montage ne contiennent pas toutes les informations relatives à tous les types de cette gamme de produits et ne peuvent pas non plus tenir compte de tous les cas d'application. Toutes les indications ne sont données qu'à titre de description du produit et ne constituent aucune obligation contractuelle. Pour de plus amples informations, veuillez-vous référer aux catalogues et aux fiches techniques des produits, à votre

agence ABB ou sur notre site www.abb.com. Sous réserve de modifications techniques. En cas de divergences, le texte allemand fait foi.



Avertissement! Tension électrique dangereuse! Installation uniquement par des personnes qualifiées en électrotechnique et en conformité avec les prescriptions nationales (p.e. VDE, etc.). Avant l'installation de cet appareil veuillez lire l'intégralité de ces instructions. Ne pas connecter de conducteur aux bornes non marquées.

(ES) Instrucciones de montaje y de servicio

Relés de control de ventana de tensión monofásica, serie CM

Nota: Estas instrucciones no contienen todas las informaciones detalladas relativas a todos los tipos del producto ni pueden considerar todos los casos de operación. Todas las indicaciones son a título descriptivo del producto y no constituyen ninguna obligación contractual. Para más información, consulte los catálogos, las hojas de características, la sucursal local de ABB o la Web www.abb.com. Sujeto a cambios técnicos sin previo aviso. En caso de duda, prevalece el texto alemán.



¡Advertencia! ¡Tensión peligrosa! La instalación deberá ser realizada únicamente por electricistas especializados. Es necesario respetar las normas específicas del país (p.ej. VDE, etc.). Antes de la instalación lea completamente estas instrucciones. No conectar ningún conductor a los bornes no marcados.

(IT) Istruzioni per l'uso ed il montaggio

Relè di controllo di minima e massima tensione monofase (a finestra), serie CM

Nota: Le presenti istruzioni per l'uso ed il montaggio non contengono tutte le informazioni di dettaglio sull'intera gamma di prodotti e non possono trattare tutti i casi applicativi. Tutte le indicazioni servono esclusivamente a descrivere il prodotto e non costituiscono alcuna obbligazione contrattuale. Per ulteriori informazioni consultare i cataloghi ed i data sheet dei prodotti, o la nostra homepage www.abb.com, oppure rivolgersi alla filiale locale di ABB. Ci riserviamo il diritto di effettuare eventuali modifiche tecniche. In caso di discrepanze o fraintendimenti fa fede il testo in lingua tedesca.



Avvertenza! Tensione pericolosa! Far installare solo da un elettricista specializzato. Bisogna osservare le specifiche norme nazionali p.e. VDE, etc.). Prima dell'installazione leggere attentamente le seguenti istruzioni. Non collegare nessun conduttore ai morsetti non marcati.

(RU) Инструкция по установке и эксплуатации
**Однофазное реле контроля верхнего и
 нижнего пороговых значений напряжения,
 серия CM**

Примечание: Настоящая инструкция по установке и эксплуатации не претендует на полноту содержащейся здесь информации по всем типам изделий серии и не рассматривает все возможности применения настоящего изделия. Вся информация служит исключительно для его описания и не должна рассматриваться в качестве гарантированных характеристик, имеющих юридическую силу. Дополнительную информацию и данные можно получить из каталогов и листа тех. данных на настоящее изделие в местном представительстве компании ABB, а также на сайте компании ABB по адресу: www.abb.com. Возможны изменения без предварительного уведомления. При возникновении сомнений текст на немецком языке имеет приоритет.

Осторожно! Опасное напряжение! Монтаж должен выполняться только специалистом-электриком в соответствии с нормативным законодательством (т.к. VDE, итд). Перед установкой элемента внимательно ознакомьтесь с инструкцией. Не подключайте провода к клеммам, не имеющих обозначений.



(ZH) 操作与安装指南

单相电压双阈值监视继电器，CM系列

注意: 本操作指南不包含技术数据和全部应用说明，所有数据只是具有对产品特性进行说明的作用，因此不具备法律效应。详细说明请参阅技术样本或联络ABB当地办事处或浏览ABB网站 (www.abb.com)。如有更改恕不通知。并以德文为标准。

警告! 危险电压! 仅可由电气专业人员安装且需符合特定的国家规定 (如VDE等)。安装前, 请仔细且全部阅读该安装说明。无标识的端子不可接线。

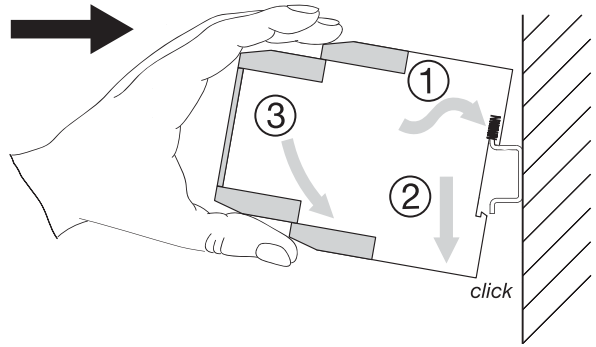

2CDC 253 012 F0014

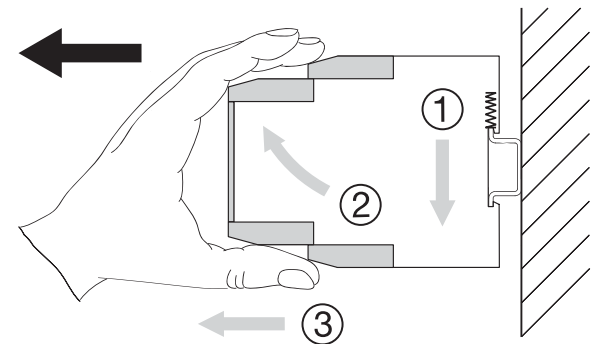

2CDC 253 013 F0014

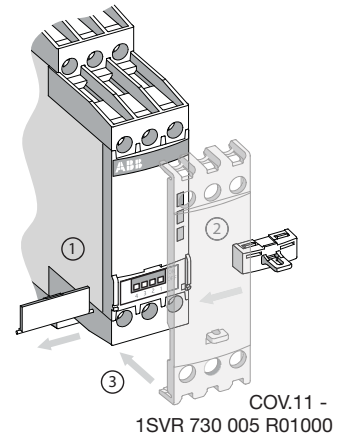
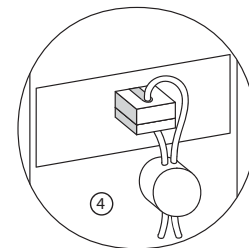

2CDC 253 025 F0014

Technical data:

T_a: -20 ... +60 °C (-4 ... +140 °F)

IP 20

Pollution degree 3

Additional information relating to cULus approval:

For use in Pollution Degree 2 Environment

Information complémentaire relative à la certification cULus:

Pour utilisation dans un environnement de degré de pollution 2

CM-EFS.xyS

CM-EFS.xyP

DIN ISO 2380-1 Form A
0.8 x 4 mm / 0.0315 x 0.157 in
DIN ISO 8764-1 PZ 1
Ø 4.5 mm / 0.177 in

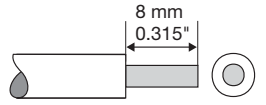
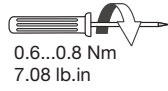

1 x 0.5...4.0 mm²
2 x 0.5...2.5 mm²
1 x 20...12 AWG
2 x 20...14 AWG

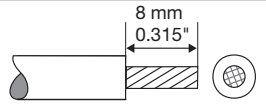

1 x 0.5...2.5 mm²
2 x 0.5...1.5 mm²
1 x 18...14 AWG
2 x 18...16 AWG

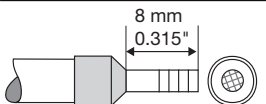

1 x 0.5...2.5 mm²
2 x 0.5...1.5 mm²
1 x 18...14 AWG
2 x 18...16 AWG

DIN 46228-1-A
DIN 46228-4-E

CONNECT (IN)

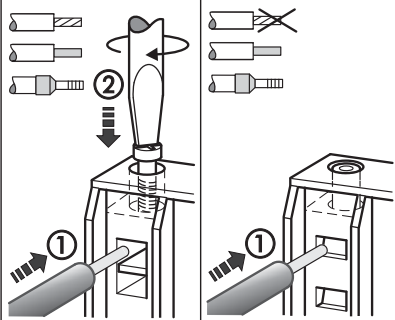

DISCONNECT (OUT)

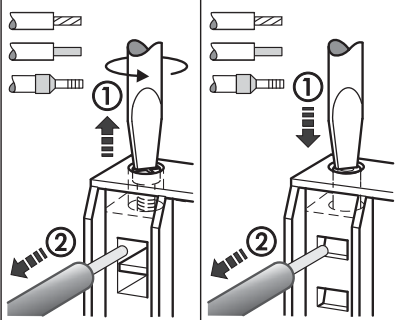

2CDC 252 014 F0015

2CDC 253 007 F0011

2CDC 253 030 F0011

I

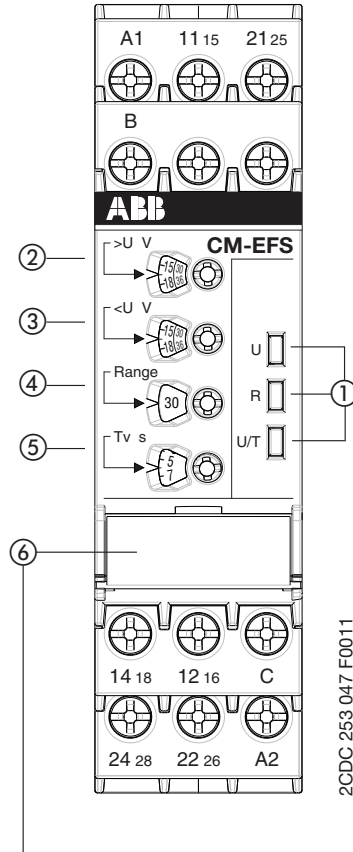

2CDC 253 047 F0011

II

Position	4	3	2	1
ON ↑	2x1 c/o		closed	
OFF	1x2 c/o		open	

2CDC 252 274 F0005

III

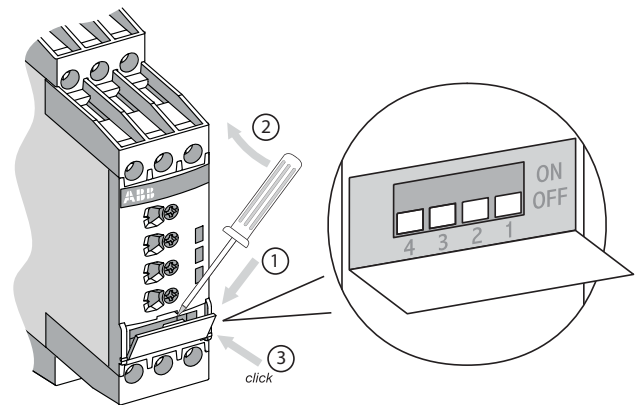





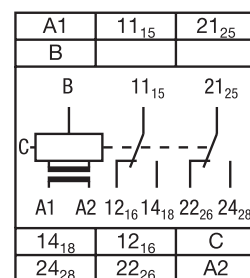



2CDC 253 030 F0011

IV



2CDC 252 207 F0005

I Frontansicht mit Bedienelementen

- ① Betriebszustandsanzeige mit LEDs
- U: LED rot - Anzeige der Messspannung
 Überspannung
 Unterspannung
- R: LED gelb - Anzeige der Schaltstellung der Ausgangsrelais
 angezogen
 angezogen, 
 abgefallen, 
- U/T: LED grün - Anzeige Steuerspeisespannung und Zeitablauf
 Steuerspeisespannung liegt an
 Auslöseverzögerung T_V aktiv
- ② Einstellung des Schwellwertes max.
 ③ Einstellung des Schwellwertes min.
 ④ Einstellung des Messbereiches
 (3-30 V; 6-60 V; 30-300 V; 60-600 V AC/DC)
 ⑤ Einstellung der Auslöseverzögerung T_V (0 s; 0,1-30 s)

Achtung:

Im Vergleich zur Vorgängerversion wurde die Position der Einstellpotentiometer ④ und ⑤ miteinander vertauscht!

II DIP-Schalterstellungen

- ⑥ DIP-Schalter zur Einstellung von:
- 1 ON = Rückfallverzögerung
 OFF = Ansprechverzögerung
- 2 ON = Ruhestromprinzip
 OFF = Arbeitsstromprinzip
- 3 ON = Speicherung ein
 OFF = Speicherung aus
- 4 ON = 2 x 1 Wechsler
 OFF = 1 x 2 Wechsler









Auslieferungszustand:
 Alle DIP-Schalter in Position OFF

III DIP-Schalterposition

IV Anschlussdiagramm

A1-A2	Steuerspeisespannung U_s
B-C	Messspannung
11(15)-12(16)/14(18)	Ausgangsrelais 1
21(25)-22(26)/24(28)	Ausgangsrelais 2

I Front view with operating controls

- ① Indication of operational states with LEDs
- U: LED red - Status indication of the measured voltage
 overvoltage
 undervoltage
- R: LED yellow - Status indication of the output relays
 energized
 energized, 
 de-energized, 
- U/T: LED green - Status indication of control supply voltage and timing
 Control supply voltage applied
 Tripping delay T_V active
- ② Adjustment of the threshold value max.
 ③ Adjustment of the threshold value min.
 ④ Adjustment of the measuring range
 (3-30 V; 6-60 V; 30-300 V; 60-600 V AC/DC)
 ⑤ Adjustment of the tripping delay T_V (0 s; 0,1-30 s)

Attention:

When compared with our previous version, the position of the adjustment potentiometers ④ and ⑤ have changed places!

II DIP switch functions

- ⑥ DIP switches for the adjustment of:
- 1 ON = OFF-delay
 OFF = ON-delay
- 2 ON = Closed-circuit principle
 OFF = Open-circuit principle
- 3 ON = Latching function ON
 OFF = Latching function OFF
- 4 ON = 2 x 1 c/o contact
 OFF = 1 x 2 c/o contacts

Default setting:
 All DIP switches in position OFF









III DIP switch position

IV Connection diagram

A1-A2	Control supply voltage U_s
B-C	Measured voltage
11(15)-12(16)/14(18)	Output relay 1
21(25)-22(26)/24(28)	Output relay 2

I Face avant et dispositifs de commande

① Indication de fonctionnement par LED

- U: LED rouge - Indication de la tension de mesure
 surtension
 sous-tension
- R: LED jaune - Indication de l'état des relais de sortie
 activés
 activés, 
 désactivés, 
- U/T: LED verte - Indication de la tension d'alimentation de commande et temporisation
 Tension d'alimentation de commande appliquée
 Temporisation de déclenchement T_v active

- ② Réglage de la valeur de seuil max.
 ③ Réglage de la valeur de seuil min.
 ④ Réglage de la gamme de mesure
 (3-30 V; 6-60 V; 30-300 V; 60-600 V AC/DC)
 ⑤ Réglage de la temporisation de déclenchement T_v
 (0 s; 0,1-30 s)

Attention:

En comparaison à la version précédente, la position des potentiomètres de réglage ④ et ⑤ a été intervertie!

II Fonctions des micro-interrupteurs

- ⑥ Micro-interrupteurs pour le réglage de:
- 1 ON = Temporisation au repos
OFF = Temporisation au travail
 - 2 ON = Fonctionnement en logique négative
OFF = Fonctionnement en logique positive
 - 3 ON = Mémorisation activée
OFF = Sans mémorisation
 - 4 ON = 2 x 1 inverseur
OFF = 1 x 2 inverseurs

Etat de livraison:

Tous les micro-interrupteurs en position OFF









III Position des micro-interrupteurs

IV Schéma de connexion

A1-A2	Tension d'alimentation de commande U_s
B-C	Tension de mesure
11(15)-12(16)/14(18)	Relais de sortie 1
21(25)-22(26)/24(28)	Relais de sortie 2

I Vista frontal con elementos de mando

① Indicadores de servicio con LEDs

- U: LED rojo - Indicación de la tensión de medida
 sobretensión
 subtensión
- R: LED amarillo - Indicación del estado de los relés de salida
 energizados
 energizados, 
 des-energizados, 
- U/T: LED verde - Indicación tensión de alimentación de mando y temporización
 Tensión de alimentación de mando aplicada
 Retardo de disparo T_v activado

- ② Ajuste del valor umbral máx.
 ③ Ajuste del valor umbral mín.
 ④ Ajuste del rango de medida
 (3-30 V; 6-60 V; 30-300 V; 60-600 V AC/DC)
 ⑤ Ajuste del retardo de disparo T_v (0 s; 0,1-30 s)

Atención:

En comparación con la versión anterior, la posición de los potenciómetros de ajuste ④ y ⑤ se ha intercambiado!

II Funciones de los interruptores DIP

- ⑥ Interruptores DIP para el ajuste de:
- 1 ON = Retardo a la desconexión
OFF = Retardo a la conexión
 - 2 ON = Principio de circuito cerrado
OFF = Principio de circuito abierto
 - 3 ON = Función de retención activada
OFF = Función de retención desactivada
 - 4 ON = 2 x 1 contacto conmutado
OFF = 1 x 2 contactos conmutados

Entrega de fábrica:



Todos los interruptores DIP en posición OFF

III Posición de los interruptores DIP

IV Esquema de conexión

A1-A2	Tensión de alimentación de mando U_s
B-C	Tensión de medida
11(15)-12(16)/14(18)	Relé de salida 1
21(25)-22(26)/24(28)	Relé de salida 2

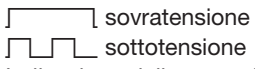
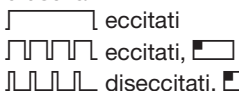
I Vista frontale con gli elementi di comando

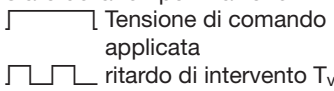
- ① LED di visualizzazione dello stato di funzionamento
- U: LED rosso - Indicazione della tensione di misura
 sovratensione
 sottotensione
- R: LED giallo - Indicazione dello stato dei relè d'uscita
 eccitati
 eccitati, 
 diseccitati, 
- U/T: LED verde - Indicazione tensione di comando e stato della temporizzazione
 Tensione di comando applicata
 ritardo di intervento T_v attivo
- ② Impostazione del valore di soglia max.
- ③ Impostazione del valore di soglia min.
- ④ Impostazione del campo di misura
 (3-30 V; 6-60 V; 30-300 V; 60-600 V AC/DC)
- ⑤ Impostazione del ritardo di intervento T_v (0 s; 0,1-30 s)

Attenzione:

Rispetto alla versione precedente, la posizione dei potenziometri di impostazione ④ e ⑤ è stata invertita!

II Funzioni degli interruttori DIP

- ⑥ Interruttori DIP per l'impostazione di:
- ON = Ritardo alla diseccitazione
OFF = Ritardo all'eccitazione
 - ON = Funzionamento normalmente chiuso
OFF = Funzionamento normalmente aperto
 - ON = Memorizzazione ON
OFF = Memorizzazione OFF
 - ON = 2 x 1 contatto di scambio
OFF = 1 x 2 contatti di scambio

Impostazione di fabbrica:



Tutti gli interruttori DIP in posizione OFF

III Posizione degli interruttori DIP

IV Schema di collegamento

A1-A2	Tensione di comando U_s
B-C	Tensione di misura
11(15)-12(16)/14(18)	Relè di uscita 1
21(25)-22(26)/24(28)	Relè di uscita 2

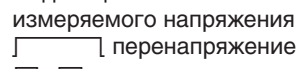
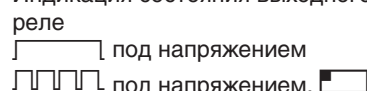
I Вид спереди на элементы управления

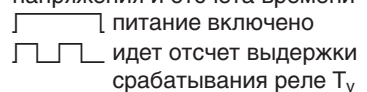
- ① Светодиоды для индикации состояния реле
- U: красный - Индикация состояния измеряемого напряжения
 перенапряжение
 пониженное напряжение
- R: желтый - Индикация состояния выходного реле
 под напряжением
 под напряжением, 
 обесточено, 
- U/T: зеленый - Индикация состояния питающего напряжения и отсчета времени
 питание включено
 идет отсчет выдержки срабатывания реле T_v
- ② Регулировка макс. значения порога срабатывания
- ③ Регулировка мин. значения порога срабатывания
- ④ Регулировка измеряемого диапазона
 (3-30 В; 6-60 В; 30-300 В; 60-600 В AC/DC)
- ⑤ Регулировка задержки срабатывания реле.
 T_v (0 с; 0,1-30 с)

Внимание:

По сравнению с предыдущей версией положение регулировочных потенциометров ④ и ⑤ было изменено!

II Функции DIP-переключателей

- ⑥ DIP-переключатели для настройки:
- ON = выдержка отпускания
OFF = выдержка срабатывания
 - ON = принцип замкн. цепи
OFF = принцип разомкн. цепи
 - ON = функция памяти ВКЛ.
OFF = функция памяти ВЫКЛ.
 - ON = 2 x 1 п.к. (вых. конт. перекл. несинхр.)
OFF = 1 x 2 п.к. (вых. конт. перекл. синхр.)

Состояние поставки: ВСЕ DIP-переключатели установлены в положении ВЫКЛ.

III Положения DIP-переключателей

IV Схема соединений

A1-A2	Питающее напряжение U_s
B-C	Измеряемое напряжение
11(15)-12(16)/14(18)	Выходное реле 1
21(25)-22(26)/24(28)	Выходное реле 2

I 前面板操作

① LED状态指示

U: 红色LED

- 测量电压的状态指示

 过电压

 欠电压

R: 黄色LED

- 输出继电器的动作状态指示

 动作

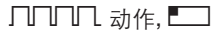
 动作,

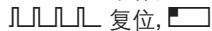
 复位,

U/T: 绿色LED

- 控制供电电压和定时的状态指示

 控制供电电压上电

 动作延时 T_V 有效

② 过电压阈值max. 调节

③ 欠电压阈值min. 调节

④ 测量范围调节

(3-30 V; 6-60 V; 30-300 V; 60-600 V AC/DC)

⑤ 动作延时时间 T_V 调节 (0 s; 0,1-30 s)

注意:

和我们的上一版产品相比, 新版产品的电位计④和⑤的位置改变了!

II DIP开关功能

⑥ DIP开关调节:

1 ON = 复位延时

OFF = 响应延时

2 ON = 闭路原则

OFF = 开路原则

3 ON = 故障保持功能有效

OFF = 故障保持功能无效

4 ON = 2 x 1 输出触点

OFF = 1 x 2 输出触点

默认设置:

所有DIP开关处于OFF位置。

III DIP开关位置

IV 接线图

A1-A2

控制供电电压 U_s

B-C

测量电压



11(15)-12(16)/14(18)





输出继电器 1

21(25)-22(26)/24(28)



输出继电器 2







Arbeitsweise

Das Fensterspannungsüberwachungsrelais CM-EFS.2 kann in einphasigen AC- oder DC-Netzen zur gleichzeitigen Über- „>U“ und Unterspannungsüberwachung „<U“ eingesetzt werden. Für die Über- und Unterspannungsüberwachung können (je nach Konfiguration) je ein Wechsler  oder beide Wechsler parallel  verwendet werden.



Die zu überwachende Spannung (Messwert) wird dazu an den Klemmen B-C eingespeist. Das Gerät arbeitet je nach Einstellung nach dem Arbeits-  oder Ruhestromprinzip  und kann auf Ansprech-  oder Rückfallverzögerung  konfiguriert werden.







Ansprechverzögerte  Fensterspannungsüberwachung mit parallel schaltenden Wechslern 

Über- bzw. unterschreitet der Messwert den eingestellten Schwellwert wird die Auslöseverzögerung T_v gestartet, wenn  konfiguriert ist. Befindet sich der Messwert nach Ablauf von T_v noch über bzw. unter dem Schwellwert minus bzw. plus der fixen Hysterese (5%), ziehen die Ausgangsrelais an  / fallen die Ausgangsrelais ab .

Unter- bzw. überschreitet der Messwert den Schwellwert minus bzw. plus die Hysterese, fallen die Ausgangsrelais ab  / ziehen die Ausgangsrelais an , sofern die Speicherung nicht aktiviert ist . Bei eingeschalteter Speicherung  bleiben die Ausgangsrelais angezogen  und fallen erst ab, wenn die Steuerspeisespannung unterbrochen wird / bleiben die Ausgangsrelais abgefallen  und ziehen erst wieder an, wenn die Steuerspeisespannung aus- und wieder eingeschaltet wird = Reset.

Rückfallverzögerte  Fensterspannungsüberwachung mit parallel schaltenden Wechslern 

Über- bzw. unterschreitet der Messwert den eingestellten Schwellwert ziehen die Ausgangsrelais an  / fallen die Ausgangsrelais ab , wenn  konfiguriert ist und bleiben für die eingestellte Auslöseverzögerung T_v in der jeweiligen Stellung.

























Unter- bzw. überschreitet der Messwert den Schwellwert minus bzw. plus die fixe Hysterese (5%), wird die Auslöseverzögerungszeit T_v gestartet, sofern die Speicherung nicht aktiviert ist . Nach Ablauf von T_v fallen die Ausgangsrelais ab  / ziehen die Ausgangsrelais wieder an  sofern die Speicherung nicht aktiviert ist . Bei eingeschalteter Speicherung  bleiben die Ausgangsrelais angezogen  und fallen erst ab, wenn die Steuerspeisespannung unterbrochen wird / bleiben die Ausgangsrelais abgefallen  und ziehen erst wieder an, wenn die Steuerspeisespannung aus- und wieder eingeschaltet wird = Reset.



Ist das Gerät auf  konfiguriert ist die Funktionsweise äquivalent zu der oben beschriebenen. Es ist lediglich zu beachten, dass statt beider Ausgangsrelais in diesem Fall nur je ein Ausgangsrelais schaltet.

„>U“ = 11₁₅-12₁₆/14₁₈ ; „<U“ = 21₂₅-22₂₆/24₂₈

Funktionsdiagramme

(Abbildungen siehe Rückseite)

- V Fensterspannungsüberwachung, 1 x 2 c/o  ansprechverzögert  ohne Speicherung 
- VI Fensterspannungsüberwachung, 1 x 2 c/o  rückfallverzögert  ohne Speicherung 
- VII Fensterspannungsüberwachung, 1 x 2 c/o  ansprechverzögert  mit Speicherung 
- VIII Fensterspannungsüberwachung, 1 x 2 c/o  rückfallverzögert  mit Speicherung 
- IX Fensterspannungsüberwachung, 2 x 1 c/o  ansprechverzögert  ohne Speicherung 
- X Fensterspannungsüberwachung, 2 x 1 c/o  rückfallverzögert  ohne Speicherung 
- XI Fensterspannungsüberwachung, 2 x 1 c/o  ansprechverzögert  mit Speicherung 
- XII Fensterspannungsüberwachung, 2 x 1 c/o  rückfallverzögert  mit Speicherung 

- ① Steuerspeisespannung
- ② Schwellwert max.
- ③ Hysterese
- ④ Messwert
- ⑤ Hysterese
- ⑥ Schwellwert min.
- ⑦ Arbeitsstromprinzip 
- ⑧ Ausgangsrelais 1
- ⑨ Ausgangsrelais 2
- ⑩ LED grün
- ⑪ LED rot
- ⑫ LED gelb
- ⑬ Ruhestromprinzip 

Ist der „Schwellwert max“ minus Hysterese < „Schwellwert min“ plus Hysterese eingestellt, so blinken alle LEDs synchron. Die Funktion der Ausgangsrelais bleibt unverändert.

Function diagrams

V Voltage window monitoring, 1 x 2 c/o ^{1x2 c/o} ON-delayed without latching

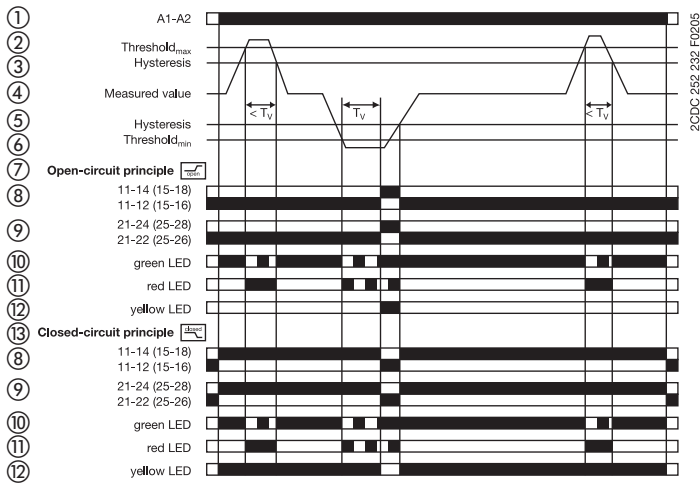

2CDC 252 232 F0205

VIII Voltage window monitoring, 1 x 2 c/o ^{1x2 c/o} OFF-delayed with latching

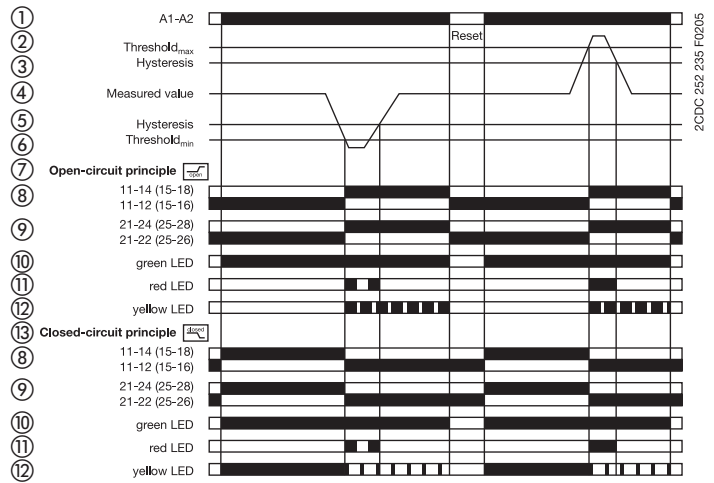

2CDC 252 235 F0205

VI Voltage window monitoring, 1 x 2 c/o ^{1x2 c/o} OFF-delayed without latching

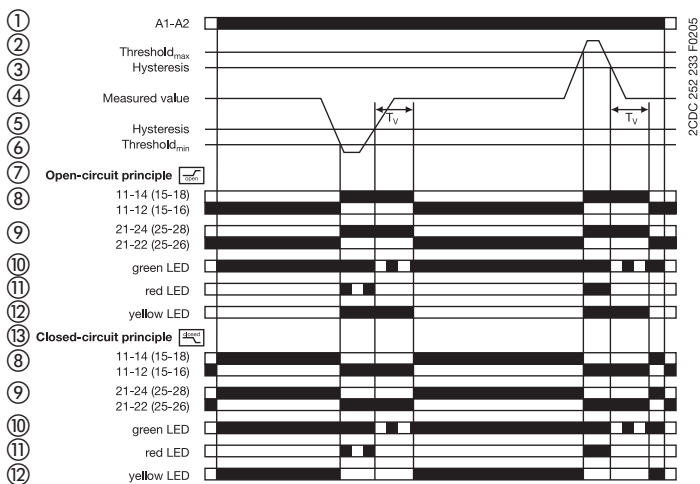

2CDC 252 233 F0205

IX Voltage window monitoring, 2 x 1 c/o ^{2x1 c/o} ON-delayed without latching

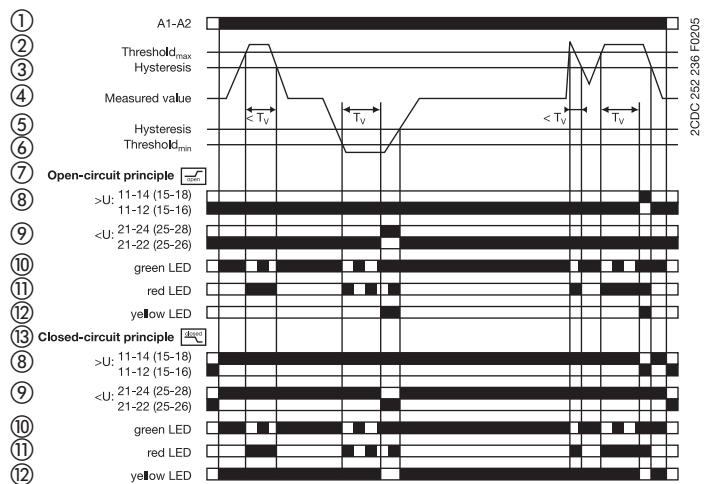

2CDC 252 236 F0205

VII Voltage window monitoring, 1 x 2 c/o ^{1x2 c/o} ON-delayed with latching

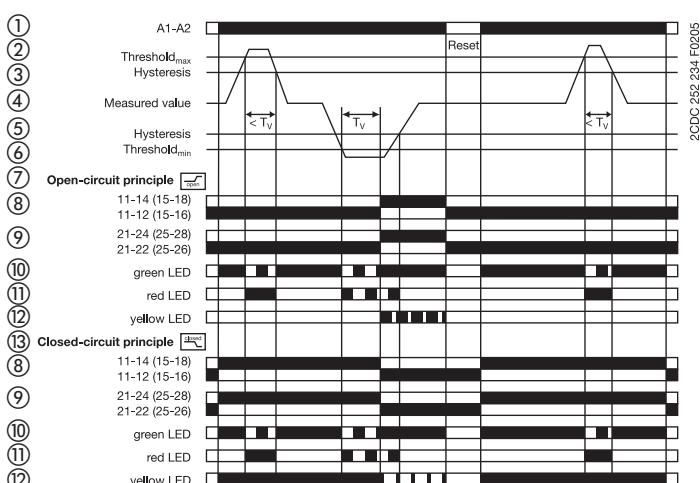

2CDC 252 234 F0205

X Voltage window monitoring, 2 x 1 c/o ^{2x1 c/o} OFF-delayed without latching

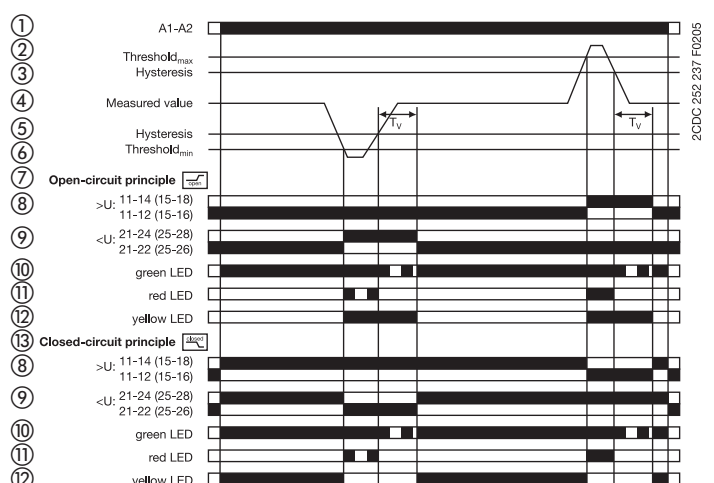

2CDC 252 237 F0205



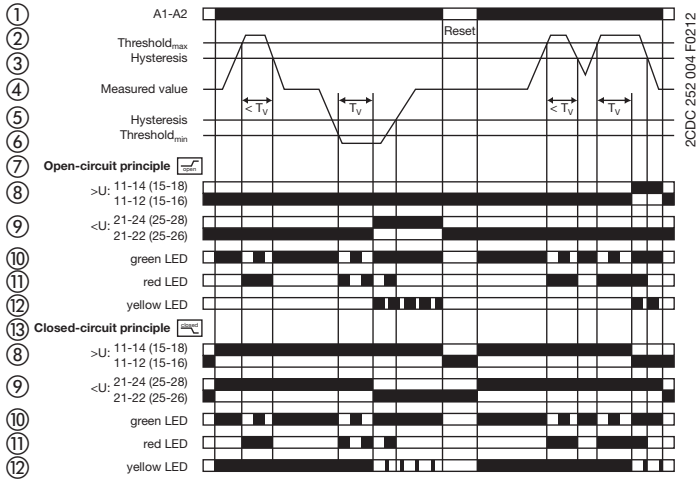

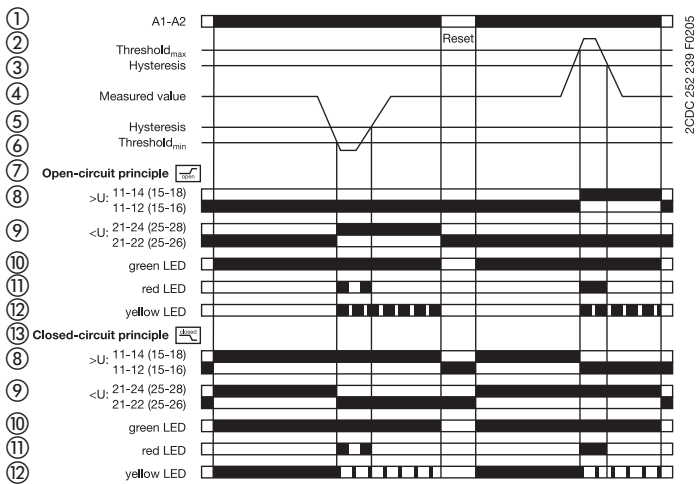

XI Voltage window monitoring, 2 x 1 c/o 2x1 c/o
ON-delayed with latching











XII Voltage window monitoring, 2 x 1 c/o 2x1 c/o
OFF-delayed with latching





Operating principle







The voltage window monitoring relay CM-EFS.2 can be used for the simultaneous monitoring of over- “>U” and undervoltages “<U” in single-phase AC or DC systems. Depending on the configuration, one c/o contact each  or both c/o contacts in parallel  can be used for the over- and undervoltage monitoring. The voltage to be monitored (measured value) is applied to terminals B-C. Open  or closed-circuit principle  as well as an adjustable ON  or OFF  tripping delay are selectable.

ON-delayed voltage window monitoring with parallel switching c/o contacts

If the measured value exceeds or drops below the adjusted threshold value, the tripping delay T_V starts, when  is configured. If T_V is complete and the measured value is still exceeding or below the threshold value minus / plus the fixed hysteresis (5%), the output relays energize  / de-energize . If the measured value exceeds or drops below the threshold value plus / minus the hysteresis and the latching function is not activated , the output relays de-energize  / energize . With activated latching function  the output relays remain energized  and de-energize only, when control supply voltage is interrupted / the output relays remain de-energized  and energize only, when control supply voltage is switched off and then again switched on = Reset.

OFF-delayed voltage window monitoring with parallel switching c/o contacts

























If the measured value exceeds or drops below the adjusted threshold value, the output relays energize  / de-energize , when  is configured, and remain in this position during the set tripping delay T_V .



If the measured value exceeds or drops below the threshold value plus / minus the fixed hysteresis (5%) and the latching function is not activated , the tripping delay T_V starts. After completion of T_V , the output relays de-energize  / energize , provided that the latching function is not activated . With activated latching function  the output relays remain energized  and de-energize only, when control supply voltage is interrupted / the output relays remain de-energized  and energize only, when control supply voltage is switched off and then again switched on = Reset.

When  is adjusted on the device, the functionality is equivalent to the one described above. There is only to consider that in this case, instead of both output relays, only one output relay each will be switched.

“>U” = 11₁₅-12₁₆/14₁₈ ; “<U” = 21₂₅-22₂₆/24₂₈







Function diagrams

- V Voltage window monitoring, 1 x 2 c/o 
ON-delayed  without latching 
- VI Voltage window monitoring, 1 x 2 c/o 
OFF-delayed  without latching 
- VII Voltage window monitoring, 1 x 2 c/o 
ON-delayed  with latching 
- VIII Voltage window monitoring, 1 x 2 c/o 
OFF-delayed  with latching 
- IX Voltage window monitoring, 2 x 1 c/o 
ON-delayed  without latching 
- X Voltage window monitoring, 2 x 1 c/o 
OFF-delayed  without latching 
- XI Voltage window monitoring, 2 x 1 c/o 
ON-delayed  with latching 
- XII Voltage window monitoring, 2 x 1 c/o 
OFF-delayed  with latching 



- ① Control supply voltage
- ② Threshold value max.
- ③ Hysteresis
- ④ Measured value
- ⑤ Hysteresis
- ⑥ Threshold value min.
- ⑦ Open-circuit principle 
- ⑧ Output relay 1
- ⑨ Output relay 2
- ⑩ green LED
- ⑪ red LED
- ⑫ yellow LED
- ⑬ Closed-circuit principle 







If the adjusted „threshold value max.“ minus the hysteresis is < „threshold value min.“ plus the hysteresis, all LEDs flash synchronously. The function of the output relays remains unchanged.

Principe de fonctionnement



Le contrôleur de tension à fenêtre CM-EFS.2 peut être utilisé pour surveiller simultanément une surtension «>U» et une sous-tension «<U» dans des réseaux AC ou DC monophasés. Selon la configuration, on peut utiliser un contact inverseur à la fois  ou les deux contacts inverseurs en parallèle . La tension de mesure (valeur mesurée) est appliquée aux bornes B-C. Les relais fonctionnent en logique positive  ou négative  et avec temporisation au travail  ou temporisation au repos , selon le réglage.







Contrôle de tension à fenêtre temporisé au travail , avec contacts inverseurs en parallèle

Si la valeur mesurée dépasse ou chute en dessous de la valeur de seuil ajustée, la temporisation de déclenchement T_v commence, pourvu que  soit configurée. Les relais de sortie s'activent  / se désactivent , si, après la fin de T_v , la valeur mesurée se trouve encore en dessus ou en dessous de la valeur de seuil moins ou plus l'hystérésis (fixé à 5 %).

Si la valeur mesurée dépasse ou chute en dessous de la valeur de seuil plus ou moins l'hystérésis fixe, les relais de sortie se désactivent  / s'activent , pourvu que la mémorisation ne soit pas activée . Avec la mémorisation activée , les relais de sortie restent activés  et se désactivent seulement quand la tension d'alimentation de commande est coupée / les relais de sortie restent au repos  et s'activent seulement quand la tension d'alimentation de commande est coupée et puis branchée de nouveau = Remise à zéro.

Contrôle de tension à fenêtre temporisé au repos , avec contacts inverseurs en parallèle

























Si la valeur mesurée dépasse ou chute en dessous de la valeur de seuil ajustée, les relais de sortie s'activent  / se désactivent , pourvu que  soit configurée, et gardent la position pendant la temporisation de déclenchement T_v .



La temporisation de déclenchement T_v commence, si la valeur mesurée dépasse ou chute en dessous de la valeur de seuil plus ou moins l'hystérésis (fixé à 5 %), pourvu que la mémorisation ne soit pas activée . Après la fin de T_v , les relais de sortie se désactivent  / s'activent , pourvu que la mémorisation ne soit pas activée . Avec la mémorisation activée , les relais de sortie restent activés  et se désactivent seulement quand la tension d'alimentation de commande est coupée / les relais de sortie restent au repos  et s'activent seulement quand la tension d'alimentation de commande est coupée et puis branchée de nouveau = Remise à zéro.

Si le relais est configuré sur  le fonctionnement est équivalent à cette description. On doit seulement considérer en ce cas, qu'au lieu des deux relais de sortie, un seul relais commute.

">U" = 11₁₅-12₁₆/14₁₈ ; "<U" = 21₂₅-22₂₆/24₂₈







Diagrammes de fonctionnement

- V Contrôle de tension à fenêtre, 1 x 2 c/o  temporisé au travail  sans mémorisation 
- VI Contrôle de tension à fenêtre, 1 x 2 c/o  temporisé au repos  sans mémorisation 
- VII Contrôle de tension à fenêtre, 1 x 2 c/o  temporisé au travail  avec mémorisation 
- VIII Contrôle de tension à fenêtre, 1 x 2 c/o  temporisé au repos  avec mémorisation 
- IX Contrôle de tension à fenêtre, 2 x 1 c/o  temporisé au travail  sans mémorisation 
- X Contrôle de tension à fenêtre, 2 x 1 c/o  temporisé au repos  sans mémorisation 
- XI Contrôle de tension à fenêtre, 2 x 1 c/o  temporisé au travail  avec mémorisation 
- XII Contrôle de tension à fenêtre, 2 x 1 c/o  temporisé au repos  avec mémorisation 



- ① Tension d'alimentation de commande
- ② Valeur de seuil max.
- ③ Hystérésis
- ④ Valeur mesurée
- ⑤ Hystérésis
- ⑥ Valeur de seuil min.
- ⑦ Fonctionnement en logique positive 
- ⑧ Relais de sortie 1
- ⑨ Relais de sortie 2
- ⑩ LED verte
- ⑪ LED rouge
- ⑫ LED jaune
- ⑬ Fonctionnement en logique négative 







Si la „valeur de seuil max.“ moins l'hystérésis est ajustée < la „valeur de seuil min.“ plus l'hystérésis, toutes les LED clignotent de manière synchrone. Le fonctionnement des relais de sortie reste inchangé.

Funcionamiento



El relé de control de ventana de tensión CM-EFS.2 puede utilizarse para la monitorización simultánea de sobre “>U” y subtensiones “<U” en redes monofásicas de CA o CC. Dependiendo de la configuración, un contacto conmutado para cada  o los dos contactos conmutados en paralelo  pueden utilizarse para la monitorización de sobre y subtensión. La tensión de medida (valor medido) se aplica a los terminales B-C. Principio de circuito abierto  o cerrado  además de un retardo ajustable de disparo ON  y OFF  seleccionable.







Control de ventana de tensión con retardo a la conexión y conexión paralelo de contactos conmutados

El retardo de disparo T_V empieza si el valor medido, respectivamente, excede o cae por debajo del valor umbral cuando  se ha configurado. Si T_V se ha completado y el valor medido sigue por encima o por debajo del valor umbral ajustado, menos / más el valor fijo de histéresis (5%), los relés de salida se energizan  / des-energizan .

Si el valor medido, respectivamente, excede o cae por debajo del valor umbral ajustado, más/menos la histéresis y la función de retención no está activada , los relés de salida se des-energizan  / energizan . Con la función de retención activada , los relés de salida se mantienen energizados  y se des-energizan sólo cuando se interrumpe la alimentación / los relés de salida se mantienen des-energizados  y se energizan sólo cuando se desconecta la tensión de alimentación de mando y se vuelve a conectar = Reset.

Control de ventana de tensión con retardo a la desconexión y conexión paralelo de contactos conmutados

























Si el valor medido, respectivamente, excede o cae por debajo del valor umbral ajustado, los relés de salida se energizan  / des-energizan  cuando  se ha configurado, manteniéndose en esta posición durante el retardo de disparo T_V ajustado.



El retardo de disparo T_V empieza si el valor medido, respectivamente, excede o cae por debajo del valor umbral más/ menos el valor fijo de histéresis (5%) y la función de retención no está activada . Al completar el tiempo T_V , los relés de salida se des-energizan  / energizan  siempre que la función de retención no esté activada . Con la función de retención activada , los relés de salida se mantienen energizados  y se des-energizan sólo cuando se interrumpe la alimentación / los relés de salida se mantienen des-energizados  y se energizan sólo cuando se desconecta la tensión de alimentación de mando y se vuelve a conectar = Reset.

Cuando  se ajusta en el dispositivo, la funcionalidad es equivalente a lo descrito anteriormente. Sólo debe considerarse que en este caso, en vez de los dos relés de salida, sólo uno conmutará.

“>U” = 11₁₅-12₁₆/14₁₈; “<U” = 21₂₅-22₂₆/24₂₈







Diagramas de funcionamiento

- V Control de ventana de tensión, 1 x 2 c/o  retardo a la conexión  sin función de retención 
- VI Control de ventana de tensión, 1 x 2 c/o  retardo a la desconexión  sin función de retención 
- VII Control de ventana de tensión, 1 x 2 c/o  retardo a la conexión  con función de retención 
- VIII Control de ventana de tensión, 1 x 2 c/o  retardo a la desconexión  con función de retención 
- IX Control de ventana de tensión, 2 x 1 c/o  retardo a la conexión  sin función de retención 
- X Control de ventana de tensión, 2 x 1 c/o  retardo a la desconexión  sin función de retención 
- XI Control de ventana de tensión, 2 x 1 c/o  retardo a la conexión  con función de retención 
- XII Control de ventana de tensión, 2 x 1 c/o  retardo a la desconexión  con función de retención 



- ① Tensión de alimentación de mando
- ② Valor umbral máx.
- ③ Hystéresis
- ④ Valor medido
- ⑤ Hystéresis
- ⑥ Valor umbral mín.
- ⑦ Principio de circuito abierto 
- ⑧ Relé de salida 1
- ⑨ Relé de salida 2
- ⑩ LED verde
- ⑪ LED rojo
- ⑫ LED amarillo
- ⑬ Principio de circuito cerrado 







Si el „valor umbral máx.“ menos la histéresis es < al „valor umbral mín.“ más la histéresis, todos los LEDs parpadearán de forma sincrónica. La función de los relés de salida permanecerá invariable.

Funzionamento



Il relè di controllo di tensione minima e massima (a finestra) CM-EFS.2 può essere utilizzato per controllare contemporaneamente sovra- „>U“ e sottotensione „<U“ in sistemi CA/CC monofasi. A seconda della configurazione, si possono utilizzare un contatto di scambio alla volta  o entrambi contatti di scambio in parallelo  per il controllo di sovra- e sottotensione. La tensione di misura (valore misurato) viene applicata ai morsetti B-C. A seconda della impostazione, l'apparecchio lavora secondo il principio di funzionamento normalmente aperto  o normalmente chiuso  e può essere impostato anche un ritardo all'eccitazione  o un ritardo alla diseccitazione .







Controllo di tensione a finestra ritardato all'eccitazione con contatti di scambio collegati in parallelo

Se il valore misurato aumenta o diminuisce oltre il valore di soglia impostato, il ritardo di intervento T_v inizia. Se, dopo il decorso di T_v , il valore misurato è ancora superiore o inferiore al valore di soglia meno o più l'isteresi fissa (5 %), i relè di uscita si eccitano  / si diseccitano .

Se il valore misurato diminuisce o aumenta oltre il valore di soglia meno o più l'isteresi, i relè di uscita si diseccitano  / si eccitano , a meno che la memorizzazione non sia attivata . Con la memorizzazione attivata , i relè di uscita rimangono eccitati  e si diseccitano solo se la tensione di comando viene interrotta / i relè di uscita rimangono diseccitati  e si eccitano solo se la tensione di comando viene disinserita e poi di nuovo inserita = Ripristino

Controllo di tensione a finestra ritardato alla diseccitazione con contatti di scambio collegati in parallelo

























Se  è configurato e il valore misurato aumenta o diminuisce oltre il valore di soglia impostato, i relè di uscita si eccitano  / i relè di uscita si diseccitano  e rimangono nella loro posizione durante il decorso del ritardo di intervento T_v .



Se il valore misurato diminuisce o aumenta oltre il valore di soglia meno o più l'isteresi fissa (5 %), il ritardo di intervento T_v inizia, in quanto che la memorizzazione non sia attivata . Dopo il decorso di T_v , i relè di uscita si diseccitano  / si eccitano , a meno che la memorizzazione non sia attivata . Con la memorizzazione attivata , i relè di uscita rimangono eccitati  e si diseccitano solo se la tensione di comando viene interrotta / i relè di uscita rimangono diseccitati  e si eccitano solo se la tensione di comando viene disinserita e poi di nuovo inserita = Ripristino

Se  è settato sul apparecchio, la funzionalità è equivalente a quella descritta qui sopra. In questo caso bisogna considerare che commuterà solo un relè di uscita invece che due.

„>U“ = 11₁₅-12₁₆/14₁₈ ; „<U“ = 21₂₅-22₂₆/24₂₈

Diagrammi di funzionamento

- V Controllo di tensione a finestra, 1 x 2 c/o  ritardo all'eccitazione  senza memorizzazione 
- VI Controllo di tensione a finestra, 1 x 2 c/o  ritardo alla diseccitazione  senza memorizzazione 
- VII Controllo di tensione a finestra, 1 x 2 c/o  ritardo all'eccitazione  con memorizzazione 
- VIII Controllo di tensione a finestra, 1 x 2 c/o  ritardo alla diseccitazione  con memorizzazione 
- IX Controllo di tensione a finestra, 2 x 1 c/o  ritardo all'eccitazione  senza memorizzazione 
- X Controllo di tensione a finestra, 2 x 1 c/o  ritardo alla diseccitazione  senza memorizzazione 
- XI Controllo di tensione a finestra, 2 x 1 c/o  ritardo all'eccitazione  con memorizzazione 
- XII Controllo di tensione a finestra, 2 x 1 c/o  ritardo alla diseccitazione  con memorizzazione 

- ① Tensione di comando
- ② Valore di soglia max.
- ③ Isteresi
- ④ Valore misurato
- ⑤ Isteresi
- ⑥ Valore di soglia min.
- ⑦ Funzionamento normalmente aperto 
- ⑧ Relè di uscita 1
- ⑨ Relè di uscita 2
- ⑩ LED verde
- ⑪ LED rosso
- ⑫ LED giallo
- ⑬ Funzionamento normalmente chiuso 

Se il „valore di soglia max.“ meno l'isteresi è impostato < il „valore di soglia min.“ più l'isteresi, tutti i LED lampeggiano sincronicamente. La funzione dei relè di uscita rimane inalterata.

Принцип работы

Реле контроля верхнего и нижнего пороговых значений напряжения CM-EFS.2 может использоваться для одновременного контроля перенапряжения “> U” или пониженного напряжения “< U” в однофазных сетях постоянного или переменного тока. В зависимости от конфигурации каждый выходной п.к. в отдельности или оба перекидных контакта параллельно могут использоваться для контроля перенапряжения или пониженного напряжения. Контролируемое напряжение (измеряемое значение) подается на клеммы В-С. Можно выбрать принцип разомкнутой цепи, замкнутой цепи, а также регулируемую задержку срабатывания или отпускания реле.

Контроль верхнего и нижнего пороговых значений напряжения с задержкой срабатывания с выходными п.к. работающими параллельно

Если измеряемое значение превышает или соответственно падает ниже заданного порогового значения, начнется отсчет времени задержки срабатывания T_v , если задана конфигурация . Если отсчет времени T_v закончился, а измеряемое значение все еще превышает/остается ниже порогового значения за минусом/плюсом заданного гистерезиса (5%), то выходные реле возбуждаются /обесточиваются .

Если измеряемое значение возвращается в заданные пределы, т.е. превышает минимальный порог/опускается ниже максимального порога на величину гистерезиса и функция памяти не включена , то выходные реле обесточиваются /возбуждаются . При включенной функции памяти выходные реле остаются под напряжением и обесточиваются только когда прерывается электропитание/выходные реле остаются обесточенными и возбуждаются только когда питающее напряжение отключается, а затем снова включается = Сброс.

Реле контроля верхнего и нижнего пороговых значений напряжения с задержкой отпускания с выходными п.к., работающими параллельно

Если измеряемое значение превышает или соответственно упадет ниже заданного порогового значения, то выходные реле возбуждаются /обесточиваются , если задана конфигурация и остаются в этом положении в течение заданного периода задержки срабатывания T_v .

Если измеряемое значение возвращается в заданные пределы, т.е. превышает минимальный порог/опускается ниже максимального порога на заданную величину гистерезиса (5%) и функция памяти не включена , то начнется отсчет времени отпускания реле T_v . После окончания отсчета времени T_v выходные реле обесточиваются /возбуждаются при условии, что функция памяти не включена . При включенной функции памяти выходные реле остаются под напряжением и обесточиваются только когда прерывается электропитание/выходные реле остаются обесточенными и возбуждаются только когда питающее напряжение отключается, а затем снова включается = Сброс.

При настройке на приборе функции все функции идентичны описанным выше. Следует учитывать только тот факт, что в этом случае каждое выходное реле срабатывает отдельно, т.е. одно выходное реле срабатывает при перенапряжении, другое % при снижении напряжения.

$$“>U” = 11_{15}-12_{16}/14_{18}; “<U” = 21_{25}-22_{26}/24_{28}$$

Функциональные схемы

- V Контроль верхнего и нижнего пороговых значений напряжения, с выходными п.к. 1x2, работающими параллельно с задержкой срабатывания без запоминания
- VI Контроль верхнего и нижнего пороговых значений напряжения, с выходными п.к. 1x2, работающими параллельно с задержкой отпускания без запоминания
- VII Контроль верхнего и нижнего пороговых значений напряжения, с выходными п.к. 1x2, работающими параллельно с задержкой срабатывания с запоминанием
- VIII Контроль верхнего и нижнего пороговых значений напряжения, с выходными п.к. 1x2, работающими параллельно с задержкой отпускания с запоминанием
- IX Контроль верхнего и нижнего пороговых значений напряжения, с выходными п.к. 2 x 1, работающими несинхронно с задержкой срабатывания без запоминания
- X Контроль верхнего и нижнего пороговых значений напряжения, с выходными п.к. 2 x 1, работающими несинхронно с задержкой отпускания без запоминания
- XI Контроль верхнего и нижнего пороговых значений напряжения, с выходными п.к. 2 x 1, работающими несинхронно с задержкой срабатывания с запоминанием
- XII Контроль верхнего и нижнего пороговых значений напряжения, с выходными п.к. 2 x 1, работающими несинхронно с задержкой отпускания с запоминанием

- ① Питающее напряжение
- ② Макс. пороговое значение
- ③ Гистерезис
- ④ Измеряемое значение
- ⑤ Гистерезис
- ⑥ Мин. пороговое значение
- ⑦ Принцип разомкнутой цепи
- ⑧ Выходное реле 1
- ⑨ Выходное реле 2
- ⑩ Зеленый светодиод
- ⑪ Красный светодиод
- ⑫ Желтый светодиод
- ⑬ Принцип замкнутой цепи

Если заданное „макс. пороговое значение“ минус гистерезис < „мин. порогового значения“ плюс гистерезис, то все светодиоды мигают синхронно. Функция выходных реле остается без изменений.

工作原理

电压双阈值监视继电器CM-EFS.2可以同时监视单相交流或直流系统的过电压“>U”和欠电压“<U”。根据设置，每个输出c/o触点^[2x1 c/o]或2个输出c/o触点^[1x2 c/o]可用于过电压和欠电压监视。被监视电压（测量值）连接于端子B-C。开路^[]或闭路原则^[]以及响应延时^[]或复位延时^[]都可选择。

响应延时 ^[] 电压双阈值监视，带2个c/o开关触点 ^[1x2 c/o]

若测量值超过或低于设定的阈值，响应延时 T_v 开始计时（如设置了响应延时^[]）。当计时结束，测量值仍然大于或小于阈值减去/加上固定磁滞（5%），输出继电器动作^[]/复位^[]。

若测量值大于或小于阈值加上/减去磁滞，且故障存储功能未被激活时^[]，输出继电器复位^[]/动作^[]。若故障存储功能被激活时^[]，输出继电器保持动作^[]，仅当控制供电电压中断时才复位；输出继电器保持复位^[]，仅当控制供电电压中断后重新上电=reset时才动作。

复位延时 ^[] 电压双阈值监视，带2个c/o开关触点 ^[1x2 c/o]

若测量值超过或低于设定的阈值，输出继电器动作^[]/复位^[]。若设置了复位延时^[]，则在相应的延时时间 T_v 内保持该位置。若测量值大于或小于阈值加上/减去固定磁滞（5%），且故障存储功能未被激活时^[]，响应延时 T_v 开始计时。当计时结束，输出继电器复位^[]/动作^[]。若故障存储功能被激活时^[]，输出继电器保持动作^[]，仅当控制供电电压中断时才复位；输出继电器保持复位^[]，仅当控制供电电压中断后重新上电=reset时才动作。

当设置为^[2x1 c/o]时，相当于设置成以上描述中的其中一种功能，在这种情况下，2个输出继电器将分别动作，而不是同时动作。

“>U” = 11₁₅-12₁₆/14₁₈；“<U” = 21₂₅-22₂₆/24₂₈

功能图

- V 电压双阈值监视，1 x 2 c/o ^[1x2 c/o]
响应延时 ^[] 不带故障存储 ^[]
- VI 电压双阈值监视，1 x 2 c/o ^[1x2 c/o]
复位延时 ^[] 不带故障存储 ^[]
- VII 电压双阈值监视，1 x 2 c/o ^[1x2 c/o]
响应延时 ^[] 带故障存储 ^[]
- VIII 电压双阈值监视，1 x 2 c/o ^[1x2 c/o]
复位延时 ^[] 带故障存储 ^[]
- IX 电压双阈值监视，2 x 1 c/o ^[2x1 c/o]
响应延时 ^[] 不带故障存储 ^[]
- X 电压双阈值监视，2 x 1 c/o ^[2x1 c/o]
复位延时 ^[] 不带故障存储 ^[]
- XI 电压双阈值监视，2 x 1 c/o ^[2x1 c/o]
响应延时 ^[] 带故障存储 ^[]
- XII 电压双阈值监视，2 x 1 c/o ^[2x1 c/o]
复位延时 ^[] 带故障存储 ^[]

- ① 控制供电电压
- ② 过电压阈值max.
- ③ 磁滞
- ④ 测量值
- ⑤ 迟滞
- ⑥ 欠电压阈值min.
- ⑦ 开路原则 ^[]
- ⑧ 输出继电器1
- ⑨ 输出继电器2
- ⑩ 绿色 LED
- ⑪ 红色 LED
- ⑫ 黄色 LED
- ⑬ 闭路原则 ^[]

若设定的“过电压阈值”减去迟滞 < “欠电压阈值”加上迟滞，所有LED会同时闪烁，输出继电器的功能保持不变。

CM-ESS.1 / CM-ESS.2



(DE) Betriebs- und Montageanleitung Einphasige Spannungsüberwachungsrelais, CM Reihe

Hinweis: Diese Betriebs- und Montageanleitung enthält nicht sämtliche Detailinformationen zu allen Typen der Produktreihe und kann auch nicht jeden Einsatzfall der Produkte berücksichtigen. Alle Angaben dienen ausschließlich der Produktbeschreibung und sind nicht als vertraglich vereinbarte Beschaffenheit aufzufassen. Weiterführende Informationen und Daten erhalten Sie in den Katalogen und Datenblättern der Produkte, über die örtliche ABB-Niederlassung sowie auf der ABB Homepage unter www.abb.com. Technische Änderungen jederzeit vorbehalten. In Zweifelsfällen gilt der deutsche Text.



Warnung! Gefährliche Spannung! Installation nur durch elektrotechnische Fachkraft. Landes-spezifische Vorschriften (z.B. VDE, etc.) beachten. Vor der Installation diese Betriebs- und Montageanleitung sorgfältig lesen und beachten. An die nicht beschrifteten Klemmen darf kein Leiter angeschlossen werden.

(EN) Operating and installation instructions Single-phase voltage monitoring relays, CM range

Note: These operating and installation instructions cannot claim to contain all detailed information of all types of this product range and can even not consider every possible application of the products. All statements serve exclusively to describe the product and have not to be understood as contractually agreed characteristics. Further information and data is obtainable from the catalogues and data sheets of this product, from the local ABB sales organisations as well as on the ABB homepage www.abb.com. Subject to change without prior notice. The German text applies in cases of doubt.



Warning! Hazardous voltage! Installation by person with electrotechnical expertise only and in accordance with the specific national regulations (e.g., VDE, etc). Before installing this unit, read these operating and installation instructions carefully and completely. Do not connect any conductor to terminals not labelled.

(FR) Instructions de montage et de mise en service Contrôleurs de tension monophasée, gamme CM

Note: Ces instructions de service et de montage ne contiennent pas toutes les informations relatives à tous les types de cette gamme de produits et ne peuvent pas non plus tenir compte de tous les cas d'application. Toutes les indications ne sont données qu'à titre de description du produit et ne constituent aucune obligation contractuelle. Pour de plus amples informations, veuillez-vous référer aux catalogues et aux fiches techniques des produits, à votre agence ABB ou sur notre site www.abb.com. Sous réserve de modifications techniques. En cas de divergences, le texte allemand fait foi.



Avertissement! Tension électrique dangereuse! Installation uniquement par des personnes qualifiées en électrotechnique et en conformité avec les prescriptions nationales (p.e. VDE, etc.). Avant l'installation de cet appareil veuillez lire l'intégralité de ces instructions. Ne pas connecter de conducteur aux bornes non marquées.

(ES) Instrucciones de montaje y de servicio Relés de control de tensión monofásica, serie CM

Nota: Estas instrucciones no contienen todas las informaciones detalladas relativas a todos los tipos del producto ni pueden considerar todos los casos de operación. Todas las indicaciones son a título descriptivo del producto y no constituyen ninguna obligación contractual. Para más información, consulte los catálogos, las hojas de características, la sucursal local de ABB o la Web www.abb.com. Sujeto a cambios técnicos sin previo aviso. En caso de duda, prevalece el texto alemán.



¡Advertencia! ¡Tensión peligrosa! La instalación deberá ser realizada únicamente por electricistas especializados. Es necesario respetar las normas específicas del país (p.ej. VDE, etc.). Antes de la instalación lea completamente estas instrucciones. No conectar ningún conductor a los bornes no marcados.

(IT) Istruzioni per l'uso ed il montaggio Relè di controllo di tensione monofase, serie CM

Nota: Le presenti istruzioni per l'uso ed il montaggio non contengono tutte le informazioni di dettaglio sull'intera gamma di prodotti e non possono trattare tutti i casi applicativi. Tutte le indicazioni servono esclusivamente a descrivere il prodotto e non costituiscono alcuna obbligazione contrattuale. Per ulteriori informazioni consultare i cataloghi ed i data sheet dei prodotti, o la nostra homepage www.abb.com, oppure rivolgersi alla filiale locale di ABB. Ci riserviamo il diritto di effettuare eventuali modifiche tecniche. In caso di discrepanze o fraintendimenti fa fede il testo in lingua tedesca.



Avvertenza! Tensione pericolosa! Far installare solo da un elettricista specializzato. Bisogna osservare le specifiche norme nazionali p.e. VDE, etc.). Prima dell'installazione leggere attentamente le seguenti istruzioni. Non collegare nessun conduttore ai morsetti non marcati.

(RU) Инструкция по установке и эксплуатации Однофазное реле контроля напряжения, серия CM

Примечание: Настоящая инструкция по установке и эксплуатации не претендует на полноту содержащейся здесь информации по всем типам изделий серии и не рассматривает все возможности применения настоящего изделия. Вся информация служит исключительно для его описания и не должна рассматриваться в качестве гарантированных характеристик, имеющих юридическую силу. Дополнительную информацию и данные можно получить из каталогов и листа тех. данных на настоящее изделие в местном представительстве компании ABB, а также на сайте компании ABB по адресу: www.abb.com. Возможны изменения без предварительного уведомления. При возникновении сомнений текст на немецком языке имеет приоритет.



Осторожно! Опасное напряжение! Монтаж должен выполняться только специалистом-электриком в соответствии с нормативным законодательством (т.к. VDE, итд). Перед установкой элемента внимательно ознакомьтесь с инструкцией. Не подключайте провода к клеммам, не имеющий обозначений.

(ZH) 操作与安装指南

单相电压监视继电器, CM系列

注意: 本操作指南不包含技术数据和全部应用说明, 所有数据只是具有对产品特性进行说明的作用, 因此不具备法律效应。详细说明请参阅技术样本或联络ABB当地办事处或浏览ABB网站 (www.abb.com)。如有更改恕不通知。并以德文为标准。



警告! 危险电压! 仅可由电气专业人员安装且需符合特定的国家规定 (如VDE等)。安装前, 请仔细且全部阅读该安装说明。无标识的端子不可接线。

Technical data:

T_a: -20 ... +60 °C (-4 ... +140 °F)

IP 20

Pollution degree 3

Additional information relating to cULus approval:

For use in pollution degree 2 environment

Information complémentaire relative à la certification cULus:

Pour utilisation dans un environnement de degré de pollution 2

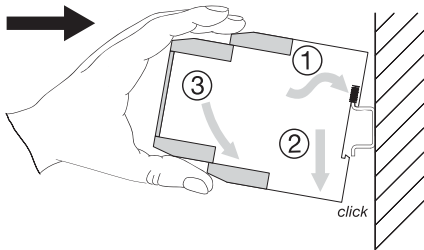

2CDC 253 012 F0014

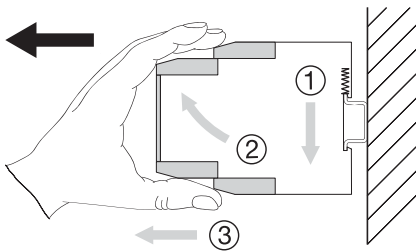

2CDC 253 013 F0014

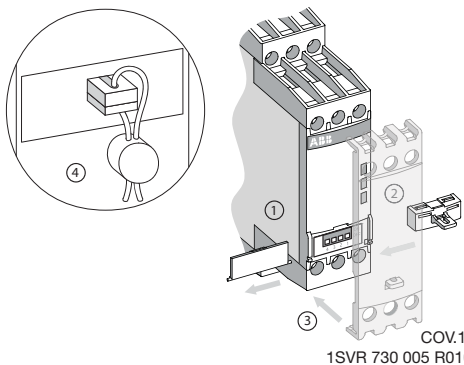

2CDC 253 025 F0014

COV.11 -
1SVR 730 005 R01000

CM-ESS.xyS

CM-ESS.xyP

DIN ISO 2380-1 Form A 0.8 x 4 mm / 0.0315 x 0.157 in DIN ISO 8764-1 PZ 1 Ø 4.5 mm / 0.177 in	 0.6...0.8 Nm 7.08 lb.in	
 8 mm 0.315"	1 x 0.5...4.0 mm ² 2 x 0.5...2.5 mm ² 1 x 20...12 AWG 2 x 20...14 AWG	2 x 0.5...1.5 mm ² 2 x 20...16 AWG
 8 mm 0.315"	1 x 0.5...2.5 mm ² 2 x 0.5...1.5 mm ² 1 x 18...14 AWG 2 x 18...16 AWG	2 x 0.5...1.5 mm ² 2 x 18...16 AWG
 8 mm 0.315"	1 x 0.5...2.5 mm ² 2 x 0.5...1.5 mm ² 1 x 18...14 AWG 2 x 18...16 AWG	2 x 0.5...1.5 mm ² 2 x 18...16 AWG
DIN 46228-1-A DIN 46228-4-E		

CONNECT (IN)

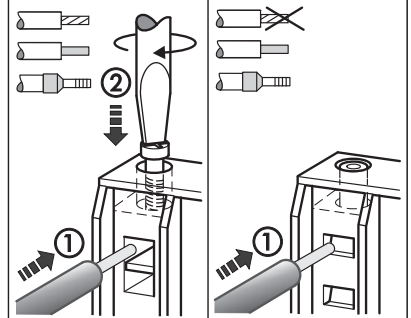

DISCONNECT (OUT)

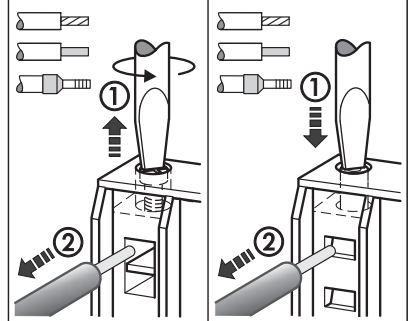

2CDC 252 014 F0015

2CDC 253 007 F0011

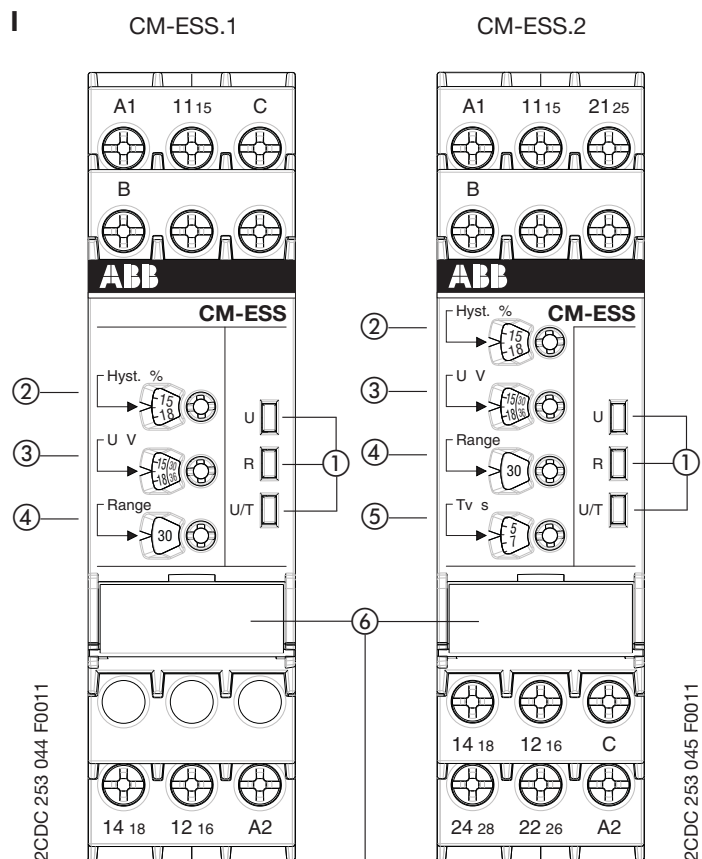

I Frontansicht mit Bedienelementen

- ① Betriebszustandsanzeige mit LEDs
 - U: LED rot - Anzeige der Messspannung
 Schalterstellung -
 Überspannung
 Schalterstellung -
 Unterspannung
 - R: LED gelb - Anzeige der Schaltstellung der Ausgangsrelais
 angezogen
 - U/T: LED grün - Anzeige Steuerspeisespannung und Zeitablauf
 Steuerspeisespannung liegt an
 Auslöseverzögerung T_v aktiv
- ② Einstellung der Rückschaltsschwelle (Hysterese)
- ③ Einstellung des Schwellwertes
- ④ Einstellung des Messbereiches (3-30 V; 6-60 V; 30-300 V; 60-600 V AC/DC)
- ⑤ Einstellung der Auslöseverzögerung T_v (0 s; 0,1-30 s)

Achtung:
 Im Vergleich zur Vorgängerversion wurde die Position der Einstellpotentiometer ④ und ⑤ miteinander vertauscht!

II

Position	2	1
ON ↑		
OFF		

2CDC 252 275 F0005

II DIP-Schalterstellungen

- ⑥ DIP-Schalter zur Einstellung von:
 - 1 ON = Unterspannungsüberwachung
 - OFF = Überspannungsüberwachung
 - 2 Keine Funktion
- Auslieferungszustand:
 Alle DIP-Schalter in Position OFF

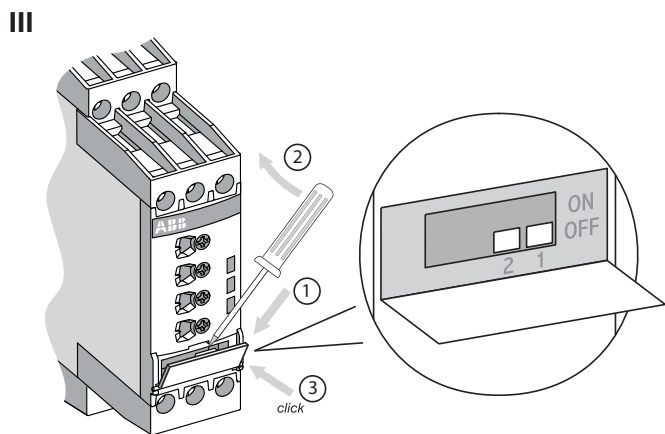



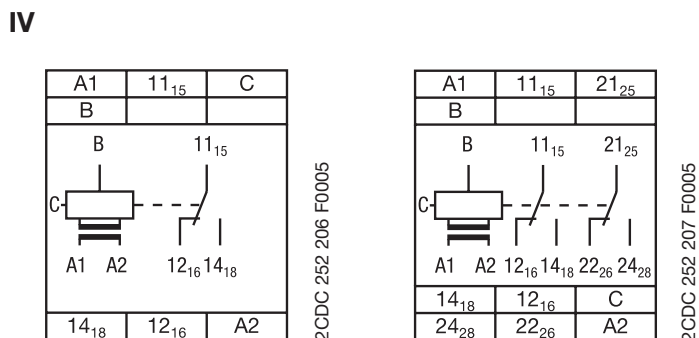



III DIP-Schalterposition



IV Anschlussdiagramm

- A1-A2 Steuerspeisespannung U_s
- B-C Messspannung
- 11(15)-12(16)/14(18) Ausgangsrelais 1
- 21(25)-22(26)/24(28) Ausgangsrelais 2

I Front view with operating controls

- ① Indication of operational states with LEDs
- U: LED red - Status indication of the measured voltage
- Switch position  -
 overvoltage
- Switch position  -
 undervoltage
- R: LED yellow - Status indication of the output relays
-  energized
- U/T: LED green - Status indication of control supply voltage and timing
-  Control supply voltage applied
-  Tripping delay T_V active

- ② Adjustment of the release threshold (hysteresis)
- ③ Adjustment of the threshold value
- ④ Adjustment of the measuring range
(3-30 V; 6-60 V; 30-300 V; 60-600 V AC/DC)
- ⑤ Adjustment of the tripping delay T_V (0 s; 0,1-30 s)

Attention:

When compared with our previous version, the position of the adjustment potentiometers ④ and ⑤ have changed places!

II DIP switch functions

- ⑥ DIP switches for the adjustment of:
- 1 ON = Undervoltage monitoring
OFF = Overvoltage monitoring
- 2 No function

Default setting:







All DIP switches in position OFF

III DIP switch position

IV Connection diagram

A1-A2	Control supply voltage U_s
B-C	Measured voltage
11(15)-12(16)/14(18)	Output relay 1
21(25)-22(26)/24(28)	Output relay 2

I Face avant et dispositifs de commande

- ① Indication de fonctionnement par LED
- U: LED rouge - Indication de la tension de mesure
- Position de l'interrupteur  -
 surtension
- Position de l'interrupteur  -
 sous-tension
- R: LED jaune - Indication de l'état des relais de sortie
-  activés
- U/T: LED verte - Indication de la tension d'alimentation de commande et temporisation
-  Tension d'alimentation de commande appliquée
-  Temporisation de déclenchement T_V active

- ② Réglage de l'hystérésis
- ③ Réglage de la valeur de seuil
- ④ Réglage de la gamme de mesure
(3-30 V; 6-60 V; 30-300 V; 60-600 V AC/DC)
- ⑤ Réglage de la temporisation de déclenchement T_V
(0 s; 0,1-30 s)

Attention:

En comparaison à la version précédente, la position des potentiomètres de réglage ④ et ⑤ a été intervertie!

II Fonctions des micro-interrupteurs

- ⑥ Micro-interrupteurs pour le réglage de:
- 1 ON = Contrôle de sous-tension
OFF = Contrôle de surtension
- 2 Pas de fonction

Etat de livraison:







Tous les micro-interrupteurs en position OFF

III Position des micro-interrupteurs

IV Schéma de connexion

A1-A2	Tension d'alimentation de commande U_s
B-C	Tension de mesure
11(15)-12(16)/14(18)	Relais de sortie 1
21(25)-22(26)/24(28)	Relais de sortie 2

I Vista frontal con elementos de mando

- ① Indicadores de servicio con LEDs
- U: LED rojo - Indicación de la tensión de medida
 Posición interruptor  -
 sobretensión
 Posición interruptor  -
 subtensión
- R: LED amarillo - Indicación del estado de los relés de salida
 energizados
- U/T: LED verde - Indicación tensión de alimentación de mando y temporización
 Tensión de alimentación de mando aplicada
 Retardo de disparo T_v activado
- ② Ajuste del histéresis
- ③ Ajuste del valor umbral
- ④ Ajuste del rango de medida
 (3-30 V; 6-60 V; 30-300 V; 60-600 V AC/DC)
- ⑤ Ajuste del retardo de disparo T_v (0 s; 0,1-30 s)

Atención:

En comparación con la versión anterior, la posición de los potenciómetros de ajuste ④ y ⑤ se ha intercambiado!

II Funciones de los interruptores DIP

- ⑥ Interruptores DIP para el ajuste de:
- 1 ON = Control de subtensión
OFF = Control de sobretensión
 - 2 Ninguna función

Entrega de fábrica:







Todos los interruptores DIP en posición OFF

III Posición de los interruptores DIP

IV Esquema de conexión

A1-A2	Tensión de alimentación de mando U_s
B-C	Tensión de medida
11(15)-12(16)/14(18)	Relé de salida 1
21(25)-22(26)/24(28)	Relé de salida 2

I Vista frontale con gli elementi di comando

- ① LED di visualizzazione dello stato di funzionamento
- U: LED rosso - Indicazione della tensione di misura
 Posizione interruttore  -
 sovratensione
 Posizione interruttore  -
 sottotensione
- R: LED giallo - Indicazione dello stato dei relè d'uscita
 eccitati
- U/T: LED verde - Indicazione tensione di comando e stato della temporizzazione
 Tensione di comando applicata
 ritardo di intervento T_v attivo
- ② Impostazione della soglia di ripristino (isteresi)
- ③ Impostazione del valore di soglia
- ④ Impostazione del campo di misura
 (3-30 V; 6-60 V; 30-300 V; 60-600 V AC/DC)
- ⑤ Impostazione del ritardo di intervento T_v (0 s; 0,1-30 s)

Attenzione:

Rispetto alla versione precedente, la posizione dei potenziometri di impostazione ④ e ⑤ è stata invertita!

II Funzioni degli interruttori DIP

- ⑥ Interruttori DIP per l'impostazione di:
- 1 ON = Controllo di sottotensione
OFF = Controllo di sovratensione
 - 2 Senza funzione

Impostazione di fabbrica:





Tutti gli interruttori DIP in posizione OFF

III Posizione degli interruttori DIP

IV Schema di collegamento

A1-A2	Tensione di comando U_s
B-C	Tensione di misura
11(15)-12(16)/14(18)	Relè di uscita 1
21(25)-22(26)/24(28)	Relè di uscita 2

I Вид спереди на элементы управления

- ① Светодиоды для индикации состояния реле
- U: красный - Индикация состояния измеряемого напряжения
- Положение выключателя  - перенапряжение
- Положение выключателя  - пониженное напряжение
- R: желтый - Индикация состояния выходного реле
- У/T: зеленый - Индикация состояния питающего напряжения и отсчета времени
-  питание включено
-  задержка срабатывания реле T_V включена
- ② Регулировка порога расцепления (гистерезис)
- ③ Регулировка значения порога срабатывания
- ④ Регулировка измеряемого диапазона (3-30 В; 6-60 В; 30-300 В; 60-600 В AC/DC)
- ⑤ Регулировка задержки срабатывания реле. T_V (0 с; 0,1-30 с)

Внимание:

По сравнению с предыдущей версией положение регулировочных потенциометров ④ и ⑤ было изменено!

II Функции DIP-переключателей

- ⑥ DIP-переключатели для настройки:
- 1 ON = контроль пониженного напряжения
OFF = контроль перенапряжения
- 2 нет функций





Состояние поставки: BCE DIP-переключатели установлены в положении ВЫКЛ.

III Положения DIP-переключателей

IV Схема соединений

A1-A2	Питающее напряжение U_s
B-C	Измеряемое напряжение
11(15)-12(16)/14(18)	Выходное реле 1
21(25)-22(26)/24(28)	Выходное реле 2

I 前面板操作

- ① LED状态指示
- U: 红色LED - 测量电压的状态指示
- 动作位置  - 过电压
- 动作位置  - 欠电压
- R: 黄色LED - 输出继电器的动作状态指示
- 动作 
- U/T: 绿色LED - 控制供电电压和定时的状态指示
-  控制供电电压上电
-  动作延时 T_V 有效
- ② 释放阈值调节 (磁滞)
- ③ 阈值调节
- ④ 测量范围调节 (3-30 V; 6-60 V; 30-300 V; 60-600 V AC/DC)
- ⑤ 动作延时时间 T_V 调节 (0 s; 0,1-30 s)

注意:

和我们的上一版产品相比, 新版产品的电位计④和⑤的位置改变了!

II DIP开关功能

- ⑥ DIP开关调节:
- 1 ON = 欠电压监视
OFF = 过电压监视
- 2 ON = 无功能

默认设置:

所有DIP开关处于OFF位置。

III DIP开关位置

IV 接线图

A1-A2	控制供电电压 U_s
B-C	测量电压
11(15)-12(16)/14(18)	输出继电器 1
21(25)-22(26)/24(28)	输出继电器 2

Function diagrams

V Overvoltage monitoring, CM-ESS.1

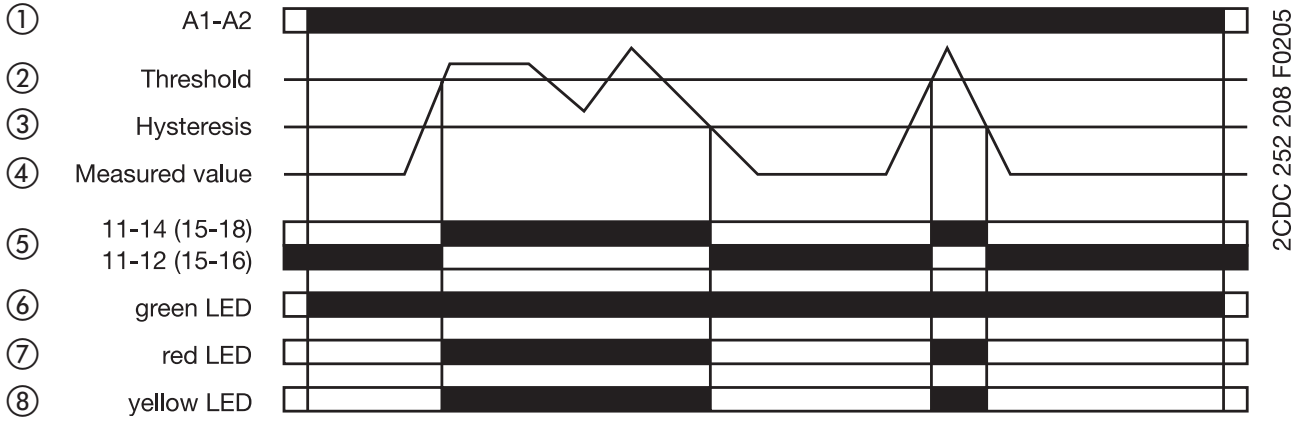

VI Undervoltage monitoring, CM-ESS.1

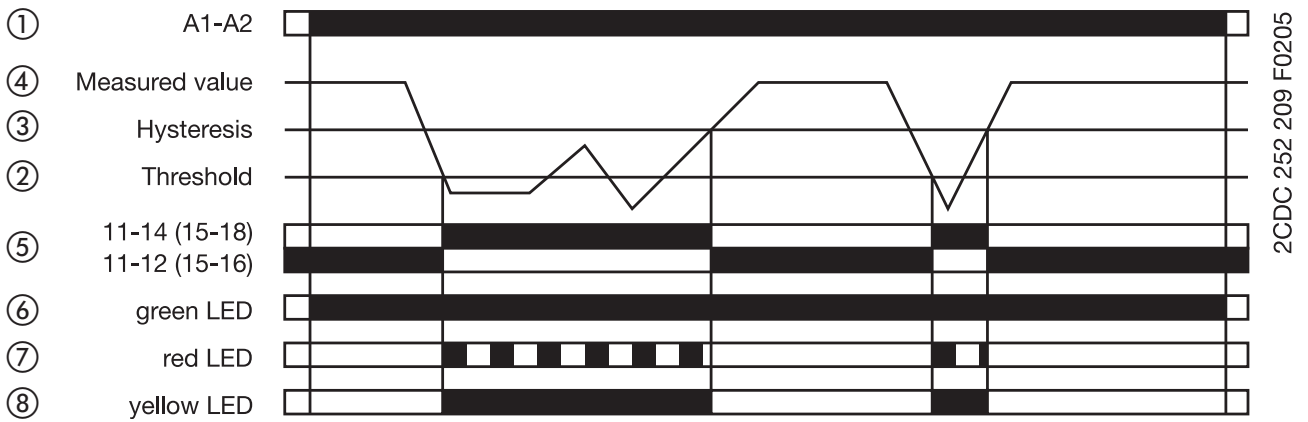

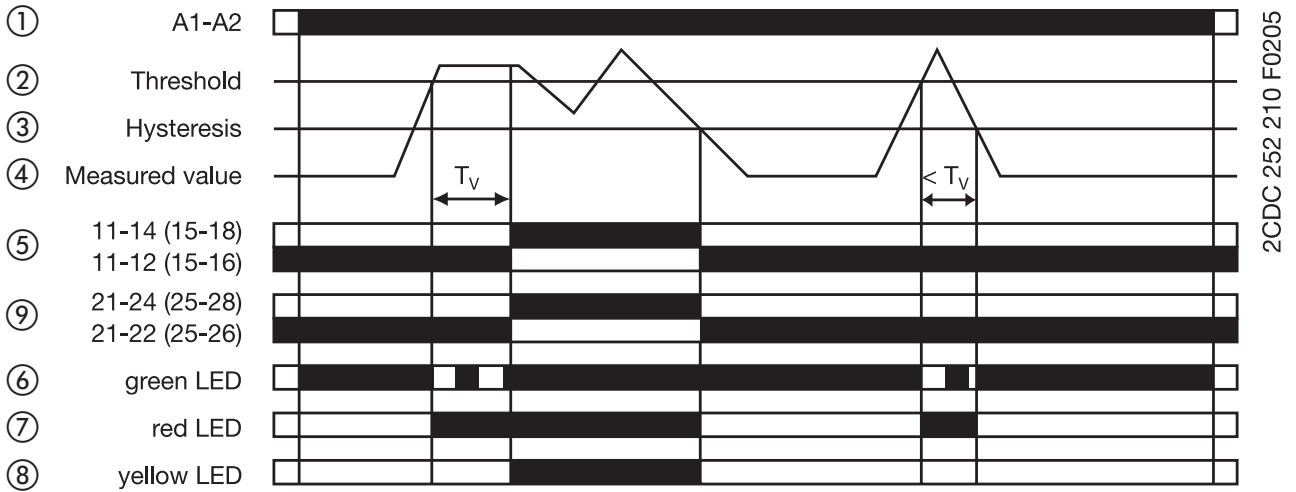

VII Overvoltage monitoring, CM-ESS.2

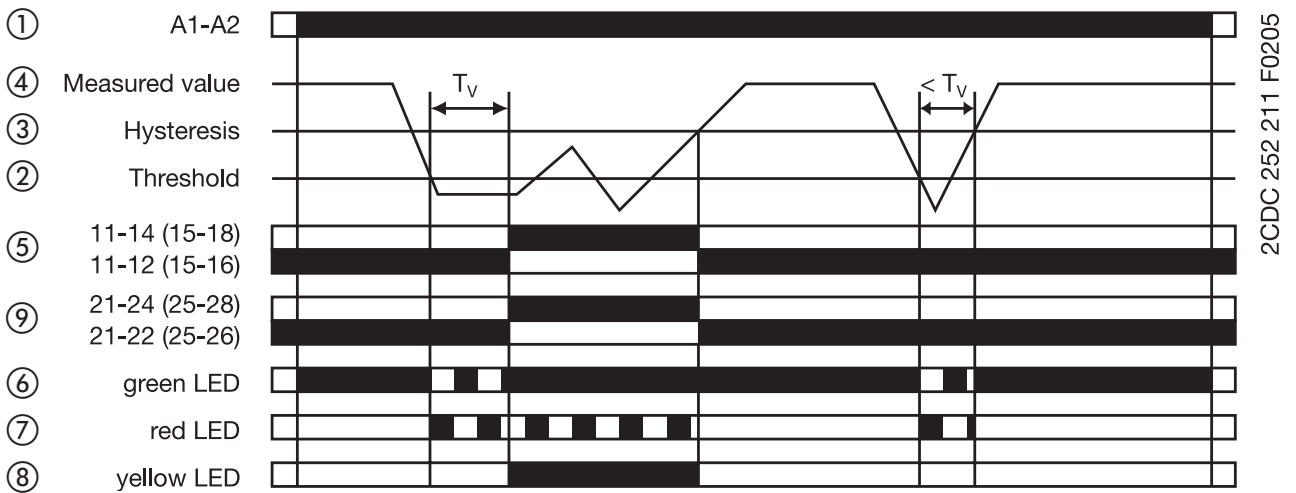

VIII Undervoltage monitoring, CM-ESS.2



Arbeitsweise

Die Spannungsüberwachungsrelais CM-ESS.1 und CM-ESS.2 können in einphasigen AC- oder DC-Netzen je nach Konfiguration zur Über-  oder Unterspannungsüberwachung  eingesetzt werden. Die zu überwachende Spannung (Messwert) wird dazu an den Klemmen B-C eingespeist. Die Geräte arbeiten nach dem Arbeitsstromprinzip.

CM-ESS.1: Über- bzw. unterschreitet der Messwert den eingestellten Schwellwert, zieht das (ziehen die) Ausgangsrelais unverzüglich an.

CM-ESS.2: Über- bzw. unterschreitet der Messwert den eingestellten Schwellwert wird die Auslöseverzögerung T_v gestartet. Befindet sich der Messwert nach Ablauf von T_v noch über bzw. unter dem Schwellwert minus bzw. plus der eingestellten Hysterese, ziehen die Ausgangsrelais an.

Unter- bzw. überschreitet der Messwert den Schwellwert minus bzw. plus die eingestellte Hysterese, fällt das (fallen die) Ausgangsrelais in seine (ihre) Ruhestellung zurück.



Die Hysterese ist in einem Bereich von 3-30 % des Schwellwerts einstellbar.

Funktionsdiagramme

- V Überspannungsüberwachung, CM-ESS.1
- VI Unterspannungsüberwachung, CM-ESS.1
- VII Überspannungsüberwachung, CM-ESS.2
- VIII Unterspannungsüberwachung, CM-ESS.2

- ① Steuerspeisespannung
- ② Schwellwert
- ③ Hysterese
- ④ Messwert
- ⑤ Ausgangsrelais 1
- ⑥ LED grün
- ⑦ LED rot
- ⑧ LED gelb
- ⑨ Ausgangsrelais 2

Operating principle

Depending on the configuration, the voltage monitoring relays CM-ESS.1 and CM-ESS.2 can be used for over-  or undervoltage monitoring  in single-phase AC or DC systems. The voltage to be monitored (measured value) is applied to terminals B-C. The devices work according the open-circuit principle.

CM-ESS.1: If the measured value exceeds resp. drops below the adjusted threshold value, the output relay(s) energize(s) immediately.

CM-ESS.2: If the measured value exceeds or drops below the adjusted threshold value, the tripping delay T_V starts. If T_V is complete and the measured value is still exceeding or below the threshold value minus / plus the set hysteresis, the output relays energize.

If the measured value exceeds resp. drops below the threshold value plus resp. minus the adjusted hysteresis, the output relay(s) de-energize(s).



The hysteresis is adjustable within a range of 3-30 % of the threshold value.

Function diagrams

- V Overvoltage monitoring, CM-ESS.1
- VI Undervoltage monitoring, CM-ESS.1
- VII Overvoltage monitoring, CM-ESS.2
- VIII Undervoltage monitoring, CM-ESS.2

- ① Control supply voltage
- ② Threshold value
- ③ Hysteresis
- ④ Measured value
- ⑤ Output relay 1
- ⑥ green LED
- ⑦ red LED
- ⑧ yellow LED
- ⑨ Output relay 2

Principe de fonctionnement

Selon la configuration, les contrôleurs de tension CM-ESS.1 et CM-ESS.2 peuvent être utilisés pour surveiller une sur-  ou sous-tension  dans des réseaux monophasés AC ou DC. La tension de mesure (valeur mesurée) est appliquée aux bornes B-C. Les relais fonctionnent en logique positive.

CM-ESS.1: Si la valeur mesurée dépasse ou chute en dessous de la valeur de seuil ajustée, le (les) relais de sortie s'active(nt) sans temporisation.

CM-ESS.2: Si la valeur mesurée dépasse ou chute en dessous de la valeur de seuil ajustée, la temporisation de déclenchement T_V commence. Si, après la fin de T_V , la valeur mesurée se trouve encore en dessus ou en dessous de la valeur de seuil moins ou plus l'hystérésis ajustée, les relais de sortie s'activent.



Le(s) relais de sortie se désactive(nt), si la valeur mesurée dépasse ou chute en dessous de la valeur de seuil plus ou moins l'hystérésis ajustée.

L'hystérésis est ajustable dans une gamme de 3-30 % de la valeur de seuil.

Diagrammes de fonctionnement

- V Contrôle de surtension, CM-ESS.1
 - VI Contrôle de sous-tension, CM-ESS.1
 - VII Contrôle de surtension, CM-ESS.2
 - VIII Contrôle de sous-tension, CM-ESS.2
- ① Tension d'alimentation de commande
 - ② Valeur de seuil
 - ③ Hystérésis
 - ④ Valeur mesurée
 - ⑤ Relais de sortie 1
 - ⑥ LED verte
 - ⑦ LED rouge
 - ⑧ LED jaune
 - ⑨ Relais de sortie 2

Funcionamiento

Dependiendo de la configuración, los relés de control de tensión CM-ESS.1 y CM-ESS.2 pueden utilizarse para sobre-  o subtensión  en redes monofásicas de CA o de CC. La tensión de medida (valor medido) se aplica a los terminales B-C. Los dispositivos funcionan de acuerdo al principio de circuito abierto.

CM-ESS.1: Si el valor medido, respectivamente, excede o cae por debajo del valor umbral ajustado, el/los relé(s) de salida se energiza(n) inmediatamente.

CM-ESS.2: El retardo de disparo T_v empieza si el valor medido excede o cae por debajo del valor umbral. Si T_v se ha completado y el valor medido sigue por encima o por debajo del valor umbral ajustado, menos/más el valor ajustado de histéresis, los relés de salida se energizan.

Si el valor medido, respectivamente, excede o cae por debajo del valor umbral ajustado más/menos la histéresis ajustada, el/los relé(s) de salida se des-energiza(n).

La histéresis es ajustable en el rango de 3-30% del valor umbral.

Diagramas de funcionamiento

V Control de sobretensión, CM-ESS.1



VI Control de subtensión, CM-ESS.1

VII Control de sobretensión, CM-ESS.2

VIII Control de subtensión, CM-ESS.2

- ① Tensión de alimentación de mando
- ② Valor umbral
- ③ Hystéresis
- ④ Valor medido
- ⑤ Relé de salida 1
- ⑥ LED verde
- ⑦ LED rojo
- ⑧ LED amarillo
- ⑨ Relé de salida 2

Funzionamento

A seconda della configurazione, i relè di controllo di tensione CM-ESS.1 e CM-ESS.2 possono essere utilizzati per controllare sovra-  o sottotensione  in sistemi CA/CC monofasi. La tensione da controllare (valore misurato) viene applicata ai morsetti B-C. Gli apparecchi lavorano a secondo del principio di funzionamento normalmente aperto.

CM-ESS.1: Se il valore misurato aumenta o diminuisce oltre il valore di soglia impostato, i/il relè di uscita si eccita(no) senza ritardo.

CM-ESS.2: Se il valore misurato aumenta o diminuisce oltre il valore di soglia impostato, il ritardo di intervento T_v inizia. Se, dopo che è trascorso il tempo T_v , il valore misurato è ancora superiore o inferiore al valore di soglia meno o più l'isteresi impostata, i relè di uscita si eccitano.

Se il valore misurato diminuisce o aumenta oltre il valore di soglia meno o più l'isteresi impostata, i/il relè si diseccita(no) nuovamente.

L'isteresi è regolabile nel range da 3-30 % del valore di soglia.

Diagrammi di funzionamento

V Controllo di sovratensione, CM-ESS.1



VI Controllo di sottotensione, CM-ESS.1

VII Controllo di sovratensione, CM-ESS.2

VIII Controllo di sottotensione, CM-ESS.2

- ① Tensione di comando
- ② Valore di soglia
- ③ Isteresi
- ④ Valore misurato
- ⑤ Relè di uscita 1
- ⑥ LED verde
- ⑦ LED rosso
- ⑧ LED giallo
- ⑨ Relè di uscita 2

Принцип работы

В зависимости от конфигурации реле контроля напряжения CM-ESS.1 и CM-ESS.2 могут использоваться для контроля перенапряжения  или пониженного напряжения  в однофазных сетях постоянного или переменного тока. Контролируемое напряжение (измеряемое значение) подается на клеммы В-С. Устройство работает по принципу разомкнутой цепи.

CM-ESS.1: Если измеряемое значение превысит или опустится ниже заданной величины, то выходное(ые) реле активируе(ю)тся мгновенно.

CM-ESS.2: Если измеряемое значение превысит или опустится ниже заданной величины, тогда начнется отсчет выдержки времени T_v . Если, по прошествии выдержки времени T_v измеряемая величина превышает или находится ниже заданной величины плюс гистерезис, тогда выходные реле активируются.



Если измеряемое значение возвращается в заданные пределы, т.е. превышает минимальный порог/опускается ниже максимального порога на величину заданного гистерезиса, то выходно(ы)е реле обесточивае(ю)тся. Гистерезис регулируется в диапазоне 3-30 % порогового значения.

Функциональные схемы

- V Контроль перенапряжения, CM-ESS.1
- VI Контроль пониженного напряжения, CM-ESS.1
- VII Контроль перенапряжения, CM-ESS.2
- VIII Контроль пониженного напряжения, CM-ESS.2

- ① Питающее напряжение
- ② Пороговое значение
- ③ Гистерезис
- ④ Измеряемое значение
- ⑤ Выходное реле 1
- ⑥ Зеленый светодиод
- ⑦ Красный светодиод
- ⑧ Желтый светодиод
- ⑨ Выходное реле 2

工作原理

根据设置，电压监视继电器CM-ESS.1和CM-ESS.2可用于单相交流或直流系统的过电压监视或欠电压监视。被监视的电压（测量值）接到端子B-C。模块根据开路原则工作。

CM-ESS.1: 若测量值超过（或低于）设定的阈值，输出继电器立即复位。

CM-ESS.2: 若测量值超过或低于设定的阈值，动作延时 T_v 计时开始。若 T_v 计时结束且测量值仍大于或小于阈值减去/加上设定的磁滞，输出继电器动作。

若测量值超过或低于设定阈值加上或减去设定磁滞，输出继电器复位。

磁滞可在阈值的3-30%范围内调节。

功能图

- V 过电压监视CM-ESS.1
- VI 欠电压监视CM-ESS.1
- VII 过电压监视CM-ESS.2
- VIII 欠电压监视CM-ESS.2

- ① 控制供电电压
- ② 阈值
- ③ 磁滞
- ④ 测量值
- ⑤ 输出继电器1
- ⑥ 绿色 LED
- ⑦ 红色 LED
- ⑧ 黄色 LED
- ⑨ 输出继电器2

CM-ESS.M



(DE) Betriebs- und Montageanleitung

Einphasige Spannungsüberwachungsrelais, CM Reihe

Hinweis: Diese Betriebs- und Montageanleitung enthält nicht sämtliche Detailinformationen zu allen Typen der Produktreihe und kann auch nicht jeden Einsatzfall der Produkte berücksichtigen. Alle Angaben dienen ausschließlich der Produktbeschreibung und sind nicht als vertraglich vereinbarte Beschaffenheit aufzufassen. Weiterführende Informationen und Daten erhalten Sie in den Katalogen und Datenblättern der Produkte, über die örtliche ABB-Niederlassung sowie auf der ABB Homepage unter www.abb.com. Technische Änderungen jederzeit vorbehalten. In Zweifelsfällen gilt der deutsche Text.



Warnung! Gefährliche Spannung! Installation nur durch elektrotechnische Fachkraft. Landes-spezifische Vorschriften (z.B. VDE, etc.) beachten. Vor der Installation diese Betriebs- und Montageanleitung sorgfältig lesen und beachten. An die nicht beschrifteten Klemmen darf kein Leiter angeschlossen werden.

(EN) Operating and installation instructions

Single-phase voltage monitoring relays, CM range

Note: These operating and installation instructions cannot claim to contain all detailed information of all types of this product range and can even not consider every possible application of the products. All statements serve exclusively to describe the product and have not to be understood as contractually agreed characteristics. Further information and data is obtainable from the catalogues and data sheets of this product, from the local ABB sales organisations as well as on the ABB homepage www.abb.com. Subject to change without prior notice. The German text applies in cases of doubt.



Warning! Hazardous voltage! Installation by person with electrotechnical expertise only and in accordance with the specific national regulations (e.g., VDE, etc). Before installing this unit, read these operating and installation instructions carefully and completely. Do not connect any conductor to terminals not labelled.

(FR) Instructions de montage et de mise en service

Contrôleurs de tension monophasée, gamme CM

Note: Ces instructions de service et de montage ne contiennent pas toutes les informations relatives à tous les types de cette gamme de produits et ne peuvent pas non plus tenir compte de tous les cas d'application. Toutes les indications ne sont données qu'à titre de description du produit et ne constituent aucune obligation contractuelle. Pour de plus amples informations, veuillez-vous référer aux catalogues et aux fiches techniques des produits, à votre agence ABB ou sur notre site www.abb.com. Sous réserve de modifications techniques. En cas de divergences, le texte allemand fait foi.



Avertissement! Tension électrique dangereuse! Installation uniquement par des personnes qualifiées en électrotechnique et en conformité avec les prescriptions nationales (p.e. VDE, etc.). Avant l'installation de cet appareil veuillez lire l'intégralité de ces instructions. Ne pas connecter de conducteur aux bornes non marquées.

(ES) Instrucciones de montaje y de servicio

Relés de control de tensión monofásica, serie CM

Nota: Estas instrucciones no contienen todas las informaciones detalladas relativas a todos los tipos del producto ni pueden considerar todos los casos de operación. Todas las indicaciones son a título descriptivo del producto y no constituyen ninguna obligación contractual. Para más información, consulte los catálogos, las hojas de características, la sucursal local de ABB o la Web www.abb.com. Sujeto a cambios técnicos sin previo aviso. En caso de duda, prevalece el texto alemán.



¡Advertencia! ¡Tensión peligrosa! La instalación deberá ser realizada únicamente por electricistas especializados. Es necesario respetar las normas específicas del país (p.ej. VDE, etc.). Antes de la instalación lea completamente estas instrucciones. No conectar ningún conductor a los bornes no marcados.

(IT) Istruzioni per l'uso ed il montaggio

Relè di controllo di tensione monofase, serie CM

Nota: Le presenti istruzioni per l'uso ed il montaggio non contengono tutte le informazioni di dettaglio sull'intera gamma di prodotti e non possono trattare tutti i casi applicativi. Tutte le indicazioni servono esclusivamente a descrivere il prodotto e non costituiscono alcuna obbligazione contrattuale. Per ulteriori informazioni consultare i cataloghi ed i data sheet dei prodotti, o la nostra homepage www.abb.com, oppure rivolgersi alla filiale locale di ABB. Ci riserviamo il diritto di effettuare eventuali modifiche tecniche. In caso di discrepanze o fraintendimenti fa fede il testo in lingua tedesca.



Avvertenza! Tensione pericolosa! Far installare solo da un elettricista specializzato. Bisogna osservare le specifiche norme nazionali p.e. VDE, etc.). Prima dell'installazione leggere attentamente le seguenti istruzioni. Non collegare nessun conduttore ai morsetti non marcati.

(RU) Инструкция по установке и эксплуатации

Однофазное реле контроля напряжения, серия CM

Примечание: Настоящая инструкция по установке и эксплуатации не претендует на полноту содержащейся здесь информации по всем типам изделий серии и не рассматривает все возможности применения настоящего изделия. Вся информация служит исключительно для его описания и не должна рассматриваться в качестве гарантированных характеристик, имеющих юридическую силу. Дополнительную информацию и данные можно получить из каталогов и листа тех. данных на настоящее изделие в местном представительстве компании ABB, а также на сайте компании ABB по адресу: www.abb.com. Возможны изменения без предварительного уведомления. При возникновении сомнений текст на немецком языке имеет приоритет.



Осторожно! Опасное напряжение! Монтаж должен выполняться только специалистом-электриком в соответствии с нормативным законодательством (т.к. VDE, итд). Перед установкой элемента внимательно ознакомьтесь с инструкцией. Не подключайте провода к клеммам, не имеющий обозначений.

(ZH) 操作与安装指南

单相电压监视继电器，CM系列

注意：本操作指南不包含技术数据和全部应用说明，所有数据只是具有对产品特性进行说明的作用，因此不具备法律效应。详细说明请参阅技术样本或联络ABB当地办事处或浏览ABB网站 (www.abb.com)。如有更改恕不通知。并以德文为标准。



警告！危险电压！ 仅可由电气专业人员安装且需符合特定的国家规定（如VDE等）。安装前，请仔细且全部阅读该安装说明。无标识的端子不可接线。

Technical data:

T_a: -20 ... +60 °C (-4 ... +140 °F)

IP 20

Pollution degree 3

Additional information relating to cULus approval:

For use in pollution degree 2 environment

Information complémentaire relative à la certification cULus:

Pour utilisation dans un environnement de degré de pollution 2

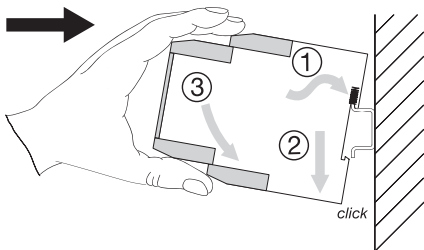

2CDC 253 012 F0014

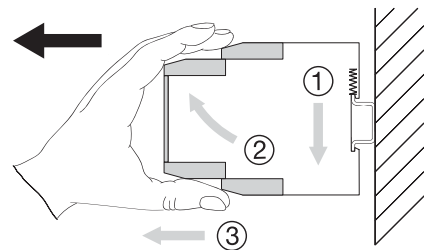

2CDC 253 013 F0014

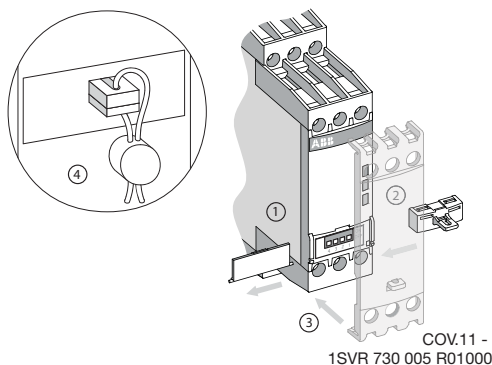

2CDC 253 025 F0014

CM-ESS.xyS

CM-ESS.xyP

DIN ISO 2380-1 Form A 0.8 x 4 mm / 0.0315 x 0.157 in DIN ISO 8764-1 PZ 1 Ø 4.5 mm / 0.177 in	 0.6...0.8 Nm 7.08 lb.in	
 8 mm 0.315"	1 x 0.5...4.0 mm ² 2 x 0.5...2.5 mm ² 1 x 20...12 AWG 2 x 20...14 AWG	2 x 0.5...1.5 mm ² 2 x 20...16 AWG
 8 mm 0.315"	1 x 0.5...2.5 mm ² 2 x 0.5...1.5 mm ² 1 x 18...14 AWG 2 x 18...16 AWG	2 x 0.5...1.5 mm ² 2 x 18...16 AWG
 8 mm 0.315"	1 x 0.5...2.5 mm ² 2 x 0.5...1.5 mm ² 1 x 18...14 AWG 2 x 18...16 AWG	2 x 0.5...1.5 mm ² 2 x 18...16 AWG
DIN 46228-1-A DIN 46228-4-E		

CONNECT (IN)

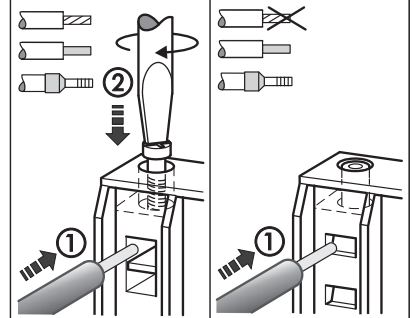

DISCONNECT (OUT)

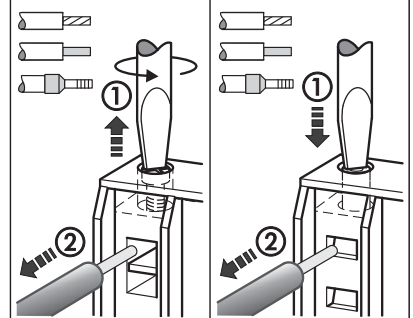

2CDC 252 014 F0015

2CDC 253 007 F0011

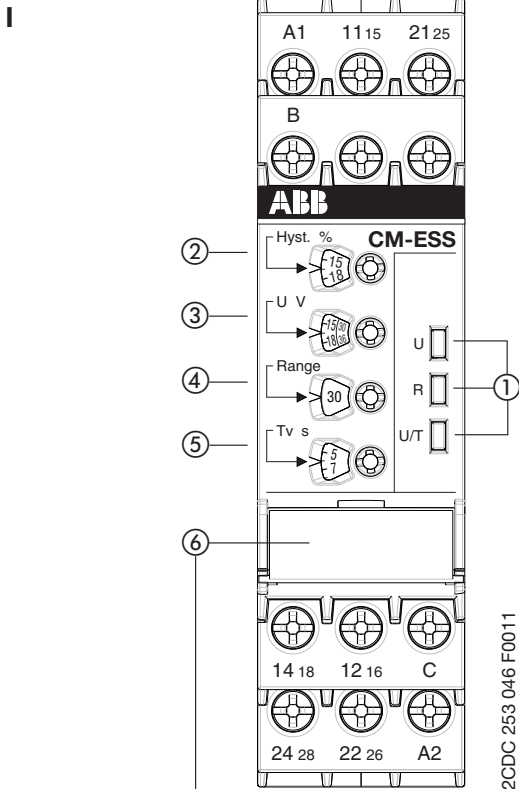

Position	4	3	2	1
ON ↑			closed	
OFF			open	

2CDC 252 276 F0005

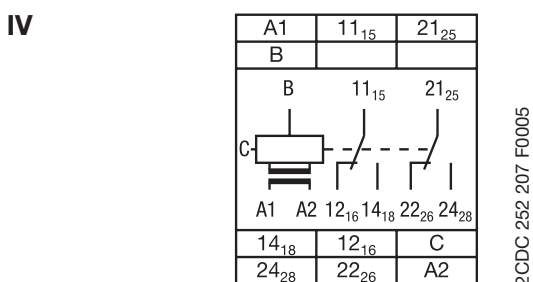
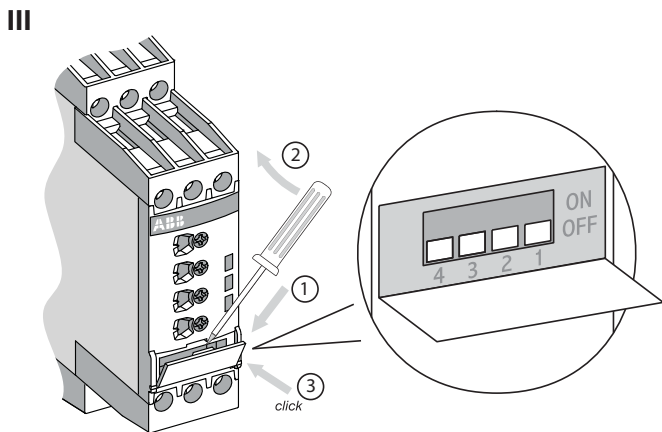

I Frontansicht mit Bedienelementen

- ① Betriebszustandsanzeige mit LEDs
 - U: LED rot - Anzeige der Messspannung
 - Schalterstellung -
 - Überspannung
 - Schalterstellung -
 - Unterspannung
 - R: LED gelb - Anzeige der Schaltstellung der Ausgangsrelais
 - angezogen
 - angezogen,
 - abgefallen,
 - U/T: LED grün - Anzeige Speisespannung und Zeitablauf
 - Speisespannung liegt an
 - Auslöseverzögerung T_V aktiv
- ② Einstellung der Rückschaltsschwelle (Hysterese)
- ③ Einstellung des Schwellwertes
- ④ Einstellung des Messbereiches (3-30 V; 6-60 V; 30-300 V; 60-600 V AC/DC)
- ⑤ Einstellung der Auslöseverzögerung T_V (0 s; 0,1-30 s)

Achtung:
Im Vergleich zur Vorgängerversion wurde die Position der Einstellpotentiometer ④ und ⑤ miteinander vertauscht!

II DIP-Schalterstellungen

- ⑥ DIP-Schalter zur Einstellung von:
 - 1 ON = Unterspannungsüberwachung
OFF = Überspannungsüberwachung
 - 2 ON = Ruhestromprinzip
OFF = Arbeitsstromprinzip
 - 3 ON = Speicherung ein
OFF = Speicherung aus
 - 4 Keine Funktion











Auslieferungszustand:
Alle DIP-Schalter in Position OFF

III DIP-Schalterposition

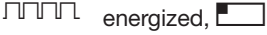
IV Anschlussdiagramm

- A1-A2 Speisespannung U_s
- B-C Messspannung
- 11(15)-12(16)/14(18) Ausgangsrelais 1
- 21(25)-22(26)/24(28) Ausgangsrelais 2

I Front view with operating controls

- ① Indication of operational states with LEDs
- U: LED red - Status indication of the measured voltage
- Switch position  -
 overvoltage
- Switch position  -
 undervoltage
- R: LED yellow - Status indication of the output relays
-  energized
-  energized, 
-  de-energized, 
- U/T: LED green - Status indication of control supply voltage and timing
-  Control supply voltage applied
-  Tripping delay T_V active

- ② Adjustment of the release threshold (hysteresis)
- ③ Adjustment of the threshold value
- ④ Adjustment of the measuring range
(3-30 V; 6-60 V; 30-300 V; 60-600 V AC/DC)
- ⑤ Adjustment of the tripping delay T_V (0 s; 0,1-30 s)

Attention:

When compared with our previous version, the position of the adjustment potentiometers ④ and ⑤ have changed places!

II DIP switch functions

- ⑥ DIP switches for the adjustment of:
- ON = Undervoltage monitoring
OFF = Overvoltage monitoring
 - ON = Closed-circuit principle
OFF = Open-circuit principle
 - ON = Latching function ON
OFF = Latching function OFF
 - No function

Default setting:











All DIP switches in position OFF

III DIP switch position

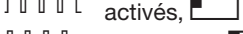
IV Connection diagram

A1-A2	Control supply voltage U_s
B-C	Measured voltage
11(15)-12(16)/14(18)	Output relay 1
21(25)-22(26)/24(28)	Output relay 2

I Face avant et dispositifs de commande

- ① Indication de fonctionnement par LED
- U: LED rouge - Indication de la tension de mesure
- Position de l'interrupteur  -
 surtension
- Position de l'interrupteur  -
 sous-tension
- R: LED jaune - Indication de l'état des relais de sortie
-  activés
-  activés, 
-  désactivés, 
- U/T: LED verte - Indication de la tension d'alimentation de commande et temporisation
-  Tension d'alimentation de commande appliquée
-  Temporisation de déclenchement T_V active

- ② Réglage de l'hystérésis
- ③ Réglage de la valeur de seuil
- ④ Réglage de la gamme de mesure
(3-30 V; 6-60 V; 30-300 V; 60-600 V AC/DC)
- ⑤ Réglage de la temporisation de déclenchement T_V
(0 s; 0,1-30 s)

Attention:

En comparaison à la version précédente, la position des potentiomètres de réglage ④ et ⑤ a été intervertie!

II Fonctions des micro-interrupteurs

- ⑥ Micro-interrupteurs pour le réglage de:
- ON = Contrôle de sous-tension
OFF = Contrôle de surtension
 - ON = Fonctionnement en logique négative
OFF = Fonctionnement en logique positive
 - ON = Mémorisation activée
OFF = Sans mémorisation
 - Pas de fonction

Etat de livraison:











Tous les micro-interrupteurs en position OFF

III Position des micro-interrupteurs

IV Schéma de connexion

A1-A2	Tension d'alimentation de commande U_s
B-C	Tension de mesure
11(15)-12(16)/14(18)	Relais de sortie 1
21(25)-22(26)/24(28)	Relais de sortie 2

I Vista frontal con elementos de mando

- ① Indicadores de servicio con LEDs
- U: LED rojo - Indicación de la tensión de medida
- Posición interruptor  -
 sobretensión
- Posición interruptor  -
 subtensión
- R: LED amarillo - Indicación del estado de los relés de salida
-  energizados
 energizados, 
 des-energizados, 
- U/T: LED verde - Indicación tensión de alimentación de mando y temporización
-  Tensión de alimentación de mando aplicada
 Retardo de disparo T_v activado
- ② Ajuste del histéresis
- ③ Ajuste del valor umbral
- ④ Ajuste del rango de medida
 (3-30 V; 6-60 V; 30-300 V; 60-600 V AC/DC)
- ⑤ Ajuste del retardo de disparo T_v (0 s; 0,1-30 s)

Atención:

En comparación con la versión anterior, la posición de los potenciómetros de ajuste ④ y ⑤ se ha intercambiado!

II Funciones de los interruptores DIP

- ⑥ Interruptores DIP para el ajuste de:
- ON = Control de subtensión
OFF = Control de sobretensión
 - ON = Principio de circuito cerrado
OFF = Principio de circuito abierto
 - ON = Función de retención activada
OFF = Función de retención desactivada
 - Ninguna función

Entrega de fábrica:











Todos los interruptores DIP en posición OFF

III Posición de los interruptores DIP

IV Esquema de conexión

A1-A2	Tensión de alimentación de mando U_s
B-C	Tensión de medida
11(15)-12(16)/14(18)	Relé de salida 1
21(25)-22(26)/24(28)	Relé de salida 2

I Vista frontale con gli elementi di comando

- ① LED di visualizzazione dello stato di funzionamento
- U: LED rosso - Indicazione della tensione di misura
- Posizione interruttore  -
 sovratensione
- Posizione interruttore  -
 sottotensione
- R: LED giallo - Indicazione dello stato dei relè d'uscita
-  eccitati
 eccitati, 
 diseccitati, 
- U/T: LED verde - Indicazione tensione di comando e stato della temporizzazione
-  Tensione di comando applicata
 ritardo di intervento T_v attivo
- ② Impostazione della soglia di ripristino (isteresi)
- ③ Impostazione del valore di soglia
- ④ Impostazione del campo di misura
 (3-30 V; 6-60 V; 30-300 V; 60-600 V AC/DC)
- ⑤ Impostazione del ritardo di intervento T_v (0 s; 0,1-30 s)

Attenzione:

Rispetto alla versione precedente, la posizione dei potenziometri di impostazione ④ e ⑤ è stata invertita!

II Funzioni degli interruttori DIP

- ⑥ Interruttori DIP per l'impostazione di:
- ON = Controllo di sottotensione
OFF = Controllo di sovratensione
 - ON = Funzionamento normalmente chiuso
OFF = Funzionamento normalmente aperto
 - ON = Memorizzazione ON
OFF = Memorizzazione OFF
 - Senza funzione

Impostazione di fabbrica:









Tutti gli interruttori DIP in posizione OFF

III Posizione degli interruttori DIP

IV Schema di collegamento

A1-A2	Tensione di comando U_s
B-C	Tensione di misura
11(15)-12(16)/14(18)	Relè di uscita 1
21(25)-22(26)/24(28)	Relè di uscita 2

I Вид спереди на элементы управления

- ① Светодиоды для индикации состояния реле
- U: красный - Индикация состояния измеряемого напряжения
- Положение выключателя  - перенапряжение
- Положение выключателя  - пониженное напряжение
- R: желтый - Индикация состояния выходного реле
-  под напряжением
-  под напряжением, 
-  обесточено, 
- U/T: зеленый - Индикация состояния питающего напряжения и отсчета времени
-  питание включено
-  задержка срабатывания реле T_v включена
- ② Регулировка порога расцепления (гистерезис)
- ③ Регулировка значения порога срабатывания
- ④ Регулировка измеряемого диапазона (3-30 В; 6-60 В; 30-300 В; 60-600 В AC/DC)
- ⑤ Регулировка задержки срабатывания реле. T_v (0; 0,1-30 с)

Внимание:

По сравнению с предыдущей версией положение регулировочных потенциометров ④ и ⑤ было изменено!

II Функции DIP-переключателей

- ⑥ DIP-переключатели для настройки:
- ON = контроль пониженного напряжения
OFF = контроль перенапряжения
 - ON = принцип замкнутой цепи
OFF = принцип разомкнутой цепи
 - ON = функция памяти ВКЛ.
OFF = функция памяти ВЫКЛ.
 - нет функций









Состояние поставки: ВСЕ DIP-переключатели установлены в положении ВЫКЛ.

III Положения DIP-переключателей

IV Схема соединений

A1-A2	Питающее напряжение U_s
B-C	Измеряемое напряжение
11(15)-12(16)/14(18)	Выходное реле 1
21(25)-22(26)/24(28)	Выходное реле 2

I 前面板操作

- ① LED状态指示
- U: 红色LED - 测量电压的状态指示
- 动作位置  - 过电压
- 动作位置  - 欠电压
- R: 黄色LED - 输出继电器的动作状态指示
-  动作
-  动作, 
-  复位, 
- U/T: 绿色LED - 控制供电电压和定时的状态指示
-  控制供电电压上电
-  动作延时 T_v 有效
- ② 释放阈值调节 (磁滞)
- ③ 阈值调节
- ④ 测量范围调节 (3-30 V; 6-60 V; 30-300 V; 60-600 V AC/DC)
- ⑤ 动作延时时间 T_v 调节 (0 s; 0,1-30 s)

注意:

和我们的上一版产品相比, 新版产品的电位计④和⑤的位置改变了!

II DIP开关功能

- ⑥ DIP开关调节:
- ON = 欠电压监视
OFF = 过电压监视
 - ON = 闭路原则
OFF = 开路原则
 - ON = 故障保持功能有效
OFF = 故障保持功能无效
 - ON = 无功能

默认设置:

所有DIP开关处于OFF位置。

III DIP开关位置

IV 接线图

A1-A2	控制供电电压 U_s
B-C	测量电压
11(15)-12(16)/14(18)	输出继电器 1
21(25)-22(26)/24(28)	输出继电器 2

Function diagrams

V Overtvoltage monitoring without latching

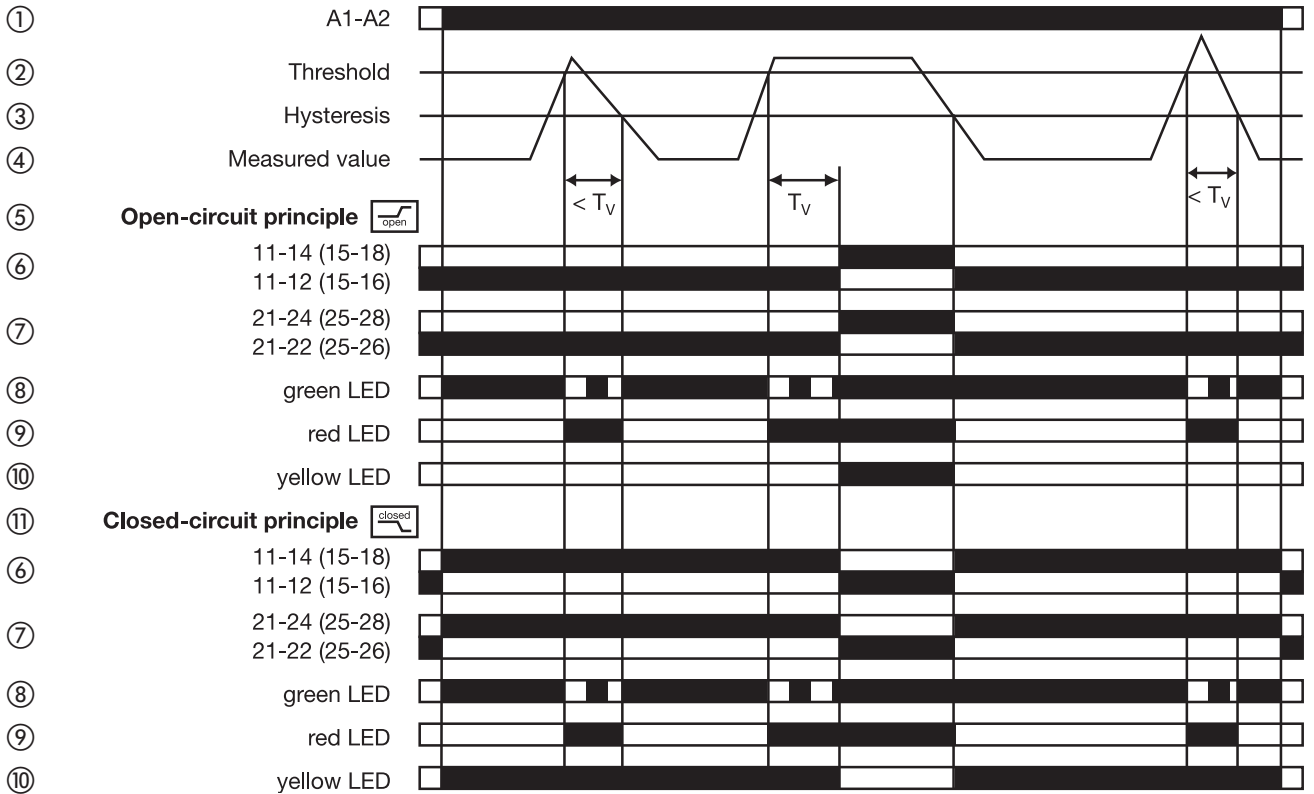

VI Undervoltage monitoring without latching

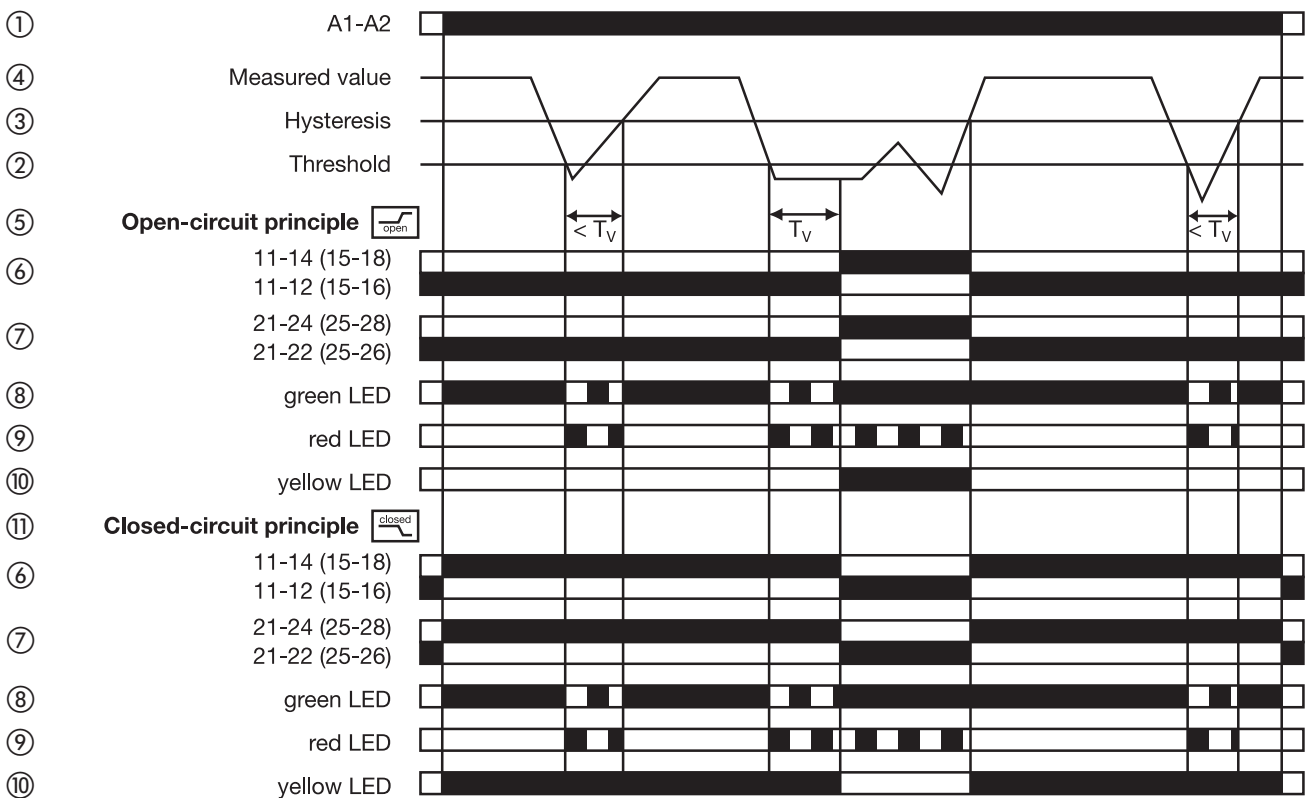



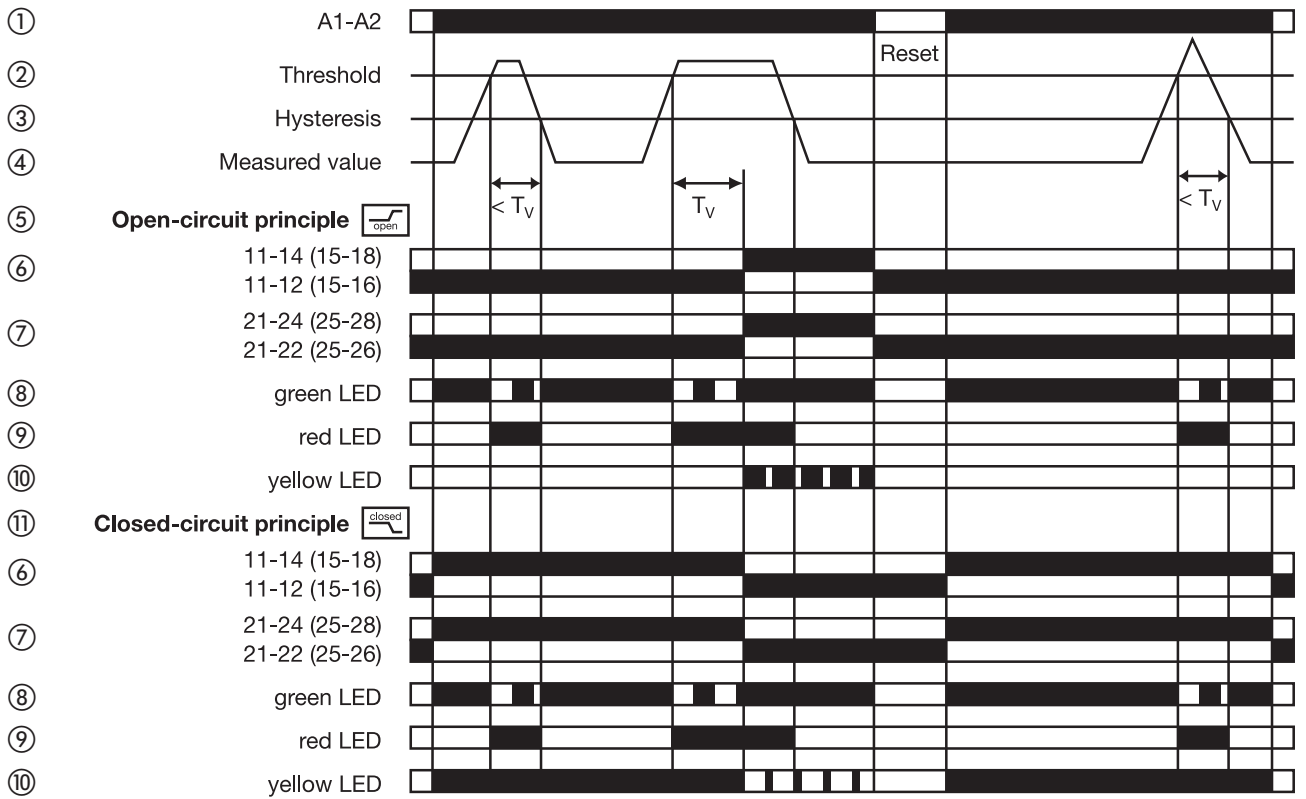

VII Overvoltage monitoring with latching

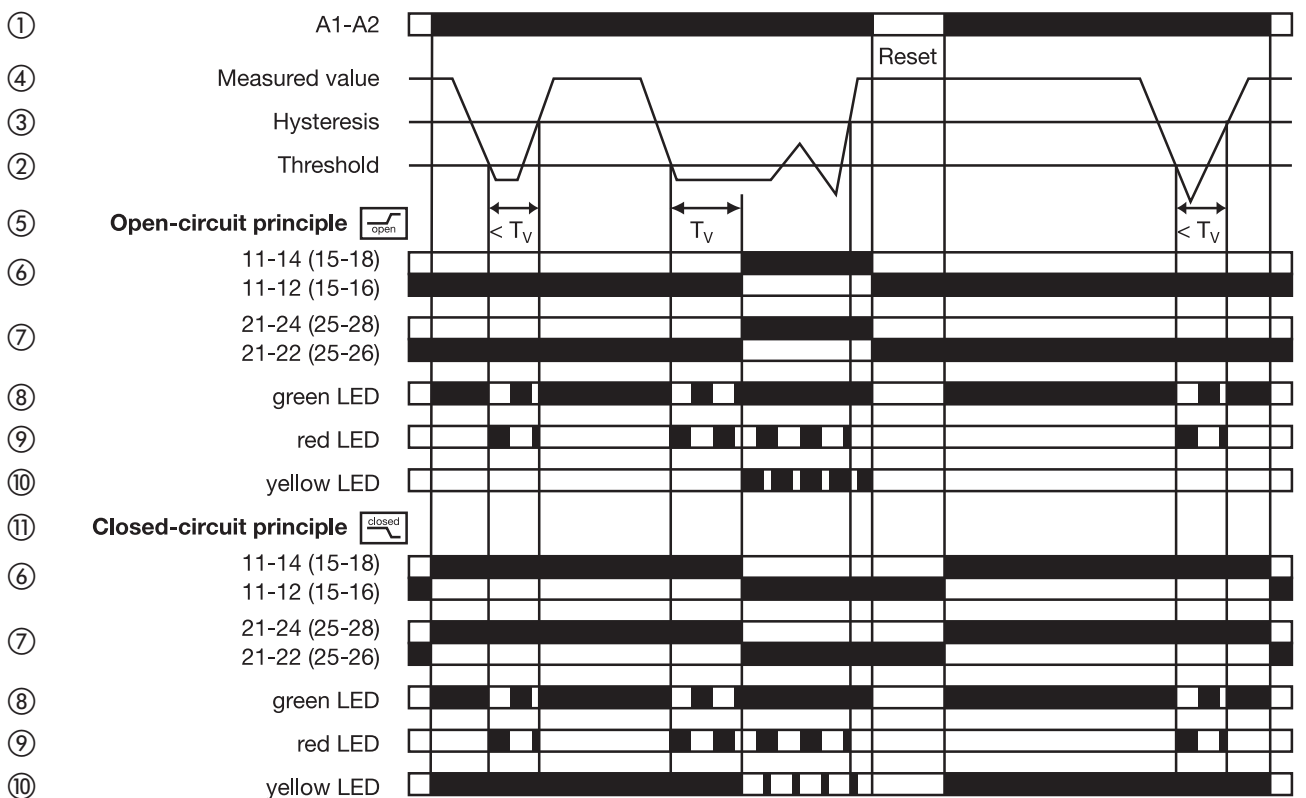









VIII Undervoltage monitoring with latching











Arbeitsweise



Die Spannungsüberwachungsrelais CM-ESS.M können in einphasigen AC- oder DC-Netzen je nach Konfiguration zur Über-  oder Unterspannungsüberwachung  eingesetzt werden. Die zu überwachende Spannung (Messwert) wird dazu an den Klemmen B-C eingespeist. Die Geräte arbeiten je nach Einstellung nach dem Arbeits-  oder Ruhestromprinzip .

Über- bzw. unterschreitet der Messwert den eingestellten Schwellwert wird die Auslöseverzögerung T_V gestartet. Befindet sich der Messwert nach Ablauf von T_V noch über bzw. unter dem Schwellwert minus bzw. plus der eingestellten Hysterese, ziehen die Ausgangsrelais an  / fallen die Ausgangsrelais ab .



Unter- bzw. überschreitet der Messwert den Schwellwert minus bzw. plus die eingestellte Hysterese, fallen die Ausgangsrelais ab  / ziehen die Ausgangsrelais an , sofern die Speicherung nicht aktiviert ist . Bei eingeschalteter Speicherung  bleiben die Ausgangsrelais angezogen  und fallen erst ab, wenn die Versorgungsspannung unterbrochen wird / bleiben die Ausgangsrelais abgefallen  und ziehen erst wieder an, wenn die Versorgungsspannung aus- und wieder eingeschaltet wird = Reset. Die Hysterese ist in einem Bereich von 3-30 % des Schwellwerts einstellbar.



Funktionsdiagramme



- V  Überspannungsüberwachung ohne Speicherung 
- VI  Unterspannungsüberwachung ohne Speicherung 
- VII  Überspannungsüberwachung mit Speicherung 
- VIII  Unterspannungsüberwachung mit Speicherung 







- ① Steuerspeisespannung
- ② Schwellwert
- ③ Hysterese
- ④ Messwert
- ⑤ Arbeitsstromprinzip 
- ⑥ Ausgangsrelais 1
- ⑦ Ausgangsrelais 2
- ⑧ LED grün
- ⑨ LED rot
- ⑩ LED gelb
- ⑪ Ruhestromprinzip 

Operating principle

Depending on the configuration, the voltage monitoring relays CM-ESS.M can be used for over-  or undervoltage monitoring  in single-phase AC or DC systems. The voltage to be monitored (measured value) is applied to terminals B-C.





Open  or closed-circuit principle  are selectable.



If the measured value exceeds or drops below the adjusted threshold value, the tripping delay T_V starts. If T_V is complete and the measured value is still exceeding or below the threshold value minus / plus the set hysteresis, the output relays energize  / de-energize .

If the measured value exceeds or drops below the threshold value plus / minus the set hysteresis and the latching function is not activated , the output relays de-energize  / energize . With activated latching function  the output relays remain energized  and de-energize only, when control supply voltage is interrupted / the output relays remain de-energized  and energize only, when control supply voltage is switched off and then again switched on = Reset.



The hysteresis is adjustable within a range of 3-30 % of the threshold value.

Function diagrams



- V Overvoltage monitoring without latching 
- VI Undervoltage monitoring without latching 
- VII Overvoltage monitoring with latching 
- VIII Undervoltage monitoring with latching 







- ① Control supply voltage
- ② Threshold value
- ③ Hysteresis
- ④ Measured value
- ⑤ Open-circuit principle 
- ⑥ Output relay 1
- ⑦ Output relay 2
- ⑧ green LED
- ⑨ red LED
- ⑩ yellow LED
- ⑪ Closed-circuit principle 

Principe de fonctionnement

Selon la configuration, les contrôleurs de tension CM-ESS.M peuvent être utilisés pour surveiller la sur-  ou sous-tension  dans des réseaux AC ou DC monophasés. La tension de mesure (valeur mesurée) est appliquée aux bornes B-C.





Les relais fonctionnent en logique positive  ou négative , selon le réglage.



Si la valeur mesurée dépasse ou chute en dessous de la valeur de seuil ajustée, la temporisation de déclenchement T_V commence. Les relais de sortie s'activent  / se désactivent , si, après la fin de T_V , la valeur mesurée se trouve encore en dessus ou en dessous de la valeur de seuil moins ou plus l'hystérésis ajustée.

Si la valeur mesurée dépasse ou chute en dessous de la valeur de seuil plus ou moins l'hystérésis ajustée, les relais de sortie se désactivent  / s'activent , pourvu que la mémorisation ne soit pas activée . Avec la mémorisation activée , les relais de sortie restent activés  et se désactivent seulement quand la tension d'alimentation de commande est coupée / les relais de sortie restent au repos  et s'activent seulement quand la tension d'alimentation de commande est coupée et puis branchée de nouveau = Remise à zéro.



L'hystérésis est ajustable dans une gamme de 3-30 % de la valeur du seuil.

Diagrammes de fonctionnement



- V Contrôle de surtension sans mémorisation 
- VI Contrôle de sous-tension sans mémorisation 
- VII Contrôle de surtension avec mémorisation 
- VIII Contrôle de sous-tension avec mémorisation 







- ① Tension d'alimentation de commande
- ② Valeur de seuil
- ③ Hystérésis
- ④ Valeur mesurée
- ⑤ Fonctionnement en logique positive 
- ⑥ Relais de sortie 1
- ⑦ Relais de sortie 2
- ⑧ LED verte
- ⑨ LED rouge
- ⑩ LED jaune
- ⑪ Fonctionnement en logique négative 

Funcionamiento





Dependiendo de la configuración, los relés de control de tensión CM-ESS.M pueden utilizarse para sobre-  o subtensión  en redes monofásicas de CA o de CC. La tensión de medida (valor medido) se aplica a los terminales B-C.



Principio de circuito abierto  o cerrado  seleccionable.

El retardo de disparo T_v empieza si el valor medido excede o cae por debajo del valor umbral. Si T_v se ha completado y el valor medido sigue por encima o por debajo del valor umbral ajustado, menos/más el valor ajustado de histéresis, los relés de salida se energizan  / des-energizan .



Si el valor medido excede o cae por debajo del valor umbral ajustado y la función de retención no está activada , los relés de salida se des-energizan  / energizan . Con la función de retención activada , los relés de salida se mantienen energizados  y se des-energizan sólo cuando se interrumpe la alimentación de mando/ los relés de salida se mantienen des-energizados  y se energizan sólo cuando se desconecta la tensión de alimentación de mando y se vuelve a conectar = Reset. La histéresis es ajustable en el rango de 3-30% del valor umbral.



Diagramas de funcionamiento



- V Control de sobretensión sin función de retención 
- VI Control de subtensión sin función de retención 
- VII Control de sobretensión con función de retención 
- VIII Control de subtensión con función de retención 







- ① Tensión de alimentación de mando
- ② Valor umbral
- ③ Hystéresis
- ④ Valor medido
- ⑤ Principio de circuito abierto 
- ⑥ Relé de salida 1
- ⑦ Relé de salida 2
- ⑧ LED verde
- ⑨ LED rojo
- ⑩ LED amarillo
- ⑪ Principio de circuito cerrado 

Funzionamento

A seconda della configurazione, i relè di controllo di tensione CM-ESS.M possono essere utilizzati per controllare sovra-  o sottotensione  in sistemi CA/CC monofasi.





La tensione da controllare (valore misurato) viene applicata ai morsetti B-C. Gli apparecchi lavorano secondo il principio di funzionamento normalmente aperto  o normalmente chiuso .



Se il valore misurato aumenta o diminuisce oltre il valore di soglia impostato, il ritardo di intervento T_v inizia. Se, dopo che è trascorso il tempo T_v , il valore misurato è ancora superiore o inferiore al valore di soglia meno o più l'isteresi impostata, i relè di uscita si eccitano  / diseccitano .

Se il valore misurato diminuisce o aumenta oltre il valore di soglia meno o più l'isteresi impostata, i relè di uscita si diseccitano  / eccitano , in quanto che la memorizzazione non sia attivata . Con la memorizzazione attivata , i relè di uscita rimangono eccitati  e si diseccitano solo se la tensione di comando viene interrotta / i relè di uscita rimangono diseccitati  e si eccitano solo se la tensione di comando viene disinserita e poi di nuovo inserita = Ripristino



L'isteresi è regolabile in un campo di 3-30 % del valore di soglia.



Diagrammi di funzionamento



- V Controllo di sovratensione senza memorizzazione 
- VI Controllo di sottotensione senza memorizzazione 
- VII Controllo di sovratensione con memorizzazione 
- VIII Controllo di sottotensione con memorizzazione 







- ① Tensione di comando
- ② Valore di soglia
- ③ Isteresi
- ④ Valore misurato
- ⑤ Funzionamento normalmente aperto 
- ⑥ Relè di uscita 1
- ⑦ Relè di uscita 2
- ⑧ LED verde
- ⑨ LED rosso
- ⑩ LED giallo
- ⑪ Funzionamento normalmente chiuso 

Принцип работы

В зависимости от конфигурации реле контроля напряжения CM-ESS.M может использоваться для контроля перенапряжения  или пониженного напряжения  в однофазных сетях постоянного или переменного тока.

Контролируемое напряжение (измеряемое значение) подается на клеммы В-С. Можно выбрать принцип разомкнутой  или замкнутой  цепи.

Если измеряемое значение превысит или соответственно упадет ниже заданного порогового значения, начнется отсчет времени задержки срабатывания реле T_v . Если отсчет времени T_v закончился, а измеряемое значение все еще превышает/остаётся ниже порогового значения за минусом/плюсом заданного гистерезиса, то выходные реле возбуждаются /обесточиваются .

Если измеряемое значение возвращается в заданные пределы, т.е. превышает минимальный порог/опускается ниже максимального порога на величину гистерезиса и функция памяти не включена , то выходные реле обесточиваются /возбуждаются . При включенной функции памяти  выходные реле остаются под напряжением  и обесточиваются только когда прерывается электропитание/ выходные реле остаются обесточенными  и возбуждаются только когда питающее напряжение отключается, а затем снова включается = Сброс.

Гистерезис регулируется в диапазоне 3-30 % порогового значения.



Функциональные схемы

V Контроль перенапряжения без запоминания 

VI Контроль пониженного напряжения без запоминания 



VII Контроль перенапряжения с запоминанием 



VIII Контроль пониженного напряжения с запоминанием 







- ① Питающее напряжение
- ② Пороговое значение
- ③ Гистерезис
- ④ Измеряемое значение
- ⑤ Принцип разомкнутой цепи 
- ⑥ Выходное реле 1
- ⑦ Выходное реле 2
- ⑧ Зеленый светодиод
- ⑨ Красный светодиод
- ⑩ Желтый светодиод
- ⑪ Принцип замкнутой цепи 

工作原理

根据设置，电压监视继电器CM-ESS.M可用于单相交流或直流系统的过电压监视或欠电压监视。被监视的电压（测量值）接到端子B-C。

开路或闭路原则可选。

若测量值超过或低于设定的阈值，动作延时 T_v 计时开始。若 T_v 计时结束且测量值仍大于或小于阈值减去/加上设定的磁滞，输出继电器动作/复位。

若测量值超过或低于设定的阈值加上/减去设定的磁滞，且故障保持功能未激活，输出继电器复位/动作。若故障保持功能激活：开路原则时，输出继电器动作，仅当控制供电电压中断时输出继电器才复位；闭路原则时，输出继电器复位，仅当控制供电电压中断后重新上电=reset时才动作。

磁滞可在阈值的3-30%范围内调节。

功能图

V 过电压监视，不带故障保持 

VI 欠电压监视，不带故障保持 

VII 过电压监视，带故障保持 

VIII 欠电压监视，带故障保持 

- ① 控制供电电压
- ② 阈值
- ③ 磁滞
- ④ 测量值
- ⑤ 开路原则 
- ⑥ 输出继电器1
- ⑦ 输出继电器2
- ⑧ 绿色 LED
- ⑨ 红色 LED
- ⑩ 黄色 LED
- ⑪ 闭路原则 