



Metal clad

Surface mounted wiring devices

Metal clad

Surface mounted wiring devices

The Metal clad range of surface mounted wiring devices is designed to be robust and resistant thanks to the high-quality coated metal plate. Capable of meeting wiring requirements in all commercial and light industrial applications. It is ideal for use in service areas, parking areas, workshops, factories, warehouses, laboratories, hospitals, and as well as domestic application in lofts and garages.

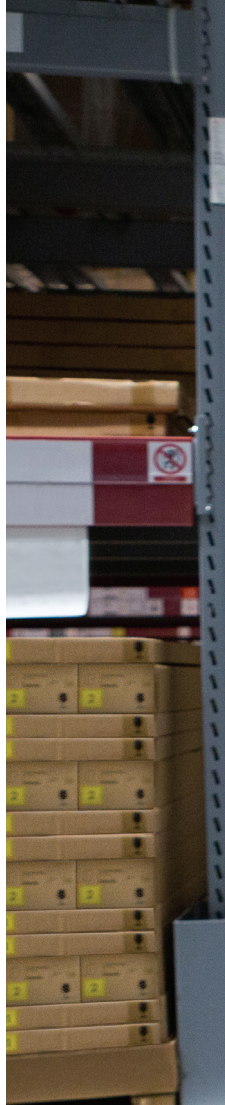

2 Gang 13A switched socket DP with Neon

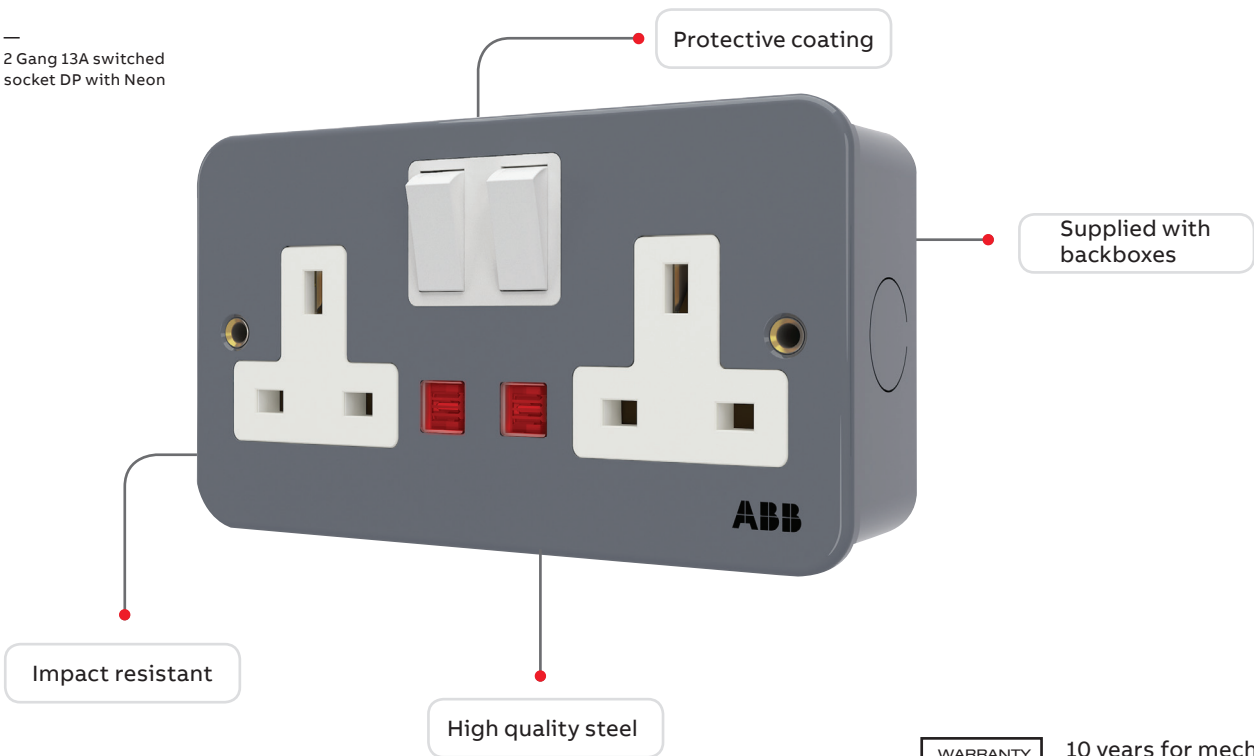

10 years for mechanical switches and socket outlets.



Benefits & features



- Manufactured from high quality steel with good aesthetics



- Designed to withstand everyday knocks and scrapes



- The durable and tough finish is further enhanced by a superb protective coating to stand up to arduous duty and environment



- Designed for easy mounting and installations

Product overview

Switches

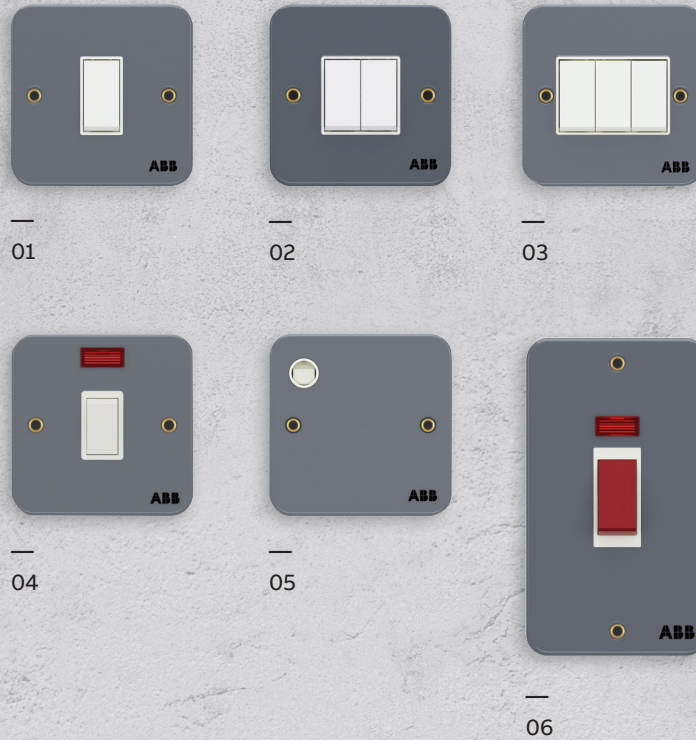

See product picture	Order Code	Type	Description	Technical Data	Surface-mounted Box Dimension
Switches					
01	2TCZ741004R0030	BM101	1Gang 1Way 10AX Switch	10AX	40mm
01	2TCZ741005R0030	BM105	1Gang 2Way 10AX Switch	10AX	40mm
01	2TCZ741010R0030	BM119	1Gang 10AX Intermediate Switch	10AX	40mm
01	2TCZ741011R0030	BM430	1Gang 1Way 10A Push Switch	10A	40mm
02	2TCZ741006R0030	BM102	2Gang 1Way 10AX Switch	10AX	40mm
02	2TCZ741007R0030	BM106	2Gang 2Way 10AX Switch	10AX	40mm
03	2TCZ741008R0030	BM103	3Gang 1Way 10AX Switch	10AX	40mm
03	2TCZ741009R0030	BM107	3Gang 2Way 10AX Switch	10AX	40mm
04	2TCZ741012R0070	BM171	1Gang 20A DP Switch with Neon	20A	40mm
05	2TCZ741014R0070	BM120	20A Connection unit with Flex outlet	20A	40mm
06	2TCZ741013R0090	BM177	1Gang 45A DP Switch with Neon (6 x 3)	45A	40mm

Note: all wiring devices are supplied with backboxes.

Socket & Data outlets FCU & Flex outlets/Accessories

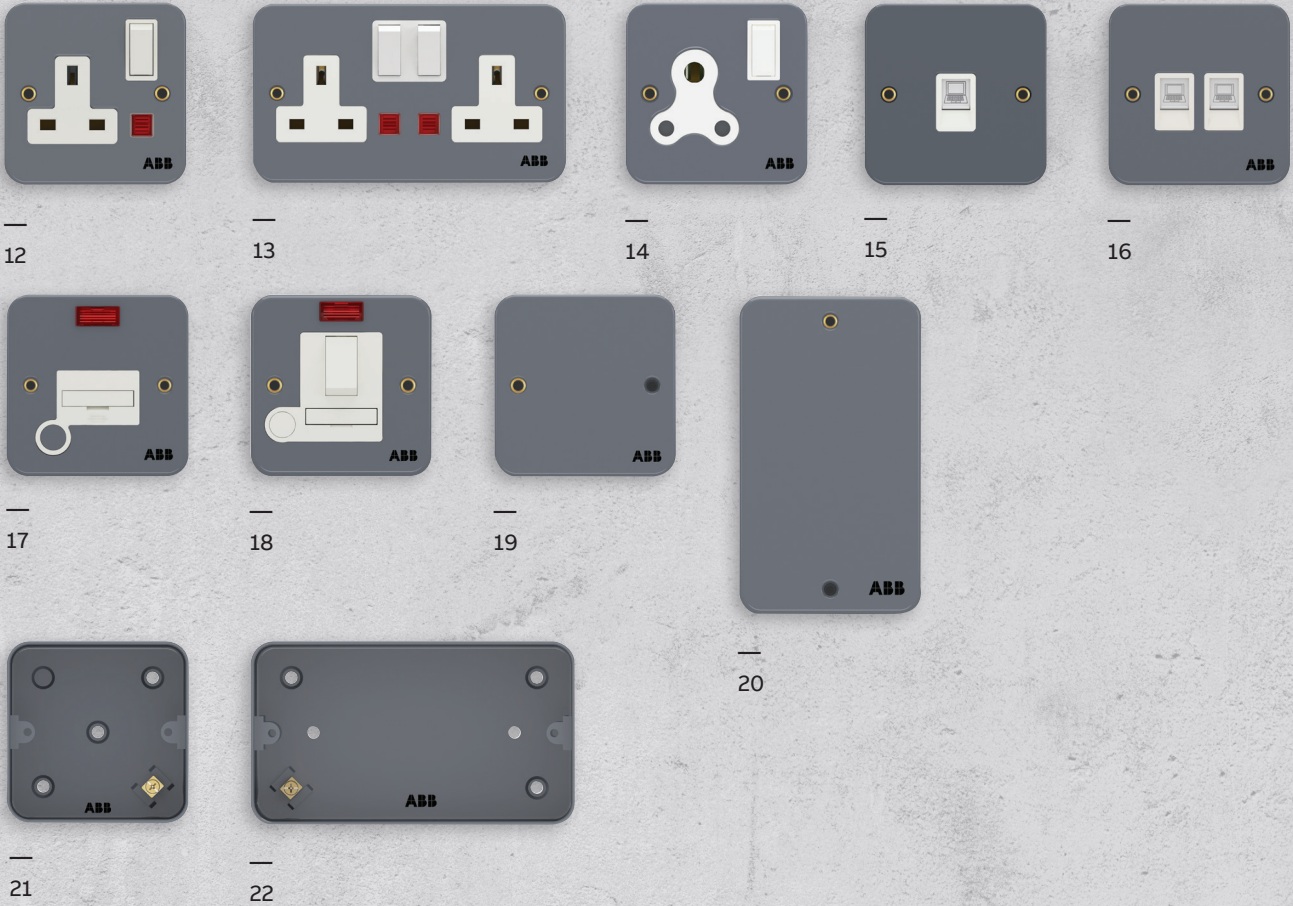

See product picture	Order Code	Type	Description	Technical Data	Surface-mounted Box Dimension
Socket & Data outlets/FCU & Flex outlet/Accessories					
12	2TCZ742001R0040	BM238	1Gang 13A Switched Socket DP with Neon	13A	40mm
13	2TCZ742002R0040	BM240	2Gang 13A Switched Socket DP with Neon	13A	40mm
14	2TCZ742003R0050	BM209	1Gang 15A Switched Socket SP	15A	40mm
15	2TCZ743001R0010	BM333	1Gang Data outlet, Cat.6	RJ45	40mm
16	2TCZ743002R0010	BM329	2Gang Data outlet, Cat.6	RJ45	40mm
17	2TCZ745001R0040	BM577	1Gang 13A Unswitched fused connection unit with Neon	13A	40mm
18	2TCZ745002R0040	BM507	1Gang 13A Switched fused connection unit with Neon	13A	40mm
19	2TCZ745003R0010	BM504	1Gang Blank plate	-	-
20	2TCZ745004R0010	BM505	2Gang Blank plate	-	-
21	2TCZ745005R0010	BM541	1Gang Metal mounting box	-	40mm
22	2TCZ745006R0010	BM542	2Gang Metal mounting box	-	40mm

Note: all wiring devices are supplied with backboxes.

Product Technical Information

International standards

Product description	Standard	Description
Switches	IEC 60669-1/BSEN60669-1	Switches for household and similar fixed electrical installation
13A sockets	BS1363-2,SS145-2,SASO2203	13A switched and unswitched socket outlets
15A sockets	BS 546, SS472	Two-pole and earthing-pin plugs, socket outlets and socket -outlet adaptors
Fused Connection units	BS 1363-4, SS403	Specification for 13A fused connection units switched and unswitched
Flex outlet 20A	BS5733	General requirements for electrical accessories
Computer outlet RJ45	BS5733	Commercial building telecommunications cabling standard Part 2: Balanced twisted pair cabling components
Plates	BS5733	Specification for general requirements for electrical accessories
Mounting box	BS5733	Specification for general requirements for electrical accessories

Product Technical Information

Dimensions

Dimensions for 1 gang frames

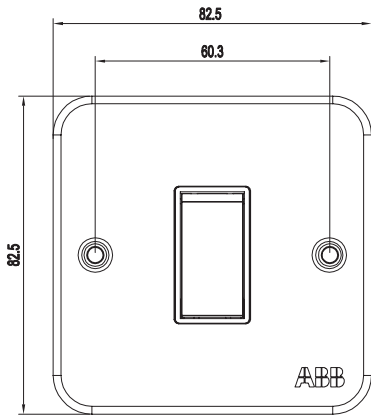

Dimensions for 2 gang frames

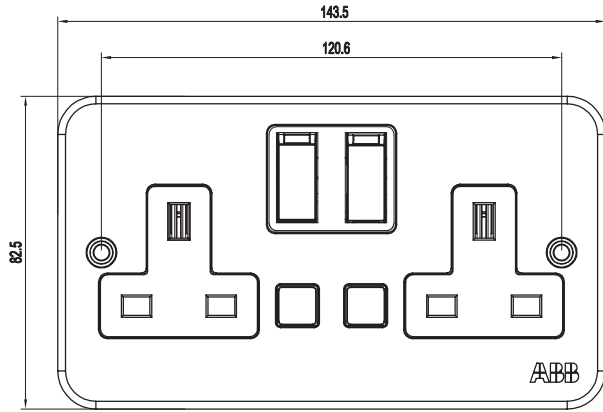

Dimensions for 1 gang mounting box

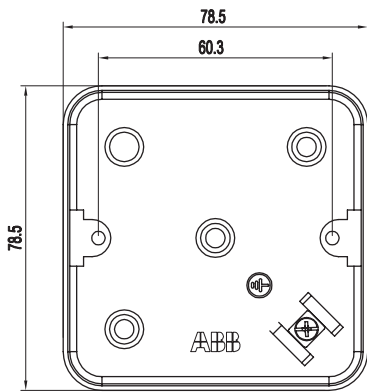

Dimensions for 2 gang mounting box

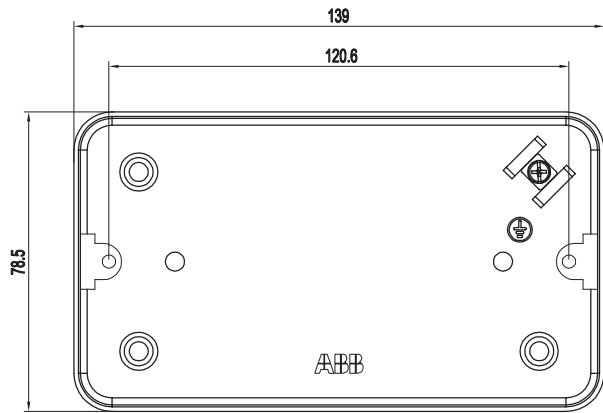

Dimensions for 1 gang 45A double pole switch

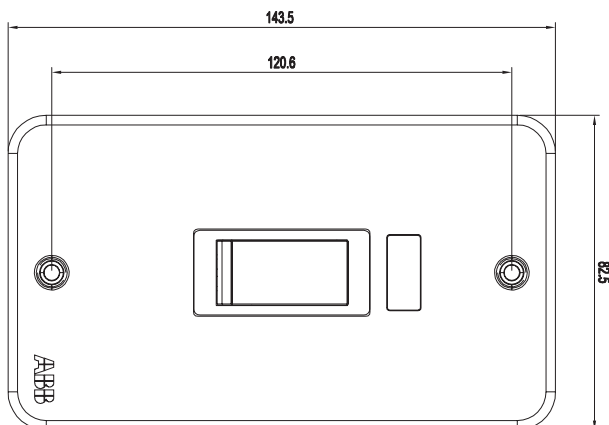

Product Technical Information

Wiring Diagrams

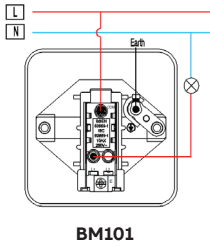

BM101

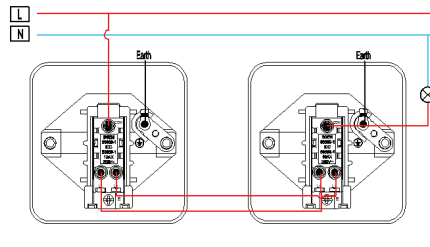

BM105

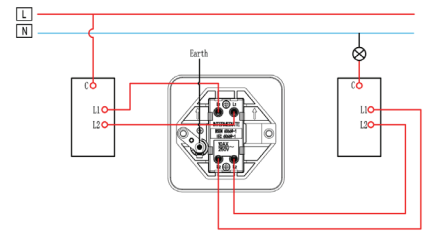

BM119

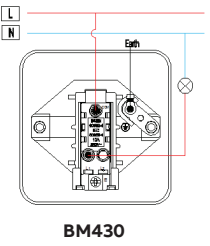

BM430

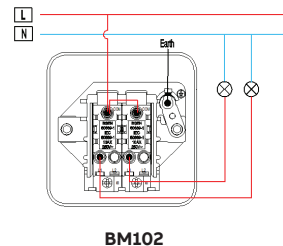

BM102

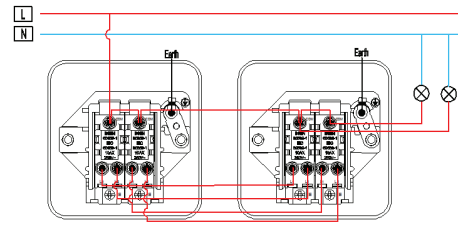

BM106

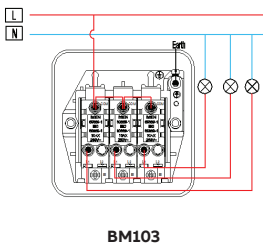

BM103

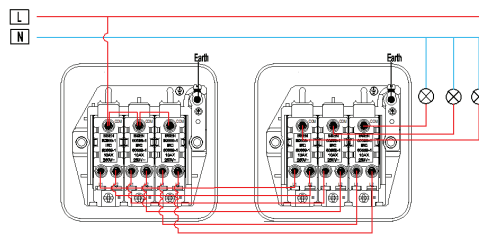

BM107

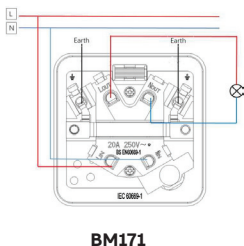

BM171

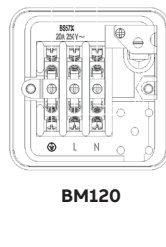

BM120

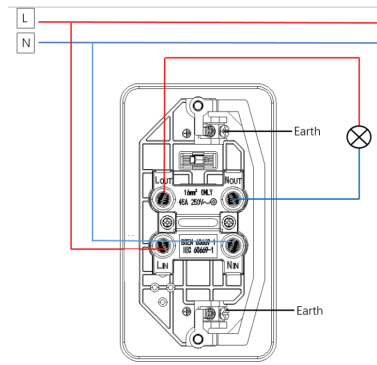

BM177

Product Technical Information

Wiring Diagrams

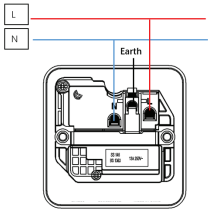

BM238

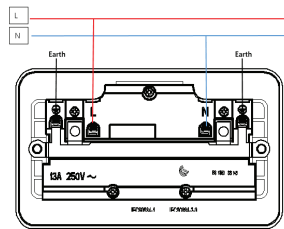

BM240

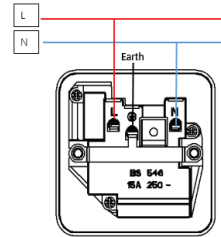

BM209

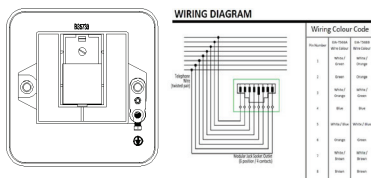

BM333

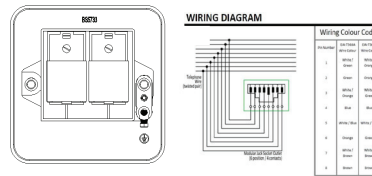

BM329

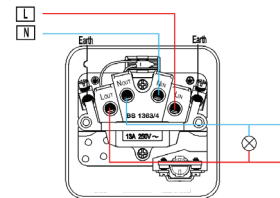

BM577

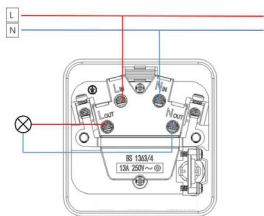

BM507

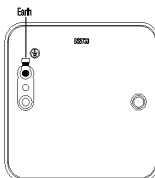

BM504

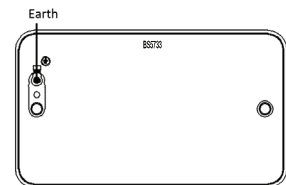

BM505

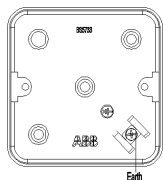

BM541

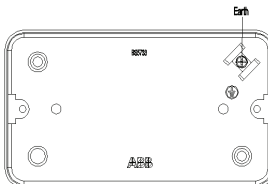

BM542

Contacts

UAE

ABB Industries LLC

Al Quoz Industrial Area 3
4th Interchange, St. No: 4 Dubai
Phone: 0097 1 (4) 3147500
info@ae.abb.com

Saudi Arabia

ABB Electrical Industries Co. Ltd.

Al Ahsa Street, Malaz 11371, Riyadh
Phone: 00966 11 4845600

Qatar

ABB LLC

Al Asmakh Tower, 15th floor
864 Hazm Zraig St., Bldg No. 49
Zone 63, Onaiza District,
West Bay
PO BOX 8688
Phone: +974 4425 3888

Kuwait

ABB Engineering Technologies Co. (KSCC)

Alghunaim Commercial Twr, 2nd Flr,
Al-Qibla Area
P.O.Box 4275, Safat-13043,
Abu Baker Al-Sadique Street
Phone: +965 2428626

Bahrain

ABB Technologies W.L.L.

Gulf Executive Offices,
12/Flr. Office 1023
Entrance 15, Road 3801,
AlGudaibiya 338
P.O. Box 2774, Manama
Phone: +973 17810659

Oman

ABB LLC

218, Hatat House, P. O. Box 778,
131 Al Hamriya Muscat
Phone: 00968 24 567 410

Jordan

ABB Ltd.

Wasfi Altal Street - Building 356 - Khalda
P.O Box 926098 Amman 11190
Phone: +962 (6) 5507733

Pakistan

ABB (Pakistan) Ltd.

P.E.C. Building, 97 A/D 1.
Liberty Market, Gulberg III
P.O. 2353 Lahore, 54660
Phone: +92 42 32560740

Nigeria

ABBNG LTD

Plot 8C Metalbox road,
off Acme road Ogba, Ikeja, Lagos
Mobile: +234 70 16824614
Email: ahmed.gamal@ng.abb.com

Sri Lanka

Asea Brown Boveri Lanka(Pvt) Limited

Level 18, West Tower, World Trade
Center
Colombo 00100,
Phone : +94 77 7896445
Email: ranjan.weemanna@lk.abb.com

Bangladesh

ABB Limited
The Glass House
38 Gulshan Avenue (12th Floor)
Dhaka 1212
Phone: +88 02 98 56468 / 53412

Singapore

ABB Pte. Ltd.

2, Ayer Rajah Crescent
SGP - 139935
Phone: +65 6 776 5711

Malaysia

ABB Malaysia Sdn Bhd

Block A, Level 2, Lot 608, Jalan SS13/1K
47500 Subang Jaya
MY Selangor Darul Ehsan
Phone: +603 5628 4888

Vietnam

ABB Automation and Electrification (Vietnam) Company Ltd

12th Floor, Ree Tower,
9 Doan Van Bo Street
12th ward, 4 District, Ho Chi Minh City
Phone: +8428 3943 1488

Indonesia

PT. ABB Sakti Industri

26th Floor, World Trade Center 3
Ji Jend Sudirman Kav 29-31
Jakarta 12920
Phone: +62 21 2559 5599

Hong Kong China

ABB (Hong Kong) Limited

Units E & F S/F.,
YHC Tower, Nr. 1 Sehung, Yuet Road
Kowloon Bay, Kowloon
Phone: +852 2929-3912



—
abb.com/lowvoltage