

AF38-40-00-.. / AF38Z-40-00-.. 4-pole Contactors AC / DC Operated - with Screw Terminals

AF38(Z) contactors are used for controlling power circuits up to 690 V AC and 440 V DC. They are mainly used for controlling non-inductive or slightly inductive loads (i.e. resistance furnaces...).

- AF..(Z) contactors include an electronic coil interface providing reduced pull-in and holding consumption, particularly for AC control circuits
- Only four coils are needed to cover control voltages between 24...500 V 50/60 Hz or 20...500 V DC.
- AF..(Z) offer extended operating limits and are suitable worldwide for different control voltages. e.g.: the coil 100...250 V 50/60 Hz - DC is suitable for Europe (230 V 50 Hz) and for North America (120 V 60 Hz and 208 V 60 Hz).
- AF..(Z) contactors can manage large control voltage variations.
- AF.Z contactors equipped with a 24...60 V 50/60 Hz - 20...60 V DC coil allow direct control by 24 V DC 500 mA PLC-output
- AF.Z contactors withstand short voltage dips and voltage sags (SEMI F47-0706 compliance)
- AF..(Z) contactors have built-in surge protection and do not require additional surge suppressors.



		55 A	
--	--	------	--

3D CAD outline drawings available on «Control Product 3D» portal

Ordering Details

IEC	UL/CSA	Control voltage	Auxiliary contacts	Type	Order code	EAN	Weight
AC-1 Rated current	General use rating	Uc min. ... Uc max.	fitted				
$\theta \leq 40^\circ\text{C}$ A	600 V AC A	V 50/60 Hz V DC					Pack ^(ing) 1 piece kg

4-pole Contactors 4 N.O. Main Poles

IEC	UL/CSA	Control voltage	Auxiliary contacts	Type	Order code	EAN	Weight
55	55	24...60	0 0	AF38-40-00-11	1SBL 297 201 R1100	3471523115316	0.360
		48...130	0 0	AF38-40-00-12	1SBL 297 201 R1200	3471523115323	0.360
		100...250	0 0	AF38-40-00-13	1SBL 297 201 R1300	3471523115330	0.360
		250...500	0 0	AF38-40-00-14	1SBL 297 201 R1400	3471523115347	0.400

Note: AF38-40-00-11 not suitable for a direct control by PLC-output. AF38-40-00-11 available in some countries: please consult your ABB representative.

4-pole Contactors 4 N.O. Main Poles - Low Consumption

IEC	UL/CSA	Control voltage	Auxiliary contacts	Type	Order code	EAN	Weight
55	55	-	0 0	AF38Z-40-00-20	1SBL 296 201 R2000	3471523116108	0.400
		24...60	0 0	AF38Z-40-00-21	1SBL 296 201 R2100	3471523116115	0.400
		48...130	0 0	AF38Z-40-00-22	1SBL 296 201 R2200	3471523116122	0.400
		100...250	0 0	AF38Z-40-00-23	1SBL 296 201 R2300	3471523116139	0.400

Note: Only AF..Z contactors with DC control voltage 12...20 V DC need to respect the connection polarities indicated close to the coil terminals: A1+ for the positive pole and A2- for the negative pole

Certifications and Approvals

--	--	--	--	--	--	--	--	--	--

Main Pole - Utilization Characteristics according to IEC

Standards	IEC 60947-1 / 60947-4-1 and EN 60947-1 / 60947-4-1	
Rated operational voltage U_e max.	690 V	
Rated frequency limits	25 ... 400 Hz	
Conventional free-air thermal current I_{th} acc. to IEC 60947-4-1, open contactors, $\theta \leq 40\text{ °C}$	55 A	
with conductor cross-sectional area	16 mm ²	
AC-1 Utilization category for air temperature close to contactor		
I_e / AC-1 rated operational current	$\theta \leq 40\text{ °C}$	55 A
U_e max. $\leq 690\text{ V}$, 50/60 Hz	$\theta \leq 60\text{ °C}$	45 A
	$\theta \leq 70\text{ °C}$	37 A
with conductor cross-sectional area	16 mm ²	
Short-circuit protection for contactors without thermal O/L relay - Motor protection excluded U _e $\leq 500\text{ V AC}$ - gG type fuse	63 A	
Rated short-time withstand current I_{cw}	1 s	450 A
at 40 °C ambient temperature, in free air from a cold state	10 s	300 A
	30 s	225 A
	1 min	150 A
	15 min	55 A
Heat dissipation per pole	I_e / AC-1	2.3 W
Max. electrical switching frequency	AC-1	600 cycles/h

Main Pole - Utilization Characteristics according to UL / CSA

Standards	UL 508, CSA C22.2 N°14	
Rated operational voltage U_e max.	600 V	
UL General use rating		
600 V AC	55 A	
With conductor cross-sectional area	AWG 6	
80 V DC - 1-pole for 4 N.O. main poles	55 A	
With conductor cross-sectional area	AWG 6	
80 V DC - 1-pole for 2 N.O. / 2 N.C. main poles		
With conductor cross-sectional area		
Max. electrical switching frequency for general use	600 cycles/h	

General Technical Data

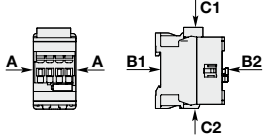
Rated insulation voltage U_i	690 V	
acc. to IEC 60947-4-1	600 V	
acc. to UL	6 kV	
Rated impulse withstand voltage U_{imp}	6 kV	
Electromagnetic compatibility	Devices complying with IEC 60947-1 / EN 60947-1 - Environment A	
Ambient air temperature close to contactor		
Operation in free air	-40 ... +70 °C	
Storage	-60 ... +80 °C	
Climatic withstand	Category B according to IEC 60947-1 Annex Q	
Operating altitude	≤ 3000 m	
Mechanical durability		
Number of operating cycles	10 millions operating cycles	
Max. switching frequency	3600 cycles/h	
Shock withstand acc. IEC 60068-2-27 and EN 60068-2-27		
Mounting position 1		
	Shock direction	1/2 sinusoidal shock for 11 ms: no change in contact position
	A	30 g
	B1	25 g Closed position / 5 g Open position
	B2	15 g
	C1	25 g
C2	25 g	
Vibration withstand	5 ... 300 Hz	
acc. to IEC 60068-2-6	4 g Closed position / 2 g Open position	

Magnet System Characteristics

Coil operating limits	AC supply	at $\theta \leq 60$ °C 0.85 x U_c min ... 1.1 x U_c max
acc. to IEC 60947-4-1		at $\theta \leq 70$ °C 0.85 x U_c min ... U_c max
	DC supply	at $\theta \leq 60$ °C 0.85 x U_c min ... 1.1 x U_c max
		at $\theta \leq 70$ °C (AF) 0.85 x U_c min ... U_c max - (AF..Z) 0.85 x U_c min ... 1.1 x U_c max
AC control voltage	Rated control circuit voltage U_c	24 ... 500 V AC
50/60 Hz	Coil consumption	Average pull-in value (AF) 50 VA - (AF..Z) 16 VA
		Average holding value (AF) 2.2 VA / 2 W - (AF..Z) 1.7 VA / 1.5 W
DC control voltage	Rated control circuit voltage U_c	12 ... 500 V DC
	Coil consumption	Average pull-in value (AF) 50 W - (AF..Z) 12 ... 16 W
		Average holding value (AF) 2 W - (AF..Z) 1.7 W
PLC-Output control		(AF..Z) ≥ 500 mA 24 V DC
Drop-out voltage in % of U_c min.		≤ 60 % U_c min
Voltage sag immunity according to SEMI F47-0706		(AF..Z) conditions of use on request
Dips withstand (level 0% according to IEC 61000-4-11)		(AF..Z) 22 ms average for $U_c = 24$... 250 V 50/60Hz
-20 °C ≤ θ ≤ +60 °C		
Operating time	between coil energization and:	N.O. contact closing 40 ... 95 ms
		N.C. contact opening 38 ... 90 ms
	between coil de-energization	N.O. contact opening 11 ... 95 ms
	and:	N.C. contact closing 13 ... 98 ms

Mounting Characteristics

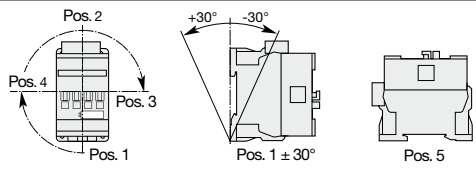
Mounting positions	
	Max. add-on N.C. auxiliary contacts: see accessory fitting details for a 4-pole contactor AF09 ... AF38
Mounting distances	The contactors can be assembled side by side.
Fixing	
on rail according to IEC 60715, EN 60715	35 x 7.5 mm or 35 x 15 mm
by screws (not supplied)	2 x M4 screws placed diagonally





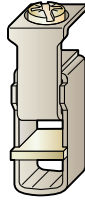









Connecting Characteristics

Main terminals



Screw terminals with double connector
2 x (5.5 width x 6.8 depth)

Connecting capacity (min. ... max.)

Main conductors (poles)		
 Rigid	solid ($\leq 4 \text{ mm}^2$)	1 x : 1.5 ... 16 mm ²
 Rigid	stranded ($\geq 6 \text{ mm}^2$)	2 x : 1.5 ... 16 mm ²
 Flexible with non insulated ferrule		1 x : 1.5 ... 16 mm ²
 Flexible with non insulated ferrule		2 x : 1.5 ... 16 mm ²
 Flexible with insulated ferrule		1 x : 1.5 ... 16 mm ²
 Flexible with insulated ferrule		2 x : 1.5 ... 16 mm ²
 Bars or lugs		L < -
Capacity according to UL/CSA		1 or 2 x : AWG 16 ... 6
Stripping length		12 mm
Auxiliary conductors		
 Rigid solid		1 x : 1 ... 2.5 mm ²
 Rigid solid		2 x : 1 ... 2.5 mm ²
 Flexible with non insulated ferrule		1 x : 0.75 ... 2.5 mm ²
 Flexible with non insulated ferrule		2 x : 0.75 ... 2.5 mm ²
 Flexible with insulated ferrule		1 x : 0.75 ... 2.5 mm ²
 Flexible with insulated ferrule		2 x : 0.75 ... 1.5 mm ²
 Bars or lugs		L < 8 mm
Capacity according to UL/CSA		1 or 2 x : AWG 18 ... 14
Stripping length		10 mm
Degree of protection		
acc. to IEC 60947-1 / EN 60947-1 and IEC 60529 / EN 60529		
Main terminals		IP20
Coil terminals		IP20
Screw terminals		(delivered in open position, screws of unused terminals must be tightened)
Main terminals		M4.5
Coil terminals		M3.5
Screwdriver type		Flat Ø 5.5 / Pozidriv 2
Tightening torque		
Main pole terminals		2.5 Nm / 22 lb.in
Coil terminals		1.2 Nm / 11 lb.in

Accessory Fitting Details for a 4-pole Contactor

Many configurations of accessories are possible depending on whether these are front-mounted or side-mounted.

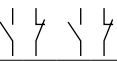
Main poles	Built-in auxiliary contacts	Front-mounted accessories			Electrical and mechanical interlock set (between 2 contactors)	Side-mounted accessories	
		Auxiliary contact blocks				Auxiliary contact blocks	
		1-pole CA4			VEM4	Left side	Right side
		1-pole CC4	2-pole CAT4-11	4-pole CA4		2-pole CAL4-11	
Max. add-on N.C. auxiliary contacts: 3 N.C. max. on positions 1, 2, 3, 4 and 2 N.C. max. on positions 1 ±30°, 5							
4 0 0 0	4 max.	or 1	or 1	-	-	+ 1	-
	2 max.	or 1	-	-	-	+ 1	+ 1
	3 max.	-	-	-	+ 1	+ 1	or 1

Overview of main accessories (other accessories available)

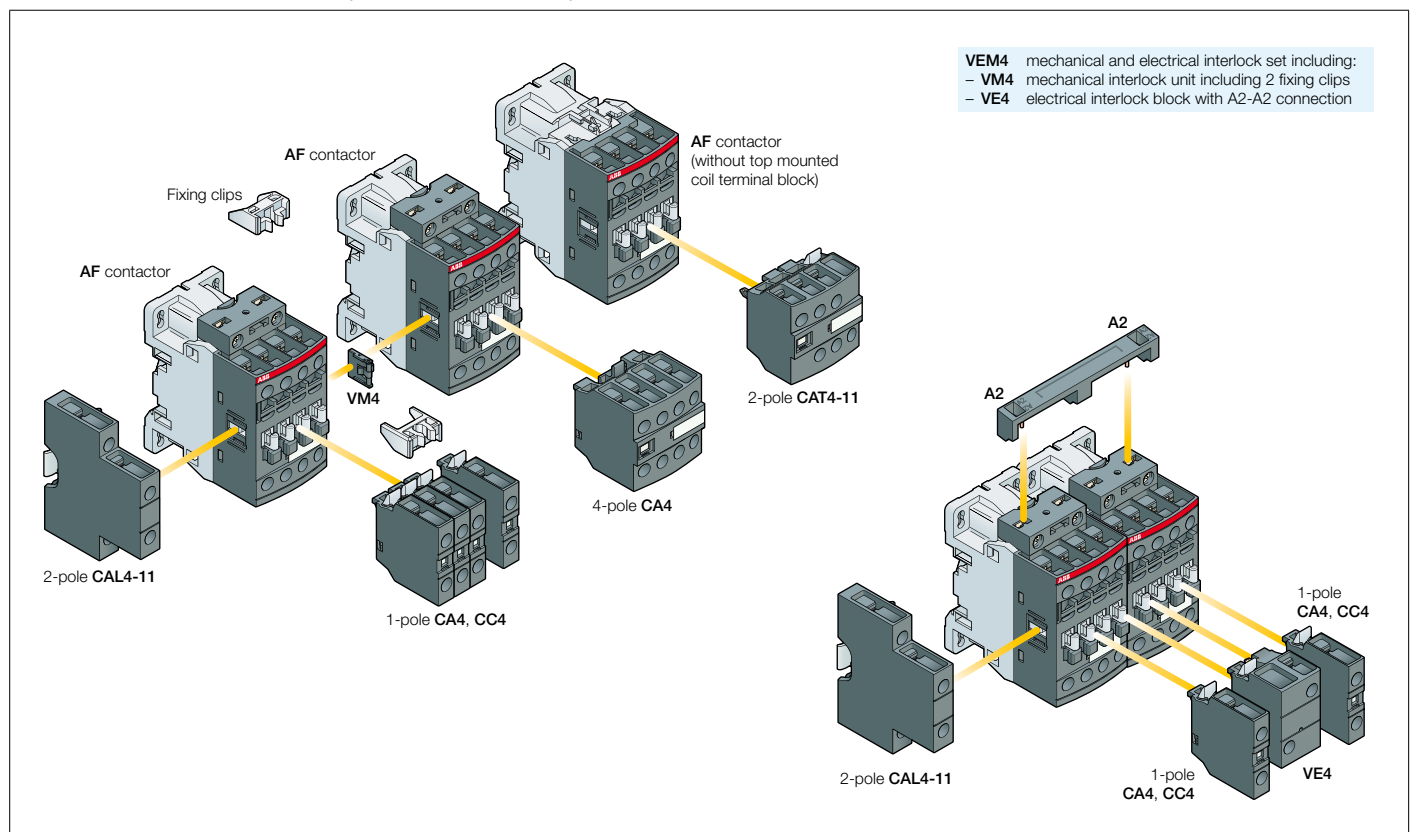

Main Accessories

Ordering Details

Description	Auxiliary contacts 	Type	Order code	EAN	Pack ^(ing) piece	Weight	
						kg (1 pce)	
Additional auxiliary contact blocks	Front-mounted instantaneous auxiliary contact blocks	0 1 - -	CA4-01	1SBN 010 110 R1001	3471523130029	1	0.014
		1 0 - -	CA4-10	1SBN 010 110 R1010	3471523130005	1	0.014
		0 1 - -	CA4-01-T	1SBN 010 110 T1001	3471523130395	10	0.014
		1 0 - -	CA4-10-T	1SBN 010 110 T1010	3471523130371	10	0.014
	Front-mounted auxiliary contact blocks with N.O. leading contact and N.C. lagging contact	- - 0 1	CC4-01	1SBN 010 111 R1001	3471523130432	1	0.014
		- - 1 0	CC4-10	1SBN 010 111 R1010	3471523130425	1	0.014
	Side-mounted instantaneous auxiliary contact blocks	1 1 - -	CAL4-11	1SBN 010 120 R1011	3471523130043	1	0.040
		1 1 - -	CAL4-11-T	1SBN 010 120 T1011	3471523130418	10	0.040
	Front-mounted instantaneous auxiliary contact blocks	0 4 - -	CA4-04E	1SBN 010 140 R1004	3471523130159	1	0.055
		2 2 - -	CA4-22E	1SBN 010 140 R1022	3471523130128	1	0.055
		3 1 - -	CA4-31E	1SBN 010 140 R1031	3471523130135	1	0.055
		4 0 - -	CA4-40E	1SBN 010 140 R1040	3471523130142	1	0.055
	1 1 - -	CAT4-11E	1SBN 010 151 R1011	3471523130067	1	0.040	
Interlocks	Mechanical interlock unit		VM4	1SBN 030 105 T1000	3471523130609	10	0.005
	Mechanical and electrical interlock set	1 1 - -	VEM4	1SBN 030 111 R1000	3471523130616	1	0.035
	Fixing clips		BB4	1SBN 110 120 W1000	3471523130722	50	0.002
Additional coil terminal block	Additional coil terminal block		LDC4	1SBN 070 156 T1000	3471523130678	10	0.010
Protective covers	Protective covers		BX4	1SBN 110 108 T1000	3471523130708	10	0.006
			BX4-CA	1SBN 110 109 W1000	3471523130715	50	0.001
Function markers	Function markers		BA4	1SNA 235 156 R2700	3472592351568	16	0.011
			HTP500-BA4	1SNA 235 712 R2400	3472592357126	1	0.220
			SPRC 1	1SNA 360 010 R1500	3472593600108	1	0.290

Note:

- CAT4: not fittable on AF..Z contactors with DC control voltage 12...20VDC.
- VM4: includes 2 fixing clips (BB4) to maintain together both contactors.
- VEM4: includes a VM4 mechanical interlock unit with 2 fixing clips (BB4), a VE4 electrical interlock block and A2-A2 connection. VE4 block must be used with its A2-A2 connection to respect the electrical connection diagram.
- VEM4 not fittable on AF..Z contactors with DC control voltage 12...20 V DC.

Terminal Marking and Positioning

Standard devices without addition of auxiliary contacts

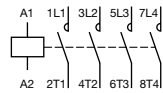
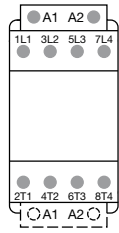

AF38-40-00-.. / AF38Z-40-00-..

AF38-40-00-.. / AF38Z-40-00-..

Dimensions mm, inches

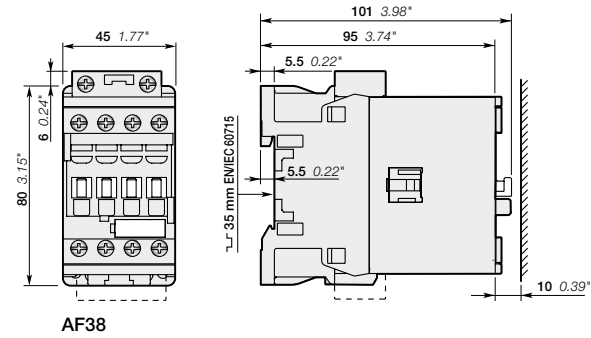

AF38

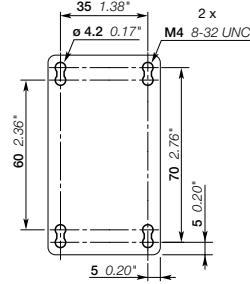

AF38

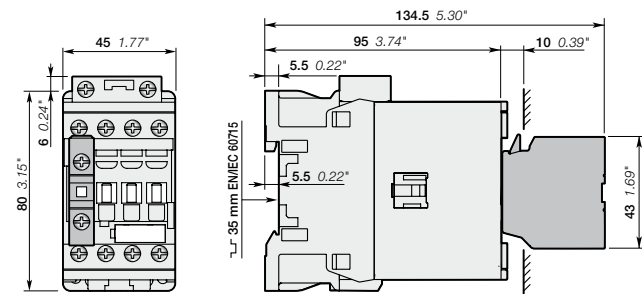

AF38
+ CA4, CC4 1-pole auxiliary contact block

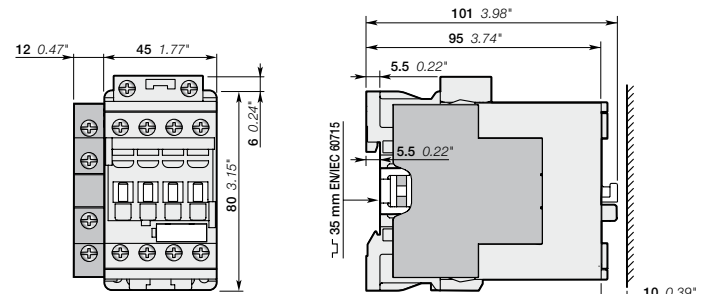

AF38
+ CAL4-11 2-pole auxiliary contact block

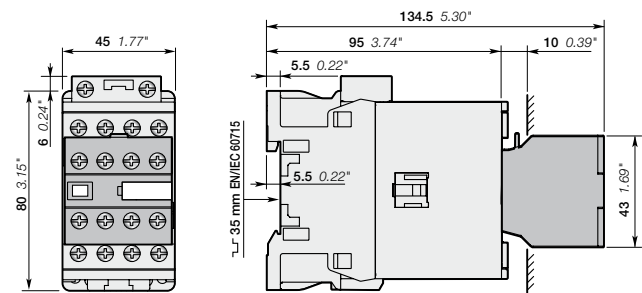

AF38
+ CA4 4-pole auxiliary contact block

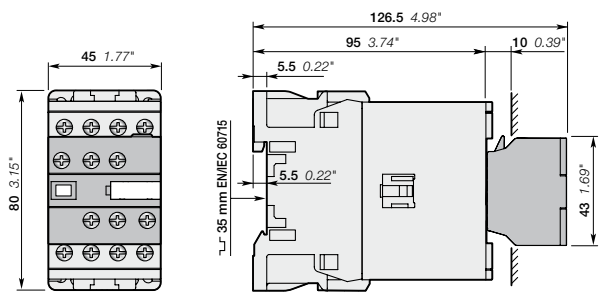

AF38
+ CAT4 2-pole auxiliary contact and coil terminal block

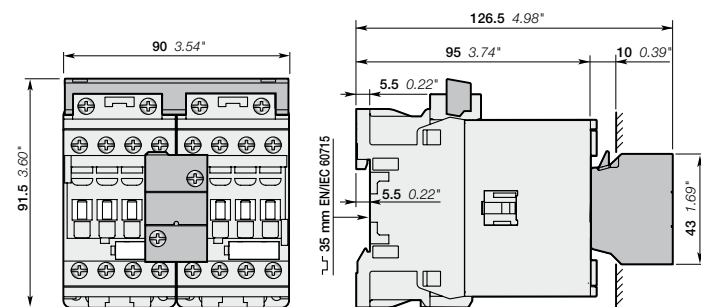

AF38
+ VEM4 mechanical and electrical interlock set

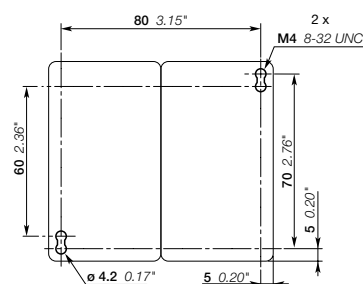

AF38
+ VEM4 mechanical and electrical interlock set

Note: contactor lateral distance to grounded component 2 mm 0.08" min.

Contact us

ABB France

Low Voltage Products Division

10, rue Ampère Z.I. - B.P. 114

F-69685 Chassieu cedex / France

You can find the address of your local sales organisation
on the ABB home page

<http://www.abb.com/contacts> -> Low Voltage products

Note

We reserve the right to make technical changes or modify the contents of this document without prior notice. With regard to purchase orders, the agreed particulars shall prevail. ABB does not accept any responsibility whatsoever for potential errors or possible lack of information in this document.

We reserve all rights in this document and in the subject matter and illustrations contained therein. Any reproduction, disclosure to third parties or utilization of its contents – in whole or in parts – is forbidden without prior written consent of ABB.

Copyright© 2011 ABB
All rights reserved