

Easy and Intuitive Method for Testing Transformer Differential Relays

Zoran Gajić
Vasteras, Sweden

Fahrudin Mekic
Allentown, PA

**Presented to:
62nd Annual Georgia Tech Protective Relaying Conference
May 21-23, 2008**

Abstract

Differential protection for standard power transformers has been used for decades. It is based on ampere-turn-balance of all windings mounted on the same magnetic core lag. In order to correctly apply transformer differential protection the following compensations shall be provided:

- current magnitude compensation for measured current magnitude difference on different sides of the protected transformer;
- power transformer phase angle shift compensation; and
- zero sequence current compensation (i.e. zero sequence current elimination).

With modern numerical transformer differential relays all above compensations are provided in the relay software. Thus, it can be quite tricky to test a numerical transformer differential relay by secondary injection in order to verify that the relay is set properly to protect transformer in a particular application. This paper will address these topics as well as provide standardized solutions for secondary injection testing for transformer differential protection relay from any manufacturer.

1. Introduction

In order to understand the presented testing methods some basic information about power system will be reviewed.

1.1 Symmetrical Components Theory

The method of Symmetrical Components consist of reducing any unbalanced three-phase system of current (or voltage) phasors (i.e. vectors), as for example shown in Figure 1a, into three balanced systems, which are known as the zero, positive and negative phase sequence component sets:

- The zero phase sequence component set consists of three phasors (e.g. IA_0 , IB_0 & IC_0) which are equal in magnitude and in phase, as shown in Figure 1b;
- The positive sequence component set consists of three phasors (e.g. IA_1 , IB_1 & IC_1) which are equal in magnitude, 120 degrees out of phase and rotating in typically anticlockwise direction, so that they reach their positive maximum values in a sequence ABC as shown in Figure 1c; and
- The negative sequence component set are three phasors (e.g. IA_2 , IB_2 & IC_2) which are equal in magnitude and displaced 120 degrees apart and rotating in a sequence ACB, as shown in Figure 1d.

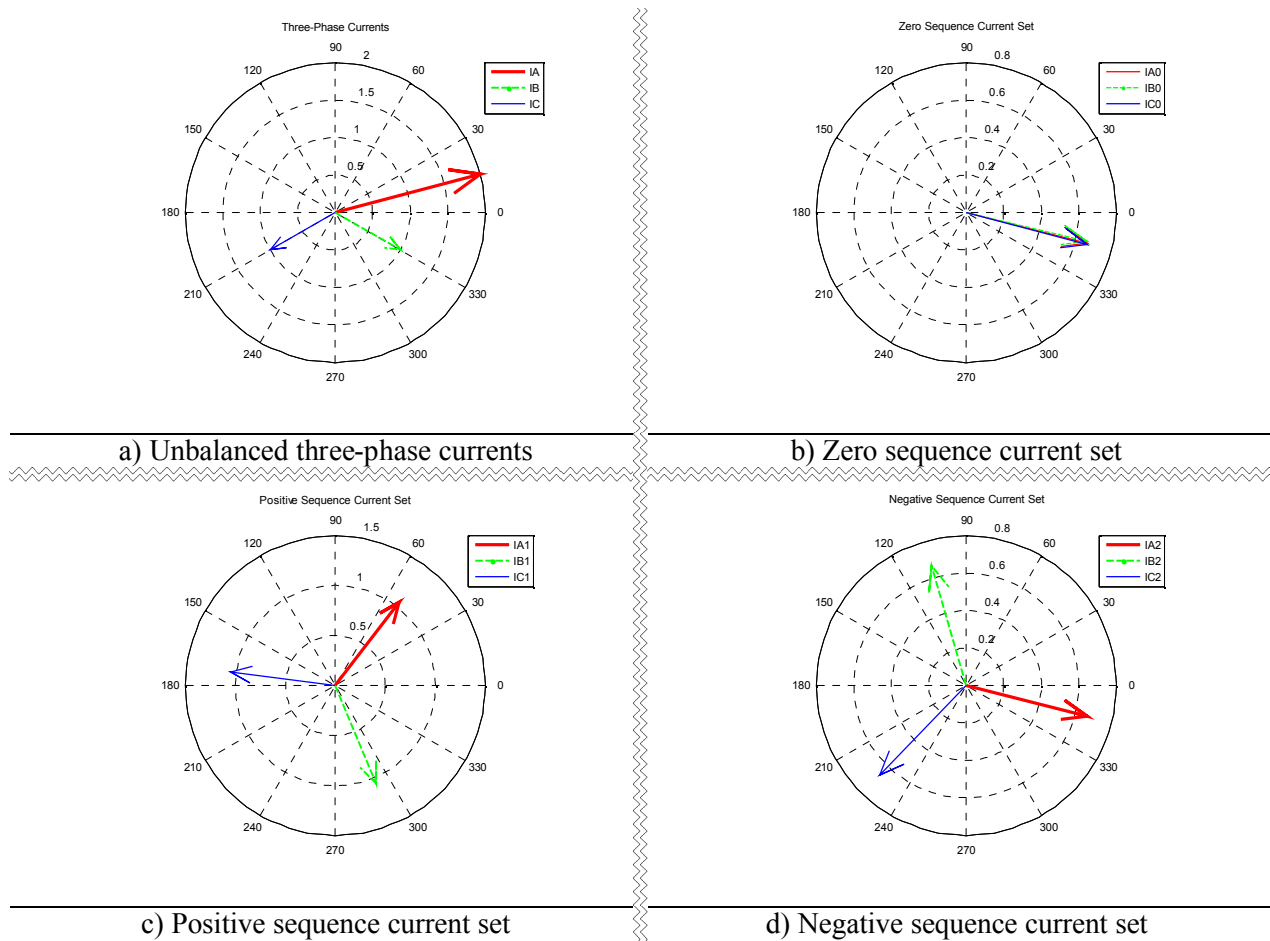

Figure 1: Unbalanced three-phase currents reduced into three balanced sequence current sets

It is most important to emphasize that any of these three sets of sequence quantities always exist as defined (i.e. as phasor triplet). Thus IA1 or IB1 or IC1 can *never* exist alone or in pairs, *always* all three. For engineering calculation purposes it is necessary to define only one phasor in each sequence (typically IA1, IA2 and IA0), from which the other two phasors of the same sequence can be easily calculated. This is the reason why we typically say that positive negative and zero sequence component is calculated with phase A as a reference. The following phasor equations, given in the literature [10] and [11], shall be used to calculate the first sequence phasor of every component set:

$$IA0 = |IA0| \angle \delta_0 = \frac{1}{3} \cdot (IA + IB + IC)$$

$$IA1 = |IA1| \angle \delta_1 = \frac{1}{3} \cdot (IA + a \cdot IB + a^2 \cdot IC)$$

$$IA2 = |IA2| \angle \delta_2 = \frac{1}{3} \cdot (IA + a^2 \cdot IB + a \cdot IC)$$

Where \mathbf{a} is complex operator having value of $a = 1 \angle 120^\circ = \frac{1}{2} + j \cdot \frac{\sqrt{3}}{2} = -0.5 + j \cdot 0.866$ (i.e. it is a unit phasor with angle displacement of 120°).

Once these basic sequence components are known the complete sequence sets can be calculated as shown below:

Zero sequence set	Positive sequence set	Negative sequence set
$IA_0 = IA_0 @ \angle \delta_0$	$IA_1 = IA_1 @ \angle \delta_1$	$IA_2 = IA_2 @ \angle \delta_2$
$IB_0 = IA_0 @ \angle \delta_0$	$IB_1 = IA_1 @ \angle (\delta_1 + 240^\circ)$	$IB_2 = IA_2 @ \angle (\delta_2 + 120^\circ)$
$IC_0 = IA_0 @ \angle \delta_0$	$IC_1 = IA_1 @ \angle (\delta_1 + 120^\circ)$	$IC_2 = IA_2 @ \angle (\delta_2 + 240^\circ)$

Note that from these three sequence sets it is always possible to re-assemble the three individual phase-wise current phasors by using the following three equations:

$$IA = IA_0 + IA_1 + IA_2$$

$$IB = IB_0 + IB_1 + IB_2$$

$$IC = IC_0 + IC_1 + IC_2$$

1.2 Power Transformer Theory

Typical voltage and current definitions used for a three-phase, two-winding power transformer is shown in Figure 2.

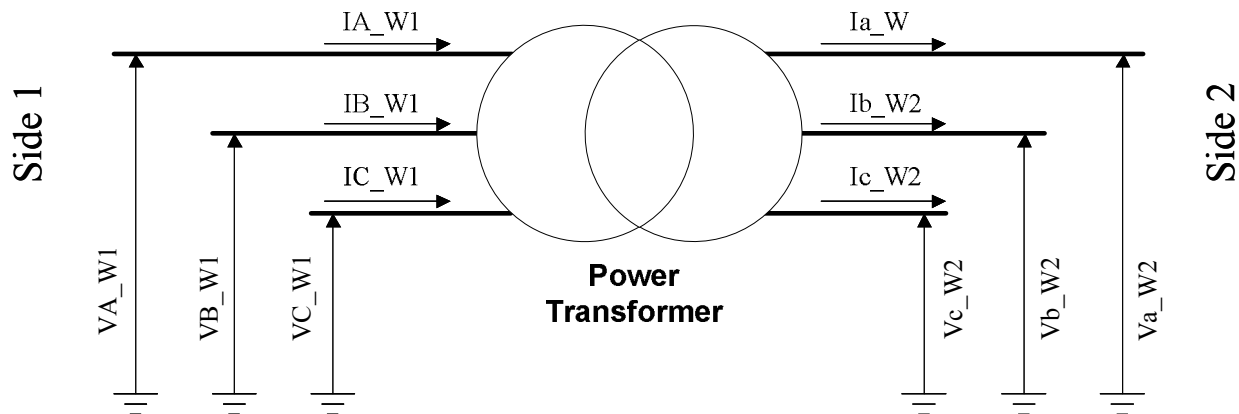

Figure 2: Typical voltage and current reference direction for a power transformer

Any three-phase power transformer introduces the phase angle shift Θ between the two sides. The standard three-phase power transformers introduce a fixed phase angle shift Θ of $n \cdot 30^\circ$ ($n=0, 1, 2, \dots, 11$) between its winding 1 and winding 2 side no-load voltages.

Note that for any three-phase power transformer strict rules only exist for the phase angle shift between sequence components of the no-load voltages from the two sides of the power transformer (see Figure 3), but not for individual phase voltages from the two sides of the power transformer. For more information about these rules and their use for transformer differential protection see references [5], [8] and [9].

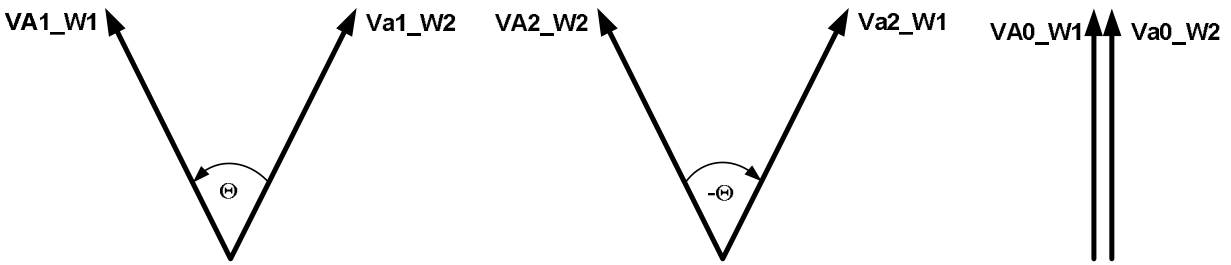

Figure 3: Phasor diagram for no-load positive, negative & zero sequence voltages components from the two sides of the power transformers

As shown in Figure 3 the following will hold true for the positive, negative and zero sequence no-load voltage components:

- the positive sequence no-load voltage component from winding 1 (VA1_W1) will lead the positive sequence no-load voltage component from winding 2 (Va1_W2) by angle Θ ;
- the negative sequence no-load voltage component from winding 1 (VA2_W1) will lag the negative sequence no-load voltage component from winding 2 (Va2_W2) by angle Θ ; and
- the zero sequence no-load voltage component from winding 1 (VA0_W1) will be exactly in phase with the zero sequence no-load voltage component from winding 2 (Va0_W2), when the zero sequence no-load voltage components are at all transferred across the power transformer.

Most typically used power transformer connections and associated phase angle shift Θ are presented in Table 1.

However, as soon as the power transformer is loaded, this voltage relationship will not longer be valid, due to the voltage drop across the power transformer impedance. However it can be shown that the same phase angle relationship, as shown in Figure 3, will be valid for sequence current components [5], as shown in Figure 4, which flow into the power transformer on winding 1 side and flow out from the power transformer on winding 2 side (see Figure 2 for current reference directions).

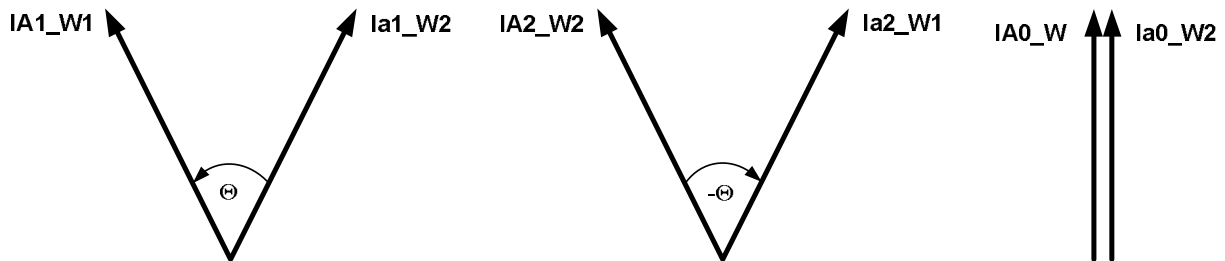
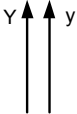
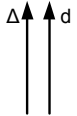
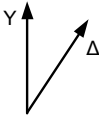
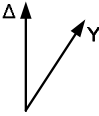
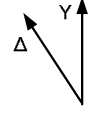
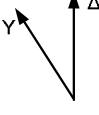

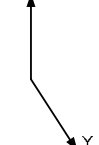
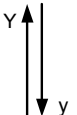

Figure 4: Phasor diagram for positive, negative & zero sequence current components from the two sides of the power transformers

Table 1: Most commonly used three-phase power transformer connections

IEC Vector Group	ANSI Designation	Positive Sequence no-load voltage phasor diagram	Phase angle shift Θ introduced by the power transformer
YNyn0	Y_0Y_0		0°
Dd0	$D_{AC}D_{AC}$		0°
YNd1	YD_{AC}		30°
Dyn1	$D_{AB}Y$		30°
YNd11	YD_{AB}		-30°
Dyn11	$D_{AC}Y$		-30°
YNd5	$YD150$		150°
Dyn5	$DY150$		150°
YNyn6	Y_0Y_{180}		180°

As shown in Figure 4, the following will hold true for the sequence current components from the two power transformer sides:

- the positive sequence current component from winding 1 (I_{A1_W1}) will lead the positive sequence current component from winding 2 (I_{a1_W2}) by angle Θ (the same relationship as for the positive sequence no-load voltage components);
- the negative sequence current component from winding 1 (I_{A2_W1}) will lag the negative sequence current component from winding 2 (I_{a2_W2}) by angle Θ (the same relationship as for the negative sequence no-load voltage components); and
- the zero sequence current component from winding 1 (I_{A0_W1}) will be exactly in phase with the zero sequence current component from winding 2 (I_{a0_W2}), when the zero sequence current components are at all transferred across the transformer (the same relationship as for the zero sequence no-load voltage components).

These properties can be used to test the numerical differential protection of any manufacturer as described further in this document. Namely, if testing is based on injecting only one sequence current component at the time on both CT inputs of the transformer differential protection, simple testing procedures can be derived, which are more intuitive, less complex and straightforward than existing phase-wise testing procedures. It is well known fact that fault currents for any type of external or internal faults can be represented by the positive, negative and zero sequence current component sets. Thus, by performing transformer differential protection tests in a sequence-wise fashion it is verified that the differential protection will be stable for all symmetrical and non-symmetrical external faults and through-load conditions. These tests will also confirm that the differential relay will trip for any internal fault.

2. Basis for the New Testing Principle

In order to provide transformer differential protection for a three-phase power transformer, it is necessary to properly compensate for:

- current magnitude compensation for measured current magnitude difference on different sides of the protected transformer;
- power transformer phase angle shift compensation; and
- zero sequence current compensation (i.e. zero sequence current elimination).

With static (or even electromechanical) differential relays [2] such compensations were performed by using interposing CTs or special connection of main CTs (i.e. delta connected CTs). Maximum rated apparent power of the protected transformer was used to calculate the interposing CT ratios [2], [13] on all transformer sides. However, the interposing CTs could only be calculated for the mid-position of the on-load tap-changer (LTC). Thus, as soon as the LTC is moved from the mid-position, false differential currents would appear. A typical differential protection scheme with interposing CTs is given in Figure 5.

With modern numerical transformer differential relays [3], [4] external interposing CTs are not required because relay software enables the user to perform all necessary compensation in software. Some particular relays can even compensate on-line for LTC movement [3], [4] and [7]. Thus, it can be quite tricky to test a numerical transformer differential relay by secondary injection in order to verify that the relay is set properly to protect transformer in a particular application. Additional complication is used connections for main current transformers. Typically all star (i.e. wye) connected main CTs are used with numerical relays, as shown in Figure 6; however in some countries delta connected main CTs are still applied.

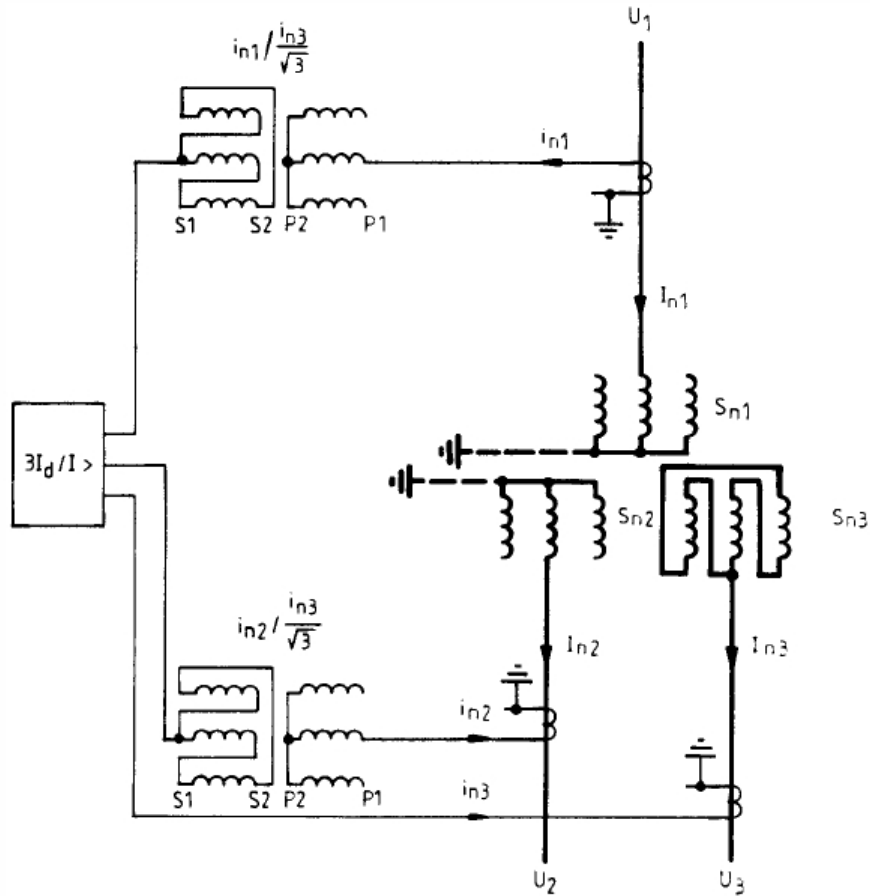

Figure 5: Power transformer differential protection scheme with interposing CTs [2]

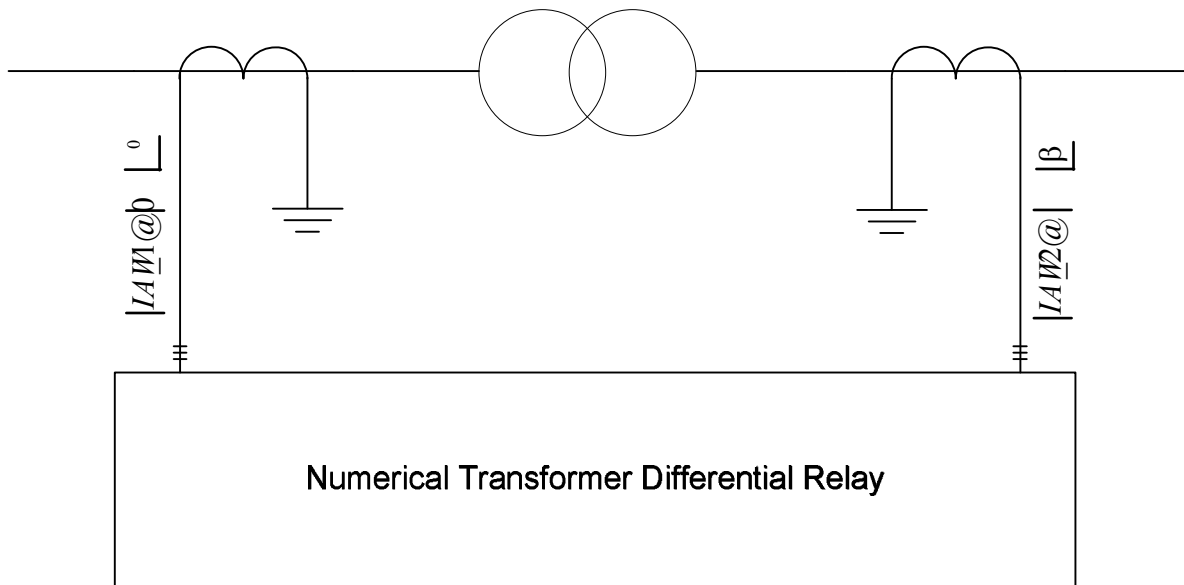

Figure 6: Typical connections for transformer differential protection relay

The main task during secondary injection testing of the transformer differential protection is to inject the secondary currents with appropriate magnitude and phase angles in order to test the differential relay. For example, in order to test differential relay stability the injected current must correspond to the CT secondary currents as seen by the differential relay during external disturbances (e.g. symmetrical/unsymmetrical load, different types of external faults), as shown in Figure 6.

If testing is performed on phase-wise bases, what is typically used today, necessary calculations in order to derive individual phase currents on both side of the protected power transformers become quite complicated. Especially if it is required to inject different types of internal and external faults complex mathematics (i.e. phasors) must be used. The reason for this is that there are no strict rules how the individual phase currents are transferred across a power transformer.

However, as explained in previous section, strict rules exist how the sequence current sets are transfer across any three-phase power transformer [5], [9]. Thus, if the secondary injection is based on sequence quantities (i.e. injecting only one type of sequence current set at the time on both power transformer sides) all necessary calculations becomes quite simple and algebraic mathematics utilizing only real numbers can be used instead. Such testing approach will be presented in this paper.

2.1 Determining appropriate CT secondary current magnitudes for injection

In order to perform secondary injection the appropriate magnitude of the secondary currents shall be determined. It is well known fact that two power transformer windings are galvanically separated and have different voltage and current levels on the primary side. Thus the only common electrical quantity for two windings is electrical power which flows through them. Therefore for the transformer differential protection the maximum apparent power among all power transformer windings is typically selected as the base quantity [9]. That was the reason why interposing CTs for the solid-state relays were as well calculated using this maximum power as a base. Note that the maximum value among all windings, as stated on the protected power transformer rating plate, is typically selected. This can be simply written as following equation:

$$S_{Base} = S_{Max} \text{ [MVA]}$$

When the base power is know the base primary current on each power transformer side can be calculated by using the following equation:

$$I_{BasePri_Wi} \text{ [A]} = \frac{1000 \cdot S_{Base} \text{ [MVA]}}{\sqrt{3} \cdot U_{r_Wi} \text{ [kV]}}$$

where:

- $I_{BasePri_Wi}$ is winding base current in primary amperes
- S_{Base} is above defined base apparent power for this application in MVA
- U_{r_Wi} is winding rated phase-to-phase, no-load voltage in kV; its value for every winding is typically stated on the protected power transformer rating plate.

Note that when a power transformer incorporates an on-load tap-changer (i.e. LTC) different rated phase-to-phase, no-load voltages are given, one for each tap for at least one of the windings. Than it is necessary to select a rated voltage for a one given tap for which it is required to perform the testing. Typically the mid-tap value is used. Alternatively relay can be tested for more than one LTC position.

However for the secondary injection the CT secondary base current is required. For star connected main CT this value is easily obtained by using the following equation:

$$I_{BaseSec_Wi_CT=Y} = \frac{I_{BasePri_Wi}}{CTR}$$

where:

- $I_{BaseSec_Wi_CT=Y}$ is winding base current in secondary amperes for wye connected main CT
- $I_{BasePri_Wi}$ is above defined winding base current in primary amperes
- CTR is actual CT ratio used on that power transformer side

When delta connected main CT is used than factor of $\sqrt{3}$ must be taken into account as shown in next equation:

$$I_{BaseSec_Wi_CT=\Delta} = \sqrt{3} \cdot \frac{I_{BasePri_Wi}}{CTR}$$

where:

- $I_{BaseSec_Wi_CT=\Delta}$ is winding base current in secondary amperes for delta connected main CT
- $I_{BasePri_Wi}$ is above defined winding base current in primary amperes
- CTR is actual CT ratio used on that power transformer side

Please refer to Table 3 for an example.

2.2 Determining appropriate CT secondary current phase angles for injection

In order to perform secondary injection, appropriate phase angle for the secondary currents shall also be determined in addition to the known current magnitudes. Because we are going to inject only one sequence set at the time it is only important to determine the relative phase angle displacement between the same sequence current sets from the two transformer side. Therefore for the positive sequence current injection it is possible to fix the angle for IA1_W1 to zero degree and just determine the appropriate angle for Ia1_W2 phasor. Let's call this angle β_1 .

Similarly for the negative sequence current injection it is possible to fix the angle for IA2_W1 to zero degree and just determine the appropriate angle for Ia2_W2 phasor. Let's call this angle β_2 .

These two angles (i.e. β_1 and β_2) can be relatively easily determined because there are strict rules how current sequence component sets are transferred across power transformer. However note that these phase angle shifts depend as well on the main CT connections (i.e. main CT star or delta connected).

2.2.1 Phase angle shift with all main CTs wye connected

The following two facts determine the phase angle shift between sequence current sets on the CT secondary side:

- actual phase angle shift Θ introduced by the power transformer (see Table 1)
- star point location of the main CT (inside or outside of the differential zone)

Regarding CT star point location of the main CT it is possible to derive four different connections possibilities to the differential relay as shown in Figure 7. However from the differential relay point of view the two connections on the left hand side (e.g. Figure 7a) are equivalent. Correspondingly the two connections on the right hand side (e.g. Figure 7b) are also equivalent.

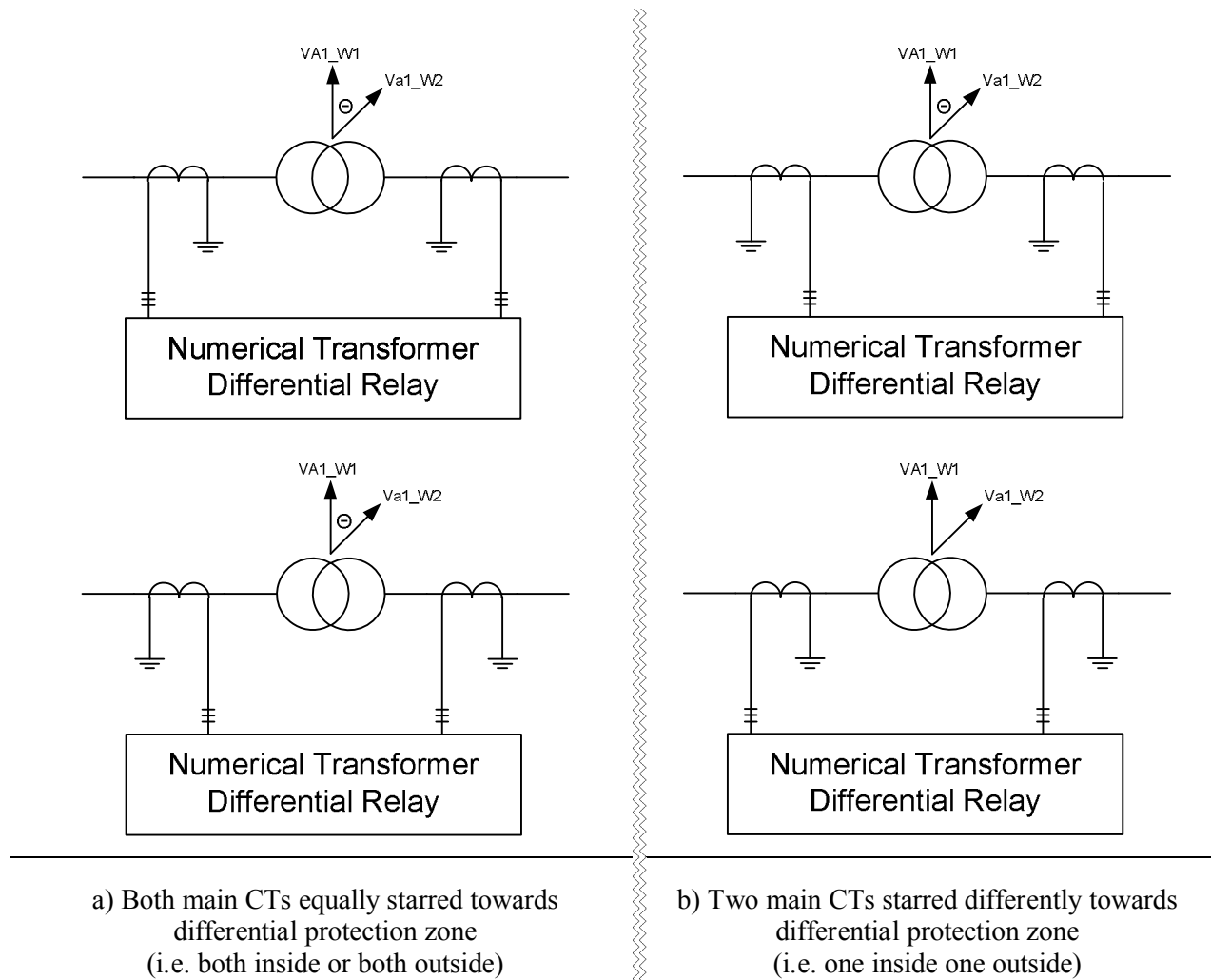

Figure 7: Possible CT arrangements for star/wye connected main CTs

It can be shown that from the differential relay point of view the positive and negative sequence current sets on the CT secondary side will have the phase angle relationship as shown in Figure 8, for the two connections shown in Figure 7a (left hand side). Note that it is assumed that the angle has a positive value for rotation in anticlockwise direction. This is typical positive direction for angles used by most of the secondary injection test sets available on the market.

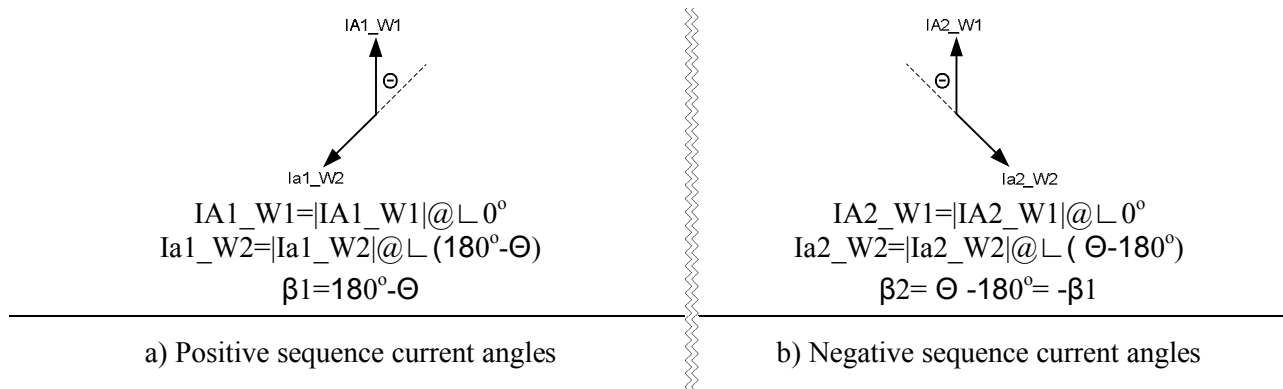

Figure 8: Phase angle relationship between sequence currents on CT secondary side for main CT connections shown in Figure 7a

Thus for this type of CT star point location secondary sequence current components have additional phase angle shift of 180° from the actual protected power transformer phase angle shift.

It can be shown that from the differential relay point of view the positive and negative sequence current sets on the CT secondary side will have the phase angle relationship as shown in Figure 9, for the main CT connections shown in Figure 7b (right hand side), when one CT is starred inside the other CT is starred outside.

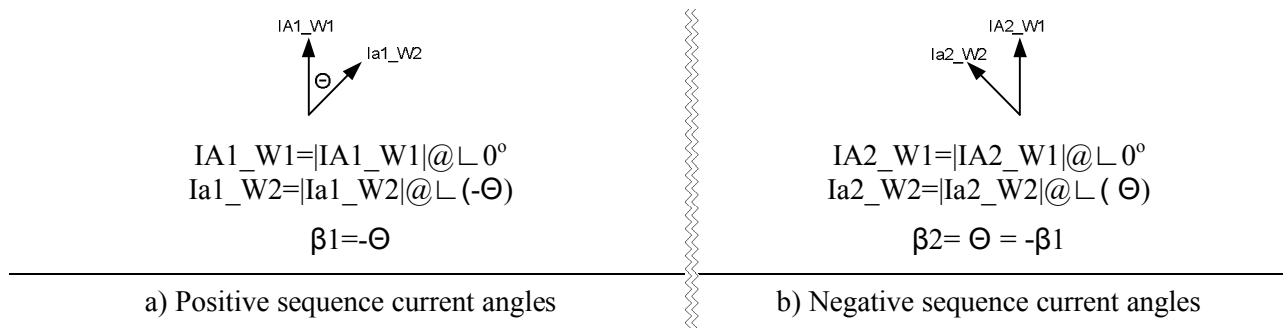

Figure 9: Phase angle relationship between sequence currents on CT secondary side for main CT connections shown in Figure 7b

Thus for this type of CT star point location secondary sequence current components have exactly the same phase angle shift as the protected power transformer.

2.2.2 Phase angle shift with some main CTs delta connected

In some countries delta connected main CTs are used. In such applications delta connected main CT are typically used for star (i.e. wye) connected power transformer windings, while star (i.e. wye) connected main CTs are used for delta connected power transformer windings. Two such applications are given in Figure 10.

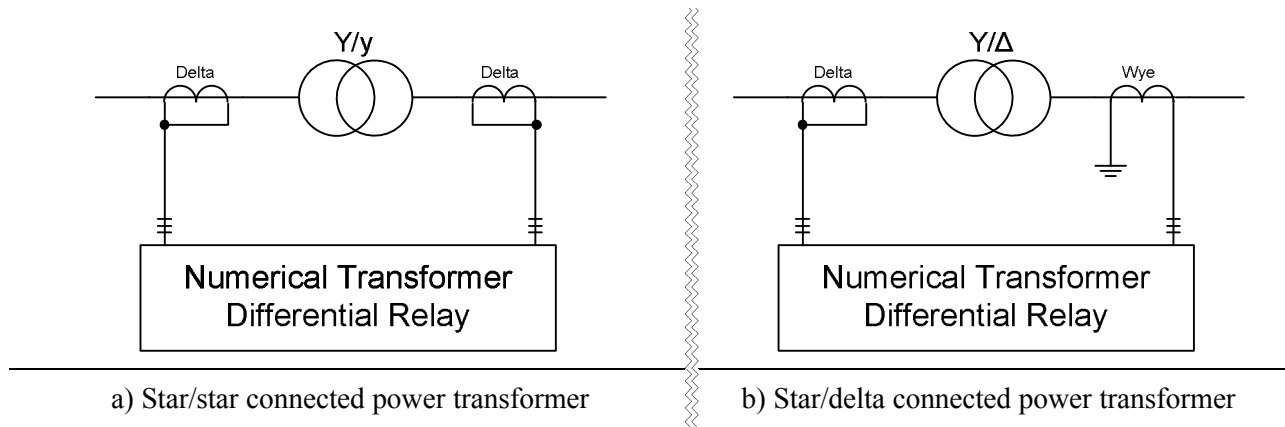

Figure 10: Typical applications where main CTs connected in delta are used

It can be shown that for such applications from the differential relay point of view the positive and negative sequence current sets on the CT secondary will typically be 180° out of phase as shown in Figure 11. Therefore for application where main CT are connected in delta, the phase angle displacement between sequence component sets on the CT secondary side do not depend on the phase angle shift of the protected power transformer.

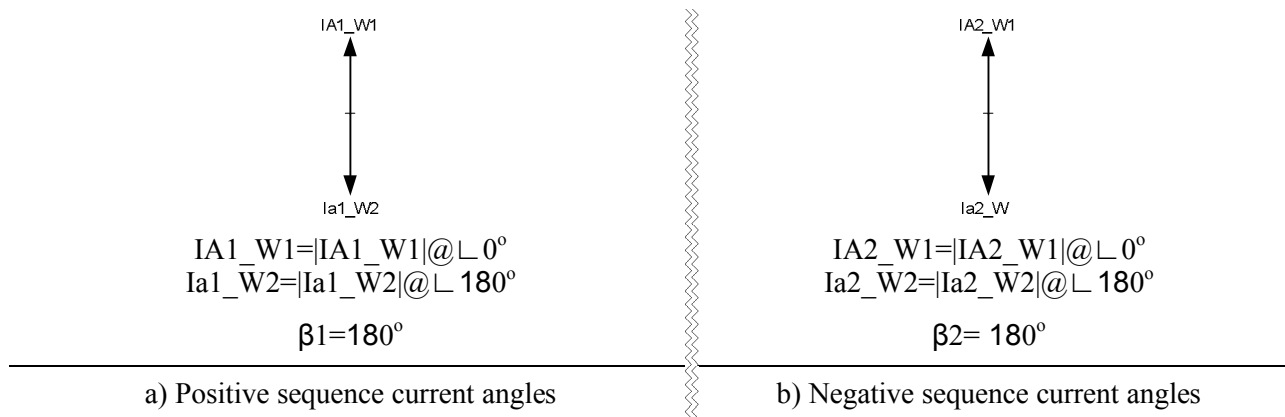

Figure 11: Phase angle relationship between sequence currents on CT secondary side when some main CTs are connected in delta (see Figure 10)

3. Proposed testing procedures

When the magnitudes and phase angle shifts between sequence current components are known the differential relay can easily be tested by using procedures presented in this section. In order to facilitate understanding of these testing procedures one application examples will be used throughout this section. However for this application two differential protection solutions will be presented:

- First solution will be with all main CTs star/wye connected
- Second solution will be with delta connected main CT on Y (i.e. star/wye) connected sides of the protected power transformer

Single line diagrams for two possible solutions for such type of power transformer with all relevant application data are given in Figure 12.

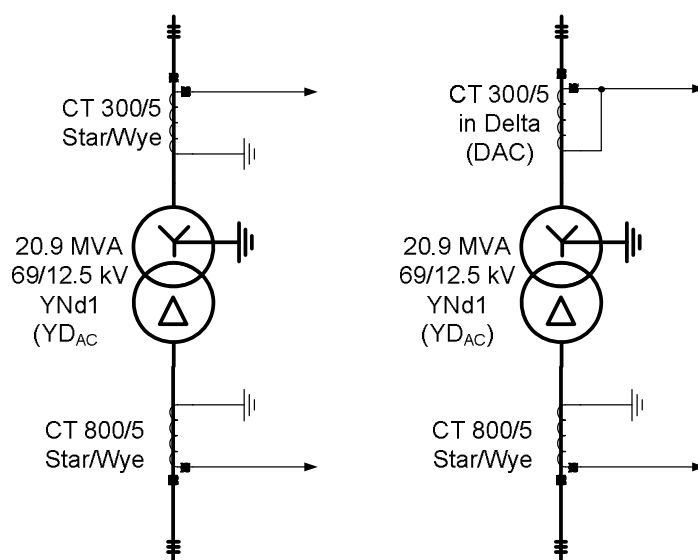

Figure 12: Two differential protection solutions for wye-delta connected power transformer

The following data can be derived for this power transformer. Data are common for both solutions regarding transformer differential protection scheme.

Table 2: Power Transformer Basic Data

S_{Base}	20.9MVA
Transformer phase angle shift Θ (see Table 1)	30°
Winding 1 rated no-load, ph-ph voltage	69kV
Winding 2 rated no-load, ph-ph voltage	12.5kV

Based on this data the following values can be calculated in accordance with the theory presented in the Section 2.

Table 3: Derived data for each of the two applications

	All main CTs star/gye connected	69kV main CTs connected in delta
Base Primary current on 69kV	$\frac{1000 \cdot 20.9}{\sqrt{3} \cdot 69} = 175A$	$\frac{1000 \cdot 20.9}{\sqrt{3} \cdot 69} = 175A$
Base current on CT secondary side for 69kV	$\frac{175}{\frac{300}{5}} = \frac{175}{60} = 2.917A$	$\sqrt{3} \frac{175}{\frac{300}{5}} = 5.052A$
Base Primary current on 12.5kV	$\frac{1000 \cdot 20.9}{\sqrt{3} \cdot 12.5} = 965A$	$\frac{1000 \cdot 20.9}{\sqrt{3} \cdot 12.5} = 965A$
Base current on CT secondary side for 12.5kV	$\frac{965}{\frac{800}{5}} = \frac{965}{160} = 6.031A$	$\frac{965}{\frac{800}{5}} = \frac{965}{160} = 6.031A$
β_1 (Required phase angle for Ia1_W2)	$180^\circ - \Theta = 180^\circ - 30^\circ = 150^\circ$	180°
β_2 (Required phase angle for Ia2_W2)	$\Theta - 180^\circ = 30^\circ - 180^\circ = -150^\circ$	180°

All required data to perform the secondary injection in accordance with the proposed method are now available in Table 3.

3.1 Differential relay suitability for particular application

Purpose of this test is to determine that the applied numerical differential relay is properly set in order to compensate for

- current magnitude compensation
- power transformer phase angle shift compensation
- zero sequence current compensation

for the particular application under test. In order to do this two tests for each sequence current component set are required as described in the following sections.

3.1.1 Relay stability for positive sequence current set with 100% currents

Only the positive sequence current sets on both transformer sides shall be injected. Injected current magnitudes shall be equal to the base current (i.e. 100%) on both transformer sides. The phase angle shift between positive sequence currents as described in Section 2.2 shall be used. The differential relay shall be stable. The test person shall check that the differential relay measures negligible differential current in all three phases (i.e. theoretically equal to zero), while for the most commonly used designs available on the market the bias current shall be 100%.

Currents as shown in Table 4 shall be injected to perform this test for the two possible differential protection solutions for example application (see Figure 12).

Table 4: Inject these currents to test stable condition with positive sequence currents

	All main CTs star/bye connected	69kV main CTs connected in delta
Injected currents into 69kV side	IA_W1=IA1_W1=2.917@L 0° IB_W1=IB1_W1=2.917@L 240° IC_W1=IC1_W1=2.917@L 120°	IA_W1=IA1_W1=5.052@L 0° IB_W1=IB1_W1=5.052@L 240° IC_W1=IC1_W1=5.052@L 120°
Injected currents into 12.5kV side	Ia_W1=Ia1_W1=6.031@L 150° Ib_W1=Ib1_W1=6.031@L 30° Ic_W1=Ic1_W1=6.031@L 270°	Ia_W1=Ia1_W1=6.031@L 180° Ib_W1=Ib1_W1=6.031@L 60° Ic_W1=Ic1_W1=6.031@L -60°

3.1.2 Relay operation for positive sequence current set with 100% currents

This is continuation of the previously described test for stability with positive sequence currents. It is only required to change the phase angle for all three currents on one transformer side by 180°. Now the differential relay shall trip in all three phases. The test person shall check that the differential relay measures differential current of 200% in all three phases, while for the most commonly used differential relay designs available on the market the bias current shall still have value of 100%.

Currents as shown in Table 5 shall be injected to perform this test for the two possible differential protection solutions for example application (see Figure 12).

Table 5: Inject these currents to test relay operation with positive sequence currents

	All main CTs star/bye connected	69kV main CTs connected in delta
Injected currents into 69kV side	IA_W1=IA1_W1=2.917@L 0° IB_W1=IB1_W1=2.917@L 240° IC_W1=IC1_W1=2.917@L 120°	IA_W1=IA1_W1=5.052@L 0° IB_W1=IB1_W1=5.052@L 240° IC_W1=IC1_W1=5.052@L 120°
Injected currents into 12.5kV side	Ia_W1=Ia1_W1=6.031@L -30° Ib_W1=Ib1_W1=6.031@L 210° Ic_W1=Ic1_W1=6.031@L 90°	Ia_W1=Ia1_W1=6.031@L 0° Ib_W1=Ib1_W1=6.031@L 240° Ic_W1=Ic1_W1=6.031@L 120°

3.1.3 Relay stability for negative sequence current set with 100% currents

Only the negative sequence current sets on both transformer sides shall be injected. Injected current magnitudes shall be equal to the base current (i.e. 100%) on both transformer sides. The phase angle shift between negative sequence currents as described in Section 2.2 shall be used. The differential relay shall be stable. The test person shall check that the differential relay measures negligible differential current in all three phases (i.e. theoretically equal to zero), while for the most commonly used designs available on the market the bias current shall be 100%.

Currents as shown in Table 6 shall be injected to perform this test for the two possible differential protection solutions for example application (see Figure 12).

Table 6: Inject these currents to test stable condition with negative sequence currents

	All main CTs star/gye connected	69kV main CTs connected in delta
Injected currents into 69kV side	IA_W1=IA2_W1=2.917@L 0° IB_W1=IB2_W1=2.917@L 120° IC_W1=IC2_W1=2.917@L 240°	IA_W1=IA2_W1=5.052@L 0° IB_W1=IB2_W1=5.052@L 120° IC_W1=IC2_W1=5.052@L 240°
Injected currents into 12.5kV side	Ia_W2=Ia2_W2=6.031@L -150° Ib_W2=Ib2_W2=6.031@L -30° Ic_W2=Ic2_W2=6.031@L 90°	Ia_W2=Ia2_W2=6.031@L 180° Ib_W2=Ib2_W2=6.031@L -60° Ic_W2=Ic2_W2=6.031@L 60°

3.1.4 Relay operation for negative sequence current set with 100% currents

This is continuation of the previously described test for stability with negative sequence currents. It is only required to change the phase angle for all three currents on one transformer side by 180°. Now the differential relay shall trip in all three phases. The test person shall check that the differential relay measures differential current of 200% in all three phases, while for the most commonly used differential relay designs available on the market the bias current shall still have value of 100%.

Currents as shown in Table 7 shall be injected to perform this test for the two possible differential protection solutions for example application (see Figure 12).

Table 7: Inject these currents to test relay operation with negative sequence currents

	All main CTs star/gye connected	69kV main CTs connected in delta
Injected currents into 69kV side	IA_W1=IA2_W1=2.917@L 0° IB_W1=IB2_W1=2.917@L 120° IC_W1=IC2_W1=2.917@L 240°	IA_W1=IA2_W1=5.052@L 0° IB_W1=IB2_W1=5.052@L 120° IC_W1=IC2_W1=5.052@L 240°
Injected currents into 12.5kV side	Ia_W2=Ia2_W2=6.031@L 30° Ib_W2=Ib2_W2=6.031@L 150° Ic_W2=Ic2_W2=6.031@L -90°	Ia_W2=Ia2_W2=6.031@L 0° Ib_W2=Ib2_W2=6.031@L 120° Ic_W2=Ic2_W2=6.031@L 240°

3.1.5 Relay behavior for zero sequence current injected from winding one side only

Typically the zero sequence currents are not properly transferred across the protected power transformer. Therefore the stability test is not required. However it is of outmost importance to test differential relay behavior for zero sequence currents.

To do that for winding one side inject the zero sequence current set from the winding one side only. Injected current magnitudes shall be equal to the base current (i.e. 100%). All three currents shall be in phase. The differential relay will either trip or remain stable during such test.

If differential relay trips it means that the relay do NOT removes the zero sequence current from that side. First check that the relay measures differential current of 100% in all three phases. Then look into the application and check is there any grounding connection on that side of the power transformer within differential protection zone. Typical example for such grounding connections are directly grounded star point of the wye connected windings or an earthing transformer within the differential protection zone. If such grounding connection exist the relay is not properly set. It might maloperate for an external ground faults on that transformer side. Rectify the corresponding relay setting and repeat the test.

If differential relay do not trip it means that the relay removes the zero sequence current from that side. Note that there is no any sense to perform this test on side where main CTs are connected in delta. The reason is that the delta connected main CT filter out the zero sequence current component set on that side of the transformer.

For the application example (see Figure 12), currents as shown in Table 8, shall be injected to perform this test.

Table 8: Inject these currents into winding 1 side to test relay operation for zero sequence currents

	All main CTs star/wye connected	69kV main CTs connected in delta
Injected currents into 69kV side	IA_W1=IA0_W1=2.917@L 0° IB_W1=IB0_W1=2.917@L 0° IC_W1=IC0_W1=2.917@L 0°	Not required to be done because the CTs are star connected
Injected currents into 12.5kV side	No currents shall be injected	No currents shall be injected

Note that for this application the zero sequence current from 69kV side must be eliminated. Thus, the differential relay shall not operate during this test! If the relay operates during this test possible unwanted operation of the relay for external single phase to ground fault on 69kV side can be expected.

3.1.6 Relay behavior for zero sequence current injected from winding two side only

This is repetition of the previous test but from winding two side. Exactly the same procedure shall be repeated here as in the previous test.

For the application example (see Figure 12), currents as shown in Table 9, shall be injected to perform this test.

Table 9: Inject these currents into winding 2 side to test relay operation for zero sequence currents

	All main CTs star/wye connected	69kV main CTs connected in delta
Injected currents into 69kV side	No currents shall be injected	No currents shall be injected
Injected currents into 12.5kV side	Ia_W2=Ia0_W2=6.031@L 0° Ib_W2=Ib0_W2=6.031@L 0° Ic_W2=Ic0_W2=6.031@L 0°	Ia_W2=Ia0_W2=6.031@L 0° Ib_W2=Ib0_W2=6.031@L 0° Ic_W2=Ic0_W2=6.031@L 0°

Note that for this application the zero sequence current elimination on 12.5kV side is not critical. The reason is that there is no grounding point on the 12.5kV side within the differential protection zone. Therefore it is not critical if differential relay operates for this zero sequence current injection.

3.2 Testing the differential relay operating characteristic

Once the previous tests are successfully passed the differential relay is properly set to protect the particular transformer. However, very often the differential relay operating characteristic shall be tested as well. A typical operating characteristic of the numerical transformer differential relay is shown in Figure 13. Some of the typical tests are described below:

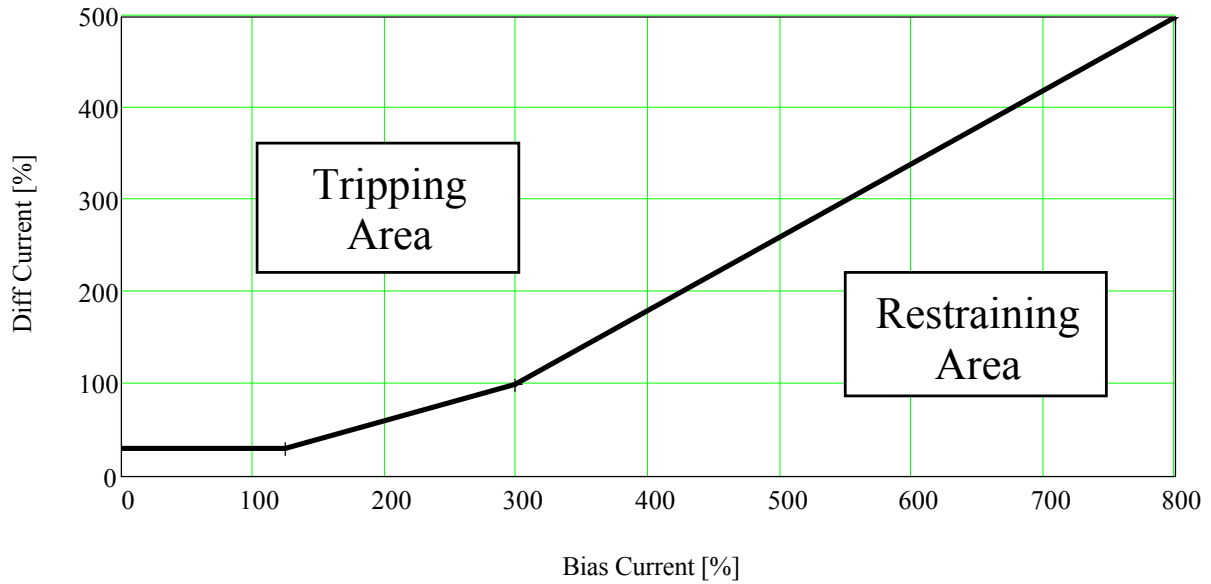

Figure 13: Differential relay operating characteristic

3.2.1 Testing minimum pickup of the differential protection

In Figure 13 the minimum pickup for this relay is set to 30% what is typical value for transformer differential protection. In order to test this value the easiest way is to inject symmetrical three-phase current set (e.g. positive sequence set only) from one transformer side at the time.

For the application example (see Figure 12), currents as shown in Table 10, shall be injected from the 69kV side in order to perform this test.

Table 10: Inject these currents to test relay minimum pickup from 69kV side

	All main CTs star/ye connected	69kV main CTs connected in delta
Injected currents into 69kV side	$IA_W1=IA1_W1=0.875@_{\perp} 0^{\circ}$ $IB_W1=IB1_W1=0.875@_{\perp} 240^{\circ}$ $IC_W1=IC1_W1=0.875@_{\perp} 120^{\circ}$	$IA_W1=IA1_W1=1.516@_{\perp} 0^{\circ}$ $IB_W1=IB1_W1=1.516@_{\perp} 240^{\circ}$ $IC_W1=IC1_W1=1.516@_{\perp} 120^{\circ}$
Injected currents into 12.5kV side	No currents shall be injected	No currents shall be injected

Note that when these currents are injected the differential relay shall be exactly at the pickup point. It might be necessary to slightly increase current in all three phases in order to get relay operation. Write down the actual pickup current for this three-phase injection. Make sure that differential relay operates in all three phases.

For the application example (see Figure 12), currents as shown in Table 11, shall be injected from the 12.5kV side in order to perform this test.

Table 11: these currents to test relay minimum pickup from 12.5kV side

	All main CTs star/wye connected	69kV main CTs connected in delta
Injected currents into 69kV side	No currents shall be injected	No currents shall be injected
Injected currents into 12.5kV side	$I_{a_W2}=I_{a1_W2}=1.809@_{\perp} 0^{\circ}$ $I_{b_W2}=I_{b1_W2}=1.809@_{\perp} 240^{\circ}$ $I_{c_W2}=I_{c1_W2}=1.809@_{\perp} 120^{\circ}$	$I_{a_W2}=I_{a1_W2}=1.809@_{\perp} 0^{\circ}$ $I_{b_W2}=I_{b1_W2}=1.809@_{\perp} 240^{\circ}$ $I_{c_W2}=I_{c1_W2}=1.809@_{\perp} 120^{\circ}$

Note that when these currents are injected the differential relay shall be exactly at the pickup point. It might be necessary to slightly increase current in all three phases in order to get relay operation. Write down the actual pickup current for this three-phase injection. Make sure that differential relay operates in all three phases.

Sometimes it is as well required to test and verify the single phase differential relay pickup (i.e. minimum pickup current value when only one phase current is injected at the time on one side of the transformer). This pickup value can be expressed by using the following formula:

$$I_{1Ph_Pickup} = k \cdot I_{3Ph_Pickup}$$

Where:

I_{1Ph_Pickup} is secondary current pickup for 1-Ph injection

I_{3Ph_Pickup} is secondary current pickup for 3-Ph injection (see above two Tables)

k is a factor which is dependent on a particular relay design; typically k factor will have one among the following values 1.0; 1.5 or 1.732; note that from different power transformer sides the k factor may have different values.

3.2.2 Testing the differential relay operating characteristic

The injection principles as shown in Section 3.1.1 (i.e. positive sequence current sets only used on both transformer sides) can be utilized to test the entire differential relay operating characteristic as shown in Figure 13. In order to test one point on the characteristic the currents as shown in Table 4 shall be injected. Relay shall be fully stable (i.e. differential currents in all three phases shall be equal to zero). Then the current magnitudes on winding 2 side shall be rump down symmetrically (i.e. equally in all three phases) until the differential relay operates in all three phases. Write down the side 2 currents in secondary amperes as well as in percent (by dividing the secondary amperes with winding 2 base currents and multiplying by 100). Now the differential current will be the simple algebraical difference between the winding one and winding 2 currents expressed in percent. Similarly these two percentage values shall be used to calculate the bias current in accordance with formula given in differential relay manual (i.e. maximum of the two, minimum of the two, sum of the two or average of the two percentage values). The same procedure can be now repeated for different current levels on the two sides of the protected transformer. Simple EXCEL worksheet can be created to test a particular differential relay operating characteristic as for example shown in Figure 14 for a particular relay [4] (note that the values given in this Figure do not correspond to the previously used application example shown in Figure 12). The EXCEL can also be used to automatically plot the differential relay operating characteristic as shown in Figure 15. Note that all calculations performed by EXCEL work sheet are algebraical (i.e. no mathematics with complex numbers is required).

Idmin[%]= 40
CurveNo= 4

Smax[MVA]= 40,0

Winding_1
Ur[kV]= 132,0
CT_Primary= 250
CT_Secondary= 1
Ibase [Primary A]= 175
Ibase [Secondary A]= 0,700

Winding_2
Ur[kV]= 69,0
CT_Primary= 600
CT_Secondary= 1
Ibase [Primary A]= 335
Ibase [Secondary A]= 0,558

Substation: Västerås
Transformer: T1
Test Date: 2004-03-17

If CTs on two sides are earthed both inside or both outside please inject positive sequence currents on the two sides with phase shift of "Vector Group+180 degree" (i.e. 180 degrees in case of Yy0 transformer)
 If CTs on two sides are earthed one inside and one outside please inject positive sequence currents on the two sides with phase shift of "Vector Group" (i.e. 0 degrees in case of Yy0 transformer)

Bias Points to be Tested [pu]	W1 Start Current [A_Secondary]	W2 Start Current [A_Secondary]	Diff Current for the given Bias values [pu]	Expected W2 Trip Current [A_Secondary]	Measured W2 Current at Trip [A_Secondary]	Actual Diff Current at Trip [pu]	Diff Current Error in [%]
0,45	0,315	0,251	0,40	0,028	0,028	0,40	0,00
0,70	0,490	0,390	0,40	0,167	0,167	0,40	0,00
1,00	0,700	0,558	0,40	0,335	0,335	0,40	0,00
1,25	0,875	0,697	0,40	0,474	0,474	0,40	0,00
1,50	1,050	0,837	0,50	0,558	0,558	0,50	0,00
2,00	1,400	1,116	0,70	0,725	0,725	0,70	0,00
2,50	1,750	1,395	0,90	0,893	0,893	0,90	0,00
3,00	2,099	1,673	1,13	1,046	1,046	1,13	0,00
3,50	2,449	1,952	1,38	1,185	1,185	1,38	0,00
4,00	2,799	2,231	1,63	1,325	1,325	1,63	0,00
4,50	3,149	2,510	1,88	1,464	1,464	1,88	0,00
5,00	3,499	2,789	2,13	1,604	1,604	2,13	0,00
5,50	3,849	3,068	2,38	1,743	1,743	2,38	0,00
6,00	4,199	3,347	2,63	1,883	1,883	2,63	0,00
6,50	4,549	3,626	2,88	2,022	2,022	2,88	0,00
7,00	4,899	3,905	3,13	2,162	2,162	3,13	0,00

ENTER YOUR VALUES IN CELLS MARKED WITH THIS YELLOW COLOR

Figure 14: Extract from EXCEL worksheet used for RET 521*2.5 testing

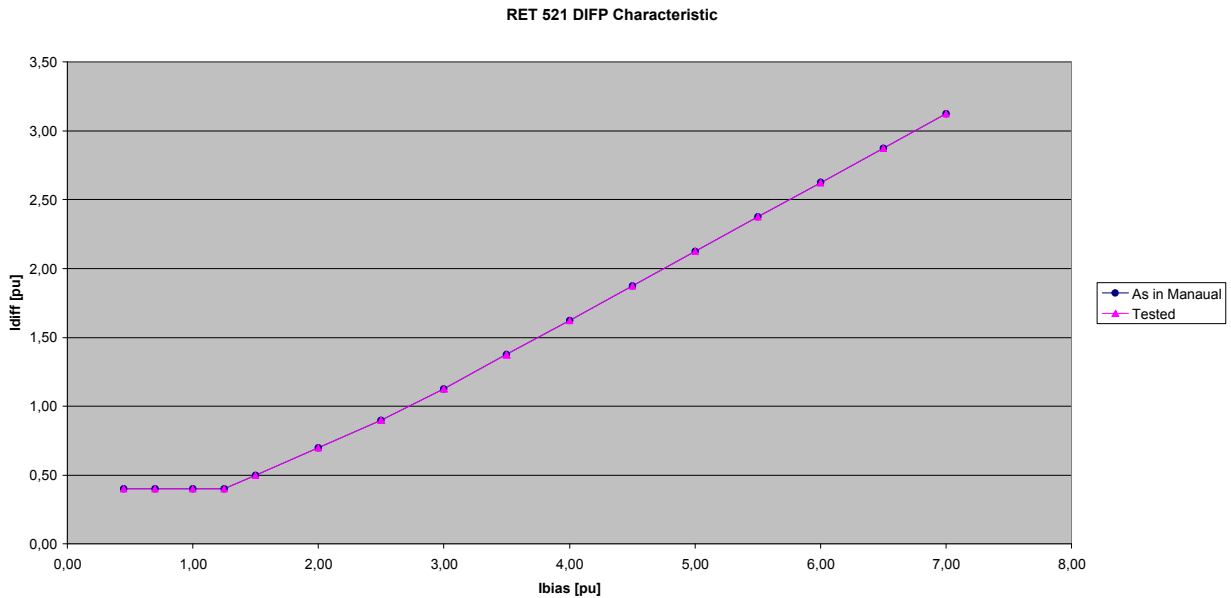

Figure 15: Graphical result for the tested characteristic

3.2.3 Testing unrestraint pickup of the differential protection

Often transformer differential relays include unrestraint operating level. This level can be tested in using exactly the same methodology as shown in Section 3.2.1 for the minimum pickup. The only difference is that instead of 30% actual value for unrestraint pickup level (e.g. 800%) shall be used in order to calculate the required secondary current magnitudes. Because typically relatively high secondary current magnitudes are required, especially if single phase injection is performed, additional care must be taken in order not to overload/burn the ct inputs into the differential relay.

4. Conclusions

The proposed method can be effectively used for testing of any numerical, three-phase power transformer differential protection regardless its make. It is well known fact that fault currents for any type of external or internal faults can be represented by the positive, negative and zero sequence current component sets. Thus, by performing transformer differential protection tests in a sequence-wise fashion it is verified that the differential protection will be stable for all symmetrical and non-symmetrical external faults and through-load conditions. These tests will also confirm that the differential relay will operate (i.e. trip) for any internal fault.

By using this method it is possible to test the differential protection for an n-winding transformer by testing in between two windings at a time. However, note that the value for maximum transformer power shall ALWAYS be used for the base current calculations on all sides of the protected power transformer. It is sufficient to test winding 1 side against all other windings (one at the time) in order to verify proper operation of the relay for all operating conditions.

It shall be noted that exactly the same testing method can be applied on traditional, analogue transformer differential protection schemes utilizing interposing CTs to perform magnitude and phase angle compensation. The only prerequisite is that the currents are injected into the primary windings of the interposing CTs and not directly into the differential relay. By doing so, the complete differential protection scheme consisting of interposing CTs and the analogue differential relay are verified.

The only drawback of this test method is that a secondary injection test set with six current generators is required. However this is typically not a limitation with modern secondary test equipment.

5. Reference:

- [1] Elmore W A, 1995, "Protective Relaying Theory and Applications", ABB
- [2] RADS B User's Guide, 1MRK 504 002-UEN, ABB
- [3] RET670 Technical reference manual, 1MRK 504 086-UEN, ABB
- [4] RET521 Application manual, 1MRK 504 037-UEN, ABB
- [5] Electrical Transmission and Distribution reference Book, Westinghouse Electric Cooperation
- [6] ABB Transformer Handbook, Document Number 1LAC 000 010
- [7] F.Mekic, Z. Gajić, S. Ganesan "Adaptive Features on Numerical Differential Relays", (29th Annual Western Protective relay Conference, Spokane, WA, October 22-24, 2002)
- [8] Z. Gajić, "Differential Protection Methodology for Arbitrary Three-Phase Power Transformer", DPSP 2008 Conference, Glasgow, UK, March 2008
- [9] Z. Gajić, "Differential Protection for Arbitrary Three-Phase Power Transformer", PhD Thesis, Lund University, Sweden, February 2008, ISBN: 978-91-88934-47-5
- [10] C.F. Wagner, R.D. Evans, Symmetrical Components, Mc Graw-Hill, 1933
- [11] J.L. Blackburn, Symmetrical Components for Power System Engineering, Marcel Dekker, 1993, ISBN: 0-8247-8767-6
- [12] Application Note "Universal Testing Method for Power Transformer Differential Protection", SA2008-000355, ABB, available at: www.abb.com/substationautomation
- [13] Instruction for Planning Differential Protection Schemes, CH-ES 53-10 E, BBC January 1980

Zoran Gajić (M'95) was born in Serbia in 1965. He received his Diploma Engineer Degree with honors in electrical power engineering from University of Belgrade, Serbia in 1990 and Graduate Diploma in Engineering in computer engineering from Witwatersrand University, Johannesburg, South Africa in 1995. Currently he is a part-time, post-graduate student at Lund University, Sweden where he is pursuing the PhD Degree. Since 1993 he has been working in the area of power system protection and control within ABB Group of companies, where he had various engineering positions. Currently he has a position of Product Application Specialist with ABB AB, Substation Automation Products in Vasteras, Sweden. Zoran is a member of Cigré and IEEE/PES. Presently he is the convener for Cigré, Study Committee B5, WG16 “Modern Techniques for Protecting Busbars in HV Networks”. He has published numerous technical papers in the relay protection area. His main working areas are practical applications of protection relays, computer applications for protection and control of electrical power system, development of advanced protection algorithms for numerical relays and power system simulations. Zoran is holder of four patents.

Fahrudin Mekić was born in former Yugoslavia in 1967. He received his BSEE with honors from Sarajevo University, Bosnia and Herzegovina in 1991 where he also worked as research assistant. He received his MSEE degree from Istanbul Technical University, Turkey in 1996. Since 1996 he has been working in the area of power system protection and control within ABB, where he had various engineering positions. Currently he is Global Product Manager with the Distribution Automation, ABB Inc, in Allentown, PA. Fahrudin has published several technical papers in the area of protection and reliability. He is currently responsible for the application and technical issues associated with ABB relays. He is a senior member of IEEE.