

DUAL DIMENSIONS INCHES (ESTIMATING ONLY)
[MILLIMETERS]

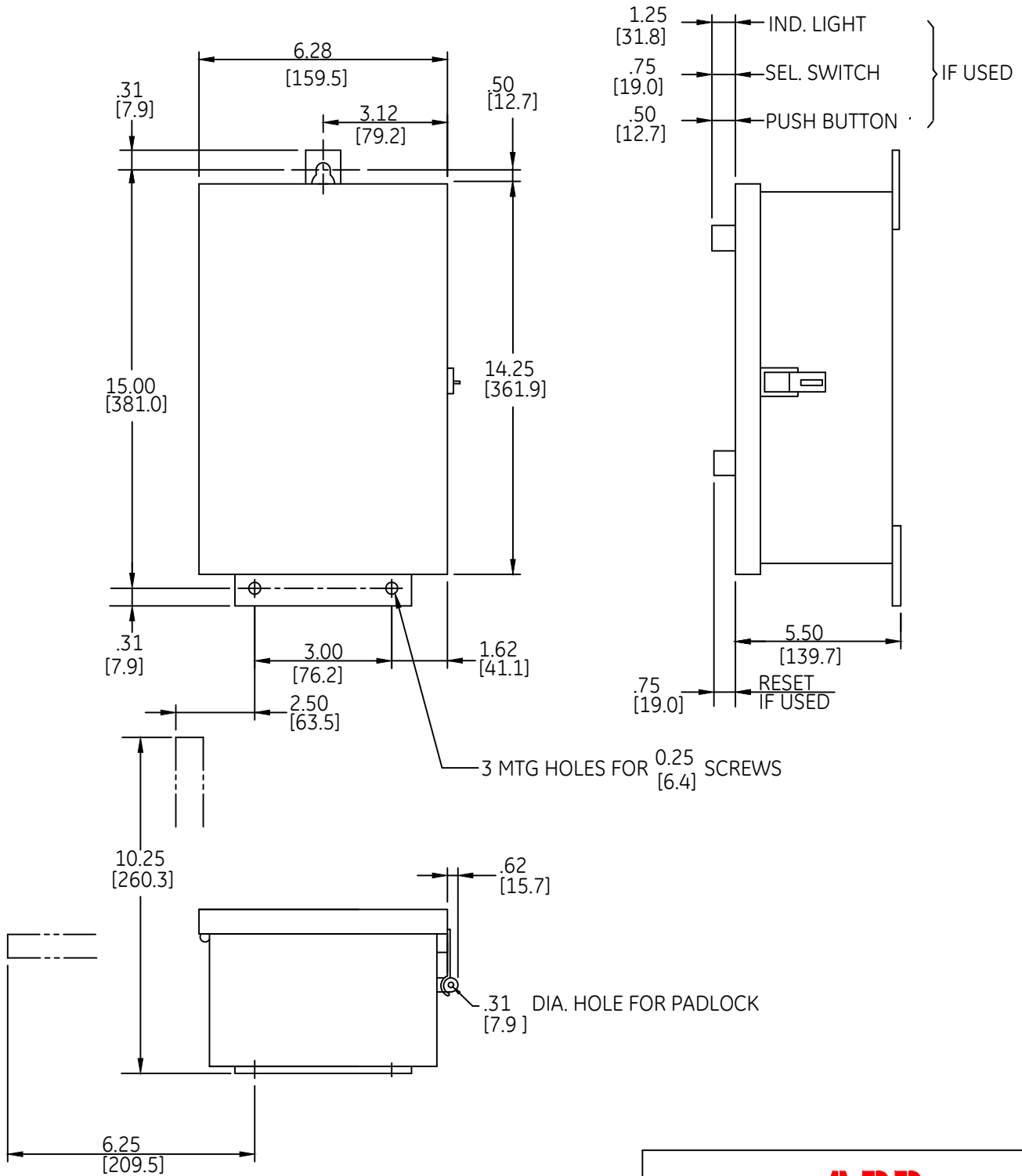

OUTLINE
TYPE 12 ENCLOSED

THIRD ANGLE	SHEET#	DWG NO.	DATE	REV
	1 of 1	55-184777	03/21	05