ABB INDUSTRIAL DRIVES

ACS880...+C132 marine type-approved cabinet-built drives and units

Supplement



ACS880...+C132 marine type-approved cabinet-built drives and units

Supplement

Table of contents



Table of contents

1 Introduction to the supplement

Contents of this chapter	9
Applicability	9
Target audience	9
Related manuals	10

1 ACS880-07...+C132

Contents of this chapter	11
Product overview	11
Mechanical installation	11
Electrical installation	11
Technical data	12
Ratings	12
Definitions	15
Ambient temperature (surrounding air) derating	16
Applicable standards	16
Marine type approvals	16

2 ACS880-17 and ACS880-37...+C132

Contents of this chapter	17
Product overview	17
Mechanical installation	17
Electrical installation	17
Technical data	18
Ratings R11	18
Ratings n×R8i	19
Definitions	20
Ambient temperature (surrounding air) derating	21
Applicable standards	21
Marine type approvals	21

3 ACS880-107...+C132

Contents of this chapter	23
Product overview	23
Mechanical installation	23
Electrical installation	23
Technical data	24
Ratings	24
Definitions	26
Ambient temperature (surrounding air) derating	27
Applicable standards	27
Marine type approvals	27



4 ACS880-207...+C132

Contents of this chapter 29
 Product overview 29
 Mechanical installation 29
 Electrical installation 29
 Technical data 30
 Ratings 30
 Definitions 31
 Ambient temperature (surrounding air) derating 32
 Applicable standards 32
 Marine type approvals 32

5 ACS880-307...+A018 +C132

Contents of this chapter 33
 Product overview 33
 Mechanical installation 33
 Electrical installation 33
 Technical data 34
 Ratings 34
 Definitions 36
 Ambient temperature (surrounding air) derating 36
 Applicable standards 37
 Marine type approvals 37

6 ACS880-607...+C132, 1-phase

Contents of this chapter 39
 Product overview 39
 Mechanical installation 39
 Electrical installation 39
 Technical data 40
 Ratings 40
 Definitions 42
 Applicable standards 43
 Marine type approvals 43

7 ACS880-607...+C132, 3-phase

Contents of this chapter 45
 Product overview 45
 Mechanical installation 45
 Electrical installation 45
 Technical data 46
 Ratings 46
 Definitions 48
 Ambient temperature (surrounding air) derating 49
 Applicable standards 49
 Marine type approvals 50

8 ACS880-1607...+C132

Contents of this chapter 51
 Product overview 51



Mechanical installation	51
Electrical installation	51
Technical data	52
Ratings	52
Definitions	53
Ambient temperature (surrounding air) derating	54
Applicable standards	55
Marine type approvals	55

Further information



1

Introduction to the supplement

Contents of this chapter

This chapter describes the supplement.

Applicability

The supplement contains ratings at an ambient temperature of 45 °C (113 °F) and references to valid marine type approval certificates on the following marine type approved drives:

- ACS880-07 (frames R6...R11 and n×R8i)
- ACS880-17/37 (frames R11 and n×R8i)
- ACS880-107 (frames R5i...n×R8i)
- ACS880-207 (frames R6i and n×R8i)
- ACS880-307 (frames 2×D7T and n×D87)
- ACS880-607 (module types NBRA-658 and NBRA-659)
- ACS880-607 (frames R8i and n×R8i)
- ACS880-1607 (frames R8i and n×R8i).

Target audience

This manual is intended for people who plan the installation, install, commission and do maintenance work on the drive, or create instructions for the end user of the drive concerning the installation and maintenance of the drive.

Read the manual before you work on the drive. You are expected to know the fundamentals of electricity, wiring, electrical components and electrical schematic symbols.

Related manuals

General manuals	Code (English)
Safety instructions for ACS880 multidrive cabinets and modules	3AUA0000102301
Electrical planning instructions for ACS880 multidrive cabinets and modules	3AUA0000102324
Cabinet design and construction instructions for ACS880 multidrive modules	3AUA0000107668

Drive hardware manuals and guides	Code (English)
ACS880-07 drives (45 to 710 kW, 50 to 700 hp) hardware manual	3AUA0000105718
ACS880-07 drives (560 to 2800 kW) hardware manual	3AUA0000143261
ACS880-17 drives (45 to 400 kW) hardware manual	3AXD50000035158
ACS880-17 drives (160 to 3200 kW) hardware manual	3AXD50000020436
ACS880-37 drives (45 to 400 kW) hardware manual	3AXD50000035159
ACS880-37 drives (160 to 3200 kW) hardware manual	3AXD50000020437
ACS880-107 inverter units hardware manual	3AUA0000102519
ACS880-207 IGBT supply units hardware manual	3AUA0000130644
ACS880-307 +A018 diode supply units hardware manual	3AXD50000011408
ACS880-607 1-phase brake units hardware manual	3AUA0000102559
ACS880-607 3-phase brake units hardware manual	3AXD50000022034
ACS880-1607 DC/DC converter units hardware manual	3AXD50000023644

Drive firmware manuals and guides	Code (English)
ACS880 primary control program firmware manual	3AUA0000085967
ACS880 primary control program quick start-up guide	3AUA0000098062
ACS880 IGBT supply control program firmware manual	3AUA0000131562
ACS880 diode supply control program firmware manual	3AUA0000103295
ACS880 brake control program firmware manual	3AXD50000020967
ACS880 DC/DC converter control program firmware manual	3AXD50000024671

Option manuals and guides
Manuals and quick guides for I/O extension modules, fieldbus adapters, etc.

You can find manuals and other product documents in PDF format on the Internet. See section Document library on the Internet on the inside of the back cover. For manuals not available in the Document library, contact your local ABB representative.

1

ACS880-07...+C132

Contents of this chapter

This chapter contains an overview and the ratings for the ACS880-07...+C132.

Product overview

The ACS880-07...+C132 is a marine type-approved cabinet-built drive.

Mechanical installation

Obey the instructions in the hardware manual.

Electrical installation

Obey the instructions in the hardware manual.

Technical data

■ Ratings

ACS880-07-...	Frame	No-overload use					Light over-load use		Heavy-duty use	
		I_1	I_2	I_{max}	P_N	S_N	I_{Ld}	P_{Ld}	I_{Hd}	P_{Hd}
		A(AC)	A(AC)	A(AC)	kW	kVA	A	kW	A	kW
$U_N = 400 \text{ V (Range 380 ... 415 V)}$										
6-pulse										
0105A-3	R6	100	100	141	52	69	95	52	83	43
0145A-3	R6	138	138	169	71	95	131	71	100	52
0169A-3	R7	161	161	234	86	111	153	86	138	71
0206A-3	R7	196	196	273	105	136	186	105	161	86
0246A-3	R8	234	234	333	125	162	222	125	196	105
0293A-3	R8	278	278	397	152	193	264	152	234 ¹	125
0363A-3	R9	345	345	473	190	239	328	190	278	152
0430A-3	R9	409	409	517	238	283	380	190	345 ²	190
0505A-3	R10	480	480	532	238	332	461	238	343	190
0585A-3	R10	556	556	694	299	385	564	299	408	238
0650A-3	R10	618	618	694	337	428	602	337	453	238
0725A-3	R11	689	689	969	380	477	679	380	538	299
0820A-3	R11	779	779	969	428	540	770	428	594	337
0880A-3	R11	836	836	1045	475	579	822	475	689 ³	380
1140A-3	1×D8T + 2×R8i	995	1083	1408	599	750	1018	532	747	428
1250A-3	2×D8T + 2×R8i	1093	1190	1550	675	824	1142	599	890	475
1480A-3	2×D8T + 2×R8i	1295	1410	1840	760	977	1354	760	1055	599
1760A-3	2×D8T + 2×R8i	1534	1670	2010	950	1157	1603	855	1249	675
2210A-3	3×D8T + 3×R8i	1929	2100	2730	1140	1455	2016	1140	1571	855
2610A-3	3×D8T + 3×R8i	2278	2480	2980	1330	1718	2381	1330	1855	950
12-pulse										
0990A-3+A004	2×D7T + 2×R8i	863	940	1222	532	651	902	475	703	380
1140A-3+A004	2×D8T + 2×R8i	995	1083	1408	599	750	1040	532	810	428
1250A-3+A004	2×D8T + 2×R8i	1093	1190	1550	675	824	1142	599	890	475
1480A-3+A004	2×D8T + 2×R8i	1295	1410	1840	760	977	1354	760	1055	599
1760A-3+A004	2×D8T + 2×R8i	1534	1670	2010	950	1157	1603	855	1249	675

ACS880-07-...	Frame	No-overload use					Light over-load use		Heavy-duty use	
		I_1	I_2	I_{max}	P_N	S_N	I_{Ld}	P_{Ld}	I_{Hd}	P_{Hd}
		A(AC)	A(AC)	A(AC)	kW	kVA	A	kW	A	kW
2210A-3+A004	4×D8T + 3×R8i	1929	2100	2730	1140	1455	2016	1140	1571	855
2610A-3+A004	4×D8T + 3×R8i	2278	2480	2980	1330	1718	2381	1330	1855	950
$U_N = 500 \text{ V (Range 380 ... 500 V)}$										
6-pulse										
0096A-5	R6	91	91	141	52	79	86	52	73	43
0124A-5	R6	118	118	169	71	102	112	71	91	52
0156A-5	R7	148	148	234	86	128	141	86	118	71
0180A-5	R7	171	171	273	105	148	162	105	148	86
0240A-5	R8	228	228	333	125	197	217	125	171	105
0260A-5	R8	247	247	397	152	214	235	152	228 ⁵	125
0361A-5	R9	343	343	515	190	297	326	190	287	190
0414A-5	R9	393	393	514	238	341	373	238	343 ²	190
0460A-5	R10	437	437	532	299	378	428	299	314	190
0503A-5	R10	478	478	532	337	414	459	299	343	238
0583A-5	R10	554	554	694	380	480	544	380	393	238
0635A-5	R10	603	603	694	428	522	592	428	453	299
0715A-5	R11	679	679	808	475	588	670	475	538	380
0820A-5	R11	779	779	969	532	675	767	532	594	428
0880A-5	R11	836	836	1045	599	724	814	532	662 ⁵	475
1070A-5	1×D8T + 2×R8i	928	1010	1313	675	875	970	675	755	532
1320A-5	2×D8T + 2×R8i	1157	1260	1638	855	1091	1210	855	942	675
1450A-5	2×D8T + 2×R8i	1258	1370	1790	950	1186	1315	855	1025	675
1580A-5	2×D8T + 2×R8i	1378	1500	1950	1045	1299	1440	950	1122	760
1800A-5	2×D8T + 3×R8i	1571	1710	2223	1188	1481	1642	1140	1279	855
1980A-5	2×D8T + 3×R8i	1727	1880	2444	1330	1628	1805	1235	1406	950
12-pulse										
0990A-5+A004	2×D7T + 2×R8i	863	940	1222	675	814	902	599	703	475
1320A-5+A004	2×D8T + 2×R8i	1157	1260	1638	855	1091	1210	855	942	675
1450A-5+A004	2×D8T + 2×R8i	1258	1370	1790	950	1186	1315	855	1025	675
1580A-5+A004	2×D8T + 2×R8i	1378	1500	1950	1045	1299	1440	950	1122	760
1800A-5+A004	2×D8T + 3×R8i	1571	1710	2223	1188	1481	1642	1140	1279	855

14 ACS880-07...+C132

ACS880-07-...	Frame	No-overload use					Light over-load use		Heavy-duty use	
		I_1	I_2	I_{max}	P_N	S_N	I_{Ld}	P_{Ld}	I_{Hd}	P_{Hd}
		A(AC)	A(AC)	A(AC)	kW	kVA	A	kW	A	kW
1980A-5+A004	2×D8T + 3×R8i	1727	1880	2444	1330	1628	1805	1235	1406	950
$U_N = 690$ V (Range 525...690 V)										
6-pulse										
0061A-7	R6	58	58	99	52	62	55	52	47	43
0084A-7	R6	80	80	118	71	85	76	71	58	52
0098A-7	R7	93	93	160	86	102	88	86	80	71
0119A-7	R7	113	113	188	105	125	107	105	93	86
0142A-7	R8	135	135	238	125	150	128	125	113	105
0174A-7	R8	165	165	260	152	182	157	152	135	125
0210A-7	R9	200	200	365	190	227	190	190	165	152
0271A-7	R9	257	257	391	238	284	245	238	200	190
0330A-7	R10	314	314	456	299	358	304	299	242	238
0370A-7	R10	352	352	494	337	403	342	337	309	299
0430A-7	R10	409	409	494	380	454	394	380	342 ³	337
0470A-7	R11	447	447	622	428	511	432	428	394	380
0522A-7	R11	496	496	622	475	568	480	475	432	428
0590A-7	R11	561	561	760	532	636	542	532	480	475
0650A-7	R11	618	618	779	599	715	599	599	542 ⁴	532
0721A-7	R11	685	685	779	675	806	670	599	542 ⁴	532
0800A-7	1×D8T + 2×R8i	698	760	1140	760	908	730	675	568	532
0900A-7	1×D8T + 2×R8i	785	855	1283	855	1022	821	760	640	599
1160A-7	2×D8T + 2×R8i	1010	1100	1650	1045	1315	1056	1045	823	760
1450A-7	2×D8T + 3×R8i	1265	1378	2066	1330	1646	1322	1188	1030	950
1650A-7	2×D8T + 3×R8i	1442	1570	2355	1520	1876	1507	1425	1174	1140
1950A-7	3×D8T + 4×R8i	1702	1853	2779	1805	2214	1778	1710	1386	1330
2300A-7	3×D8T + 4×R8i	2002	2180	3270	2090	2605	2093	1900	1631	1520
2600A-7	4×D8T + 5×R8i	2269	2470	3705	2375	2952	2371	2280	1848	1805
2860A-7	4×D8T + 5×R8i	2498	2720	4080	2660	3251	2611	2470	2035	1900
12-pulse										
0800A-7+A004	2×D7T + 2×R8i	698	760	1140	760	908	730	675	568	532
0950A-7+A004	2×D8T + 2×R8i	829	903	1354	855	1079	866	760	675	599

ACS880-07-...	Frame	No-overload use					Light over-load use		Heavy-duty use	
		I_1	I_2	I_{max}	P_N	S_N	I_{Ld}	P_{Ld}	I_{Hd}	P_{Hd}
		A(AC)	A(AC)	A(AC)	kW	kVA	A	kW	A	kW
1160A-7+A004	2×D8T + 2×R8i	1010	1100	1650	1045	1315	1056	1045	823	760
1450A-7+A004	2×D8T + 3×R8i	1265	1378	2066	1330	1646	1322	1188	1030	950
1650A-7+A004	2×D8T + 3×R8i	1442	1570	2355	1520	1876	1507	1425	1174	1140
1950A-7+A004	4×D8T + 4×R8i	1702	1853	2779	1805	2214	1778	1710	1386	1330
2300A-7+A004	4×D8T + 4×R8i	2002	2180	3270	2090	2605	2093	1900	1631	1520
2600A-7+A004	4×D8T + 5×R8i	2269	2470	3705	2375	2952	2371	2280	1848	1805
2860A-7+A004	4×D8T + 5×R8i	2498	2720	4080	2660	3251	2611	2280	2035	1900
3AXD10000501309										

Definitions

Nominal ratings	
U_N	Nominal voltage
I_1	Nominal rms input current
I_2	Nominal output current (available continuously with no over-loading)
I_{max}	Maximum output current. Available for 10 s at start, otherwise as long as allowed by drive temperature.
P_N	Nominal output power
S_N	Apparent power in no-overload use
Light-overload use (10% overload capability) ratings	
I_{Ld}	Continuous rms output current. 10% overload is allowed for one minute every 5 minutes.
P_{Ld}	Output power in light-overload use
Heavy-duty use (50% overload capability) ratings	
I_{Hd}	Continuous rms output current. 50% overload is allowed for one minute every 5 minutes.
	¹ 130% overload
	² 125% overload
	³ 140% overload
	⁴ 144% overload
	⁵ 145% overload
P_{Hd}	Output power in heavy-duty use

Note 1: The ratings apply at an ambient temperature of 45 °C (113 °F).

Note 2: To achieve the rated motor power given in the table, the rated current of the drive must be higher than or equal to the rated motor current.

The DriveSize dimensioning tool available from ABB is recommended for selecting the drive, motor and gear combination.

Ambient temperature (surrounding air) derating

In the temperature range +45...50 °C (+113...122 °F), the rated output current is derated by 1% for every added 1 °C (1.8 °F) as follows.

To calculate the output current, multiply the current in the ratings table by the derating factor (k).

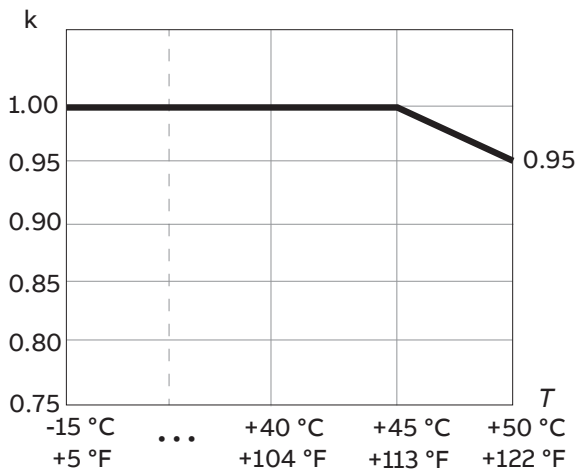

Applicable standards

See the hardware manual.

Marine type approvals

You can find the ACS880-07...+C132 marine type approval certificates on the Internet. Go to www.abb.com/drives/documents. Browse or enter selection criteria in the search field.



ACS880-17 and ACS880-37...+C132

Contents of this chapter

This chapter contains an overview and the ratings for the ACS880-17...+C132 and ACS880-37...+C132.

Product overview

The ACS880-17...+C132 and ACS880-37...+C132 are marine type-approved cabinet-built drives.

Mechanical installation

Obey the instructions in the hardware manual.

Electrical installation

Obey the instructions in the hardware manual.

Technical data

■ Ratings R11

ACS880-17/37-...	Frame	No-overload use					Light-overload use		Heavy-duty use	
		I_1	I_2	I_{max}	P_N	S_N	I_{Ld}	P_{Ld}	I_{Hd}	P_{Hd}
		A	A	A	kW	kVA	A	kW	A	kW
U _N = 400 V (Range 380 ... 415 V)										
0293A-3	R11	244	278	397	152	193	264	152	234	125
0363A-3	R11	305	345	473	190	239	328	190	278	152
0442A-3	R11	381	420	518	238	291	399	238	345	190
0505A-3	R11	381	480	532	238	332	456	238	345	190
0585A-3	R11	480	556	694	299	385	528	299	420	238
0650A-3	R11	541	618	694	337	428	587	337	480	238
U _N = 500 V (Range 380 ... 500 V)										
0260A-5	R11	195	247	397	152	214	235	152	228	125
0361A-5	R11	244	343	515	190	297	326	190	247	152
0414A-5	R11	305	393	515	238	341	373	238	343	190
0460A-5	R11	384	437	532	299	378	428	299	393	238
0503A-5	R11	432	478	532	337	414	467	337	437	299
U _N = 690 V (Range 660 ... 690 V)										
0174A-7	R11	142	165	260	152	198	157	152	135	125
0210A-7	R11	177	200	365	190	238	190	190	165	152
0271A-7	R11	220	257	390	238	308	244	238	200	190
0330A-7	R11	278	314	456	299	375	304	299	257	238
0370A-7	R11	314	352	494	337	420	342	337	314	299
0430A-7	R11	356	409	494	380	488	399	380	352	337
3AXD10000425795										

■ Ratings n×R8i

ACS880-17/37-...	Frame	No-overload use					Light-overload use		Heavy-duty use	
		I_1	I_2	I_{max}	P_N	S_N	I_{Ld}	P_{Ld}	I_{Hd}	P_{Hd}
		A	A	A	kW	kVA	A	kW	A	kW
$U_N = 400 \text{ V (Range 380 ... 415 V)}$										
0450A-3	1×R8i + 1×R8i	399	430	560	238	298	413	190	322	152
0620A-3	1×R8i + 1×R8i	538	580	760	337	402	557	299	434	238
0730A-3	1×R8i + 1×R8i	649	700	910	380	485	672	337	524	238
0800A-3	1×R8i + 1×R8i	705	760	990	428	527	730	380	568	299
0870A-3	1×R8i + 1×R8i	761	820	1070	475	568	787	428	613	337
1110A-5	2×R8i + 2×R8i	978	1055	1380	599	731	1012	532	789	428
1210A-3	2×R8i + 2×R8i	1067	1150	1500	675	797	1104	599	860	475
1430A-3	2×R8i + 2×R8i	1262	1360	1770	760	942	1306	675	1017	532
1700A-3	2×R8i + 2×R8i	1494	1610	2100	950	1115	1546	855	1204	675
2060A-3	3×R8i + 3×R8i	1816	1957	2550	1140	1356	1879	1045	1464	760
2530A-3	3×R8i + 3×R8i	2227	2400	3120	1330	1663	2304	1140	1795	950
$U_N = 500 \text{ V (Range 380 ... 500 V)}$										
0420A-5	1×R8i + 1×R8i	371	400	520	238	346	384	238	299	190
0570A-5	1×R8i + 1×R8i	501	540	710	380	468	518	337	404	238
0640A-5	1×R8i + 1×R8i	566	610	800	428	528	586	380	456	299
0710A-5	1×R8i + 1×R8i	631	680	890	475	589	653	428	509	337
0780A-5	1×R8i + 1×R8i	687	740	970	532	641	710	475	554	380
1010A-5	2×R8i + 2×R8i	890	960	1250	675	831	921	599	718	475
1110A-5	2×R8i + 2×R8i	974	1050	1370	760	909	1008	675	785	532
1530A-5	2×R8i + 2×R8i	1345	1450	1890	1045	1256	1392	950	1085	760
1980A-5	3×R8i + 3×R8i	1745	1881	2450	1330	1629	1806	1235	1407	950
2270A-5	3×R8i + 3×R8i	2004	2160	2810	1520	1871	2074	1425	1616	1140
$U_N = 690 \text{ V (Range 525 ... 690 V)}$										
0320A-7	1×R8i + 1×R8i	288	310	470	299	370	298	238	232	190
0390A-7	1×R8i + 1×R8i	343	370	560	337	442	355	337	277	238
0460A-7	1×R8i + 1×R8i	408	440	660	428	526	422	380	329	299
0510A-7	1×R8i + 1×R8i	445	480	720	475	574	461	428	359	337
0580A-7	1×R8i + 1×R8i	510	550	830	532	657	528	475	411	380

ACS880-17/37-...	Frame	No-overload use					Light-overload use		Heavy-duty use	
		I_1	I_2	I_{max}	P_N	S_N	I_{Ld}	P_{Ld}	I_{Hd}	P_{Hd}
		A	A	A	kW	kVA	A	kW	A	kW
0660A-7	2×R8i + 2×R8i	582	627	950	599	749	602	532	469	428
0770A-7	2×R8i + 2×R8i	677	730	1100	675	872	701	675	546	532
0950A-7	2×R8i + 2×R8i	837	903	1360	855	1079	866	760	675	675
1130A-7	2×R8i + 2×R8i	993	1070	1610	1045	1279	1027	950	800	760
1450A-7	3×R8i + 3×R8i	1278	1378	2070	1330	1646	1322	1235	1030	950
1680A-7	3×R8i + 3×R8i	1485	1600	2400	1520	1912	1536	1425	1197	1140
1950A-7	4×R8i + 4×R8i	1719	1853	2780	1805	2214	1778	1710	1386	1330
2230A-7	4×R8i + 4×R8i	1958	2110	3170	2090	2522	2026	1900	1578	1520
2770A-7	6×R8i + 5×R8i	2440	2630	3950	2565	3143	2525	2470	1967	1900
3310A-7	6×R8i + 6×R8i	2913	3140	4710	3040	3753	3014	2850	2349	2280
3AXD10000501309										

Definitions

Nominal ratings	
I_2	Nominal output current (available continuously with no over-loading)
I_{max}	Maximum output current. Available for 10 s at start, otherwise as long as allowed by drive temperature.
P_N	Nominal output power
Light-overload use (10% overload capability) ratings	
I_{Ld}	Continuous rms output current. 10% overload is allowed for one minute every 5 minutes.
P_{Ld}	Output power in light-overload use
Heavy-duty use (50% overload capability) ratings	
I_{Hd}	Continuous rms output current. 50% overload is allowed for one minute every 5 minutes.
P_{Hd}	Output power in heavy-duty use

Note 1: The ratings apply at an ambient temperature of 45 °C (113 °F).

Note 2: To achieve the rated motor power given in the table, the rated current of the drive must be higher than or equal to the rated motor current.

The DriveSize dimensioning tool available from ABB is recommended for selecting the drive, motor and gear combination.

Ambient temperature (surrounding air) derating

In the temperature range +45...50 °C (+113...122 °F), the rated output current is derated by 1% for every added 1 °C (1.8 °F) as follows.

To calculate the output current, multiply the current in the ratings table by the derating factor (k).

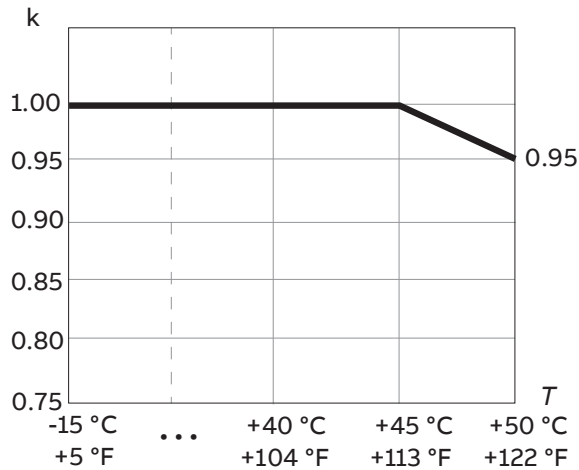

Applicable standards

See the hardware manual.

Marine type approvals

You can find the ACS880-17/37...+C132 marine type approval certificates on the Internet. Go to www.abb.com/drives/documents. Browse or enter selection criteria in the search field.

3

ACS880-107...+C132

Contents of this chapter

This chapter contains an overview and the ratings for the ACS880-107...+C132.

Product overview

The ACS880-107...+C132 is a marine type-approved cabinet-built inverter unit.

Mechanical installation

Obey the instructions in Mechanical installation instructions for ACS880 multidrive cabinets (3AUA0000101764 [English]) and the hardware manual.

Electrical installation

Obey the instructions in Electrical planning instructions for ACS880 multidrive cabinets and modules (3AUA0000102324 [English]) and the hardware manual.

Technical data

■ Ratings

Inverter unit type ACS880-107- ...	Frame size	Input current	Output ratings							
			No-overload use				Light-overload use		Heavy-duty use	
		I_1	I_{max}	I_2	P_N	S_N	I_{Ld}	P_{Ld}	I_{Hd}	P_{Hd}
		A (DC)	A (AC)	A (AC)	kW	kVA	A (AC)	kW	A (AC)	kW
U _N = 400 V										
0140A-3	R6i	161	174	134	71	93	129	71	100	52
0170A-3	R6i	193	209	161	86	112	155	86	120	52
0210A-3	R6i	235	255	196	105	136	188	105	147	71
0250A-3	R6i	281	304	234	125	162	225	125	175	86
0300A-3	R7i	342	371	285	152	197	274	152	213	105
0350A-3	R7i	399	432	333	190	230	319	152	249	125
0470A-3	R8i	502	590	447	238	309	429	238	334	152
0640A-3	R8i	684	800	608	337	421	584	299	455	238
0760A-3	R8i	812	940	722	380	500	693	380	540	299
0830A-3	R8i	887	1030	789	428	546	757	380	590	299
0900A-3	R8i	962	1030	855	475	592	821	428	640	337
1250A-3	2×R8i	1339	1550	1190	675	824	1142	599	890	475
1480A-3	2×R8i	1586	1840	1410	760	977	1354	760	1055	599
1760A-3	2×R8i	1879	2010	1670	950	1157	1603	855	1249	675
2210A-3	3×R8i	2363	2730	2100	1140	1455	2016	1140	1571	855
2610A-3	3×R8i	2790	2980	2480	1330	1718	2381	1330	1855	950
3450A-3	4×R8i	3690	3940	3280	1710	2272	3149	1710	2453	1330
4290A-3	5×R8i	4590	4900	4080	2280	2827	3917	1900	3052	1710
5130A-3	6×R8i	5479	5850	4870	2660	3374	4675	2280	3643	1900
U _N = 500 V										
0110A-5	R6i	130	140	108	71	94	104	71	81	52
0140A-5	R6i	155	168	129	86	112	124	86	96	52
0170A-5	R6i	188	204	157	105	136	151	105	117	71
0200A-5	R6i	226	244	187	125	162	180	125	141	86
0240A-5	R6i	274	296	228	152	197	219	152	171	105
0300A-5	R7i	344	373	287	190	249	276	190	215	125

Inverter unit type ACS880-107- ...	Frame size	Input current	Output ratings								
			No-overload use				Light-overload use		Heavy-duty use		
			I_1	I_{max}	I_2	P_N	S_N	I_{Ld}	P_{Ld}	I_{Hd}	P_{Hd}
			A (DC)	A (AC)	A (AC)	kW	kVA	A (AC)	kW	A (AC)	kW
0340A-5	R7i	388	420	323	238	280	310	190	242	152	
0440A-5	R8i	470	550	418	238	362	401	238	313	190	
0590A-5	R8i	631	730	561	380	485	538	337	419	238	
0670A-5	R8i	716	830	637	428	551	611	380	476	299	
0740A-5	R8i	791	920	703	475	609	675	428	526	337	
0810A-5	R8i	866	1010	770	532	666	739	475	576	380	
1150A-5	2×R8i	1226	1420	1090	760	944	1046	675	815	532	
1450A-5	2×R8i	1541	1790	1370	950	1186	1315	855	1025	675	
1580A-5	2×R8i	1688	1950	1500	1045	1299	1440	950	1122	760	
2150A-5	3×R8i	2295	2660	2040	1425	1767	1958	1330	1526	1045	
2350A-5	3×R8i	2509	2900	2230	1520	1931	2141	1425	1668	1140	
3110A-5	4×R8i	3319	3840	2950	1900	2555	2832	1900	2207	1520	
3860A-5	5×R8i	4129	4780	3670	2280	3178	3523	2280	2745	1900	
4610A-5	6×R8i	4928	5700	4380	3040	3793	4205	2660	3276	2280	
$U_N = 690 V$											
007A3-7	R5i	8	9.0	6.9	5.2	8.3	6.6	5.2	5.3	3.8	
009A8-7	R5i	11	12.1	9.3	7.1	11.1	8.8	7.1	6.9	5.2	
014A2-7	R5i	16	17.5	13.5	10.5	16.1	12.8	10.5	9.3	7.1	
0018A-7	R5i	21	22.2	17.1	14.3	20.4	16.2	14.3	13.5	10.5	
0022A-7	R5i	25	27	21	17.6	25.1	19.9	17.6	17.1	14.3	
0027A-7	R5i	31	33	26	20.9	30.7	24.4	20.9	20.9	17.6	
0035A-7	R5i	40	43	33	28.5	39.7	31.6	28.5	25.7	20.9	
0042A-7	R5i	48	52	40	35.2	47.7	37.9	35.2	33.3	28.5	
0052A-7	R5i	59	64	49	42.8	59.0	46.9	42.8	39.9	35.2	
0062A-7	R6i	71	77	59	52	71	57	52	44	43	
0082A-7	R6i	94	101	78	71	93	75	71	58	52	
0100A-7	R6i	114	124	95	86	114	91	86	71	71	
0130A-7	R6i	143	155	119	105	142	114	105	89	71	
0140A-7	R6i	164	178	137	125	164	132	125	102	86	
0190A-7	R6i	220	238	183	152	219	176	152	137	125	

Inverter unit type ACS880-107- ...	Frame size	Input current	Output ratings								
			No-overload use				Light-overload use		Heavy-duty use		
			I_1	I_{max}	I_2	P_N	S_N	I_{Ld}	P_{Ld}	I_{Hd}	P_{Hd}
			A (DC)	A (AC)	A (AC)	kW	kVA	A (AC)	kW	A (AC)	kW
0220A-7	R7i	248	269	206	190	247	198	190	155	152	
0270A-7	R7i	308	334	257	238	307	247	238	192	190	
0340A-7	R8i	363	490	323	299	386	310	238	242	190	
0410A-7	R8i	438	590	390	380	465	374	337	291	238	
0480A-7	R8i	513	690	456	428	545	438	380	341	299	
0530A-7	R8i	566	760	504	475	602	483	428	377	337	
0600A-7	R8i	641	860	570	532	681	547	532	426	380	
0800A-7	2×R8i	855	1140	760	760	908	730	675	568	532	
1030A-7	2×R8i	1103	1470	980	950	1171	941	855	733	675	
1170A-7	2×R8i	1249	1670	1110	1045	1327	1066	950	830	760	
1540A-7	3×R8i	1643	2190	1460	1330	1745	1402	1330	1092	1045	
1740A-7	3×R8i	1856	2480	1650	1520	1972	1584	1520	1234	1140	
2300A-7	4×R8i	2453	3270	2180	1900	2605	2093	1900	1631	1520	
2860A-7	5×R8i	3060	4080	2720	2660	3251	2611	2280	2035	1900	
3420A-7	6×R8i	3645	4860	3240	3040	3872	3110	3040	2424	2280	
3990A-7	7×R8i	4264	5690	3790	3420	4529	3638	3420	2835	2660	
4560A-7	8×R8i	4871	6500	4330	4180	5175	4157	3800	3239	3040	
5130A-7	9×R8i	5479	7310	4870	4560	5820	4675	4560	3643	3420	
5700A-7	10×R8i	6086	8120	5410	5320	6466	5194	4940	4047	3800	
3AXD10000501309											

Definitions

U_N	Nominal voltage
I_1	Nominal rms input current
I_2	Nominal output current (available continuously with no over-loading)
I_{max}	Maximum output current. Available for 10 seconds at start; otherwise as long as allowed by drive temperature.
P_N	Typical motor power in no-overload use
S_N	Apparent power in no-overload use
I_{Ld}	Continuous rms output current allowing 110% overload for 1 minute every 5 minutes

P_{Ld}	Typical motor power in light-overload use
I_{Hd}	Continuous rms output current allowing 50% overload for 1 minute every 5 minutes
P_{Hd}	Typical motor power in heavy-duty use

Note 1: The ratings apply at an ambient temperature of 45 °C (113 °F).

Note 2: To achieve the rated motor power given in the table, the rated current of the drive must be higher than or equal to the rated motor current.

The DriveSize dimensioning tool available from ABB is recommended for selecting the drive, motor and gear combination.

Ambient temperature (surrounding air) derating

In the temperature range +45...50 °C (+113...122 °F), the rated output current is derated by 1% for every added 1 °C (1.8 °F) as follows.

To calculate the output current, multiply the current in the ratings table by the derating factor (k).

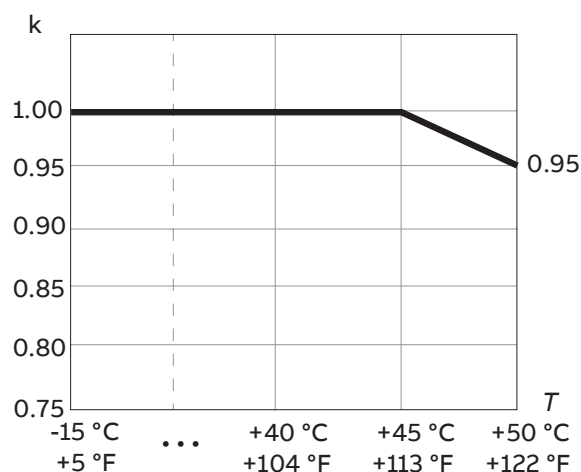

Applicable standards

See Electrical planning instructions for ACS880 multidrive cabinets and modules (3AUA0000102324 [English]).

Marine type approvals

You can find the ACS880-107...+C132 marine type approval certificates on the Internet. Go to www.abb.com/drives/documents. Browse or enter selection criteria in the search field.

4

ACS880-207...+C132

Contents of this chapter

This chapter contains an overview and the ratings for the ACS880-207...+C132.

Product overview

The ACS880-207...+C132 is a marine type-approved cabinet-installed IGBT supply unit.

Mechanical installation

Obey the instructions in Mechanical installation instructions for ACS880 multidrive cabinets (3AUA0000101764 [English]) and the hardware manual.

Electrical installation

Obey the instructions in Electrical planning instructions for ACS880 multidrive cabinets and modules (3AUA0000102324 [English]) and the hardware manual.

Technical data

■ Ratings

IGBT supply unit type ACS880-207-...	Frame	No-overload use					Light-overload use		Heavy-duty use	
		I_1	I_2	I_{max}	P_N	S_N	I_{Ld}	P_{Ld}	I_{Hd}	P_{Hd}
		A (AC)	A (DC)	A (DC)	kW	kVA	A (DC)	kW (DC)	A (DC)	kW (DC)
U _N = 400 V (Range 380 ... 415 V)										
0420A-3	1×R8i	402	487	633	276	278	468	265	364	206
0580A-3	1×R8i	547	663	863	375	379	637	360	496	281
0810A-3	1×R8i	770	933	1213	528	533	896	507	698	395
1130A-3	2×R8i	1071	1299	1688	735	742	1247	705	971	549
1330A-3	2×R8i	1269	1539	2000	870	879	1477	836	1151	651
1580A-3	2×R8i	1503	1822	2369	1031	1041	1749	990	1363	771
2350A-3	3×R8i	2232	2706	3518	1531	1546	2598	1470	2024	1145
3110A-3	4×R8i	2952	3579	4653	2025	2045	3436	1944	2677	1515
4620A-3	6×R8i	4383	5314	6909	3006	3037	5102	2886	3975	2249
U _N = 500 V (Range 380 ... 500 V)										
0400A-5	1×R8i	376	456	593	323	326	438	310	341	241
0530A-5	1×R8i	504	612	795	432	437	587	415	458	324
0730A-5	1×R8i	693	840	1092	594	600	806	570	628	444
1040A-5	2×R8i	981	1189	1546	841	850	1142	807	890	629
1420A-5	2×R8i	1350	1637	2128	1157	1169	1571	1111	1224	866
2120A-5	3×R8i	2007	2433	3164	1721	1738	2336	1652	1820	1287
2800A-5	4×R8i	2655	3219	4185	2276	2299	3090	2185	2408	1703
4150A-5	6×R8i	3942	4780	6214	3380	3414	4588	3245	3575	2528
U _N = 690 V (Range 525 ... 690 V)										
0310A-7	1×R8i	291	352	529	344	347	338	330	264	257
0370A-7	1×R8i	351	425	638	415	419	408	398	318	310
0540A-7	1×R8i	513	622	933	607	613	597	583	465	454
0720A-7	2×R8i	684	829	1244	809	817	796	777	620	605
1050A-7	2×R8i	999	1211	1817	1182	1194	1163	1135	906	884
1570A-7	3×R8i	1485	1801	2701	1757	1775	1729	1687	1347	1314
2070A-7	4×R8i	1962	2379	3568	2321	2345	2284	2229	1779	1736
3080A-7	6×R8i	2916	3536	5303	3450	3485	3394	3312	2645	2581

IGBT supply unit type ACS880-207-...	Frame	No-overload use					Light-overload use		Heavy-duty use	
		I_1	I_2	I_{max}	P_N	S_N	I_{Ld}	P_{Ld}	I_{Hd}	P_{Hd}
		A (AC)	A (DC)	A (DC)	kW	kVA	A (DC)	kW (DC)	A (DC)	kW (DC)
4100A-7	8×R8i	3897	4725	7088	4611	4657	4536	4426	3534	3449
5130A-7	10×R8i	4869	5904	8855	5761	5819	5668	5530	4416	4309
3AXD10000501309										

Definitions

Nominal ratings	
U_N	Nominal input voltage
I_1	Continuous rms input (AC) current. No overload capability at 45 °C (113 °F).
I_2	Continuous rms output (DC) current. No overload capability at 45 °C (113 °F).
I_{max}	Maximum output current. Available for 10 s at start, otherwise as long as allowed by drive temperature.
P_N	Nominal output power
S_N	Nominal apparent power
Light-overload use (10% overload capability) ratings	
I_{Ld}	Continuous rms output current. 10% overload is allowed for one minute every 5 minutes.
P_{Ld}	Output power in light-overload use
Heavy-duty use (50% overload capability) ratings	
I_{Hd}	Continuous rms output current. 50% overload is allowed for one minute every 5 minutes.
P_{Hd}	Output power in heavy-duty use

Note: The ratings apply at an ambient temperature of 45 °C (113 °F).

Ambient temperature (surrounding air) derating

In the temperature range +45...50 °C (+113...122 °F), the rated output current is derated by 1% for every added 1 °C (1.8 °F) as follows.

To calculate the output current, multiply the current in the ratings table by the derating factor (k).

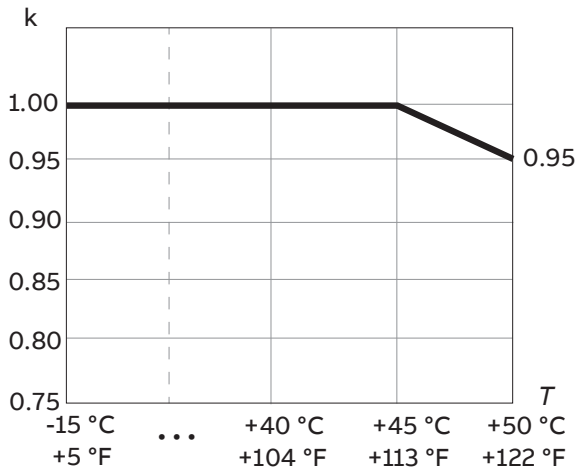

Applicable standards

See Electrical planning instructions for ACS880 multidrive cabinets and modules (3AUA0000102324 [English]).

Marine type approvals

You can find the ACS880-207...+C132 marine type approval certificates on the Internet. Go to www.abb.com/drives/documents. Browse or enter selection criteria in the search field.

5

ACS880-307...+A018 +C132

Contents of this chapter

This chapter contains an overview and the ratings for the ACS880-307...+A018 +C132.

Product overview

The ACS880-307...+A018 +C132 is a marine type-approved cabinet-installed diode supply unit.

Mechanical installation

Obey the instructions in Mechanical installation instructions for ACS880 multidrive cabinets (3AUA0000101764 [English]) and the hardware manual.

Electrical installation

Obey the instructions in Electrical planning instructions for ACS880 multidrive cabinets and modules (3AUA0000102324 [English]) and the hardware manual.

Technical data

■ Ratings

Diode supply unit type ACS880-307-...	Nominal ratings					Light overload use		Heavy-duty use	
	I_1	I_2	I_{max}	S_N	P_N	I_{Ld}	P_{Ld}	I_{Hd}	P_{Hd}
	A (AC)	A (DC)	A (DC)	kW	kVA	A (DC)	kW (DC)	A (DC)	kW (DC)
$U_N = 400\text{ V}$									
6-pulse									
0650A-3+A018	621	760	1064	430	410	730	394	568	307
0980A-3+A018	931	1140	1596	645	616	1094	591	853	460
1210A-3+A018	1155	1414	1980	800	764	1357	733	1058	571
1820A-3+A018	1731	2120	2968	1199	1145	2035	1099	1586	856
2730A-3+A018	2598	3181	4453	1800	1718	3054	1649	2379	1285
3640A-3+A018	3463	4241	5937	2399	2290	4071	2199	3172	1713
4560A-3+A018	4329	5301	7421	2999	2863	5089	2748	3965	2141
5470A-3+A018	5194	6361	8905	3599	3435	6107	3298	4758	2569
12-pulse									
1210A-3+A018	1155	1414	1980	800	764	1357	733	1058	571
1820A-3+A018	1731	2120	2968	1199	1145	2035	1099	1586	856
2730A-3+A018	2598	3181	4453	1800	1718	3054	1649	2379	1285
3640A-3+A018	3463	4241	5937	2399	2290	4071	2199	3172	1713
4560A-3+A018	4329	5301	7421	2999	2863	5089	2748	3965	2141
5470A-3+A018	5194	6361	8905	3599	3435	6107	3298	4758	2569
$U_N = 500\text{ V}$									
6-pulse									
0650A-5+A018	621	760	1064	538	513	730	492	568	384
0980A-5+A018	931	1140	1596	806	770	1094	739	853	576
1210A-5+A018	1155	1414	1980	1000	954	1357	916	1058	714
1820A-5+A018	1731	2120	2968	1499	1431	2035	1374	1586	1070
2730A-5+A018	2597	3181	4453	2249	2147	3054	2061	2379	1606
3640A-5+A018	3463	4241	5937	2999	2863	4071	2748	3172	2141
4560A-5+A018	4329	5301	7421	3749	3578	5089	3435	3965	2676
5470A-5+A018	5194	6361	8905	4498	4294	6107	4122	4758	3212

Diode supply unit type ACS880-307-...	Nominal ratings					Light overload use		Heavy-duty use	
	I_1	I_2	I_{max}	S_N	P_N	I_{Ld}	P_{Ld}	I_{Hd}	P_{Hd}
	A (AC)	A (DC)	A (DC)	kW	kVA	A (DC)	kW (DC)	A (DC)	kW (DC)
12-pulse									
0910A- 5+A004+A018	866	1060	1484	750	742	1018	712	793	555
1210A- 5+A004+A018	1155	1414	1980	1000	990	1357	950	1058	740
1820A- 5+A004+A018	1732	2120	2968	1499	1484	2035	1425	1586	1110
2430A- 5+A004+A018	2309	2827	3958	2000	1979	2714	1900	2115	1480
3640A- 5+A004+A018	3463	4241	5937	2999	2969	4071	2850	3172	2220
5470A- 5+A004+A018	5194	6361	8906	4498	4453	6107	4275	4758	3331
$U_N = 690 \text{ V}$									
6-pulse									
0570A-7+A018	543	665	931	649	619	638	595	497	463
0820A-7+A018	776	950	1330	927	885	912	850	711	662
1060A-7+A018	1011	1237	1732	1208	1152	1188	1106	925	862
1520A-7+A018	1443	1767	2474	1725	1646	1696	1580	1322	1231
2280A-7+A018	2165	2651	3711	2587	2469	2545	2371	1983	1847
3040A-7+A018	2886	3534	4948	3449	3292	3393	3160	2643	2462
3800A-7+A018	3608	4418	6185	4312	4115	4241	3951	3305	3078
4560A-7+A018	4329	5301	7421	5174	4938	5089	4740	3965	3694
12-pulse									
0760A- 7+A004+A018	722	884	1238	863	854	849	820	661	639
1060A- 7+A004+A018	1011	1237	1732	1208	1195	1188	1147	925	894
1520A- 7+A004+A018	1443	1767	2474	1725	1707	1696	1639	1322	1277
2130A- 7+A004+A018	2020	2474	3463	2414	2390	2375	2294	1850	1787
3040A- 7+A004+A018	2886	3534	4948	3449	3414	3393	3277	2643	2554
4560A- 7+A004+A018	4329	5301	7421	5174	5121	5089	4916	3965	3830

Diode supply unit type ACS880-307-...	Nominal ratings					Light overload use		Heavy-duty use	
	I_1	I_2	I_{max}	S_N	P_N	I_{Ld}	P_{Ld}	I_{Hd}	P_{Hd}
	A (AC)	A (DC)	A (DC)	kW	kVA	A (DC)	kW (DC)	A (DC)	kW (DC)
3AXD10000501309									

Definitions

Nominal ratings	
U_N	Nominal input voltage. For U_1 , see the hardware manual.
I_1	Continuous rms input (AC) current. No overload capability at 45 °C (113 °F).
I_2	Continuous output (DC) current. No overload capability at 45 °C (113 °F).
I_{max}	Maximum output current
P_N	Nominal output power
S_N	Nominal apparent power
Light-overload use (10% overload capability) ratings	
I_{Ld}	Continuous current. 10% overload is allowed for one minute every 5 minutes.
P_{Ld}	Output power in light-overload use
Heavy-duty use (40% overload capability) ratings	
I_{Hd}	Continuous current. 40% overload is allowed for one minute every 5 minutes.
P_{Hd}	Output power in heavy-duty use

Note: The ratings apply at an ambient temperature of 45 °C (113 °F).

Ambient temperature (surrounding air) derating

In the temperature range +45...50 °C (+113...122 °F), the rated output current is derated by 1% for every added 1 °C (1.8 °F) as follows.

To calculate the output current, multiply the current in the ratings table by the derating factor (k).

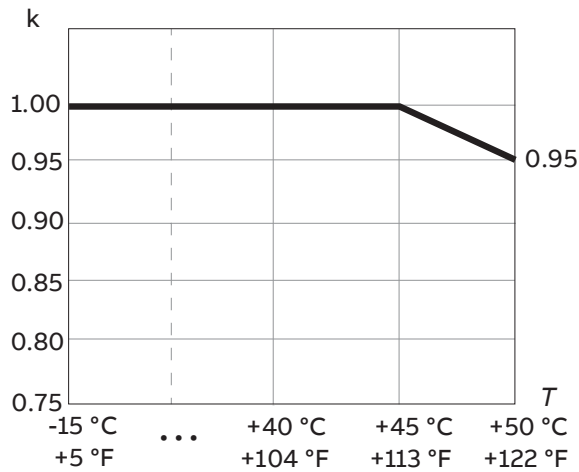

Applicable standards

See Electrical planning instructions for ACS880 multidrive cabinets and modules (3AUA0000102324 [English]).

Marine type approvals

You can find the ACS880-307...+A018 +C132 marine type approval certificates on the Internet. Go to www.abb.com/drives/documents. Browse or enter selection criteria in the search field.



ACS880-607...+C132, 1-phase

Contents of this chapter

This chapter contains an overview and the ratings for the ACS880-607...+C132, single phase brake unit.

Product overview

The ACS880-607...+C132 is a marine type-approved cabinet-installed brake unit.

Mechanical installation

Obey the instructions in Mechanical installation instructions for ACS880 multidrive cabinets (3AUA0000101764 [English]) and the hardware manual.

Electrical installation

Obey the instructions in Electrical planning instructions for ACS880 multidrive cabinets and modules (3AUA0000102324 [English]) and the hardware manual.

Technical data

■ Ratings

Brake unit type ACS880-607-...	Module type	P_{brmax} kW	R_{tot} ohm	I_{max} A	I_{rms} A	$P_{cont.}$ kW	Duty cycle (1 min/5 min)		Duty cycle (10 s/60 s)	
							P_{br} kW	I_{rms} A	P_{br} kW	I_{rms} A
$U_N = 400 \text{ V}$ (Range 380 ... 415 V)										
0320-3	NBRA-659	335	1.20	518	142	91	288	445	335	518
0640-3	2×NBRA-659	671	0.60	1036	283	182	576	889	671	1036
0960-3	3×NBRA-659	1005	0.40	1553	425	274	864	1334	1006	1553
1280-3	4×NBRA-659	1340	0.30	2071	566	365	1151	1778	1341	2071
1600-3	5×NBRA-659	1676	0.24	2589	708	456	1439	2223	1677	2589
1920-3	6×NBRA-659	2011	0.20	3107	849	547	1727	2668	2012	3107
$U_N = 400 \text{ V}$ (Range 380 ... 415 V)										
0320-3+D151	NBRA-659	335	1.20	518	80	51	159	422	273	422
0640-3+D151	2×NBRA-659	671	0.60	1036	160	103	316	488	546	844
0960-3+D151	3×NBRA-659	1005	0.40	1553	239	154	475	732	819	1265
1280-3+D151	4×NBRA-659	1340	0.30	2071	319	205	634	977	1093	1687
1600-3+D151	5×NBRA-659	1676	0.24	2589	399	257	791	1221	1365	2109
1920-3+D151	6×NBRA-659	2011	0.20	3107	479	308	950	1465	1638	2531
$U_N = 500 \text{ V}$ (Range 380 ... 500 V)										
0400-5	NBRA-659	383	1.43	542	129	104	301	371	383	473
0800-5	2×NBRA-659	766	0.72	1085	258	207	602	743	766	946
1200-5	3×NBRA-659	1148	0.48	1627	388	311	903	1114	1149	1419
1600-5	4×NBRA-659	1530	0.36	2170	517	414	1205	1486	1531	1892
2000-5	5×NBRA-659	1913	0.29	2712	646	518	1506	1857	1914	2366
2400-5	6×NBRA-659	2296	0.24	3255	775	621	1807	2229	2297	2839
$U_N = 500 \text{ V}$ (Range 380...500 V)										
0400-5+D151	NBRA-659	383	1.35	575	64	51	159	196	273	337
0800-5+D151	2×NBRA-659	766	0.68	1150	127	103	316	391	546	675
1200-5+D151	3×NBRA-659	1148	0.45	1724	191	154	475	587	819	1012
1600-5+D151	4×NBRA-659	1530	0.34	2299	255	205	634	783	1093	1349
2000-5+D151	5×NBRA-659	1913	0.27	2874	318	257	791	979	1365	1686
2400-5+D151	6×NBRA-659	2296	0.23	3449	382	308	950	1174	1638	2024

Brake unit type ACS880-607-...	Module type	P_{brmax} kW	R_{tot} ohm	I_{max} A	I_{rms} A	$P_{cont.}$ kW	Duty cycle (1 min/5 min)		Duty cycle (10 s/60 s)	
							P_{br} kW	I_{rms} A	P_{br} kW	I_{rms} A
$U_N = 690$ V (Range 525...690 V)										
0400-7	NBRA-669	384	2.72	393	102	113	283	254	384	343
0800-7	2×NBRA-669	767	1.36	787	203	226	566	507	768	686
1200-7	3×NBRA-669	1150	0.91	1180	305	339	849	761	1151	1029
1600-7	4×NBRA-669	1534	0.68	1573	407	452	1132	1015	1535	1372
2000-7	5×NBRA-669	1918	0.54	1967	508	565	1416	1268	1919	1715
2400-7	6×NBRA-669	2301	0.45	2360	610	678	1699	1522	2303	2058
0400-7+D151	NBRA-659	384	1.35	793	92	51	159	142	273	244
0800-7+D151	2×NBRA-659	767	0.68	1587	184	103	316	283	546	488
1200-7+D151	3×NBRA-659	1150	0.45	2380	276	154	475	425	819	732
1600-7+D151	4×NBRA-659	1534	0.34	3173	369	205	634	566	1093	977
2000-7+D151	5×NBRA-659	1918	0.27	3966	461	257	791	708	1365	1221
2400-7+D151	6×NBRA-659	2301	0.23	4760	553	308	950	849	1638	1465
3AXD10000501309										

Definitions

Example: ACS880-607-0640-3

Brake unit

P_{brmax}	Maximum braking power per brake unit allowed momentarily
R	Nominal resistance of the brake resistors connected to one brake chopper unit
R_{tot}	Total recommended brake resistor resistance of the listed resistor assembly
I_{max}	Peak brake current (DC) per chopper
$P_{cont.}$	Continuous braking power per brake unit. The braking is considered continuous if the braking time exceeds 10 minutes

Duty cycle (10 s / 60 s)

I_{rms}	Total rms DC current (per chopper) during a period of 1 minute with braking power P_{br}
P_{br}	Short term braking power per brake unit allowed for 10 seconds every 60 seconds

Duty cycle (1 min / 5 min)

I_{rms}	Total rms DC current (per chopper) during a period of 1 minute with braking power P_{br}
P_{br}	Short term braking power per brake unit allowed for one minute every 5 minutes

Brake current wave form

I_{max}	
I_{rms}	
0	

Note: The ratings apply at an ambient temperature of 45 °C (113 °F).

Applicable standards

See Electrical planning instructions for ACS880 multidrive cabinets and modules (3AUA0000102324 [English]).

Marine type approvals

You can find the ACS880-607...+C132 marine type approval certificates on the Internet. Go to www.abb.com/drives/documents. Browse or enter selection criteria in the search field.



ACS880-607...+C132, 3-phase

Contents of this chapter

This chapter contains an overview and the ratings for the ACS880-607...+C132, 3-phase brake unit.

Product overview

The ACS880-607...+C132 is a marine type-approved cabinet-installed brake unit.

Mechanical installation

Obey the instructions in Mechanical installation instructions for ACS880 multidrive cabinets (3AUA0000101764 [English]) and the hardware manual.

Electrical installation

Obey the instructions in Electrical planning instructions for ACS880 multidrive cabinets and modules (3AUA0000102324 [English]) and the hardware manual.

Technical data

■ Ratings

Brake unit type ACS880-607-...	Frame size	Resistor values		Ratings at R_{min}						
				No-overload use			Cyclic load (1 min / 5 min)			
		R_{min}	R_{max}	I_2	I_2	$P_{cont-max}$ (S_N)	I_{max}	I_{dc}	I_{rms}	P_{br}
		Ohm	Ohm	A (DC)	A (DC)	kW (kVA)	A (DC)	A (DC)	A (DC)	kW
U _N = 400 V										
0500-3	1×R8i	1.8	2.2	742	295	480	352	949	333	610
0750-3	1×R8i	1.2	1.4	1113	442	720	527	1424	500	920
1000-3	2×R8i	1.8	2.2	1483	590	950	703	1898	667	1220
1510-3	2×R8i	1.2	1.4	2225	884	1430	1055	2847	1000	1830
2260-3	3×R8i	1.2	1.4	3338	1327	2150	1582	4271	1501	2750
3010-3	4×R8i	1.2	1.4	4450	1769	2860	2109	5694	2001	3660
3770-3	5×R8i	1.2	1.4	5563	2211	3580	2636	7118	2501	4580
U _N = 500 V										
0630-5	1×R8i	2.3	2.7	742	295	600	352	949	333	760
0940-5	1×R8i	1.5	1.8	1113	442	890	527	1424	500	1150
1260-5	2×R8i	2.3	2.7	1483	590	1190	703	1898	667	1530
1880-5	2×R8i	1.5	1.8	2225	884	1790	1055	2847	1000	2290
2830-5	3×R8i	1.5	1.8	3338	1327	2680	1582	4271	1501	3440
3770-5	4×R8i	1.5	1.8	4450	1769	3580	2109	5694	2001	4580
4710-5	5×R8i	1.5	1.8	5563	2211	4470	2636	7118	2501	5730
U _N = 690 V										
0870-7	1×R8i	3.2	3.7	742	295	820	352	949	333	1050
1300-7	1×R8i	2.1	2.5	1113	442	1240	527	1424	500	1580
1730-7	2×R8i	3.2	3.7	1483	590	1650	703	1898	667	2110
2600-7	2×R8i	2.1	2.5	2225	884	2470	1055	2847	1000	3160
3900-7	3×R8i	2.1	2.5	3338	1327	3710	1582	4271	1501	4740
5200-7	4×R8i	2.1	2.5	4450	1769	4940	2109	5694	2001	6320
6500-7	5×R8i	2.1	2.5	5563	2211	6180	2636	7118	2501	7900
3AXD10000501309										

Brake unit type ACS880-607-	Frame size	Resistor values		Ratings at R_{min}						
				No-overload use			Cyclic load (1 min / 5 min)			
		R_{min}	R_{max}	I_2	I_2	$P_{cont-max}$ (S_N)	I_{max}	I_{dc}	I_{rms}	P_{br}
Ohm	Ohm	A (DC)	A (DC)	kW (kVA)	A (DC)	A (DC)	A (DC)	kW		
$U_N = 400\text{ V}$										
0500-3	1×R8i	1.8	2.2	742	269	480	297	790	277	510
0750-3	1×R8i	1.2	1.4	1113	413	720	445	1241	436	800
1000-3	2×R8i	1.8	2.2	1483	538	950	593	1579	555	1020
1510-3	2×R8i	1.2	1.4	2225	826	1430	890	2482	872	1600
2260-3	3×R8i	1.2	1.4	3338	1239	2150	1335	3723	1308	2400
3010-3	4×R8i	1.2	1.4	4450	1651	2860	1780	4964	1744	3190
3770-3	5×R8i	1.2	1.4	5563	2064	3580	2225	6205	2180	3990
$U_N = 500\text{ V}$										
0630-5	1×R8i	2.3	2.7	742	271	600	297	804	283	650
0940-5	1×R8i	1.5	1.8	1113	407	890	445	1207	424	970
1260-5	2×R8i	2.3	2.7	1483	543	1190	593	1609	565	1290
ACS880-607- 1880-5	2×R8i	1.5	1.8	2225	814	1790	890	2413	848	1940
2830-5	3×R8i	1.5	1.8	3338	1221	2680	1335	3620	1272	2910
3770-5	4×R8i	1.5	1.8	4450	1628	3580	1780	4826	1696	3880
4710-5	5×R8i	1.5	1.8	5563	2035	4470	2225	6033	2120	4850
$U_N = 690\text{ V}$										
0870-7	1×R8i	3.2	3.7	742	272	820	297	810	285	900
1300-7	1×R8i	2.1	2.5	1113	406	1240	445	1199	421	1330
1730-7	2×R8i	3.2	3.7	1483	545	1650	593	1620	569	1800
2600-7	2×R8i	2.1	2.5	2225	812	2470	890	2398	842	2660
3900-7	3×R8i	2.1	2.5	3338	1217	3710	1335	3596	1264	3990
5200-7	4×R8i	2.1	2.5	4450	1623	4940	1780	4795	1685	5320
6500-7	5×R8i	2.1	2.5	5563	2029	6180	2225	5994	2106	6650
3AXD10000501309										

Definitions

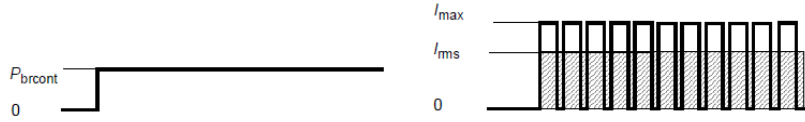
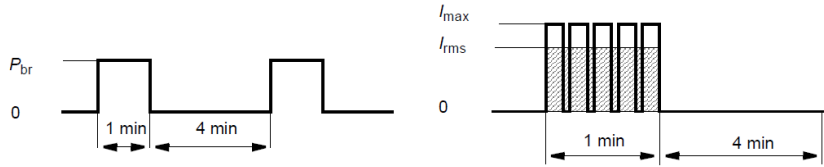
U_N	Nominal voltage
R_{min}	Minimum allowed resistance value of the brake resistor per one phase of the brake module
R_{max}	Maximum resistance value of the brake resistor per one phase of the brake module
Note:	Connect one resistor per brake module phase. For example, a brake unit of frame size 2xR8i includes two brake modules -> 2 x 3 resistors are needed.
No-overload use at R_{max}	
I_1	Input current
I_2	Output current. This is indicated the type designation label as 3x the value given in this table.
$P_{cont.max}$	Maximum continuous braking power per brake unit 
S_N	Apparent power
I_{rms}	Output current
Cyclic load (1 min / 5 min)	
I_{max}	Peak brake current (DC) per chopper module phase
I_{dc}	Input current
I_{rms}	Total rms DC current per brake unit phase during a period of 1 minute with braking power P_{br}
P_{br}	Short term braking power per brake unit allowed for one minute every 5 minutes 
Example: Brake unit with two parallel brake modules	

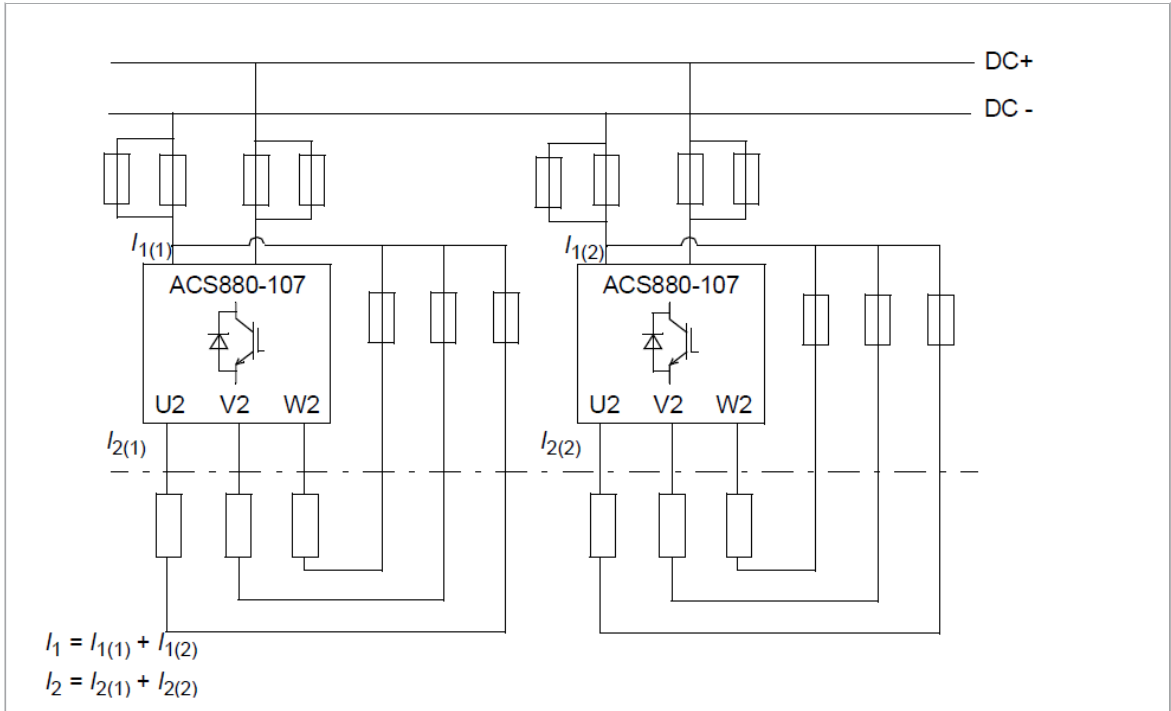

Note: The ratings apply at an ambient temperature of 45 °C (113 °F).

Ambient temperature (surrounding air) derating

In the temperature range +45...50 °C (+113...122 °F), the rated output current is derated by 1% for every added 1 °C (1.8 °F) as follows.

To calculate the output current, multiply the current in the ratings table by the derating factor (k).

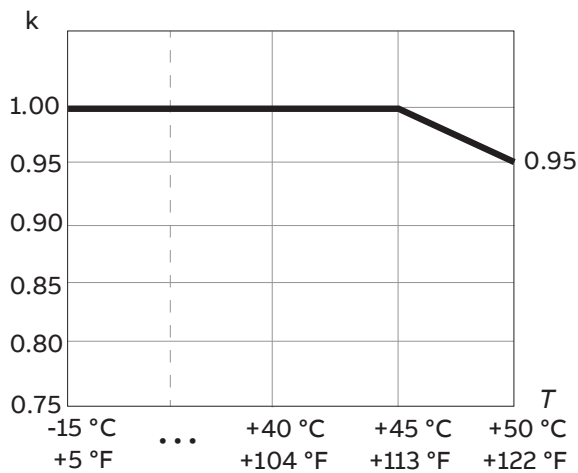

Applicable standards

See Electrical planning instructions for ACS880 multidrive cabinets and modules (3AUA0000102324 [English]).

50 ACS880-607...+C132, 3-phase

Marine type approvals

You can find the ACS880-607...+C132 marine type approval certificates on the Internet. Go to www.abb.com/drives/documents. Browse or enter selection criteria in the search field.



ACS880-1607...+C132

Contents of this chapter

This chapter contains an overview and the ratings for the ACS880-1607...+C132.

Product overview

The ACS880-1607...+C132 is a marine type-approved DC/DC converter unit.

Mechanical installation

Obey the instructions in Mechanical installation instructions for ACS880 multidrive cabinets (3AUA0000101764 [English]) and the hardware manual.

Electrical installation

Obey the instructions in Electrical planning instructions for ACS880 multidrive cabinets and modules (3AUA0000102324 [English]) and the hardware manual.

Technical data

■ Ratings

Unit type ACS880- 1607-...	Consists of module type ACS880- 104-...	Frame	No-overload use							
			I_2	I_2	$P_{\text{cont-max}}$	$I_{\text{cont-max}}$	$I_{\text{max out-put}}$	S_N	I_{p2p}	$f_{\text{sw out}}$
			A (DC)	A (DC)	kW	hp	A (DC)	kVA	A (DC)	Hz
U _N = 400 V										
0600A-3	0640A-3	1×R8i	570	570	290	389	855	290	26	12000
0900A-3	0900A-3	1×R8i	855	855	435	584	1283	435	39	12000
1200A-3	0640A-3	2×R8i	1140	1140	580	778	1710	580	52	12000
1800A-3	0900A-3	2×R8i	1710	1710	871	1167	2565	871	79	12000
2700A-3	0900A-3	3×R8i	2565	2565	1306	1751	3848	1306	118	12000
3600A-3	0900A-3	4×R8i	3420	3420	1741	2335	5130	1741	157	12000
4500A-3	0900A-3	5×R8i	4275	4275	2176	2919	6413	2176	196	12000
U _N = 500 V										
0600A-5	0590A-5	1×R8i	570	570	363	486	855	363	33	12000
0900A-5	0810A-5	1×R8i	855	855	544	730	1283	544	49	12000
1200A-5	0590A-5	2×R8i	1140	1140	725	973	1710	725	65	12000
1800A-5	0810A-5	2×R8i	1710	1710	1088	1459	2565	1088	98	12000
2700A-5	0810A-5	3×R8i	2565	2565	1632	2189	3848	1632	147	12000
3600A-5	0810A-5	4×R8i	3420	3420	2176	2919	5130	2176	196	12000
4500A-5	0810A-5	5×R8i	4275	4275	2721	3648	6413	2721	246	12000
UN = 690 V										
0400A-7	0410A-7	1×R8i	380	380	334	448	570	334	45	12000
0600A-7	0600A-7	1×R8i	570	570	501	671	855	501	68	12000
0800A-7	0410A-7	2×R8i	760	760	667	895	1140	667	90	12000
1200A-7	0600A-7	2×R8i	1140	1140	1001	1343	1710	1001	136	12000
1800A-7	0600A-7	3×R8i	1710	1710	1502	2014	2565	1502	203	12000
2400A-7	0600A-7	4×R8i	2280	2280	2002	2685	3420	2002	271	12000
3000A-7	0600A-7	5×R8i	2850	2850	2503	3356	4275	2503	339	12000
3AXD10000501309										

Unit type ACS880- 1607-...	Consists of module type ACS880- 104-...	Frame	High-overload use		Heavy-duty use	
			I_{fast}	P_{fast}	I_{hd}	P_{hd}
			A	kW	A	kW
$U_N = 400\text{ V}$						
0600A-3	0640A-3	1xR8i	427	218	484	247
0900A-3	0900A-3	1xR8i	641	326	726	370
1200A-3	0640A-3	2xR8i	854	435	969	493
1800A-3	0900A-3	2xR8i	1282	653	1453	740
2700A-3	0900A-3	3xR8i	1923	979	2179	1110
3600A-3	0900A-3	4xR8i	2563	1305	2906	1479
4500A-3	0900A-3	5xR8i	3204	1631	3632	1849
$U_N = 500\text{ V}$						
0600A-5	0590A-5	1xR8i	427	272	484	308
0900A-5	0810A-5	1xR8i	641	408	726	462
1200A-5	0590A-5	2xR8i	854	544	969	616
1800A-5	0810A-5	2xR8i	1282	816	1453	925
2700A-5	0810A-5	3xR8i	1923	1224	2179	1387
3600A-5	0810A-5	4xR8i	2563	1631	2906	1849
4500A-5	0810A-5	5xR8i	3204	2039	3632	2312
$U_N = 690\text{ V}$						
0400A-7	0410A-7	1xR8i	285	250	323	284
0600A-7	0600A-7	1xR8i	427	375	484	425
0800A-7	0410A-7	2xR8i	570	500	646	567
1200A-7	0600A-7	2xR8i	854	750	969	851
1800A-7	0600A-7	3xR8i	1282	1126	1453	1276
2400A-7	0600A-7	4xR8i	1709	1501	1937	1701
3000A-7	0600A-7	5xR8i	2136	1876	2422	2127
3AXD10000501309						

Definitions

U_N	Nominal voltage
Nominal ratings	
I_1	DC input current

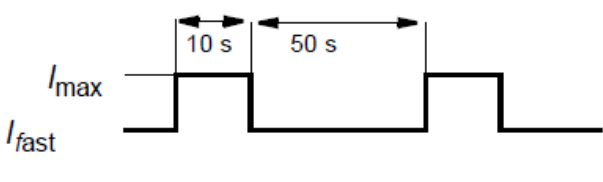
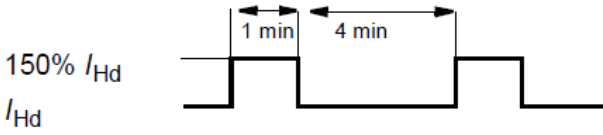
I_2	Continuous output current (RMS)
$P_{\text{cont.max}}$	Maximum continuous active power
S_N	Nominal apparent power
$I_{\text{max output}}$	Maximum output current
I_{p2p}	Peak-to-peak value of output current ripple measured after the filter
$f_{\text{sw out}}$	Switching frequency at output terminals (energy storage connection) measured after the filter
High-overload use	
I_{fast}	Continuous current allowing I_{max} for 10 s / 60 s at 45 °C (113 °F) 
P_{fast}	Continuous power allowing I_{max} for 10 s / 60 s at 45 °C (113 °F)
Heavy-duty use	
I_{hd}	Continuous current allowing 150% I_{Hd} for 1 min / 5 min at 45 °C (113 °F) 
P_{hd}	Continuous power allowing 150% I_{Hd} for 1 min / 5 min at 45 °C (113 °F)

Note: The ratings apply at an ambient temperature of 45 °C (113 °F).

Ambient temperature (surrounding air) derating

In the temperature range +45...50 °C (+113...122 °F), the rated output current is derated by 1% for every added 1 °C (1.8 °F) as follows.

To calculate the output current, multiply the current in the ratings table by the derating factor (k).

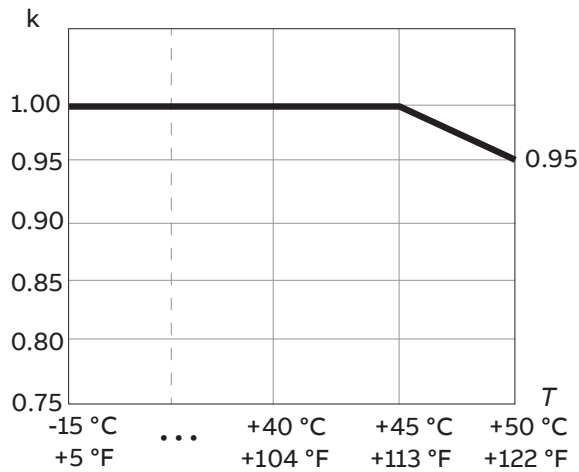

Applicable standards

See Electrical planning instructions for ACS880 multidrive cabinets and modules (3AUA0000102324 [English]).

Marine type approvals

You can find the ACS880-1607...+C132 marine type approval certificates on the Internet. Go to www.abb.com/drives/documents. Browse or enter selection criteria in the search field.

Further information

Product and service inquiries

Address any inquiries about the product to your local ABB representative, quoting the type designation and serial number of the unit in question. A listing of ABB sales, support and service contacts can be found by navigating to www.abb.com/contact-centers.

Product training

For information on ABB product training, navigate to new.abb.com/service/training.

Providing feedback on ABB manuals

Your comments on our manuals are welcome. Navigate to forms.abb.com/form-26567.

Document library on the Internet

You can find manuals and other product documents in PDF format on the Internet at www.abb.com/drives/documents.



www.abb.com/drives



3AXD50000039629C