

DATASHEET

ABB wall-mounted TPHE 150 kA series

Surge protective devices



Product features

- UL Listed 1449 5th Edition, Type 1, Type 2
- cUL Listed, CSA C22.2
- UL 96A, for use in lightning protection systems
- Thermally protected MOV design eliminates the need for additional upstream over-current protection
- Standard features include a surge counter, audible alarm, indicating lights and dry contacts
- 10-year limited warranty

Available configurations

Model number	Voltage	Configuration
TPHE120S15WMN	240/120	1-phase, 3-wire + ground
TPHE120Y15WMN	208Y/120	3-phase, 4-wire + ground
TPHE220Y15WMN	380Y/220	3-phase, 4-wire + ground
TPHE240D15WMN	240 Delta	3-phase, 3-wire + ground
TPHE240H15WMN	240/120 High-Leg Delta	3-phase, 4-wire + ground
TPHE240Y15WMN	415Y/240	3-phase, 4-wire + ground
TPHE277Y15WMN	480Y/277	3-phase, 4-wire + ground
TPHE347Y15WMN	600Y/347	3-phase, 4-wire + ground
TPHE480D15WMN	480 Delta	3-phase, 3-wire + ground

Product specifications and performance data

Product specifications

Electrical	
Maximum surge current rating	300 kA per phase, 150 kA per mode
Nominal discharge current rating	20 kA
Operating frequency	50–60 Hz
Surge life (IEEE C62.41–C3 10 kA)	>20,000 impulses
Connection method	#6 to 2/0 AWG conductors, parallel connected
Modes of protection	All modes (L-N, L-G, N-G, L-L)
Fault rating (SCCR)	200 kA
Standard monitoring	Status indicator lights (one per phase) and red service light Audible alarm with silencer and test switch Contacts for remote monitoring (2 amp, 125 V AC)–(1 amp, 30 V DC) 6-digit LCD re-settable surge event counter

Mechanical

Weight	Varies and depends on enclosure type; please see available options below
Installation location	Service entrance equipment, primary distribution equipment
Mounting method	Surface mount, 4-point mounting brackets
Operating environment	-40 °F to 149 °F (-40 °C to 65 °C)
Altitude	0–12,000 ft. (3.66 km)
Product design	Individually fused thermally protected MOV technology

Regulatory

UL 1449 5th Edition	VZCA: E320456 Type 1 / Type 2
cUL, CSA C22.2	VZCA7: E320456 Type 2 / Type 2
UL 1283	FOKY: E320456 Type 2
UL 96A	Yes
IEEE C62.62, C62.72, C62.41	Yes
Listed by	UL

EMI/RFI filter attenuation

Max. attenuation frequency	-50 dB minimum at 100 kHz
----------------------------	---------------------------

Warranty

10-year limited warranty

Options	Suffix	UL type	Weight
Painted steel, NEMA 4 surface mount	4S	Type 2	44 lbs. (20.0 kg)
Stainless steel, NEMA 4X surface mount	4X	Type 2	50 lbs. (22.7 kg)
Painted steel, NEMA 1 surface mount, integral disconnect	1	Type 2	63 lbs. (28.5 kg)
Fiberglass, NEMA 4X surface mount, integral disconnect	4	Type 2	56 lbs. (25.4 kg)
Painted steel, NEMA 4 surface mount	4ST1	Type 1	44 lbs. (20.0 kg)
Stainless steel, NEMA 4X surface mount	4XT1	Type 1	50 lbs. (22.7 kg)
Painted steel, NEMA 1 surface mount, integral disconnect	1T1	Type 1	63 lbs. (28.5 kg)
Fiberglass, NEMA 4X surface mount, integral disconnect	4T1	Type 1	56 lbs. (25.4 kg)

Performance data

Model number	Protection mode	MCOV	VPR	IEEE Cat. B3	IEEE Cat. B3/	IEEE Cat. C3
				100 kHz/500 A	C1 6 kV/3 kA	20 kV/10 kA
TPHE120S	L-L	300	1200	752	844	1007
	L-N	150	900	470	600	793
	L-G	150	800	463	485	670
TPHE120Y	N-G	150	700	452	476	680
	L-L	300	1200	752	844	1007
	L-N	150	900	470	600	793
TPHE220Y	L-G	150	800	463	485	670
	N-G	150	700	452	476	680
	L-L	640	2000	1393	1597	1827
TPHE220Y	L-N	320	1500	763	1053	1170
	L-G	320	1200	836	893	1073
	N-G	320	1200	828	880	1180
TPHE240D	L-L	540	1800	1240	1453	1640
	L-N	–	–	–	–	–
	L-G	270	1200	750	763	890
TPHE240H	N-G	–	–	–	–	–
	L-L	300	2000	752	844	1007
	L-N	150	1000	470	600	793
TPHE240Y	L-G	150	800	463	485	670
	N-G	150	700	452	476	680
	H-L	420	2500	1393	1597	1827
TPHE240Y	H-N	270	1200	763	1053	1170
	H-G	270	1200	836	893	1073
	L-L	640	2000	1393	1597	1827
TPHE240Y	L-N	320	1500	763	1053	1170
	L-G	320	1200	836	893	1073
	N-G	320	1200	828	880	1180
TPHE277Y	L-L	640	2000	1340	1597	1827
	L-N	320	1500	727	1053	1170
	L-G	320	1200	800	893	1073
TPHE347Y	N-G	320	1200	792	880	1180
	L-L	840	2500	1723	2020	2220
	L-N	420	1500	883	1187	1467
TPHE347Y	L-G	420	1500	1000	1113	1240
	N-G	420	1500	1000	1120	1240
	L-L	1110	3000	1800	2647	2933
TPHE480D	L-N	–	–	–	–	–
	L-G	550	1800	1223	1407	1607
	N-G	–	–	–	–	–

Dimensional specifications

—
WMN1/WMN1T1
suffix

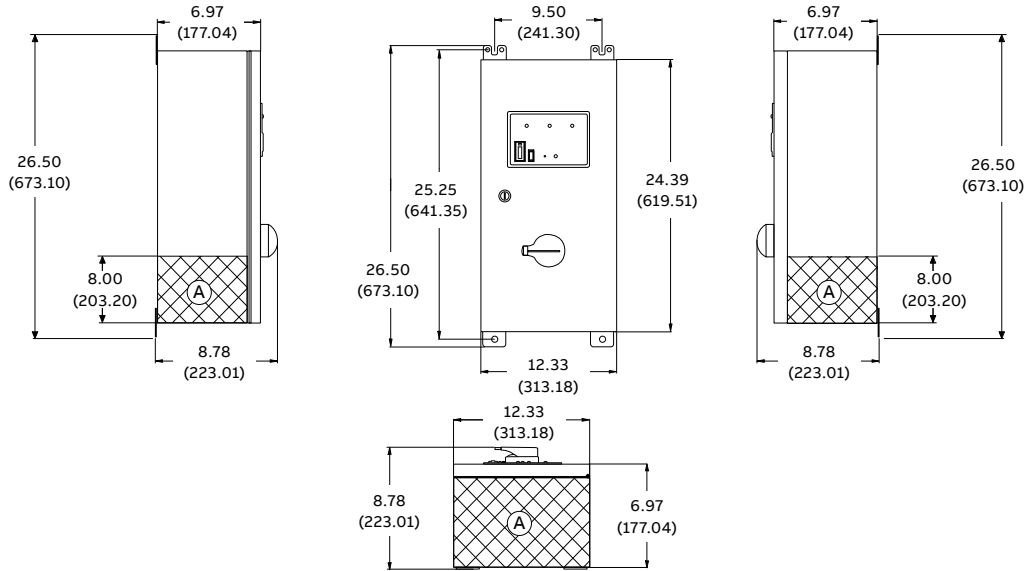

—
WMN4/WMN4T1
suffix

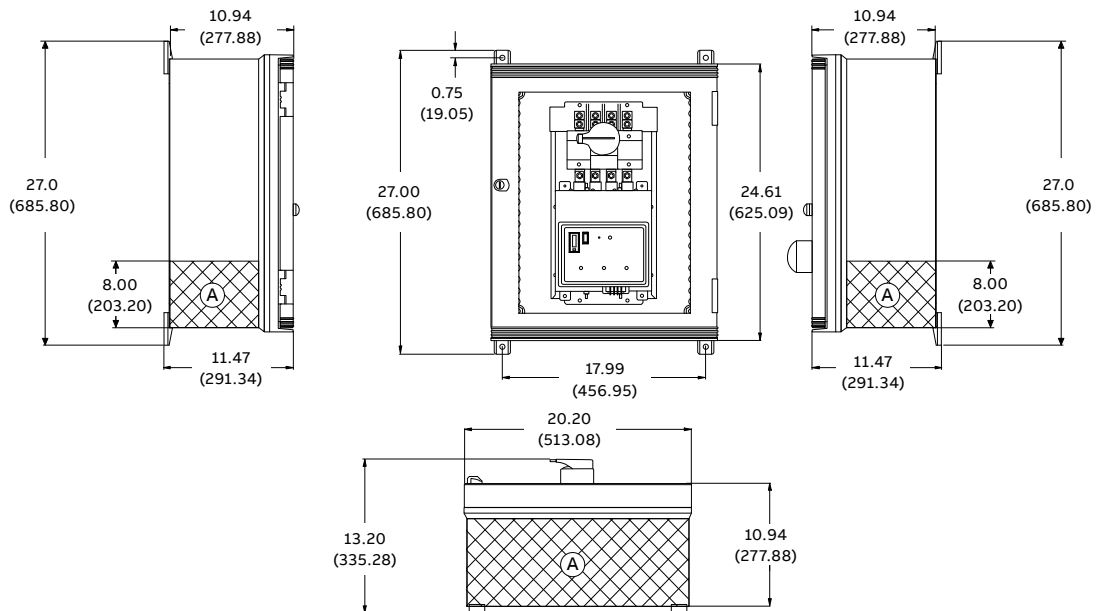

Note:
All dimensions are for reference only
and are shown in inches (millimeters).
"A" = Recommended conduit entry areas.

Dimensional specifications

WMN4S/WMN4ST1,
WMN4X/WMN4XT1

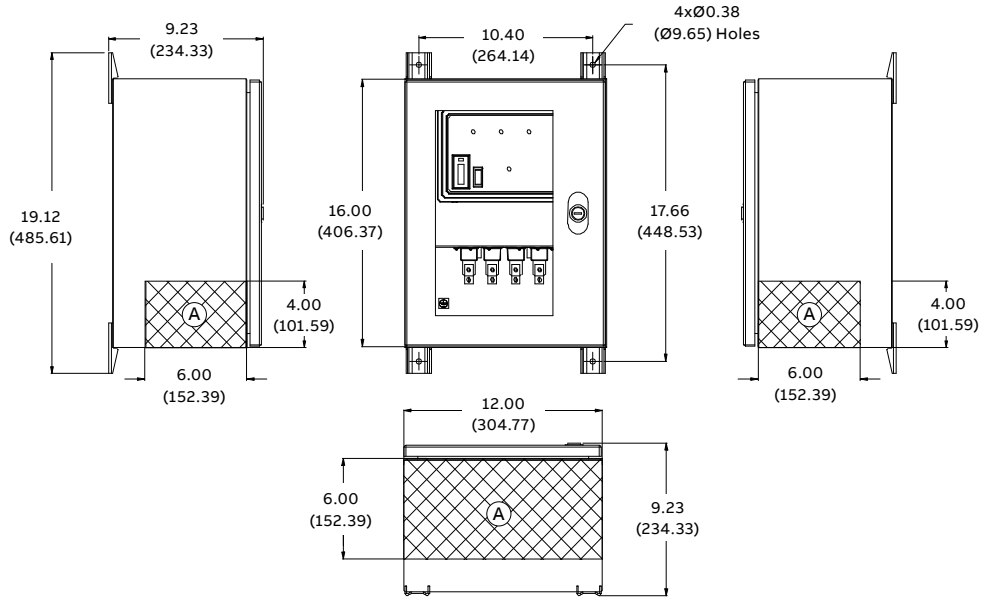

Note:
All dimensions are for reference only
and are shown in inches (millimeters).
"A" = Recommended conduit entry areas.

ABB Inc.
305 Gregson Drive
Cary, NC 27511
United States

We reserve the right to make technical changes or modify the contents of this document without prior notice. With regard to purchase orders, the agreed particulars shall prevail. ABB does not accept any responsibility whatsoever for potential errors or possible lack of information in this document

We reserve all rights in this document and in the subject matter and illustrations contained therein. Any reproduction, disclosure to third parties or utilization of its contents – in whole or in parts – is forbidden without prior written consent of ABB. Copyright © 2023 ABB