

Instrument Transformers

Technical Information and Application Guide



Table of Contents

Technology Review

An introduction to instrument transformer fundamentals, a discussion on power quality, and a detailed explanation of design considerations to assist in selecting an instrument transformer.

3

Product Description

A general overview of ABB's current and voltage transformers. This section is complemented with photographs and describes the specific classes and uses for instrument transformers.

37

Technology Review

Introduction	4
Types of Construction	6
Performance Characteristics	8
Accuracy Classifications for Metering	12
Burdens	13
Current Transformers: Accuracy Classes for Relaying	15
Insulation Systems	16
Voltage Ratings	18
Power Quality	22
Service Conditions	24
Auxiliary Current Transformers	31
Fusing Voltage Transformers	32
New Design Technologies	33

Introduction

Instrument transformers (ITs) are designed to transform voltage or current from the high values in the transmission and distribution systems to the low values that can be utilized by low voltage metering devices. There are three primary applications for which ITs are used: metering (for energy billing and transaction purposes); protection control (for system protection and protective relaying purposes); and load survey (for economic management of industrial loads).

Depending on the requirements for those applications, the IT design and construction can be quite different. Generally, the metering ITs require high accuracy in the range of normal operating voltage and current. Protection ITs require linearity in a wide range of voltages and currents. During a disturbance, such as system fault or overvoltage transients, the output of the IT is used by a protective relay to initiate an appropriate action (open or close a breaker, reconfigure the system, etc.) to mitigate the disturbance and protect the rest of the power system. Instrument transformers are the most common and economic way to detect a disturbance. Typical output levels of instrument transformers are 1-5 amperes and 115-120 volts for CTs and VTs, respectively. There are several classes of accuracy for instrument transformers defined by the IEEE, CSA, IEC, and ANSI standards. Figure 1 presents a conceptual design of CTs and VTs.

Figure 2 shows how the polarity markers are used to keep the direction of current flow in the meters exactly the same, as if the primary circuit was carried through the meters. Grounding of the secondary circuit is most important, but in complicated three-phase connections, the best point to ground is not always easily determined.

Figure 1: Current and Voltage Transformer Symbols and Simplified Concepts

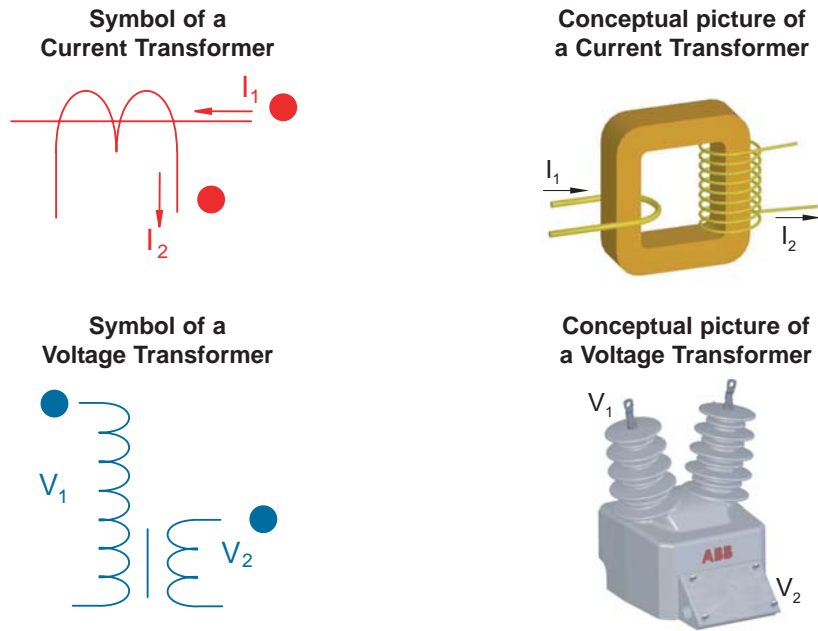
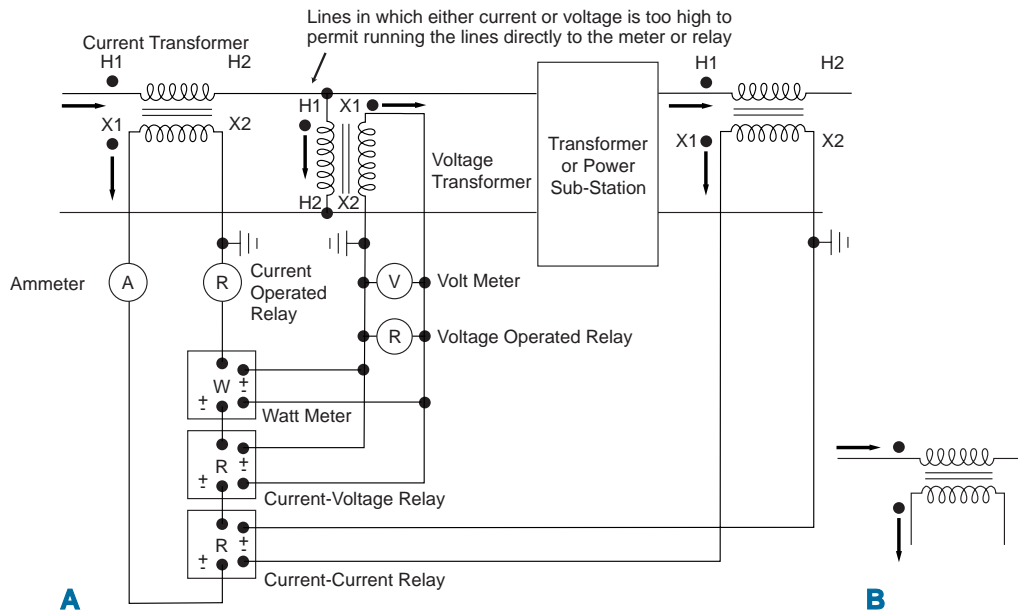

Figure 2: Instrument Transformer Connections



- A.** The current transformer is designed to connect in series with the line to transform the line current to the standard 5 amperes suitable for the meter or relay. The voltage transformer is designed to connect in parallel with the line to transform the line voltage to 115 or 120 volts suitable for the meter or relay. To keep the voltage at the meters and relays at a safe value, the secondary circuit must be grounded.
- B.** The polarity markers indicate the relative instantaneous directions of current in the windings. The polarity, or instantaneous direction of current, is of no significant difference for current-operated or voltage-operated devices. Correct operation of current-current, voltage-voltage, or current-voltage devices usually depends on the relative instantaneous directions.

Types of Construction

The principal forms of construction used for instrument transformers, together with standard symbols according to IEEE Standard C57.13, are shown in Figure 3.

Figure 3: Types of Instrument Transformer Construction

Simple Basic Forms

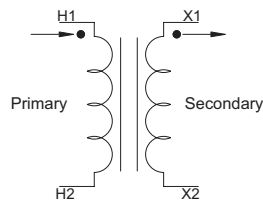

Current Example
5.5 Amperes
Ratio 1:1

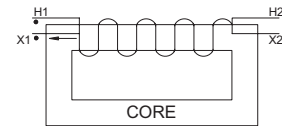

Voltage Example
Primary 7200 Volts
Ratio 60:1 or 7200:120 Volts

Construction Types

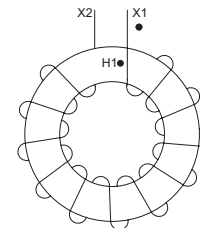
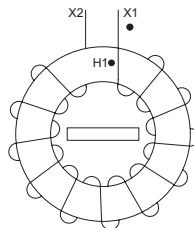
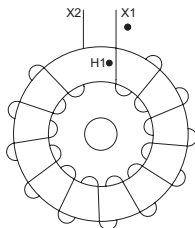

Secondary Types



Dual Ratio Example

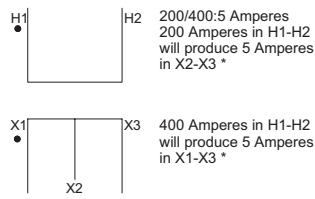

* See nameplate for actual connections

Multi-Ratio Example

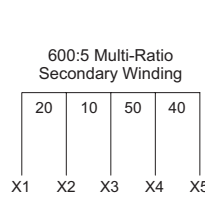

Primary Amperes	Secondary terminals to get 5 Amps
50	X2-X3
100	X1-X2
150	X1-X3
200	X4-X5
250	X3-X4
300	X2-X4
400	X1-X4
450	X3-X5
500	X2-X5
600	X1-X5

Materials Used in Construction

Butyl Rubbers

In the 1970's, the insulating medium for the higher voltage (5-34.5 kV) units was butyl rubber. The material itself is excellent, but the pressures and temperatures necessary to use it as a dielectric were not conducive to the exacting clearances and geometries inside a voltage or current transformer. Without excess bracing, the core/coil assemblies would shift during molding and fail BIL testing. With enough bracing, the material flow inside the unit was restricted, increasing the possibility of voids. For these reasons, another dielectric insulating material was sought. Butyl rubber is still used by some manufacturers.

Cycloaliphatic Epoxies

Cycloaliphatic epoxy (CEP) was first introduced in outdoor insulators in the late 1970's due to its very good resistance to humidity, ultraviolet (UV) radiation, outdoor pollutants, and chemicals. Its outstanding mechanical strength and dielectric properties were also highly desirable.

Aromatic Polyurethanes

Aromatic polyurethane (PUR) elastomers are another cost-effective insulation for medium voltage electrical equipment. There are approximately fourteen general types of PUR that are successfully commercialized for a wide variety of applications, including instrument transformers. Thirteen of these types are called conventional rubber. That means they are mixed, milled, and molded by techniques which have been in use by the rubber industry since the 1920's.

Polyurethane rubber raw materials are liquid, which permits them to be pumped, metered, mixed, and dispensed by machines under very precise control of temperature and ingredient proportions. The liquid mixture enters the mold at vacuum pressure and is cured at slightly elevated temperatures. This unique characteristic allows molding of large parts which are completely uniform throughout. When compared to high pressure-molded butyl rubber and vacuum cast epoxies, PUR in general has the most forgiving process.

The fully cured PUR elastomers possess a desirable balance of ease of manufacturing (via vacuum casting), mechanical toughness (it is, after all, a rubber) and very good electrical properties.

Hydrophobic Cycloaliphatic Epoxy

In the early 2000's, a global epoxy resin supplier introduced a hydrophobic version of CEP called Hydrophobic Cycloaliphatic Epoxy (HCEP) to the market. HCEP is formulated to sustain surface hydrophobicity better than its CEP counterpart upon prolonged exposure to aggressive outdoor environments without sacrificing other desirable chemical and mechanical properties.

A hydrophobic insulation surface is desirable for outdoor applications because it prevents water from developing completely wetted, resistive conductive surfaces. Leakage currents are therefore reduced, which helps to reduce the flashover risk. The result is enhanced reliability. Furthermore, less discharge activity means less attack and therefore less surface erosion, which extends the transformer's life.

Performance Characteristics

Equivalent Circuits

The specific performance characteristics of instrument transformers are easily determined from the equivalent circuit. Figure 4 works well for most instrument transformers. For current transformers, the value of the reactance X is determined in a special way so that it represents the leakage flux. The flux flows in the part of the core represented by the left-hand exciting branch of the equivalent circuit shown in Figure 4.

An additional winding (or windings) placed over the outer leg(s) of the core and connected back in parallel with the secondary winding, as shown in Figure 4, can keep the leakage flux out of the core. The leakage reactance is then effectively connected ahead of both exciting branches as shown in Figure 4. This difference is important for current transformers because leakage flux in the core affects current ratio. It also improves the performance of current transformers and subjects their performance to simple calculation.

Voltage transformers are designed so the through impedance (R_s , R , X_p , and X) is as low as possible, while current transformers are designed so the excitation impedance (Z_o and Z_i) is as high as possible. Neither transformer is very good at performing the function of the other.

Figure 4: Equivalent Circuits

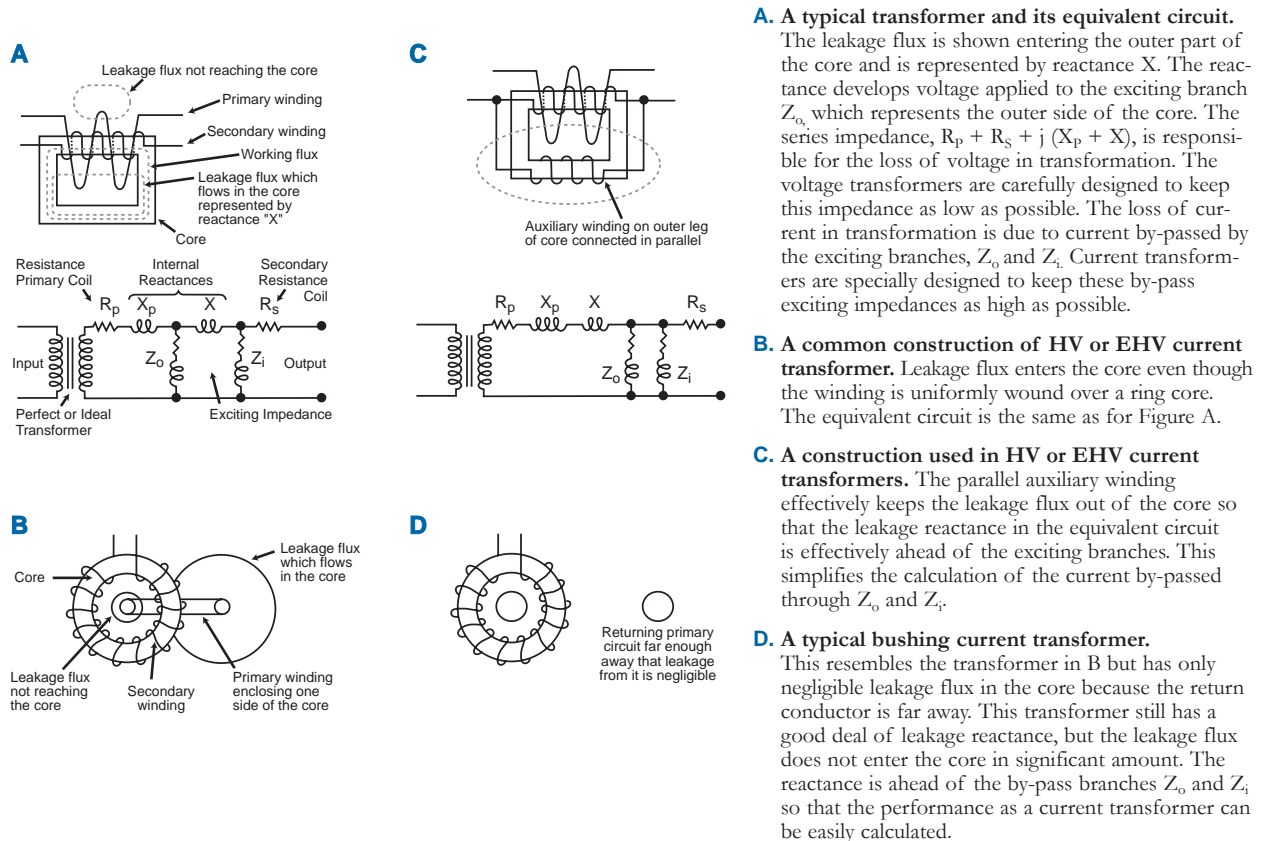

The value of through impedance is constant, but the value of excitation impedance is variable. The exciting impedances representing the exciting currents for the two parts of the core depend on the voltage applied to them, the current flowing in them, or flux density in the core. The easiest way to understand Z_o and Z_i , which are of primary importance in current transformers, is to draw “saturation” curves showing how the current flowing into the exciting branch varies with the voltage applied, as shown in Figure 5. The curve is usually plotted for the combination of Z_o and Z_i in parallel.

Voltage transformers are designed such that the operating point on the saturation curve, as shown in Figure 5, is typically at a relatively high voltage. This is subject to the limitation that this point must not be so high that the exciting current itself is excessive. Voltage transformers are designed to work without excessive exciting current up to 110% of rated voltage. The IEEE standard for performance requires good performance also at 90% voltage. Figure 5 shows that the exciting current will not reach a higher per unit value, with consequent increase of voltage loss from exciting current, at voltages over the range of 5% to 110%.

Figure 5: Typical Transformer Saturation Curve

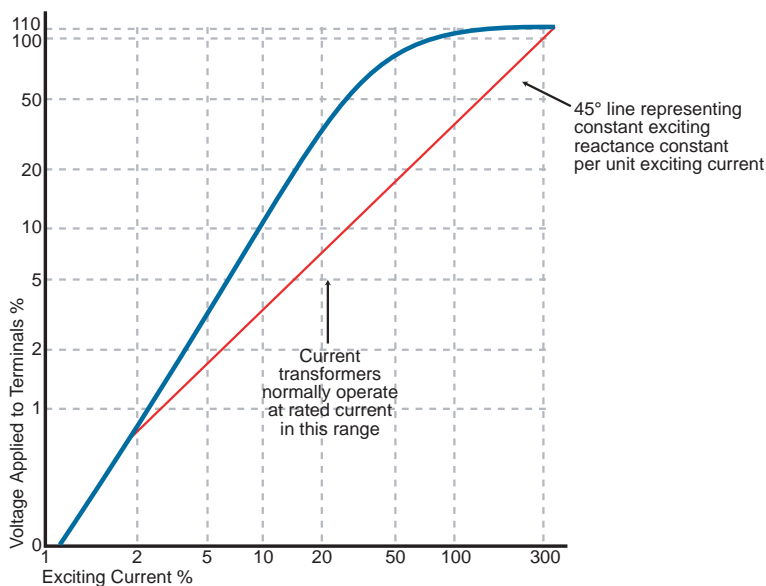

Voltage transformers are designed such that the operating point on the saturation curve is typically at a relatively high voltage.

The voltage must not be so high that the exciting current itself becomes too high. This would cause a voltage drop in the primary impedance that would bring about an excessive error in ratio of phase angle. IEEE C57.13 requires performance standards to be met at 110% of rated voltage. The curve shows the per unit exciting current, below which the error due to voltage drop caused by the exciting current itself will equal that at 110% rated voltage. Performance at voltages down to 5% is not significantly different at the same burden connected to the transformer secondary. The error limits required by C57.13 apply not only at a given burden but at zero burden.

The current transformer, on the other hand, is designed to operate at the low range of the curve (see region marked on the curve) so that the exciting current by-pass will be as low as feasible. The curve shows that as the voltage is reduced, the exciting current is not reduced in proportion. This means, in a current transformer, that as the primary and secondary current decrease, the by-pass current which causes the error actually increases in percentage. The errors in current transformation typically increase at the lower currents.

Ratio Error and Phase Angle

Ideal transformers induce the same voltage per turn in the secondary winding as that applied to the primary voltage transformers. They also produce the same ampere-turns in the secondary as circulated in the primary current transformers, to deliver any desired ratio of primary to secondary voltage or current. In the actual transformer shown in Figure 4, the secondary current output is deficient by the amount of current bypassed by the exciting branches, Z_o and Z_i , and the secondary output voltage is deficient by the voltage drop in the transformer through impedance.

The transformer nameplates show a “marked ratio,” usually an even number, such as 20 to 1. The actual ratio of primary to secondary quantity may be slightly higher or lower than the marked value by an amount¹ called ratio error, which is defined in IEEE C57.13 as ratio correction factor (RCF). For instance, if the actual ratio is 20.2 to 1, then the RCF is 1.01 and the ratio error is 1%. The secondary output may be slightly out of phase with the primary input. This error is called phase angle (usually measured in minutes) and is designated as positive if the secondary output leads the primary input.

1. The ratio of turns is usually adjusted to “compensate” for the losses in the transformer. Because of this “compensation”, the actual secondary output can be higher than would be expected from the marked ratio.

The Effect of Ratio Error and Phase Angle on Wattmeter Readings

If the ratio correction factor exceeds 1.0, the meters will read low and the readings should be multiplied by the correction factor. The effect of phase angle, however, is not as obvious. The transformer correction factor (TCF) determines reasonable limits for RCF and phase angle. This depends on both RCF and phase angle and may be used to correct the reading of a wattmeter. TCF is based on the fact that if the power factor of a metered power load is 60% lagging (represents the usual minimum power factor of actual power loads being metered by watt hour meters), 2.6 minutes of phase angle in the current (or voltage) transformer output will cause 0.1% error in the wattmeter reading.

Voltage Transformers

The RCF and phase angle must be determined at the specific burden involved. However, as with an actual measurement, these values apply to the secondary voltage at the transformer terminals. If the leads from the transformer to the burden are very long, they may have sufficient impedance to introduce additional voltage drop and error. The voltage drop in the leads can be calculated from the current drawn from the transformer and the impedance of the leads. If it is of appreciable magnitude in percent of secondary voltage, the addition to ratio and phase angle error may be calculated according to the vector diagram in Figure 6 and the formulas:

Percent Ratio will be increased by:

$$\frac{I_S (R_L \cos \theta + X_L \sin \theta)}{E_S} \times 100$$

Add this amount to the percent ratio of the transformer to get the actual percent ratio of primary to burden voltage.

The Phase Angle will be increased by:

$$\frac{I_S (R_L \sin \theta - X_L \cos \theta)}{E_S} \times 3438 \text{ Minutes}$$

Add this amount to the phase angle of the transformer (algebraically) to get the actual phase difference between primary and burden voltages.

Figure 6: Effect of Leads in Voltage Transformers

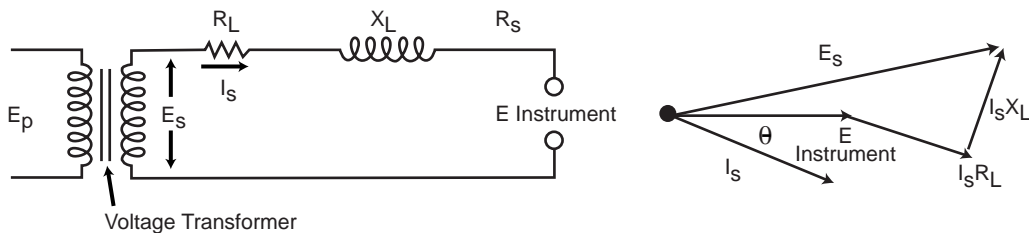

R_L and X_L represent the resistance and reactance in the leads. Method for calculating impedance drops in the leads and resulting ratio and phase angle errors.

Current Transformers

The ratio correction factor and phase angle must be determined at the specific burden and current involved. Current transformer characteristics at special burdens can only be determined by an actual measurement. The test burden must duplicate the actual burden, including the secondary leads. The secondary terminal voltage and power factor must be identical to that of the installation. In addition, these measurements need to be made and applied at the actual service currents.

Accuracy Classifications for Metering

Figures 7 and 8 provide an explanation of accuracy classes for current and voltage transformers. These figures show the Accuracy Classes as adopted by IEEE, as well as the special limitations which apply to current and voltage transformers. IEEE C57.13 has recognized 0.3% as a reasonable error limit and has designated this as “Accuracy Class 0.3.”

Figure 7: The Basic 0.3 Class Parallelogram for Current Transformers

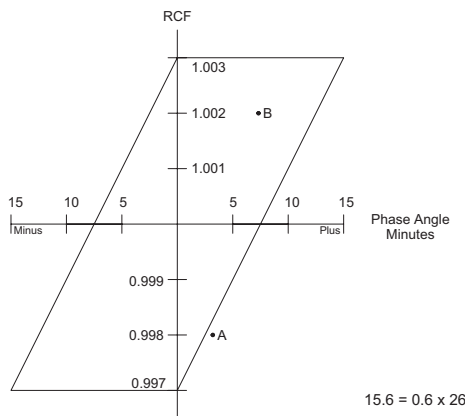

The Figure 7 parallelogram outlines the area in which the measurements of RCF and Phase Angle at 100% current must plot to designate the transformer accuracy as 0.3 Class with TCF within the limits of 0.997 and 1.003. For example, if the RCF at a given burden at 100% current is 0.998 (99.8% Ratio) and the Phase Angle is 3.5 minutes, point A is seen to fall outside the parallelogram.

Another example: RCF = 1.002, Phase Angle 5 minutes, representing greater absolute error, point “B” is now inside the parallelogram and meets the required limits for 0.3 Accuracy Class. In the second case, TCF is less than 1.003 because the effect of phase angle on the wattmeter compensates for the error in ratio.

IEEE C57.13 recognizes that current transformers naturally have greater errors at lower currents, and that error at low current does not usually represent significant error in total registration of kilowatt hours. This permits twice the error at 10% that is permitted at 100% current. The error at the maximum current permitted by the Thermal Rating Factor of the transformer (a multiplier of 1.5 or 4.0 applied to many transformers) is limited to the same value at 100% current.

Other Accuracy Classes: In addition to the 0.3 Class, C57.13 recognizes the 0.6 and 1.2 Classes in which the permissible errors are twice as great (0.6%) and twice again (1.2%) as compared to the 0.3 Class. Any one of these classes may be selected for specification by the user depending on whether 0.3%, 0.6%, or 1.2% seems reasonable for a given application.

Figure 8: The Basic 0.3 Class Parallelogram for Voltage Transformers

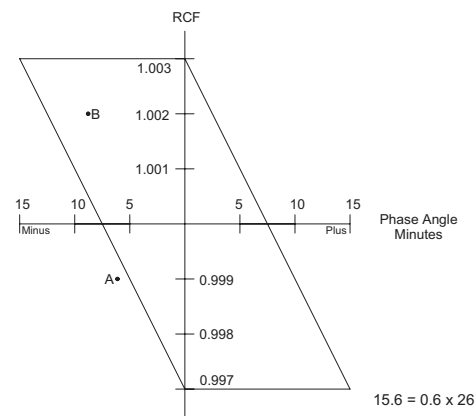

The Figure 8 parallelogram outlines an area in which the measurements of RCF and Phase Angle at 100% (also at 110%) voltage must plot to designate the transformer accuracy as 0.3 Class with TCF within the limits of 0.997 and 1.003. For example, if the measured RCF at a given burden is 0.999 and the phase angle is -8 minutes, point A is seen to fall outside the parallelogram.

Another example: RCF = 1.002, Phase angle is -10 minutes, both representing greater absolute errors, but the point “B” is now inside the parallelogram and meets the required limits for the 0.3 Class. In the second case, the TCF is less than 1.003 because the effect of phase angle on the wattmeter compensates for the phase angle.

The reason for the reversed appearance of Figure 8 compared to Figure 7 is that phase angle in the current transformer brings the secondary current more nearly in phase with the load voltage, increasing the wattmeter reading. In the voltage transformer, the effect is just the opposite.

C57.13 requires that the limits also be met at 90% voltage; in reality, the performance at voltages down to 5% are not significantly different at the same burden connected to the transformer secondary. The error limits required by C57.13 apply not only at a given burden, but also at zero burden.

Other Accuracy Classes: In addition to the 0.3 Class, C57.13 recognizes the 0.6 and 1.2 Classes in which the permissible errors are twice as great (0.6%) and twice again (1.2%) as compared to the 0.3 Class. Any one of these classes may be selected for specification by the user depending on whether 0.3%, 0.6%, or 1.2% seems reasonable for a given application.

Burdens

The errors in ratio and phase angle depend on the impedance connected to the secondary of the transformer. This impedance is commonly referred to as “burden”. The calculations required for determining the performance of a transformer when different burdens are applied are beyond the scope of this discussion. Therefore, the standard burdens as outlined in IEEE C57.13 are used to represent typical service conditions. Each transformer is rated according to its performance at these standard burdens.

Standard Burdens for Current Transformers

Many current transformers supply only a limited number of watt-hour meter elements with a limited number of runs. For metering and relaying applications, IEEE C57.13 has established the standard burdens as given in Figure 9.

Figure 9: Standard Burdens for Current Transformers

Standard Burdens for Current Transformers with 5 A Secondaries *					
Burden Designation †	Resistance (Ω)	Inductance (mH)	Impedance (Ω)	Volt Amperes (at 5 A)	Power Factor
Metering Burdens					
B-0.1	0.09	0.116	0.1	2.5	0.9
B-0.2	0.18	0.232	0.2	5.0	0.9
B-0.5	0.45	0.58	0.5	12.5	0.9
B-0.9	0.81	1.04	0.9	22.5	0.9
B-1.8	1.62	2.08	1.8	45.0	0.9
Relaying Burdens					
B-1	0.50	2.3	1.0	25.0	0.5
B-2	1.00	4.6	2.0	50.0	0.5
B-4	2.00	9.2	4.0	100.0	0.5
B-8	4.00	18.4	8.0	200.0	0.5

* If a current transformer is rated at other than 5 A, ohmic burdens for specification and rating may be derived by multiplying the resistance and inductance of the table by $[5/(\text{ampere rating})]^2$ the VA at rated current and the power factor remaining the same.

† These standard burden designations have no significance at frequencies other than 60 Hz.

Actual Burdens for Current Transformers

Actual devices connected to instrument transformers often include an inductor with an iron core, which usually means that the inductance is not constant but varies during the cycle, and varies differently with different currents. Exact analysis of current transformer performance with such devices is difficult. Fortunately, the impedances of most instruments and meters are sufficiently constant that no appreciable error is introduced by considering them to be constant. Many electro-mechanical relays, however, have variable impedance. Analysis of the transformer performance is usually based on an equivalent value at normal current. This can be justified on the basis that the burden at higher current is usually less and thus the current transformer will perform better than expected from the equivalent burden.

Some relays operate from two or more sources of current: differential (current-current), or power or impedance-measuring (current-voltage) relays. If the two circuits are magnetically coupled by the relay, the burden on one source is affected by the current in the other source, and vice versa. Most of the two-source relays act by balance-beam or other mechanical coupling, so that the burdens are fixed.

Standard Burdens for Voltage Transformers

The standard burdens to be used for testing and comparing voltage transformers are rated at 120 volts and at 69.3 volts. IEEE C57.13 specifies that the 120 volt-rated burden will be used for any transformer with the secondary voltage in the range of 115 to 120 volts, while the 69.3 volt burden will be used for any transformer with the secondary voltage in the range of 65 to 72 volts. This means that the actual volt amperes in the burden in a given test may be different than the nominal value of the burden in volt amperes. For instance, if the standard burden is 25 volt amperes, the actual burden when it is used for testing a transformer with 115 volt secondary is $(115/120)^2$ or .918 times the nominal value of 25.

The burdens rated 69.3 volts have an impedance only one-third of that of burdens rated 120 volts and they should not be used in testing or rating transformers rated at 115 to 120 volts. Transformers rated at 115 or 120 volts should be treated as 115 or 120 volt transformers, and if they are actually used at reduced voltage, the performance will not be different if the 120 volt burden is used as a basis for performance. This is because the performance of a transformer down to voltages of about 5% of its rating is not significantly different from the performance at 100% voltage.

Refer to Figure 10 for standard burdens for voltage transformers as outlined in IEEE C57.13.

Figure 10: Standard Burdens for Voltage Transformers

Standard Burdens for Voltage Transformers					
	Burden Designation	Volt Amperes	Power Factor	Burden Impedance	
				120 V Burden	69.3 V Burden
Metering Burdens	W	12.5	0.10	1152	384
	X	25	0.70	576	192
	M	35	0.20	411	137
	Y	75	0.85	192	64
	Z	200	0.85	72	24
	ZZ	400	0.85	36	12

Current Transformers: Accuracy Classes for Relaying

Relaying accuracy classes for CTs are defined with a “C” or a “T” classification.

“C” indicates that the transformer ratio can be calculated. These are transformers which are constructed so that the effect of leakage fluxes on its performance are negligible.

“T” indicates the transformer where the leakage flux has an appreciable effect on the ratio. Since the calculation of the excitation current by-passed is a tedious process, the performance of the transformer can only be determined by test.

The basis for classification of performance for relaying is an error limit of 10% at any current from 1.0 to 20 times normal. The accuracy class is the description of how much voltage the transformer can supply to the output circuit (burden), without the CT core going into saturation.

For example, a transformer that can supply a 2 ohm output circuit (burden) at 100 A [20 times normal current (5 A)] or 200 V, without saturating the core and within a 10% error limit, is classified as 200 accuracy class. Refer to Figure 11.

Standard accuracy classes, which may be assigned for a relaying current transformer, are 50, 100, 200, and 800. If a C200 transformer can supply 100 A secondary output at exactly 10% error into a 2 ohm burden, then the exciting branch is not over 10 amperes. If the current is lower, then the burden can be higher without exceeding the output voltage limit if a transformer can carry 2 ohms at 50 amperes and deliver 200 volts. However, if the burden is 1 ohm at 200 amperes, it will not work since the internal impedance will be significant in relation to the 1 ohm burden.

Figure 11: Accuracy Standard Chart for Class C Current Transformers

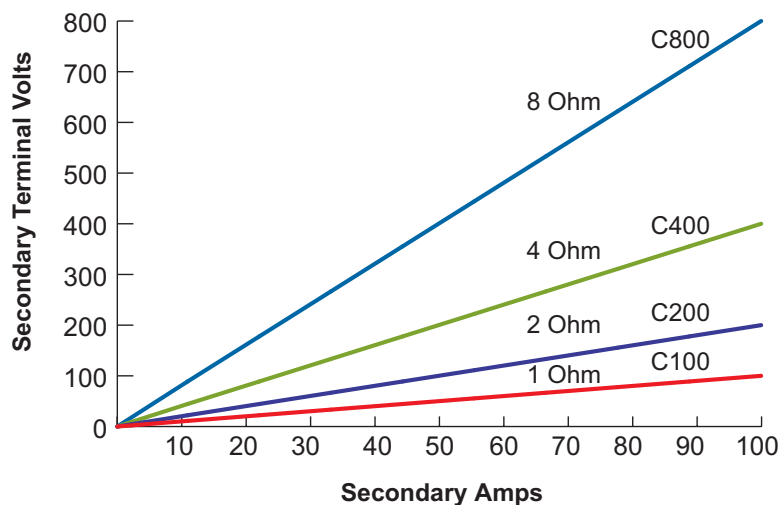

Insulation Systems

Partial Discharges in Transformer Insulation

Partial discharges (PD) are minute electrical discharges that result from the electric field stresses imposed on any insulation system. As the name suggests, they do not cause a complete electrical breakdown of the insulation, so their short term effect is not catastrophic. Over the long term, if the electric field stresses are high, PD can slowly deteriorate the quality of the insulation. In solid insulation systems (such as in instrument transformers), PD can occur where a void or discontinuity in solid insulation is introduced Figure 12. Because of the difference between dielectric properties of a void (filled with air or gas) and solid material, the localized electrical stress in the void can be higher than in a solid. This will cause a void to break down although the voltage across the solid will remain (Figure 12). These localized void breakdowns, resulting in small, high frequency current impulses, can be detected by using sensitive instrumentation. Sophisticated, specialized analysis of PD patterns can then be used to gain insight to the nature of PD, its possible location, and mitigation. PD is measured in the pico Coulombs (pC) unit of electrical charge. After many years of deliberation, different standards for different electrical equipment (ANSI, IEC, IEEE) do not consistently agree on the allowable or maximum limits of PD. Manufacturers of ITs use different ways of minimizing or controlling the level of PD:

- Control manufacturing processes (casting, curing, temperatures, vacuum, viscosities, etc.) to minimize the introduction of voids
- Develop shielding materials and techniques to minimize electric field stress enhancement
- Fill voids with dielectric gas to lower the risk of void breakdown
- Use insulation materials with similar dielectric constants for the solid insulation system

Figure 12: Partial Discharges

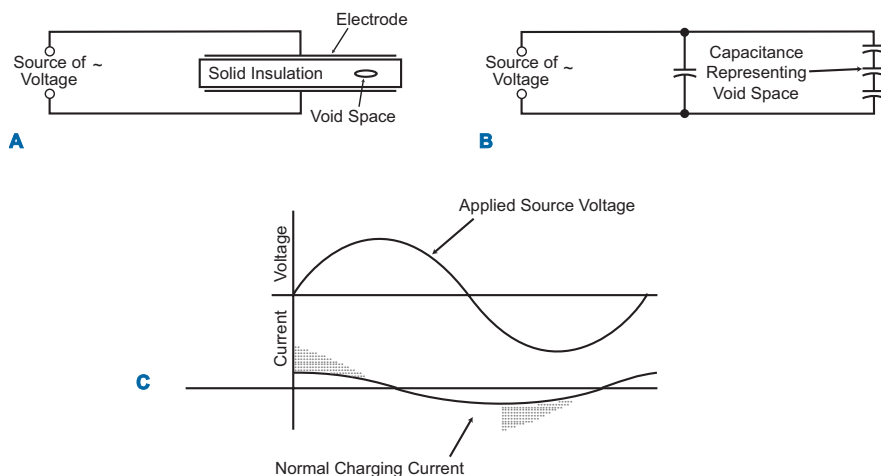

- A.** A sample of solid insulation between electrodes, which forms a capacitor, can have a void as shown.
- B.** The electrically equivalent capacitance network.
- C.** Applied voltage and the corresponding PD current caused by breaking down the void.

Overloading, Overheating and Aging

All insulation materials are deteriorated by the combination of overheating and exposure to moisture, oxygen in air, and UV radiation in outdoor conditions. ABB insulation systems are designed to withstand degradation caused by all of these environmental factors.

IEEE Standard C57.13 recognizes two classes of insulation insofar as resistance to temperature is concerned: (a) 55°C temperature rise and (b) 80°C rise, both over a 30°C daily average ambient temperature. These values are the average temperature rise of the winding (as measured by rise of resistance) during the temperature test at rated maximum continuous current. The Guides for Loading recognize that these temperatures can be considerably exceeded for short periods of time without causing excessive deterioration of the insulation (reference Section 10 of IEEE C57.13).

Maintenance and Inspection Testing of Insulation

Instrument transformer users routinely test new transformers, as well as transformers in service, to ensure their adequacy for service. It is rarely possible for the end user to run complete series of tests, but there are some things the user can do for reassurance.

Measurement of the resistance of each winding to ground (when one winding is measured, ground all other winding terminals) with a megger will indicate if something has happened to reduce the resistance values. Such an incident is most improbable on encapsulated transformers. All ABB insulated current and voltage transformers should have typical readings from the high voltage winding to the low voltage winding, and ground above 1 Megohm per volt at 25°C.

Insulation resistance should be measured at ambient temperature (not over 30°C) because it decreases rapidly at higher temperatures.

Voltage Ratings

Current transformers are always rated at the line-to-line voltage of the three-phase system on which they will operate. A 13.8 kV current transformer, for example, is designed for use on a 13.8 kV three-phase system. The actual voltage from the current transformer primary winding to ground is only $13.8/\sqrt{3}$ or 7.9 kV as shown in Figure 13.

Voltage Ratings for Current Transformers

In the Transformer Standards IEEE C57.13, an insulation class, which has the appearance of a system voltage rating, is associated with each of the standard arrays of dielectric tests (60 Hertz and impulse voltage). It has become standard practice to apply transformers on systems with actual voltage higher than the insulation class value. This is done on the basis that if the power system is designed such (grounded, usually) that the line-to-ground voltage can never be more than 70% or 80% of the line-to-line value, lower-voltage-rated lightning arresters can be used and the insulation is protected from all the higher voltages to which it might otherwise be subjected.

The transformer test voltages consist of a full wave impulse, chopped waves, 60 Hertz applied, and induced voltage test according to the schedule outlines in IEEE C57.13

Figure 13: Equivalent System Diagram

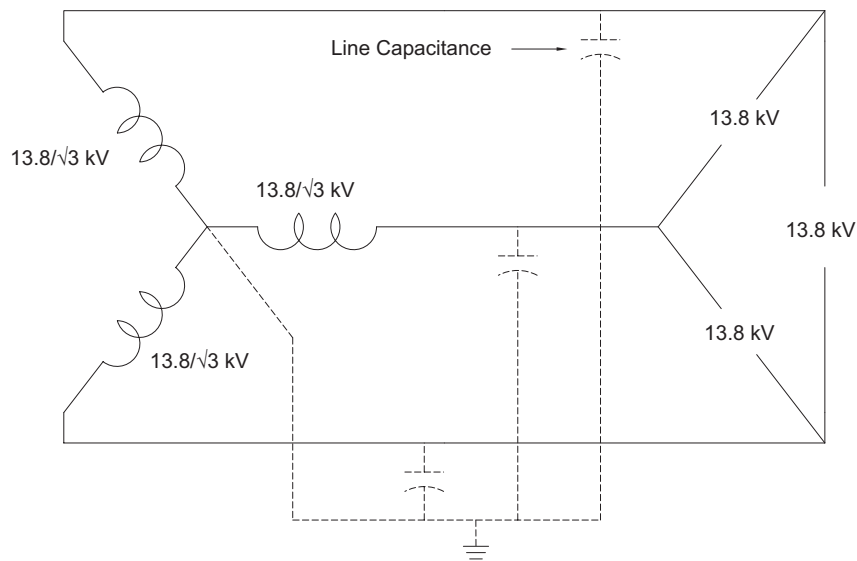

Whether or not this neutral is actually connected to ground, the natural symmetry of the circuit and the equal line capacitors to ground will cause the neutral to assume ground potential.

Voltage Ratings for Voltage Transformers

The voltage which may be applied to a voltage transformer is limited not only by the permissible voltage to ground (as it is in a current transformer) but by the insulation between turns, between layers, and coil sections. It is also limited by the ability of the core to carry enough magnetic flux to induce the voltage. The voltage transformer is somewhat different from the distribution transformer, and certainly from the power transformer, in having a very limited capacity to store energy.

Over Voltage Limits

IEEE C57.13 recognizes five groups of voltage transformers for different capabilities and connections. These groups are explained by Figures 14 through 18.

All transformers, according to IEEE C57.13, are capable of operating continuously, and of maintaining their accuracy at 110% of rated voltage. As indicated in the figures, Group 2 transformers need do no more than this, and Group 1 transformers must be able to operate (but not necessarily maintain accuracy) at 125% voltage during emergencies, while Group 3 and 4 transformers must be able to operate for one minute at line-to-line voltage, which is $\sqrt{3}$ times their rating. Group 5 must be able to operate (but not necessarily maintain accuracy) at 140% voltage for one minute.

Figure 14: Application Limitation - Group 1 Voltage Transformers

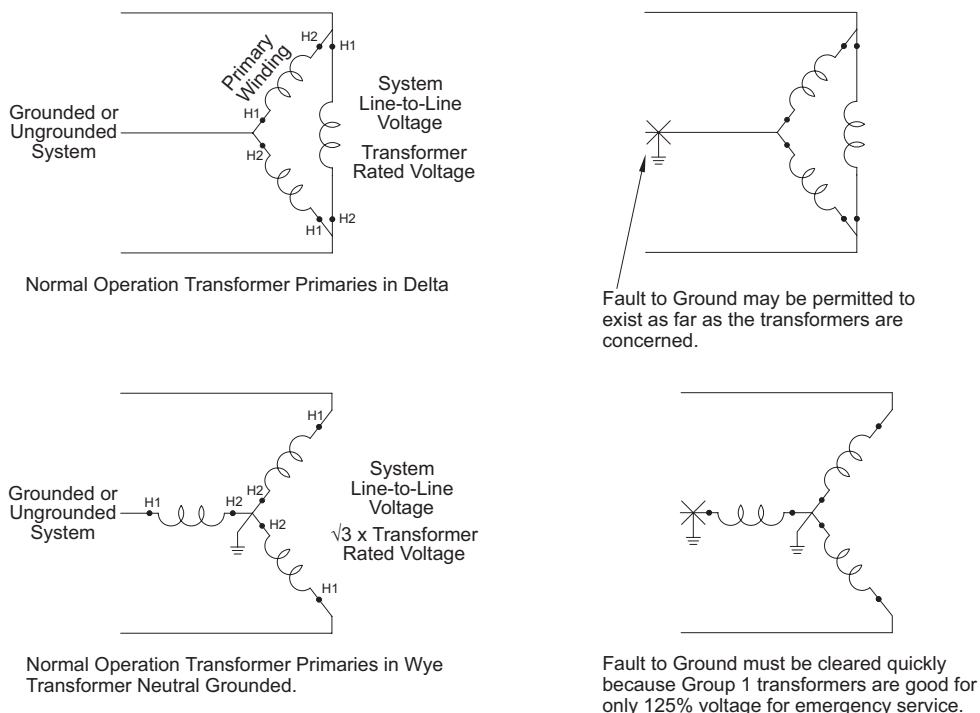

Figure 15: Application Limitation - Group 2 Voltage Transformers

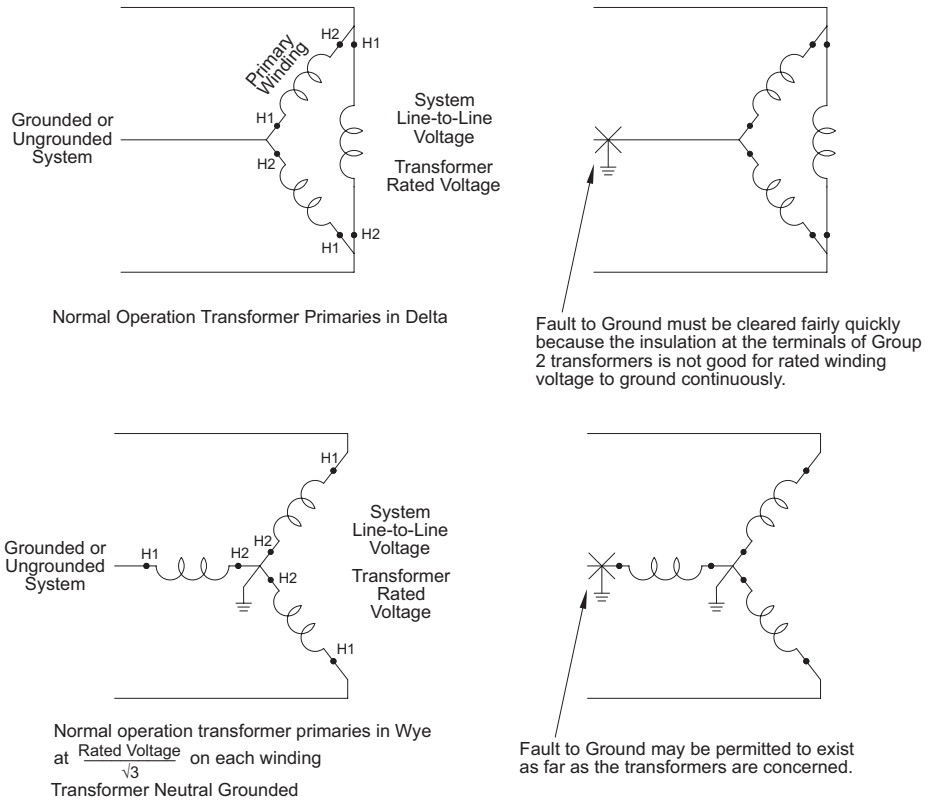
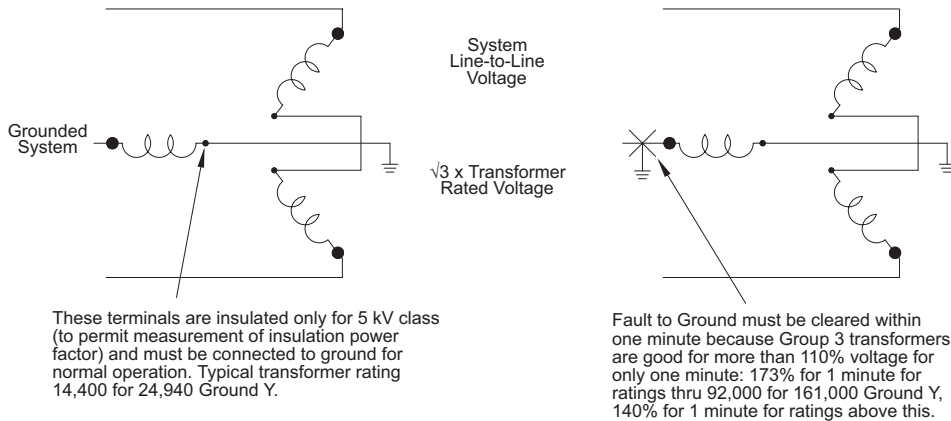

Figure 16: Application Limitation - Group 3 Voltage Transformers



These transformers have two secondary windings, one with a rating of 115 volts (except for the lowest rated 14400 for 25000 ground wye which is rated at 120 volts) and another secondary winding rated at approximately $115 \text{ V} / \sqrt{3}$. The value is not always exactly $115 \text{ V} / \sqrt{3}$ because, for simplicity, the primary/secondary voltage ratio is adjusted to a round number.

Figure 17: Application Limitation - Group 4 Voltage Transformers

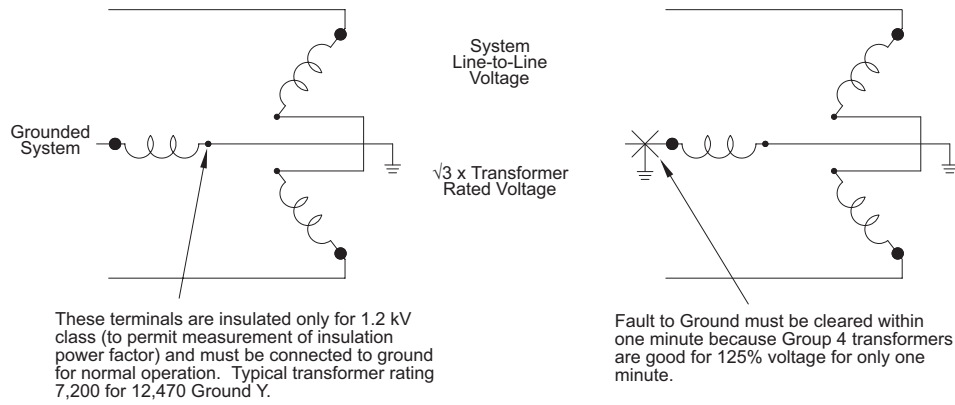
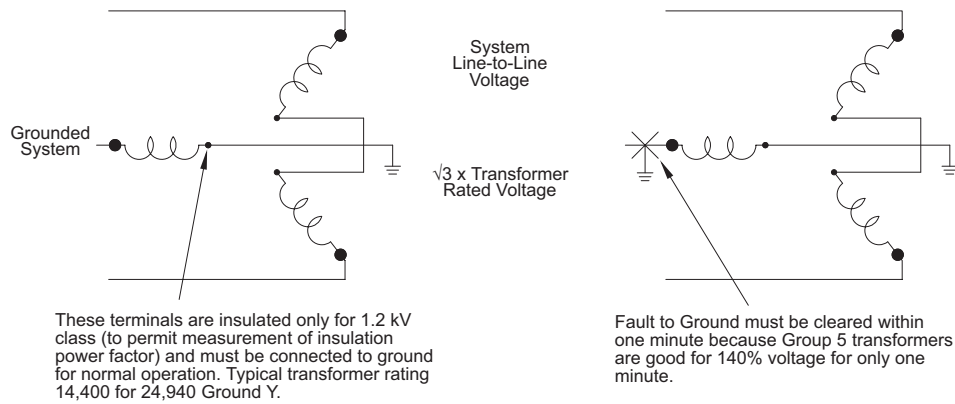

Figure 18: Application Limitation - Group 5 Voltage Transformers



Power Quality

Power quality is an important consideration in designing any power system. Distribution systems are especially vulnerable to power quality problems. These problems should be taken into account when selecting and purchasing equipment. Distances for power delivery, density of loads, and customer concentrations are among the aspects that differ between the US ANSI market and the European IEC market. Power quality problems include:

- voltage sags and dips
- momentary interruptions (flicker)
- harmonics (harmonic current and/or harmonic voltages)

Voltage Sags and Dips

Voltage sags and dips are associated with switching or fault events in the power system that cause voltages on adjacent or neighboring circuits to partially collapse. These events can last from a few milliseconds to more than a second.

Momentary Interruptions

Momentary interruptions are the same type of power system events as voltage sags and dips, but are caused by lightning and other transients. The primary difference is that momentary interruptions occur primarily in the circuits directly involved in the event rather than in an adjacent circuit. Momentary interruptions are more severe power quality problems than voltage sags and dips.

Figures 19A & 19B show statistics of voltage sags and momentary interruptions in a typical ANSI power system.

Figures 19A and 19B: Distribution of RMS Events

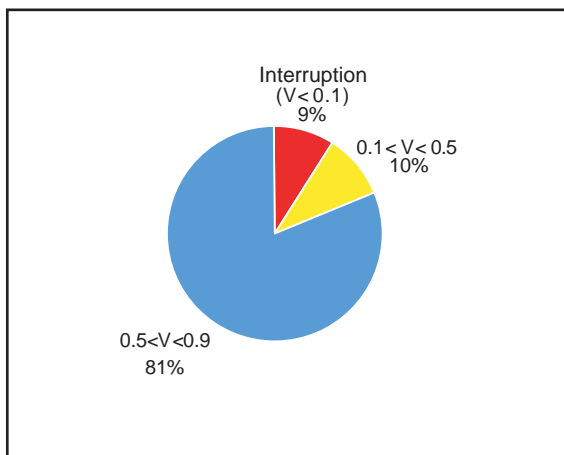

19A. Pie-chart showing the statistics of voltage sags and interruptions. Note most events (81%) are sags (between 0.5 pu and 0.9 pu).

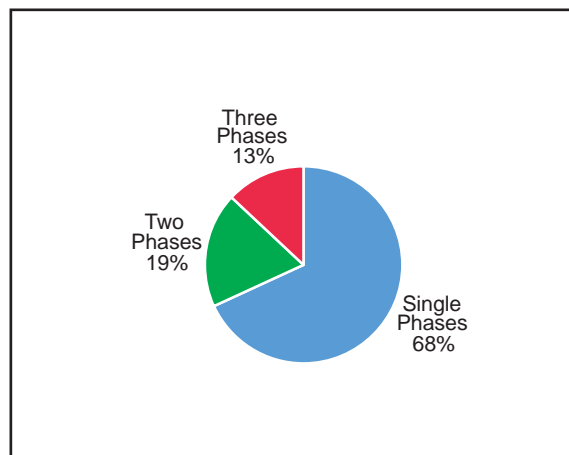

19B. Pie-chart showing the statistics of all power quality event types. Note most events (68%) are single phase.

Harmonics

Harmonics are caused by non-linear loads. The nature of non-linear power equipment causes a perfectly sinusoidal voltage waveform to result in currents containing other frequencies. A sinusoidal current can cause the generation of non-sinusoidal voltages. Non-linear power equipment includes saturated transformers, motors, and generators, but is primarily associated with power electronics. The act of triggering or switching a Silicon Controlled Rectifier (SCR), a diode, an Insulated Gate Bipolar Transistor (IGBT), or a Gate Turn-Off device (GTO), is in principle a non-linear operation. Power electronics devices such as Adjustable Speed Drives (ASDs), or Variable Speed Drives (VSDs) can exhibit a high level of harmonics, often more than 100% Total Harmonic Distortion (THD). In the case of ASDs, this level of harmonics varies with the selected rpm of the motor, and mechanical load on the shaft.

Harmonics are unwanted events in distribution systems. They can cause excessive heating and damage to neutral connections and cables, and can saturate instrument transformers. Harmonics may also precipitate from the original location of the non-linear equipment to other locations like feeders and loads. They also may cause false tripping or malfunctioning of equipment, false readings from the CTs and VTs especially sensitive relays, computer loads, other ASDs, and Programmable Logic Controllers (PLCs).

There are a variety of techniques to mitigate and control the level of harmonics, and industry standards regulating harmonics (see IEEE 519, Standard Practices and Requirements for Harmonic Control in Electrical Power Systems, or IEC 555/1000-3). Possible mitigation procedures include reconfiguring the system, re-sizing the cables or transformers to include additional loading due to harmonic currents, or installing filters and harmonic blockers. It is important to remember that these measures work for some, but not for all harmonics. Often a comprehensive study has to be performed to determine the level of harmonic currents, their impact on the power system, and possible suppression measures.

In real systems, one disturbance in the system can cause a cascade of other disturbances. For example, a lightning surge (fast overvoltage transient) traveling along an overhead feeder line can cause a flashover and subsequent short circuit in a substation supplying an industrial plant, which in turn can cause abnormal acceleration of a local generator and so on.

Service Conditions

Overload and Short Circuit Capability

A voltage transformer is connected across the line or line-ground, and is loaded to a greater or lesser degree depending on the number of devices connected in parallel at the secondary terminals (Figure 20). As the load is increased, the curves for ratio error and phase angle will show how the accuracy is affected.

If accuracy is not important, the load can be increased to the thermal volt-ampere rating, the maximum which can be carried without overheating. Voltage transformers must be able to withstand an accidental short circuit for one second.

A current transformer's primary is connected in series with the line and must carry whatever current flows in the line. The burden impedance connected to the secondary terminals affects the accuracy, as shown by the curves for ratio error and phase angle, but generally has no significant effect on temperature.

Because watt-hour meters are usually capable of carrying at least 400% of rated current continuously, many of those current transformers used almost exclusively with watt-hour meters have been designed specifically to carry two to four times normal current. Also, because many of those current transformers are used almost exclusively in enclosed switchgear, they must be designed to operate in a high ambient temperature (55°C), they will carry 1.33 times normal current in a normal (30°C daily average) ambient temperature. The factor designating the continuous current capacity in terms of rated current at 30°C ambient is called thermal current rating factor. Standard values are 1.33, 1.5, 2.0, 3.0 and 4.0. The continuous thermal rating factor is based on 30°C average ambient temperature unless otherwise noted.

The IEEE Guides for Loading recognize that transformer insulation can withstand a considerable degree of overheating for a short time without severe deterioration. For example, in the event of a line short circuit, the fault current may easily be fifty times the rated current of the current transformer, but will probably flow for not over one second. IEEE C57.13 permits a 250°C temperature for this very short time (compared to 95°C average continuous winding temperature). All current transformers are assigned a one-second thermal current limit which denotes how much current they will carry (usually denoted in terms of times normal rated current) for one second. For durations up to five seconds, current transformers will carry currents lower than this.

The transformer will carry more current for a time less than one second according to the same rule, up to the mechanical current limit (which is also given for standard current transformers.) At this limit of current, the electro-mechanical forces tending to separate the primary and secondary coils, become high enough to damage the transformer.

The mechanical current limit is specified in terms of times normal rated current, as is the thermal one-second limit, but it is always assumed that the current may be fully offset initially. If it is known that the current cannot be initially fully offset, the current transformer will be able to withstand mechanically a larger RMS value of current, larger than its rated mechanical limit.

The temperature at these high currents and short times (less than five seconds) cannot be measured, but is always calculated on the basis that all heat generated by the current is stored in the copper for the duration (not over five seconds) of the high current.

Currents higher than the rated value, but less than the five second limit, can be determined by the rules set forth in the IEEE Guides for Loading. The calculation for any given transformer is lengthy, and as a general guide for standard transformers, the curves of Figure 20 can be used.

Figure 20: Overload Capability of Current Transformers

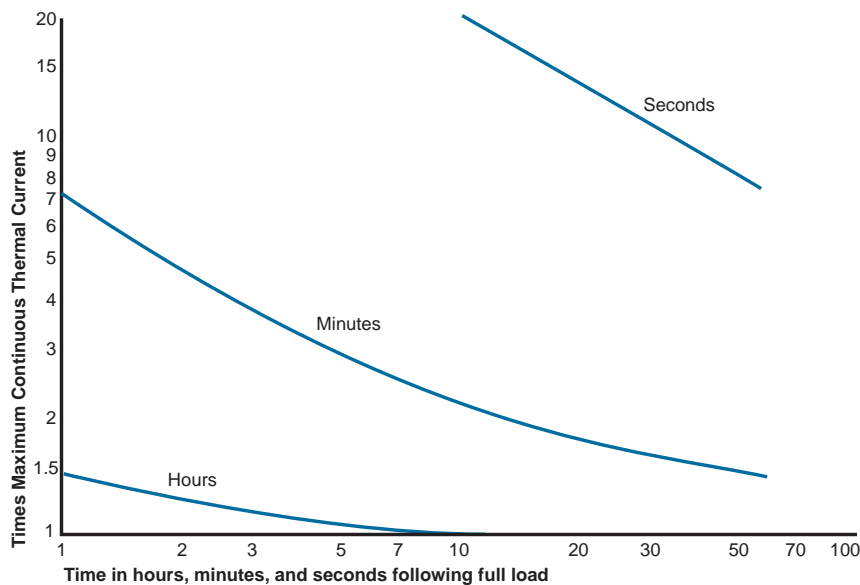

Recommended guide for short time loading of current transformers following rated load for 0.1% loss of life. Transformers so loaded will reach temperatures in excess of 55°C rise over ambient. Loading according to this curve is not safe if the ambient exceeds 30°C on the average, or if the overload occurs more often than once a day.

Higher and Lower Ambient Temperatures

At temperatures over the standard 30° C, daily average ambient temperature current transformers should be derated 1% for each degree over (up to 55°C ambient). At temperatures under 30°C, they may be uprated 0.75% for each degree (down to 0°C). Special application CTs are available where bus bar temperature is as high as 135°C (refer to Figure 21).

Figure 21: 55°C Rise Current Transformer Thermal Loading Guide

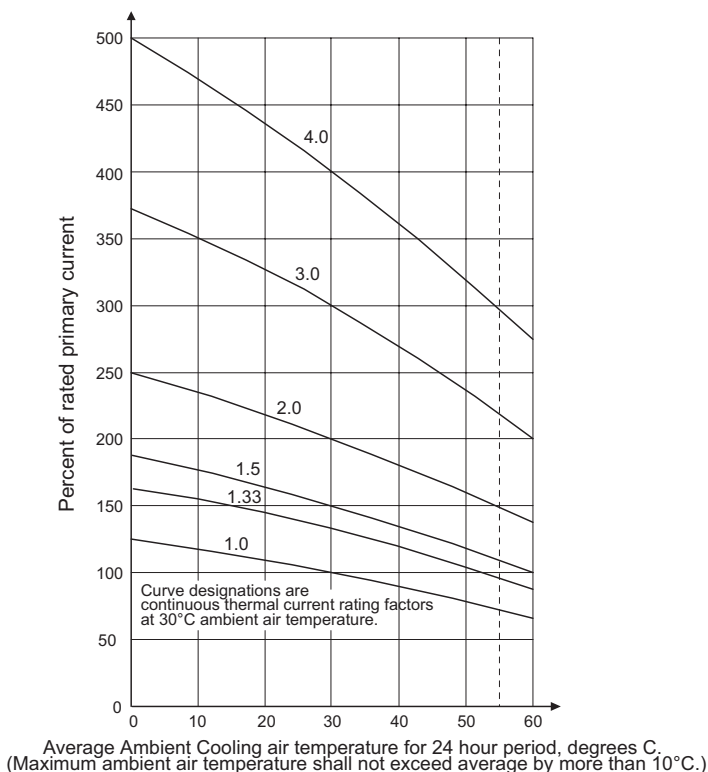

Open-Circuit Voltage in Current Transformers

Figure 2 (page 5) shows that the line current must flow through the current transformer, and Figure 4 (page 8) shows that if the secondary circuit is accidentally opened, all the current will have to pass through the exciting current branches of the equivalent circuit. This will develop a high voltage across the exciting branch, which will appear as a high voltage at the secondary terminals. Because this voltage is limited by saturation of the core, the RMS value measured by a voltmeter may not appear to be dangerous. As the current cyclically passes through zero, the rate of change of flux at current zero is not limited by saturation, and is very high indeed. This induces extremely high peaks or pulses of voltage.

These high peaks of voltage may not register on the conventional voltmeter, but they can break down insulation and are dangerous to personnel. Current transformers are insulated to withstand, for emergency operation, secondary peak voltages up to 3500 volts. This takes care of the smaller transformers with relay accuracy class under T200, but if open-circuit of larger transformers is probable, some protective circuit should be permanently connected to the secondary terminals. In general, open-circuit of the secondary terminals should be considered as a serious accident.

The actual open-circuit voltage peak is difficult to measure accurately because it exists only as very short peaks. The method outlined in the Test Methods Section of IEEE C57.13 represents an excellent compromise between precision and feasibility.

Permanent Magnetization of Current Transformer Cores

If a system short-circuit occurs, with a current of several times normal, the voltage at the burden may be rather high. The flux density in the equivalent exciting reactance (the core of the current transformer) may be high enough that if the fault current is abruptly interrupted, the core may be permanently magnetized at a fairly high flux density. This is often referred to as residual magnetization.

If the secondary circuit of the current transformer is accidentally opened, the flux density will become very high and even if the circuit is immediately closed again, the core may be left with permanent magnetization.

When normal current and flux variation is restored, the flux variation starts from the residual value and varies as shown in Figure 22. If the flux starts to increase from point a, the flux variation cannot be maintained in loop a-A in Figure 22, because such a loop would require direct current to maintain it in its offset position. The flux loop must shift down to the symmetrical (around the vertical axis) loop c-C. As it shifts down it actually generates a small direct current in the secondary circuit. The secondary burden will establish the rate of change. The flux variation will stay in this loop indefinitely.

The slope of the loop c-C will be less than the slope of the normal, completely symmetrical loop at the origin. The peak exciting current S_1' will be higher than the normal exciting current S_1 . If the alternating flux density increases, the hysteresis loop moves to d-D and the slope of this loop becomes nearly equal to the symmetrical loop. The exciting current S_2' is still greater than the symmetrical value, but not as much greater in percent, as the difference between S_1' and S_1 .

The final result is that the effective exciting current, which causes ratio error and phase angle, is increased if the core becomes permanently magnetized. This will usually cause no more than 0.1% and 3 minutes of additional error in practical metering transformers at metering burdens¹⁰. The difference is less dependent on burden and current than might be expected. This is because the increase in exciting current from permanent magnetism is less at low flux variation, and moves to a constant ampere-turn value as the flux variation increases.

If precision measurement of ratio and phase angle is important, especially if ratio and phase angle measurements made at different times or in different laboratories are to be compared, demagnetization of the core by the conventional method of applying an alternating voltage high enough to circulate rated current in the secondary winding, reducing it gradually to zero, is desirable. (See IEEE C57.13).

10. At 100% current

Figure 22: Permanent Magnetism in Current Transformers

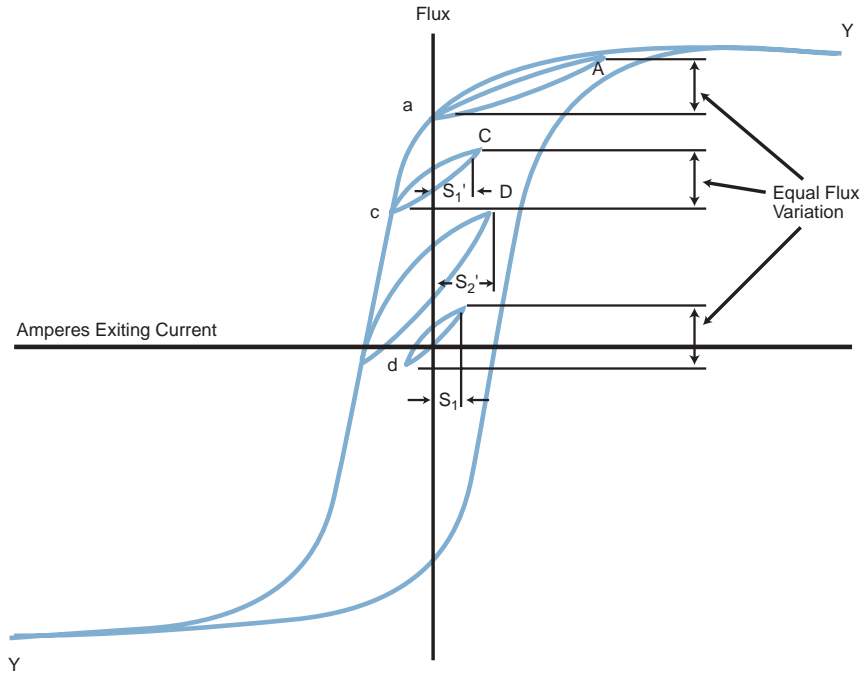

To allow loop a-A to exist, a direct current must flow, requiring a DC voltage. This in turn requires a downward change in flux to induce it, with the result that the loop shifts down to c-C which is symmetrical about the vertical axis and requires no direct current. Operation is stable over this loop. The iron is permanently magnetized by having been at point a, and the loop c-C will not of itself shift down further. Imposition of a still higher AC flux variation will cause the larger loop d-D, shifted down from c-C. A very high flux density will restore the original symmetrical loop y-Y.

Voltage Transformer Connected Line-to-Ground on an Otherwise Ungrounded System

An ungrounded system is always actually grounded, although perhaps very poorly, by the capacitance and resistance of its insulation-to-ground, as shown in Figure 24. If a voltage transformer is connected from one line-to-ground it is, in effect, connected in parallel with a capacitor. The equivalent circuit is shown in Figure 24. Figure 24 also shows how parallel resonance can occur between transformer and capacitor, and how it can cause a very high voltage with destruction of the voltage transformer. If examination of a voltage transformer which has failed, shows only the primary winding uniformly roasted from end-to-end, gross over-excitation is undoubtedly the cause and “ferro-resonance” can be suspected. It is called ferro-resonance because this resonance depends on partial saturation of an iron core.

The number of combinations of constants which can cause ferro-resonance is large, and the analysis of the circuit and prediction of possible destructive voltage is not simple. For ABB transformers of present and foreseeable future manufacture, this works out as shown in Figure 23.

These high loadings may cause errors greater than 0.3%, but transformers connected line-to-ground on an ungrounded system are rarely used for metering in the ANSI market (units connected line-to-line are more common). If three transformers are connected in Y on the primaries, the secondaries should never be connected in Delta.

Figure 23: Watt Loading - Ferro-resonance Prevention

Voltage Class (Primary)	Watt Loading on Secondary to Prevent Ferro-resonance	Approximate Ohms Equivalent Resistance per Phase (120 V)	Connected Across Corner of Broken Delta
To 500	200	72	216
7200-15000	500	29	87
25000 and up	750	20	60

Figure 24: Ferro-resonance Voltage Transformers

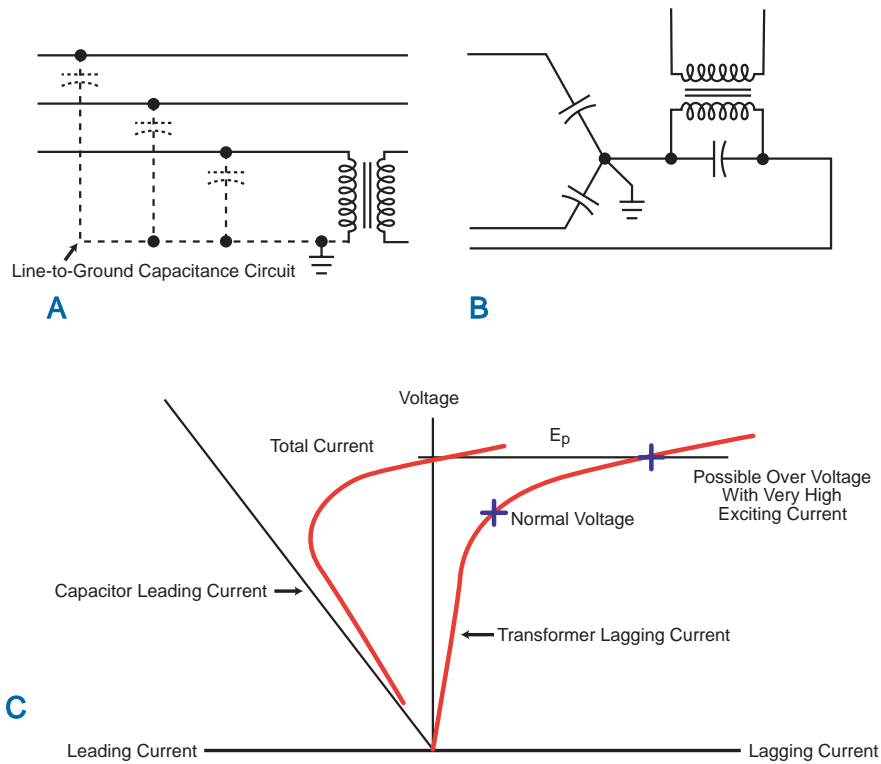

- A.** Line-to-ground capacitance circuit
- B.** Equivalent Y circuit
- C.** Approximate possible curve of current (neglecting resistance components) showing that at some particular value of voltage (E_p) the capacitor and transformer's reactive current total zero, representing infinite impedance, with the result that the voltage-to-ground on this line may reach E_p . This is a high enough value that excessive exciting current will burn out the primary winding.

Auxiliary Current Transformers



Many circuit problems can be solved by connecting one current transformer to supply another current transformer, usually called an Auxiliary current transformer, shown in Figure 25.

Auxiliary current transformers perform like other current transformers, but there are certain problems associated with their use which merit discussion.

First, the auxiliary current transformer constitutes an additional burden on the main current transformer, which usually increases the errors of the main current transformer.

Second, the performance of auxiliary current transformers is not usually as good as the performance of main current transformers. This is because the auxiliary current transformer is designed to impose as small a burden as possible on the main current transformer. This means its own burden capacity must be relatively low.

These two considerations mean that the errors of transformation, when an auxiliary current transformer is used, will typically be three times the value which might be expected with a single transformer. However, the special functions which can be performed by the auxiliary current transformer, as indicated in Figure 25, often dictate their use.

Figure 25: Auxiliary Current Transformers

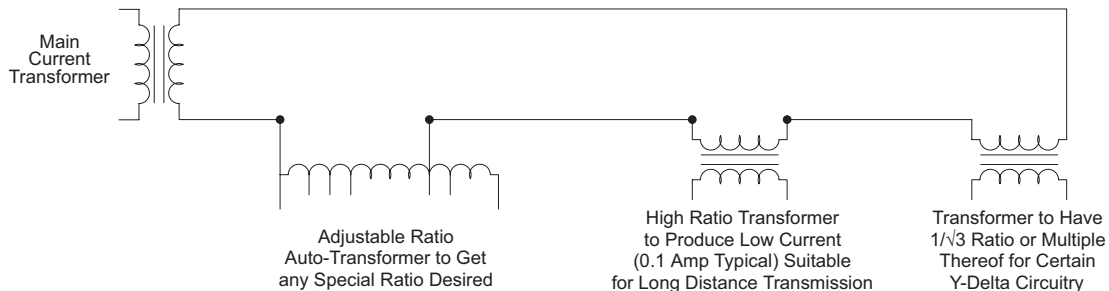

Fusing Voltage Transformers



Primary fuses are primarily used with voltage transformers to take the transformer off the line in the event of an internal failure. This prevents a failed VT from becoming an L-G fault, which requires the breaker to interrupt the customer's electric service.

Since modern transformers are much more reliable than older ones, the fuses may never operate due to internal transformer failure. Transformer failure may still be caused by overload or short circuit on the secondary, however. If such failure occurs it may involve other apparatuses, perhaps causing an outage.

Modern fuses are more substantial and reliable than older fuses, so the chance of fuse failure is minimized. Only the exceptional installation will be so dependent on continuity of voltage that the transformer must be connected solidly to the primary circuit. With modern fuses, the principal disadvantages are the cost of fuses and mounting and the space they require.

Most primary fuses will also protect the transformer against partial short circuit in the primary winding and against secondary short circuit. Some operators choose fuses which will not operate on secondary short circuit conditions.

All voltage transformer fuses will interrupt only a certain maximum fault current, therefore current limiting fuses are utilized. These current limiting fuses have higher interrupting ratings and can, in most cases, be used without external resistors to limit the current.

Primary fuses may be mounted on indoor transformers at the factory or they may be in separate mountings. Generally, separate mountings increase the cost and the space required for installation.

Whether to use fuses or not is determined by the operator's established practice, but operation without fuses has proven satisfactory in the majority of installations. The same considerations apply for outdoor transformers, but separately mounted fuses in their own mountings must be used. They are not mounted on the transformer.

The use of secondary fuses is relatively rare and is a matter of personal choice with the operator. Such fuses should be rated so that they will carry the secondary current indicated by the thermal VA rating of the transformer, but should fault in a short time at any higher current to protect the transformer. If mechanical failure of a fuse occurs and is not quickly detected, a considerable loss of revenue or protection may occur.

New Design Technologies

Cost-effective, highly reliable electrical equipment is the result of a design process that combines optimized electrical and mechanical design features, efficient use of the best insulation material available, and highly refined manufacturing processes. This innovative approach is used on the next generation of ABB instrument transformers.

Advanced Design Technologies

Wider availability of advanced simulation software has provided engineers with many tools to develop new products and associated tooling without incurring large prototyping expenses.

In the next generation design of instrument transformers, ABB uses Ansoft's Maxwell[®] 3D electrostatic simulation software. This program calculates electric field stress distribution on the surface and inside the cast electrical device. For each insulation material candidate, different field stress distribution is obtained depending on the dielectric properties of the material. Furthermore, the engineers can vary the conditions of the environment outside the simulation model to obtain field stress distribution specific to the environment.

The 3D-based design features are then imported into an ABB-proprietary software package (Reactive Molding RAMZES). This program optimizes the casting process and parameters, and calculates the resulting mechanical stresses and strains that develop inside the casting. Optimum mechanical robustness can be designed into the product through the variations of these casting parameters.

New Material Technologies

To yield the most reliable and affordable transformers, hydrophobic cycloaliphatic epoxy (HCEP) was configured into the electrostatic simulation model for product optimization.

HCEP was developed by a global epoxy supplier using a proprietary formulation and special processing techniques to produce an improved outdoor epoxy. It sustains surface hydrophobicity better than its cycloaliphatic (CEP) counterpart upon prolonged exposure to aggressive outdoor environments, without sacrificing other desirable chemical and mechanical properties. (The advantageous characteristics of hydrophobic insulation surfaces have been previously discussed in the Technology Review section.) The resulting outdoor equipment possesses the following attributes:

- Improved weatherability and outdoor aging
- Better performance in heavily polluted environments
- Enhanced reliability and life expectancy of the product

New Process Technologies

In the early stages, a vacuum-encapsulating process was most commonly used for epoxies. This more forgiving process eliminated the costly mechanical reinforcement of the core-coil assembly as required with the high pressure molding of butyl rubber. During the 1980's, liquid injection casting of epoxies was introduced. The process was further automated and called automatic pressure gelation (APG). The APG process effectively shortens the encapsulating cycle time and has become the process of choice for epoxies.

The best design utilizing the best material still does not guarantee a reliable and long-lasting performance if it is not properly manufactured.

Although the APG process has been applied to epoxy casting for many years, the large window of casting parameters such as temperature, pressure, and curing time still presents a great challenge on how to optimize the process to obtain a superior product. A trial and error approach is one way, but this leads to high prototyping costs and considerable evaluation time.

As previously mentioned, the use of advanced simulation software (RAMZES) greatly shortens this exercise and allows engineers to efficiently optimize the casting process. When the APG process is coupled with the latest resin handling, mixing, and process control technologies, the result is a reliable, robust, and cost-effective product.

New Sensing Technologies

Parallel to the instrument transformers, the new techniques of measuring voltage and current are becoming commercially available.

Voltage Sensing

Resistive voltage dividers are becoming a commercially viable alternative to measuring voltage. Although they draw slightly larger (resistive) current, they can be embedded in a cast of solid dielectric material (such as epoxy or polyurethane) and provide a stable output in a wide frequency range, including high order harmonics. The voltage from the resistive divider is equal to:

$$V_{SEC} = V_{PRI} * \frac{R_{SEC}}{R_{PRI} + R_{SEC}}$$

Capacitive voltage dividers have been in high voltage testing for a long time. They provide a stable output proportional to the ratio of capacitances.

$$V_{SEC} = V_{PRI} * \frac{C_{PRI}}{C_{PRI} + C_{SEC}}$$

Capacitive voltage dividers have very high inherent impedance so they have to be connected to a high-impedance (light) burden. With the advancement of electronic relays and meters, this is becoming a commercially viable option for some applications.

Optical voltage sensors are available for high voltage applications where the insulation line-to-ground is a major concern. Optical voltage sensors are based on the electro-optical phenomenon called Kerr effect by which a light-wave is polarized depending on the electric field generated by the voltage in the system. The technology is available to be used in distribution systems as well, but some improvements in cost and complexity of the optical systems are still needed.

Current Sensing

Rogowski coils or linear couplers are essentially air-core transformers that use a power conductor as a primary winding, and an air-core coil wrapped around it as a secondary. The difference is that the primary current induces a secondary voltage signal in the Rogowski coil (not a current), which is a proportional derivative of the primary current dI/dt . This requires some careful processing of the dI/dt signal to convert to the true measurement of the primary current. Again, with the advancement of the electronic signal processing, these devices are now commercially available. Rogowski coils are very linear and do not saturate, even under extreme current conditions and high frequencies.

Magneto-optical phenomenon, called Faraday's effect, can be used to measure the current as well. When polarized light passes around the conductor with the current, the magnetic field associated with the current changes the polarization angle of the light. The change can be measured optically and converted to the electrical signal, proportional to the primary current. Optical transducers are inherently good for very high voltages since they do not require any electrical connection to the primary phase conductors. The devices are linear over their entire current range.

Product Description

General Description	38
Contemporary Design	39
Indoor Medium Voltage	39
Outdoor Medium Voltage	39
600 V Indoor (Plastic Case)	40
600 V Indoor/Outdoor (Thermoplastic Rubber (TPR))	40
Bushing Current Transformers (BCT)	40
Summary	40

General Description

ABB offers a complete line of instrument transformers from 600 V to 34.5 kV. In the 600 V class, ABB manufactures current transformers (CTs) and voltage transformers (VTs), using both thermoplastic rubber and plastic casings. In the 5 to 34.5 kV classes, ABB provides a wide range of indoor CTs and VTs cast in polyurethane, using a state-of-the-art casting process. The outdoor medium voltage CTs and PTs are cast in HCEP (hydrophobic cycloaliphatic epoxy) using an automatic pressure gelation process. Specialty items such as linear couplers and bushing-type CTs are also offered.

ABB instrument transformers are manufactured in Pinetops, North Carolina. The Pinetops operation began in 1978 and is considered a worldwide center of excellence for instrument transformers. The operation is widely recognized for its success in on-time deliveries, short lead-times, focus on quality, and customer responsiveness. On-going operations initiatives include the following:

- Customer responsiveness
- Focused factory
- Investments in new equipment
- Productivity improvement
- Inventory reduction
- Manufacturing cycle time reduction
- Front-end optimization

Transformers are built to a number of specifications, including ANSI, IEEE, CSA, IEC, and Australian. ABB-Pinetops received ISO-9001 certification from UL on November 29, 1995, and ISO-14001 certification on August 31, 2000.



Contemporary Design

The ABB instrument transformer family of products consists of the following:

- Indoor Medium Voltage (polyurethane)
- Outdoor Medium Voltage (HCEP)
- 600 V Indoor (Plastic Case)
- 600 V Indoor/Outdoor (Thermoplastic Rubber)
- Bushing Current Transformers

Voltage ranges are defined as low voltage under 700 V and medium voltage 1.2 kV through 36 kV.

Indoor Medium Voltage

Indoor medium voltage transformers are encapsulated in polyurethane using a vacuum casting process. Current and voltage transformers are available in voltage classes ranging from 5 kV to 34.5 kV. Typical applications include switchgear and metalclad enclosures for primary and revenue metering and protection.

Voltage units are available for line-to-line applications, designated by Y, and for line-to-ground applications, designated by GY.



Outdoor Medium Voltage



Outdoor medium voltage transformers are encapsulated in hydrophobic cycloaliphatic epoxy (HCEP) using the automatic pressure gelation (APG) process. Current and voltage transformers are available in voltage classes ranging from 5 kV to 34.5 kV. These units are typically used by utilities in substations.

Voltage units are available for line-to-line applications, designated by Y, and for line-to-ground applications, designated by GY.

Product Description

600 V Indoor (Plastic Case)

Plastic case 600 V window-type current transformers are offered in a variety of internal window diameters and are used in various switchgear and outdoor vacuum breaker applications.



600 V Indoor/Outdoor (Thermoplastic Rubber (TPR))

TPR 600 V transformers are available in both current and voltage designs. They are suitable for use in a variety of applications including secondary revenue metering.



Bushing Current Transformers (BCT)

BCT units are 600 V class ring-type current transformers. They can be wrapped with polyester tape or encapsulated in polyurethane. Typical applications include high voltage circuit breakers and power transformers.



Summary

A number of considerations are involved in selecting proper instrument transformers. Many of the transformer types have similar characteristics, but each type has its own unique combination of features that best meet the application for which it is designed. For more specific information, please refer to the descriptive bulletins which can be found at www.abb.com/mediumvoltage or contact your ABB sales representative.



ABB Inc.
3022 NC 43 North
Pinetops, NC 27864
Tel: +1-252-827-3212
www.abb.com/mediumvoltage