

2TMD042300D0005 | 12.08.2025

Product manual

Busch-Welcome® IP

H8304-03 IP Actuator



1	Notes on the instruction manual	4
2	Safety	4
3	Intended use.....	4
4	Environment	5
4.1	Busch-Jaeger devices.....	5
5	Product description.....	6
5.1	Device type	6
5.2	Terminal description.....	7
6	Technical data	8
7	Mounting/Installation	9
7.1	Requirement for the electrician	9
7.2	Mounting	10
8	Commissioning.....	11
8.1	Topology	11
8.2	Adding devices.....	13
8.3	Accessing the setting screen	15
8.4	Basic information.....	16
8.5	Configure mode.....	17
8.5.1	Pre-configuration mode	18
8.5.2	Semi-automatic configuration mode	22
8.5.3	Manual mode	27
8.5.4	Editing the existing configuration	31
8.6	Parameter settings	32
8.6.1	Relay status for authorization	32
8.6.2	Authorization time out.....	33
8.6.3	Relay hold time for calling elevator.....	34
8.7	Updating the firmware	35
8.7.1	Updating the firmware via local PC	35
8.7.2	Updating the firmware via website.....	37
8.8	Commissioning multiple devices in batches	38
9	Cyber security	40
9.1	Disclaimer	40
9.2	Performance and service	40
9.3	Deployment guideline.....	41
9.4	Upgrading	41
9.5	Backup/restore	41
9.6	Malware prevention solution	41
9.7	Password rule	41
10	Notice	42

1 Notes on the instruction manual

Please read through this manual carefully and observe the information it contains. This will assist you in preventing injuries and damage to property and ensure both reliable operation and a long service life for the device.

Please keep this manual in a safe place. If you pass the device on, also pass on this manual along with it. Busch-Jaeger accepts no liability for any failure to observe the instructions in this manual.

2 Safety



Warning

Electric voltage!

Dangerous currents flow through the body when coming into direct or indirect contact with live components.

This can result in electric shock, burns or even death.

- Disconnect the mains power supply prior to installation and/or disassembly!
- Permit work on the 100-240 V supply system to be performed only by specialist staff!

3 Intended use

As a part of the Busch-Welcome® IP system, this device can only be used with accessories from the system.

4 Environment



Consider the protection of the environment!

Used electric and electronic devices must not be disposed of with household waste.

- The device contains valuable raw materials that can be recycled. Therefore, dispose of the device at the appropriate collecting facility.

4.1 Busch-Jaeger devices

All packaging materials and devices from Busch-Jaeger bear the markings and test seals for proper disposal. Always dispose of the packing materials and electric devices and their components via an authorized collection facility or disposal company.

Busch-Jaeger products meet the legal requirements, in particular the laws governing electronic and electrical devices and the REACH ordinance.

(EU-Directive 2012/19/EU WEEE and 2011/65/EU RoHS)

(EU-REACH ordinance and law for the implementation of the ordinance (EG) No.1907/2006)

5 Product description

5.1 Device type

Article number	Product ID	Product name	Colour	Size (DxHxW) Unit: mm
H8308-03	2TMA130160W0042	IP Elevator controller	Grey	90 x 72 x 65

5.2 Terminal description

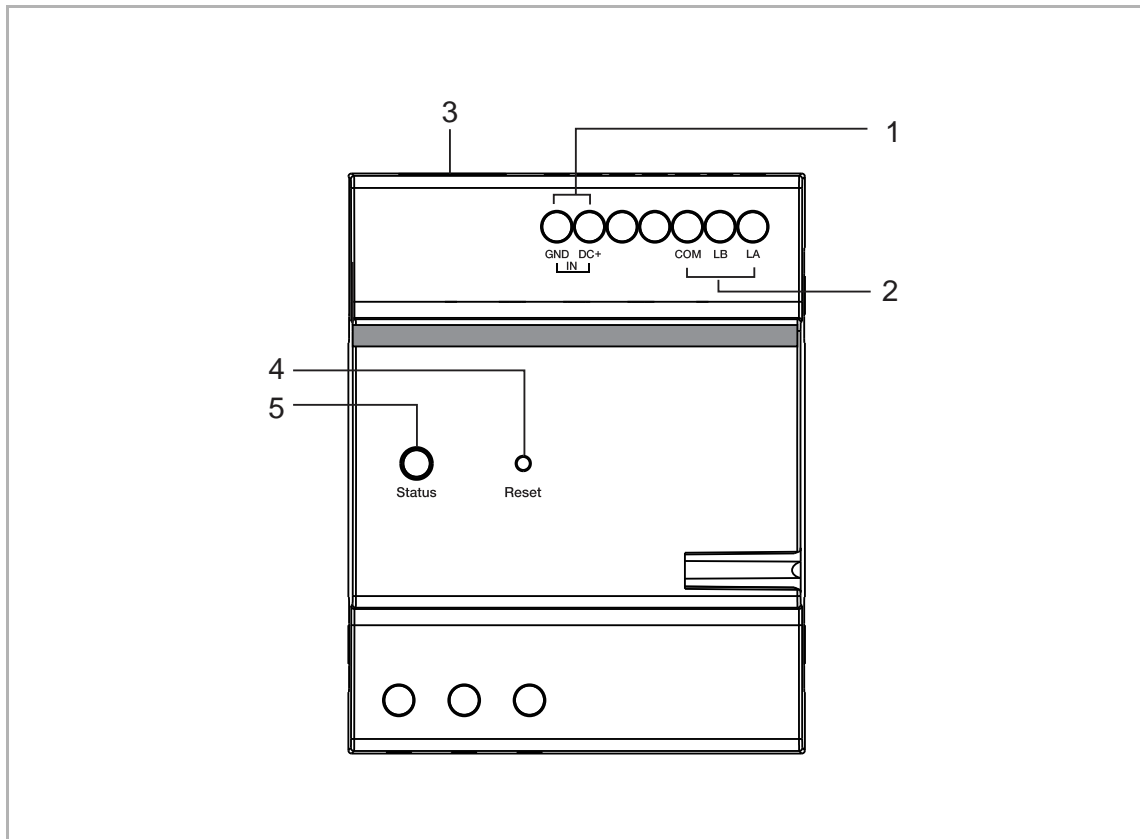

No.	Function
1	System power supply connector
2	RS485 connector
3	LAN (PoE)
4	<p>Reset button</p> <p>Press and hold this button for 10 seconds at any time to restore the device to the factory defaults. The status indicator will go off for 3 seconds then start to flash slowly.</p>
5	<p>Status indicator</p> <ul style="list-style-type: none"> ▪ On: the device is working normally ▪ Off: the device is not powered on ▪ Flashing quickly: the device is working abnormally (e.g. IP conflict, no MAC address) ▪ Flashing slowly: the device has not obtained the signature

6 Technical data

Designation	Value
Rating voltage	24 V $\overline{=}$
Operating voltage range	20-27 V $\overline{=}$
Rating current	24 V $\overline{=}$, 60 mA
Operating temperature	-20 °C...+55 °C
Storage temperature	-20 °C...+70 °C
PoE standard	IEEE802.3 af

7 Mounting/Installation



Warning

Electric voltage!

Dangerous currents flow through the body when coming into direct or indirect contact with live components.

This can result in electric shock, burns or even death.

- Disconnect the mains power supply prior to installation and/or disassembly!
- Permit work on the 100-240 V supply system to be performed only by specialist staff!

7.1 Requirement for the electrician



Warning

Electric voltage!

Install the device only if you have the necessary electrical engineering knowledge and experience.

- Incorrect installation endangers your life and that of the user of the electrical system.
- Incorrect installation can cause serious damage to property, e.g. due to fire.

The minimum necessary expert knowledge and requirements for the installation are as follows:

- Apply the "five safety rules" (DIN VDE 0105, EN 50110):
 1. Disconnect
 2. Secure against being re-connected
 3. Ensure there is no voltage
 4. Connect to earth and short-circuit
 5. Cover or barricade adjacent live parts.
- Use suitable personal protective clothing.
- Use only suitable tools and measuring devices.
- Check the type of supply network (TN system, IT system, TT system) to secure the following power supply conditions (classic connection to ground, protective grounding, necessary additional measures, etc.).

7.2 Mounting

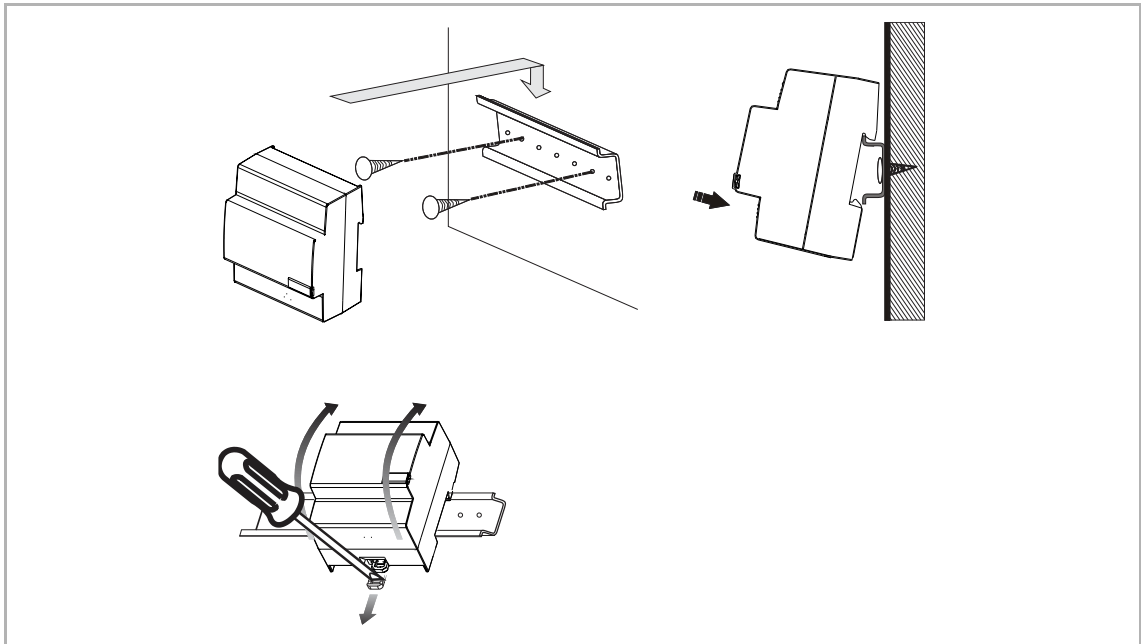

8 Commissioning

8.1 Topology

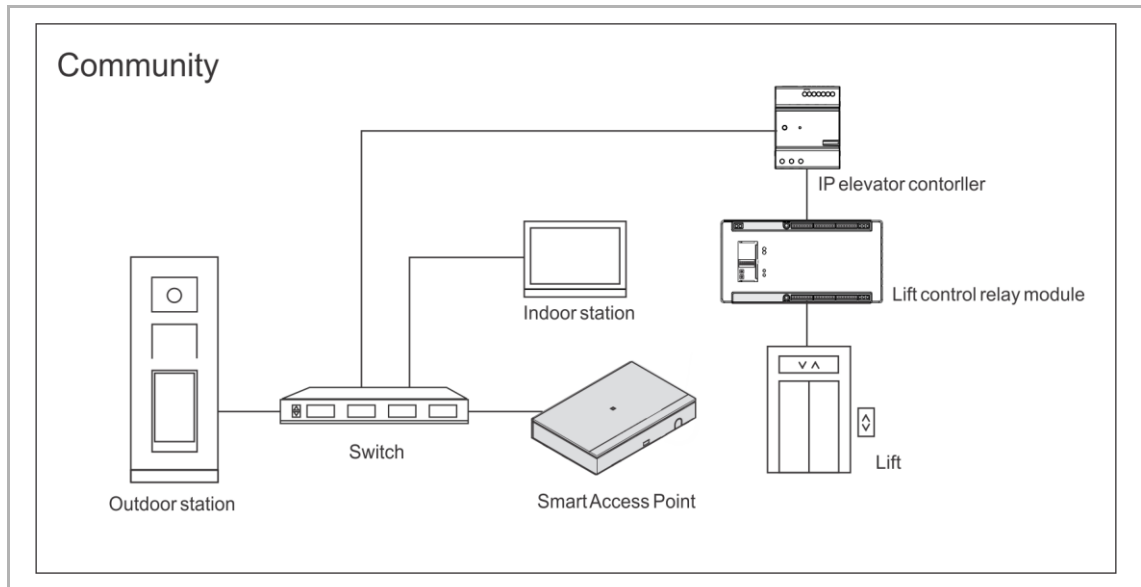

Outdoor station

Outdoor station type	Support "Elevator control" or not?
IP touch 5 outdoor station	Yes, but its firmware version should be V1.32 or higher
IP keypad outdoor station	Yes, but its firmware version should be V1.32 or higher
IP pushbutton outdoor station	Yes, but its firmware version should be V1.32 or higher
Mini outdoor station	No

Indoor station

Indoor station type	Support "Elevator control" or not?
IP touch 7	Yes, but its firmware version should be V2.34 or higher
IP touch 10	Yes, but its firmware version should be V2.27 or higher
Audio IP	No

Smart Access Control

Smart Access Control type	Support "Elevator control" or not?
Smart Access Control Pro	Yes, but its firmware version should be V6.23 or higher

Capacity

One block supports a maximum of 4 IP elevator controllers.

One IP elevator controller supports a maximum of 16 relay modules.

One relay module supports a maximum of 16 channels.

8.2 Adding devices

Precondition

- All the devices to be added manually must be powered on.
- None of the devices to be added manually should be signed by another "Smart Access Point". If the devices have been signed by another "Smart Access Point", you need to clear the signature e.g. resetting the device to the factory defaults.

Adding the devices manually

Please follow the steps below:

[1] On the configuration screen, click "Door entry system" to access the corresponding screen.

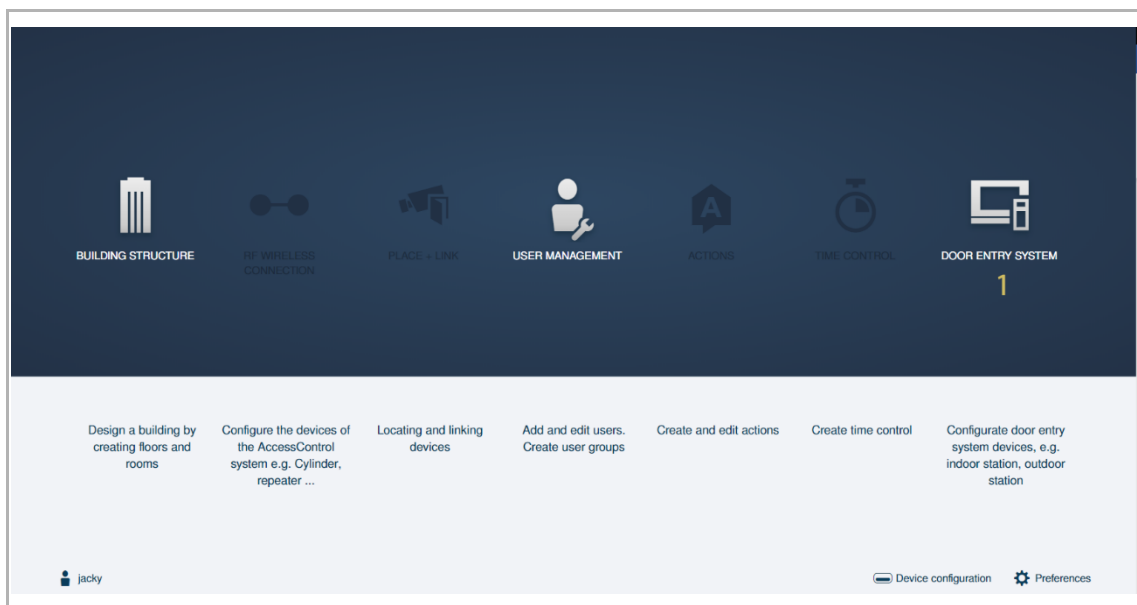

- [2] On the "Door Entry System" screen, click "Add device".
- [3] Select "Elevator Controller" from the drop-down list.
- [4] Enter the block number.
- [5] Enter the device number.
- [6] Enter the serial number.
- [7] Click "Save".

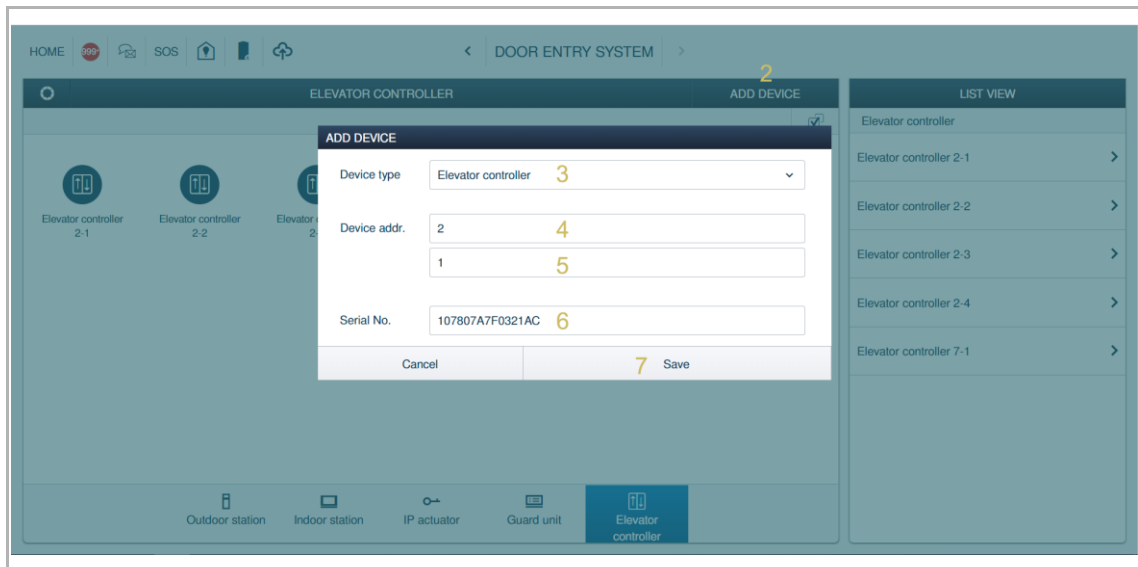

Note

If the device has already been signed by another "Smart Access Point", it will not be signed.

8.3 Accessing the setting screen

Please follow the steps below:

- [1] On the "Door Entry System" screen, click "Elevator Controller".
- [2] Click the designated elevator controller to access the corresponding screen.
- [3] Click "Settings" to access the settings screen.
- [4] If you have already saved a configuration, click "Saved Configuration" to edit the existing settings directly.

The screenshot displays the 'DOOR ENTRY SYSTEM' interface. The top section shows the 'ELEVATOR CONTROLLER' screen with five controller icons labeled 2-1, 2-2, 2-3, 2-4, and 7-1. A yellow '2' is placed above the 2-1 icon. The bottom navigation bar includes 'Outdoor station', 'Indoor station', 'IP actuator', 'Guard unit', and 'Elevator controller' (highlighted with a yellow '1').

The second screenshot shows the 'Elevator controller 2-1' settings screen. It features a photo of the physical device, an 'H3308 IP Elevator controller / IP电梯联动模块' with technical specifications. The bottom navigation bar has 'Settings' (highlighted with a yellow '3') and 'Saved Configuration' (highlighted with a yellow '4'). The right sidebar contains a 'LIST VIEW' with fields for 'Block No.: 2', 'Device No.: 1', 'Serial No.: 107807A7F0321AC', 'Version: HGM51-EC_MAIN_V0.15_20221111_ES_SSD201', 'MCU version: HGM51-EC_MCU_V0.07_20221111_PS', 'Configure Mode: Preconfigured', and 'Relay status (NC/NO) for authorization'.

8.4 Basic information

On the "Settings" screen:

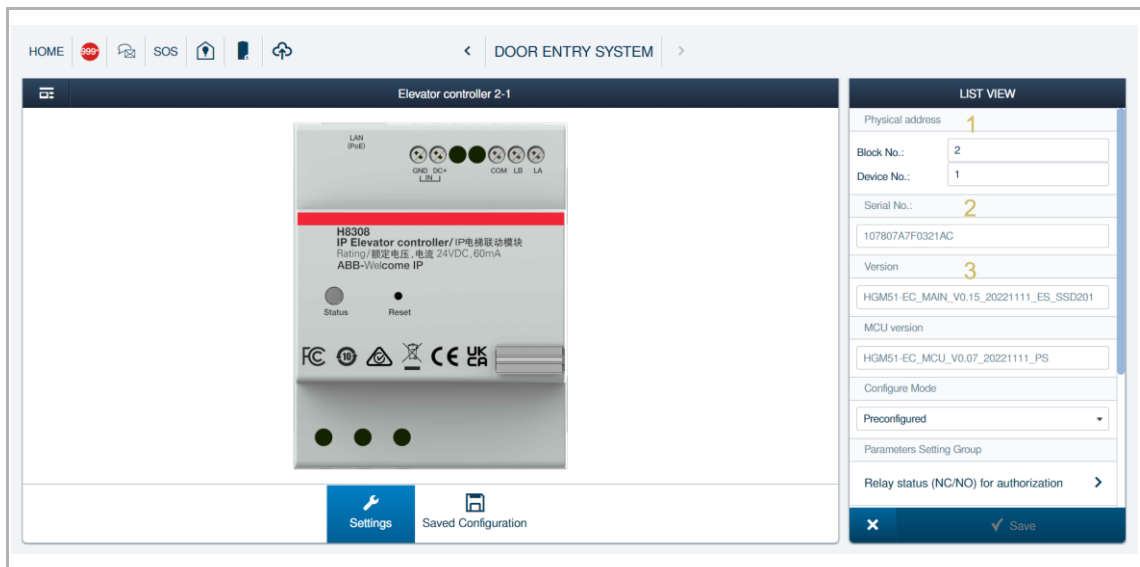

No.	Description
1	Display the physical address of the device (block no. & device no.).
2	Display the serial no. of the device.
3	Display the firmware version and MCU version of the device.

8.5 Configure mode

There are 3 optional configuration modes.

	Pre-configuration mode	Semi-automatic configuration mode	Manual mode
Lowest floor level below ground	-3	-3	-7
Highest floor level above ground	18	32	63
Maximum number of elevators supported	1	according to actual requirement	according to actual requirement
Maximum number of outdoor stations supported	64	64	64
Call elevator according to the room number	No	No	Yes

8.5.1 Pre-configuration mode

This mode is usually used for a simple project, e.g. a building which has not more than 18 floors above the ground floor.

This mode can guide you through completion of all configuration work step by step.

User case 1

Question	Answer
Which floors need to support the elevator control?	-1, 1, 2, 3, 4, 5, 6
Where are the outdoor stations installed?	Outdoor station 1 is installed on floor 1 Outdoor station 2 is installed on floor -1
Is the "call elevator from indoor station" function needed?	Yes

The following steps below are based on the user case 1, please adjust the settings according to the actual case:

[1] On the "Settings" screen, select "Preconfigured" from the drop-down list.

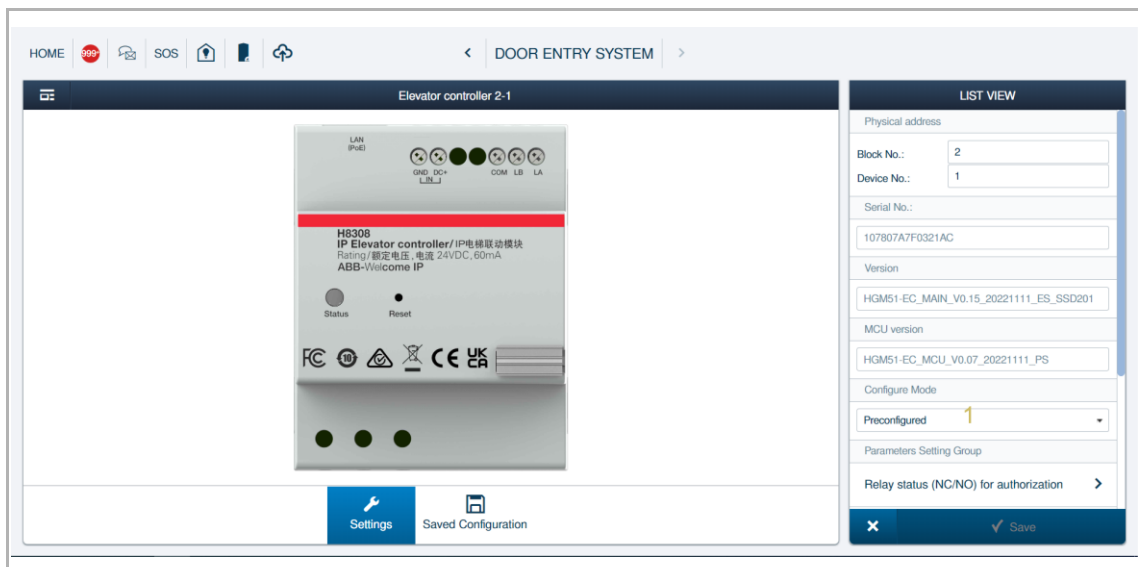

[2] On the "Floors Selection" screen:

- Select the designated floors needed to support the "elevator control" function.
 - When a floor is pressed, the selection will be visual.
 - Click "Select all" to select all floors
 - Click "Inverse" to invert the selection of existing floors.



Note

Please note that the first floor above the ground will be indicated with the number 1, and the one right below, with the number -1.

- Click "Next".

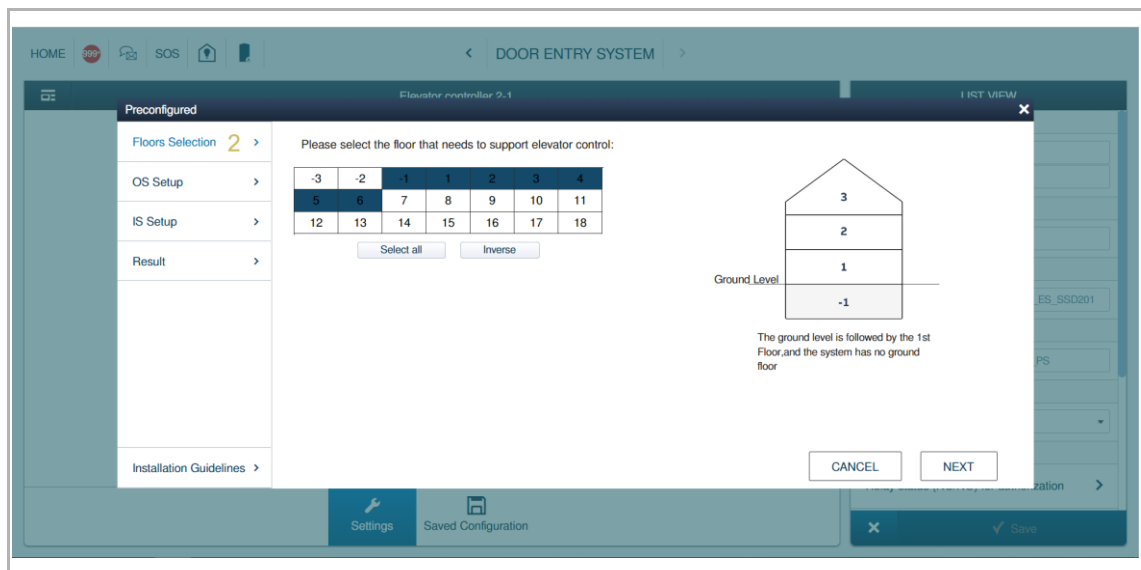

[3] On the "OS Setup" screen:

- Select the floor for each outdoor station to be installed
 - Click "Add an outdoor station", then set the device no. and the floor no. for the outdoor station installed.
 - Click "🗑️" to remove the existing outdoor station.
- Click "Next".

[4] On the "IS Setup" screen:

- Select "Enable" to allow the Indoor Station to call the elevator from the apartment. This will allow the resident to request the elevator even when no external calls have been triggered.
- Click "Next".

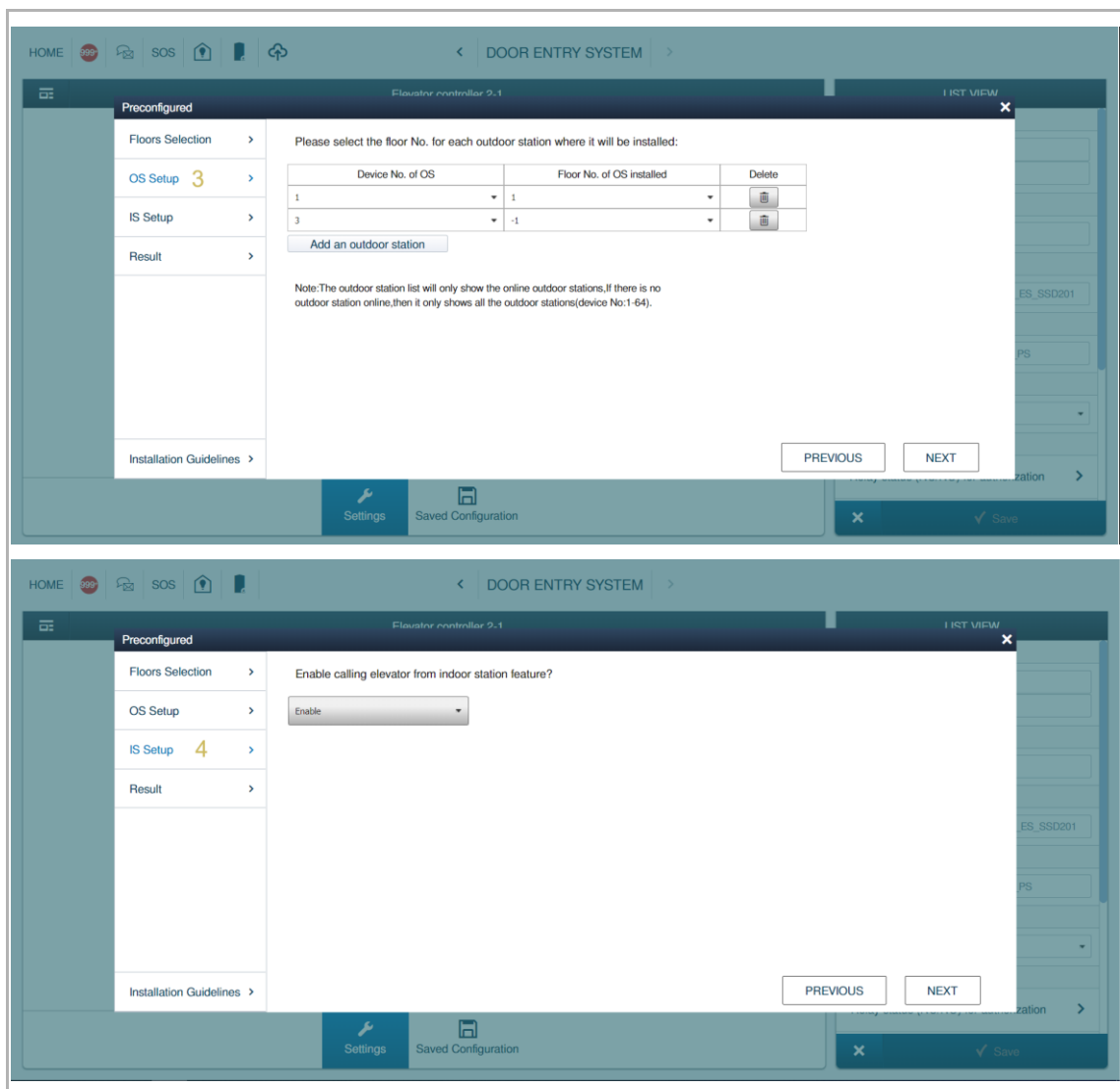

- [5] On the "Result" screen:
 - The recommended relay configurations will be displayed automatically.
- [6] Click "Save". The data can be viewed on the "Save Configuration" screen.
- [7] Click "Print" to print out the relay configurations for installation reference.
- [8] On the "Installation Guidelines" screen, more details on the installation can be viewed.

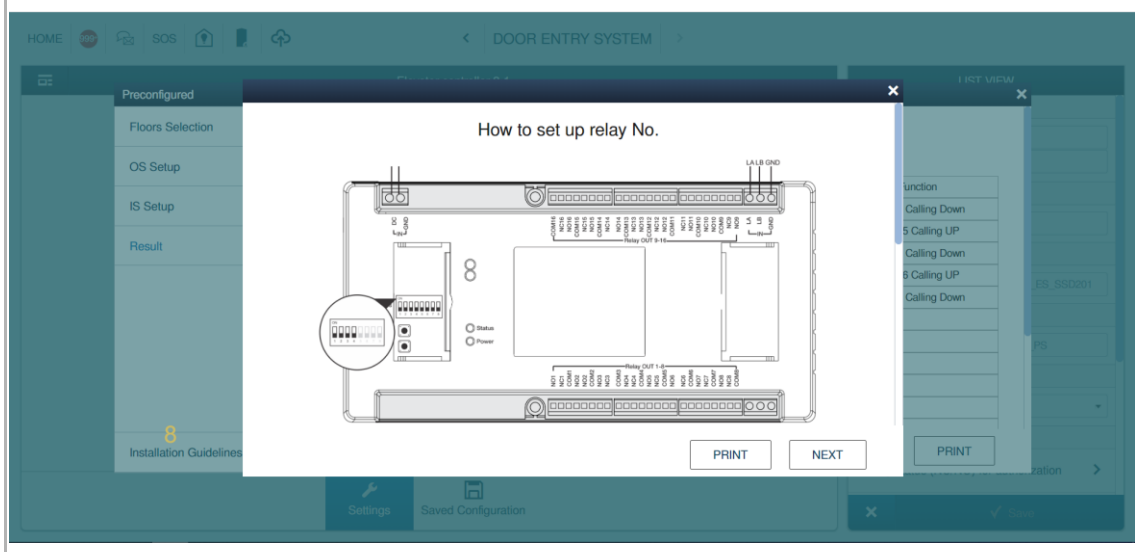
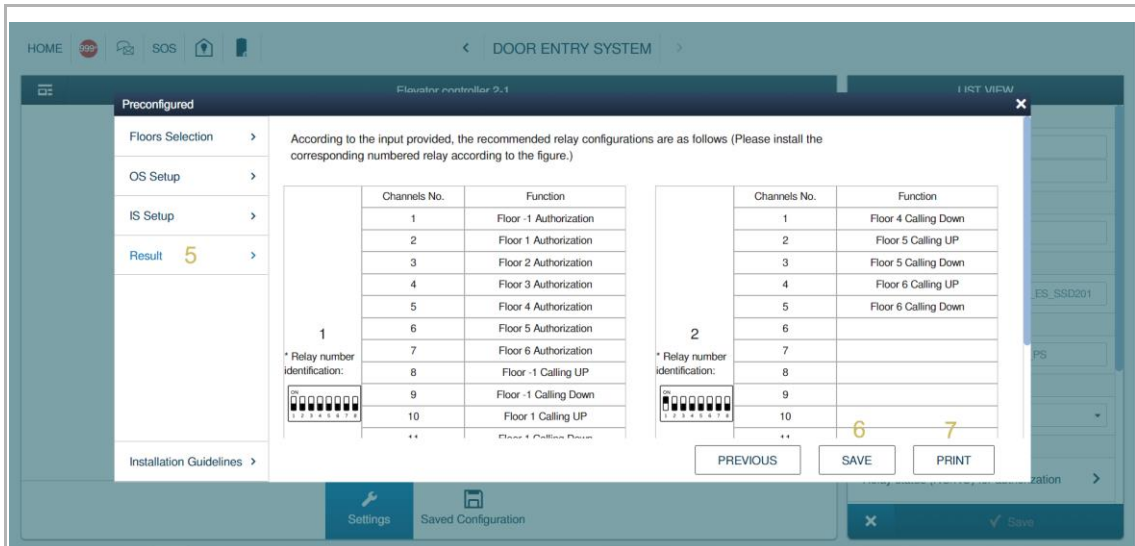

8.5.2 Semi-automatic configuration mode

This mode can be used for a medium-sized project, e.g. a building which has not more than 32 floors above the ground floor. Please see the "Configure mode overview" chapter for more details.

This mode can give you some freedom when configuring the settings.

User case 2

Question	Answer
Which floors need to support the elevator control?	-1, 1, 2, 3, 4, 5, 6
Where are the outdoor stations installed?	Outdoor station 1 is installed on floor 1 Outdoor station 2 is installed on floor -1
Is the "call elevator from indoor station" function needed?	Yes

The following steps below are based on the user case 2, please adjust the settings according to the actual situation:

[1] On the "Settings" screen, select "Semi-automatic Configuration" from the drop-down list.

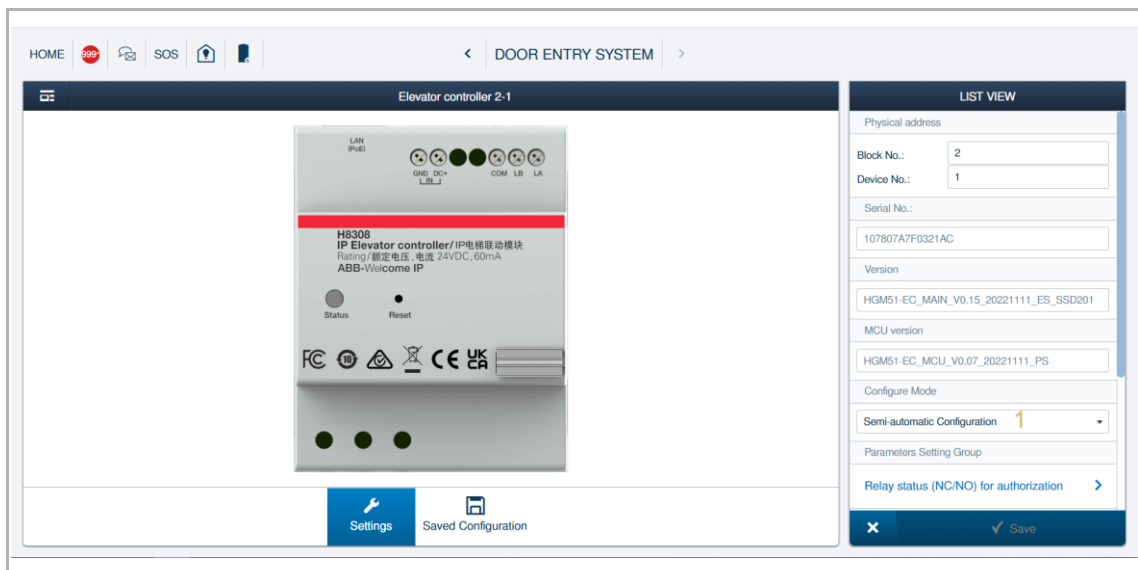

[2] On the "Floors Selection" screen:

- Select the designated floors which need to support the "elevator control" function.
 - When a floor is pressed, the selection will be displayed visually.
 - Click "Select all" to select all floors.
 - Click "Inverse" to invert the selection of the existing floors.



Note

Please note that the first floor above the ground will be indicated with the number 1, and the one right below, with the number -1.

- Click "Next".

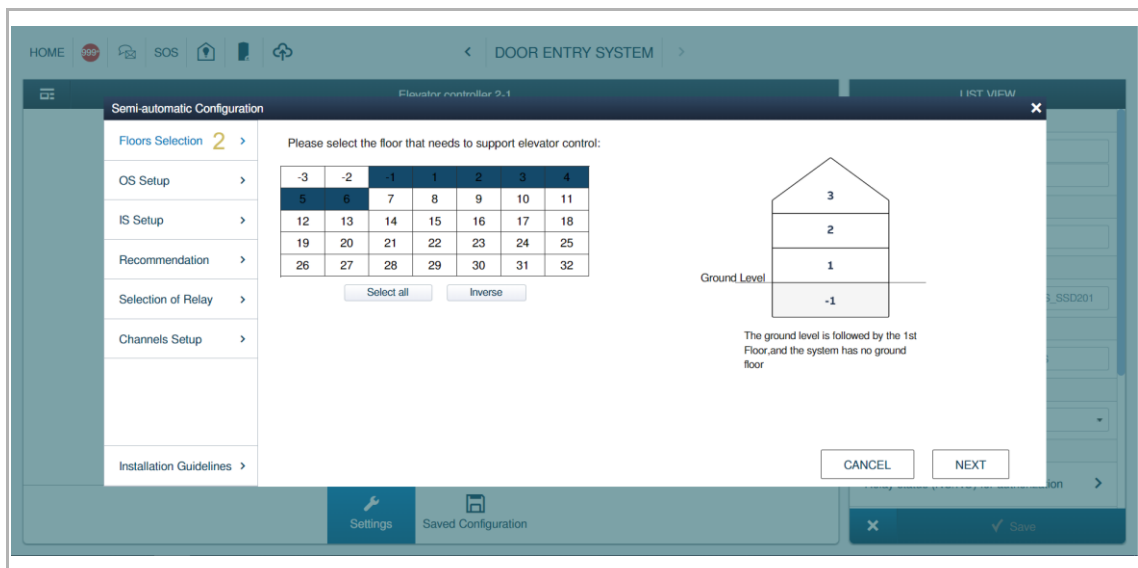

[3] On the "OS Setup" screen:

- Select the floor for each outdoor station to be installed
 - Click "Add an outdoor station", then set the device no. and the floor no. for the outdoor station installed.
 - Click "🗑️" to remove the existing outdoor station.
- Click "Next".

[4] On the "IS Setup" screen:

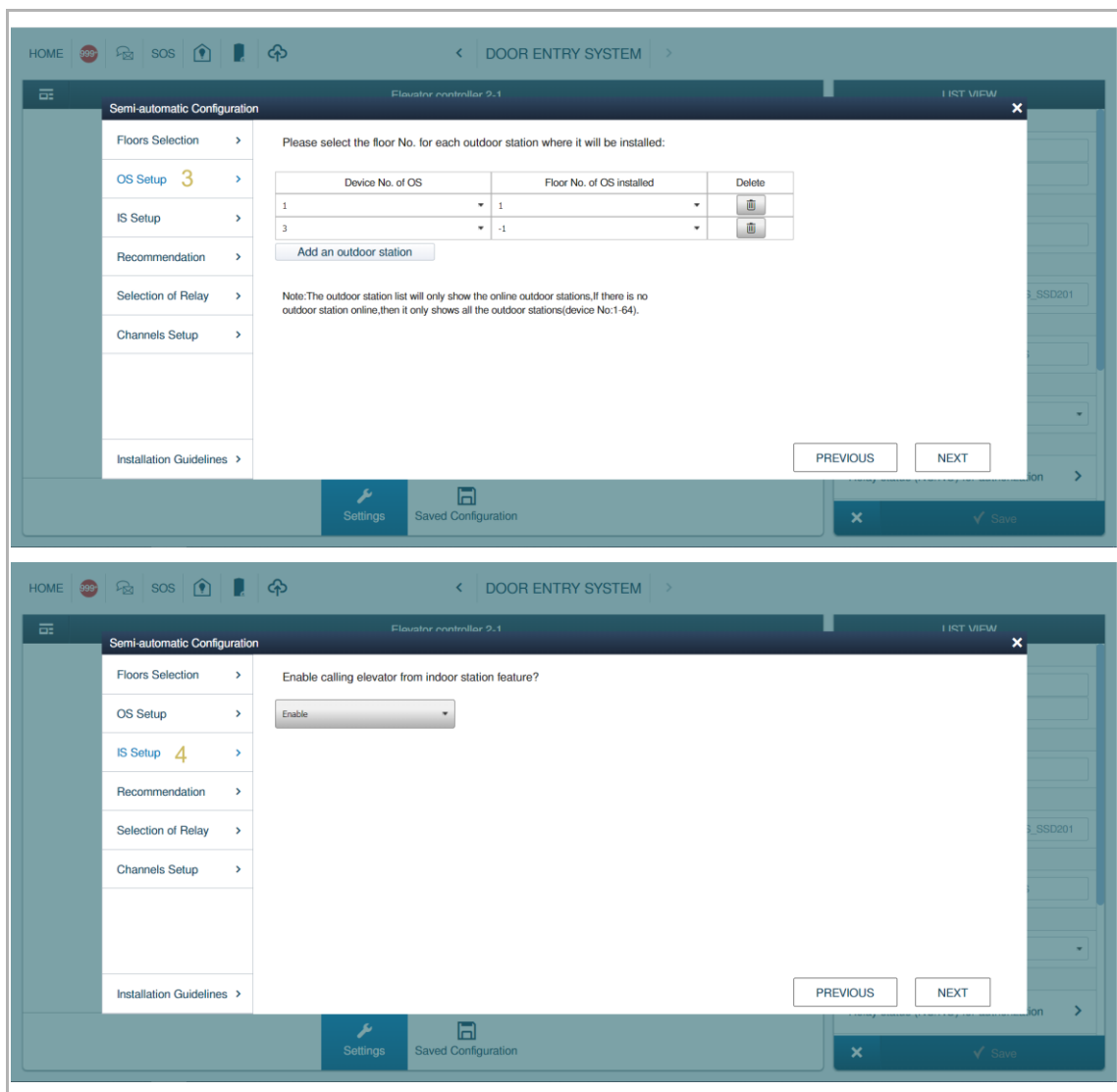

- Select "Enable" to allow the Indoor Station to call the elevator from the apartment. This will allow the resident to request the elevator even when no external calls have been triggered.
- Click "Next".



[5] On the "Recommendation" screen:

- The number of relay modules recommended will be displayed.
- Click "Next".

[6] On the "Selection of Relay" screen:

- Select the designated relay modules by ticking the checkbox.
 -  indicates the selected relay modules have been configured before.
 -  indicates the selected relay modules have not been configured before.
 -  indicates the relay modules that are detected online.
- Click "Next".

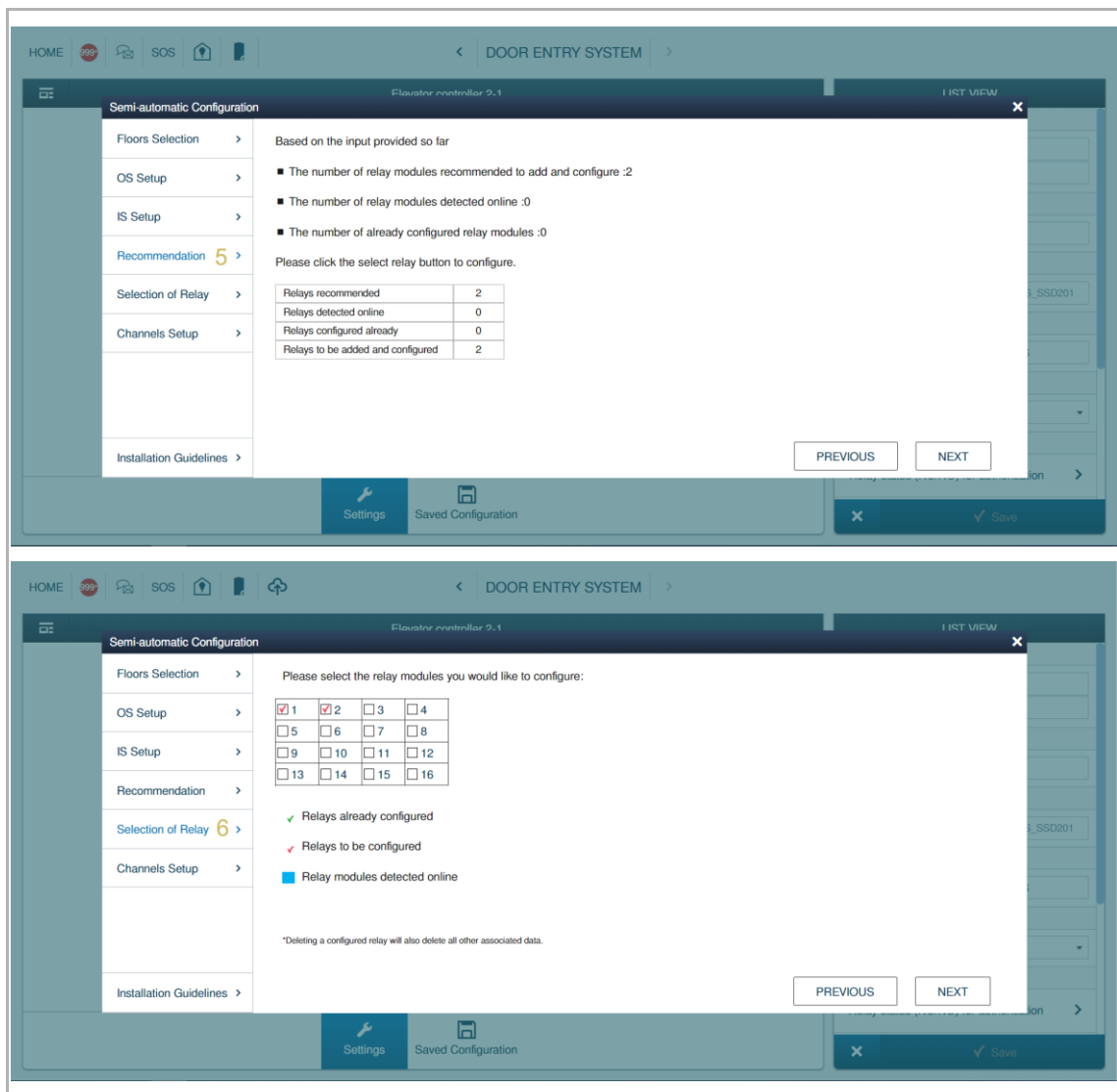

- [7] On the "Channel Setup" screen,
 - Select the floor no. and the function for each channel.
 - "Calling up"
 - "Calling down"
 - "Authorization"
 - Click "Clear" to clear all the inputs in the table for the current relay module.
- [8] Click "Save". The data can be viewed on the "Saved Configuration" screen.
- [9] Click "Print" to print out the relay configurations for installation reference.
- [10] The "Installation Guidelines" screen shows more details about the installation.

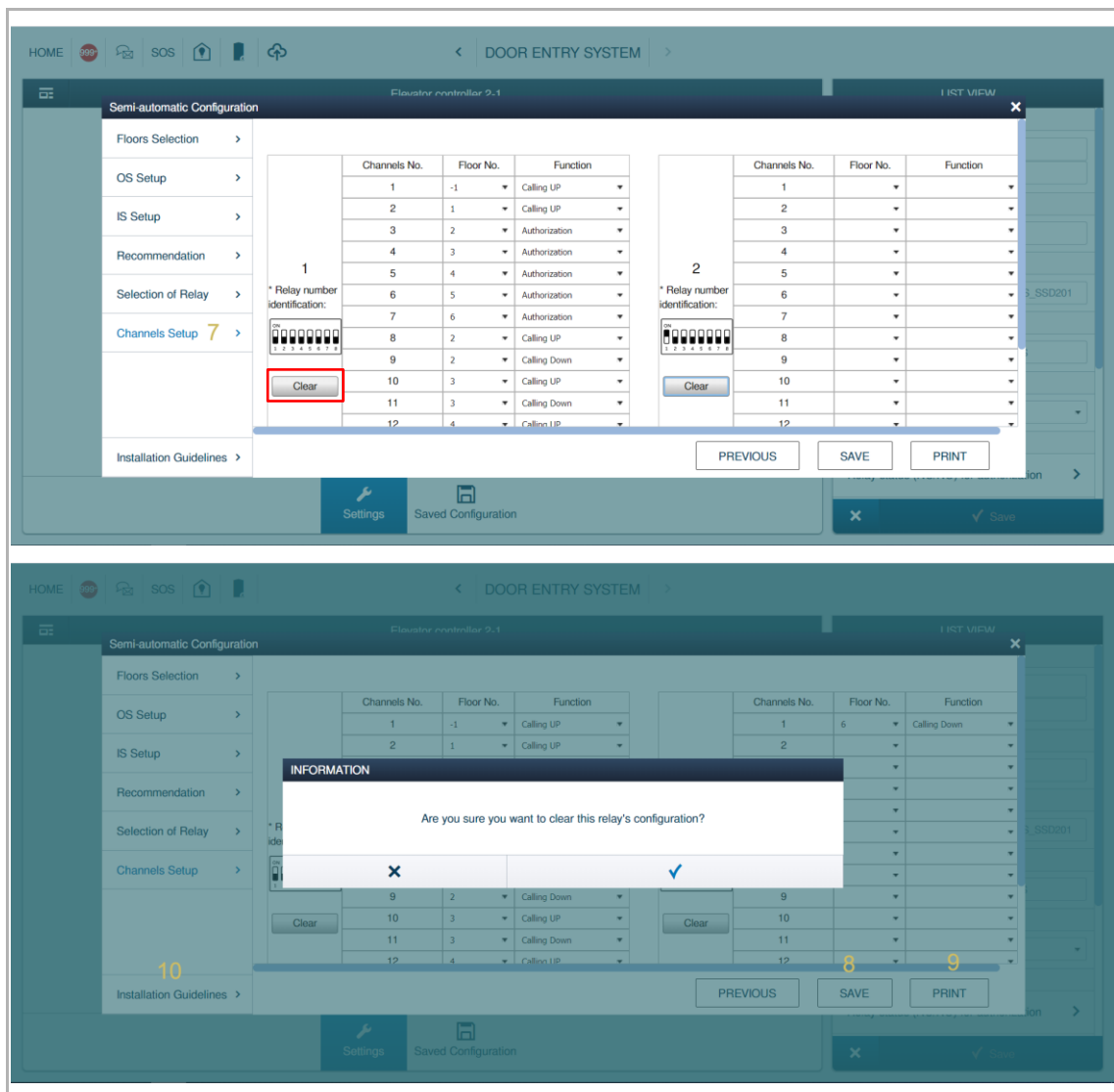

8.5.3 Manual mode

This mode can be used for a large project, e.g. a building which has no more than 63 floors above the ground floor. Please see "Configure mode overview" chapter for more details.

This mode gives you complete freedom when configuring the settings.

There are 3 events that need to be set in manual mode:

1. Unlock event
 - In this event, the elevator will be called to the floor where the outdoor station is installed, and the designated floor will be authorized for a period of time.
 - This event contains 4 scenarios:
 - The resident releases the lock via the indoor station or App in standby status.
 - The resident releases the lock via the indoor station during an incoming call.
 - The resident releases the lock via the indoor station during surveillance.
 - The resident releases the lock via the outdoor station when swiping the card or entering the unlock password.
2. Calling the elevator from indoor station
 - In this event, the elevator will be called to the floor where the resident lives.
3. Authorization Flat to Flat
 - During an intercom call between two flats in the same building, when someone presses the call authorization button at any time, the corresponding floor will be authorized within a specified time.

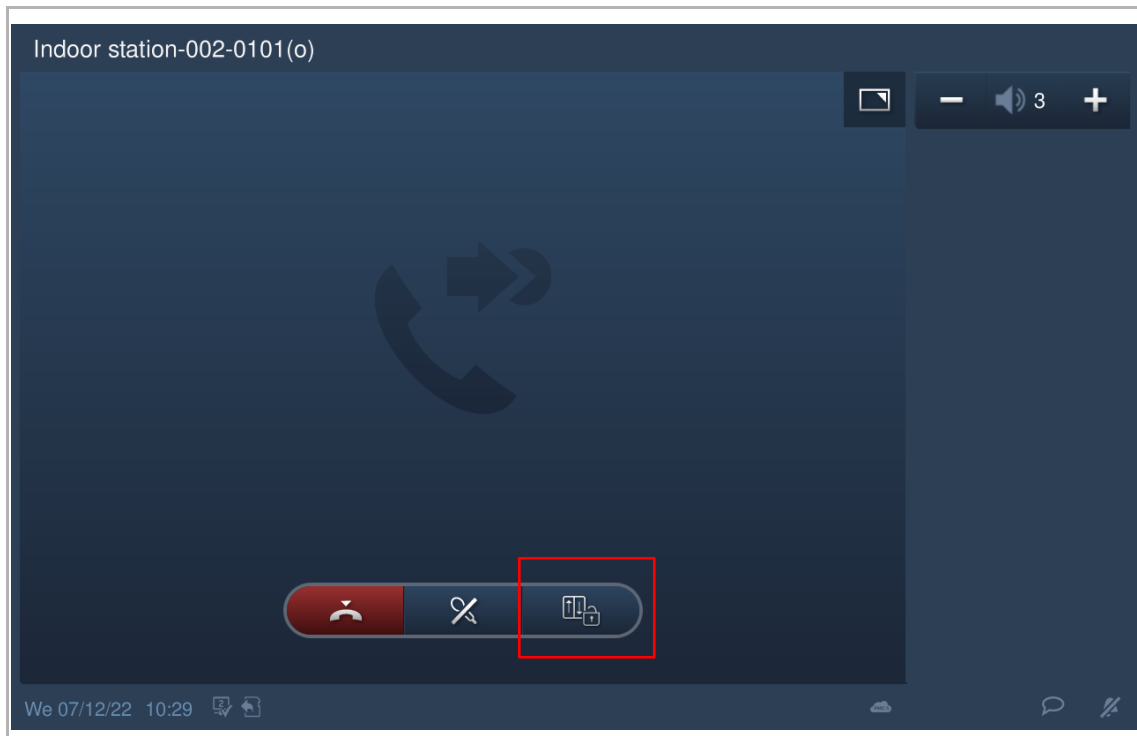

User case 3

Question	Answer
Which floors need to support the elevator control?	-1, 1, 2, 3, 4, 5, 6
Where are the outdoor stations installed?	Outdoor station 1 is installed on floor 1 Outdoor station 2 is installed on floor -1
Is the "call elevator from indoor station" function needed?	Yes

The following steps below are based on the user case 3, please adjust the settings according to the actual case:

[1] On the "Settings" screen, select "Manual Configuration" from the drop-down list.

[2] On the "Unlock Event" screen, set the data as below:

- Click "Add a row" to add a record.
- Click "Delete selected row" to delete the selected row.
- Click "Next" to continue the setting.

The screenshot shows the 'Manual Configuration' screen for the elevator controller. The table below represents the data entered in the 'Unlock Event' section:

OS No.	User Floor No.	User Room No.	Relay No. For Calling Elevator	Channel No. For Calling Elevator
1	2	*	1	1
1	3	*	1	1
1	4	*	1	1
1	5	*	1	1
1	6	*	1	1
2	2	*	1	2
2	3	*	1	2
2	4	*	1	2
2	5	*	1	2
2	6	*	1	2

Buttons at the bottom of the table include: '+ Add a row', '- Delete selected row', 'NEXT', 'PRINT', 'EXPORT', and 'IMPORT'.

- [3] On the "Calling From IS" screen, set the data as below:
 - Click "Add a row" to add a record.
 - Click "Delete selected row" to delete the selected row.
 - Click "Next" to continue the setting.
- [4] On the "Authorization Flat to Flat" screen, set the data as below:
 - Click "Add a row" to add a record.
 - Click "Delete selected row" to delete the selected row.
- [5] Click "Save". The data can be viewed on the "Save Configuration" screen.
- [6] Click "Print" to print out the relay configuration tables for installation reference.
- [7] Click "Export" to export a CSV file.
- [8] Click "Import" to import a CSV file.
- [9] The "Operate Guidelines" screen shows more details about the operation.
- [10] The "Installation Guidelines" screen shows more details about the installation.

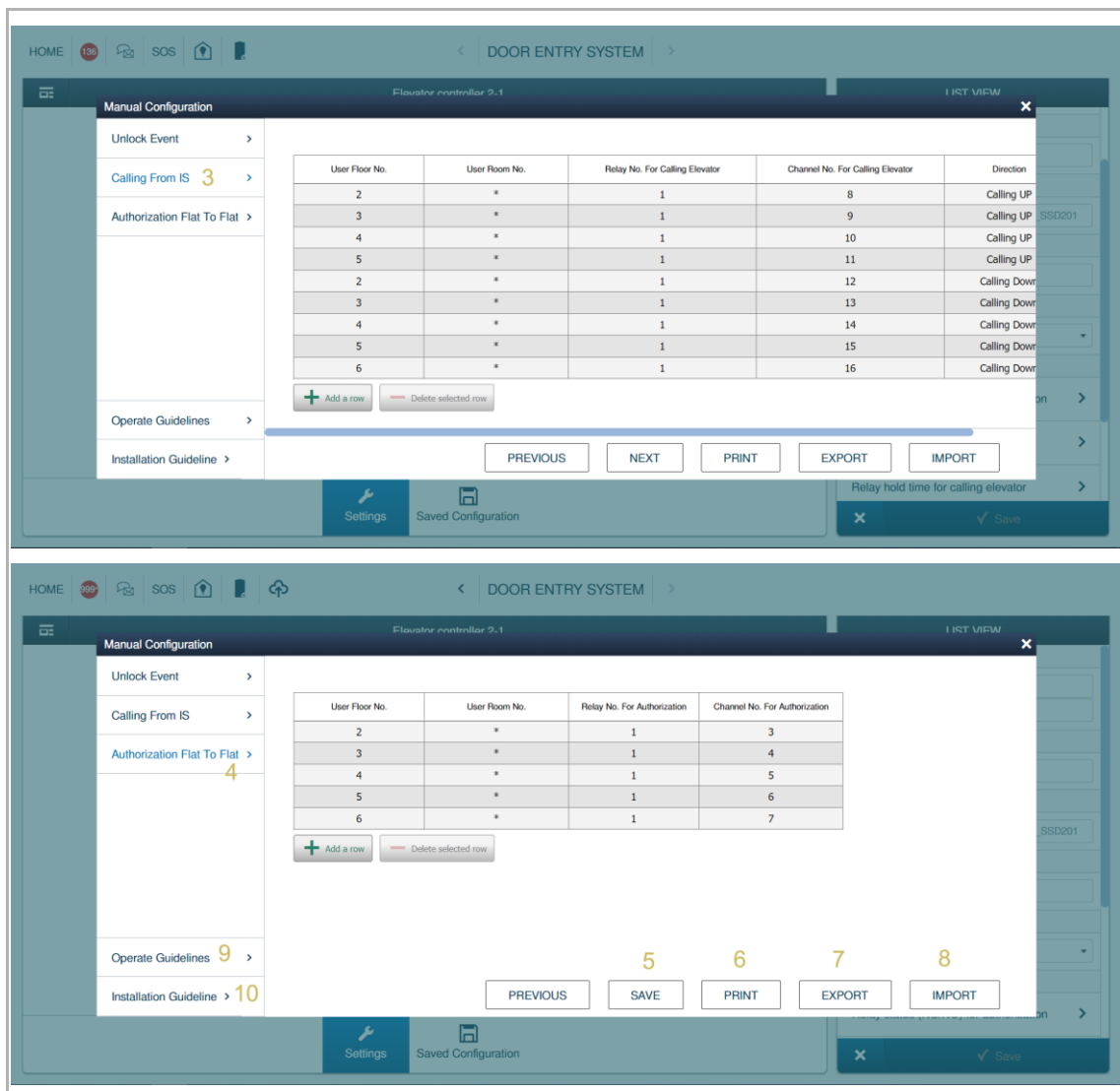

Exporting CSV file

- [1] Don't change the event title (marked in red).
- [2] Don't change the column title or the column order (marked in blue).

	A	B	C	D	E	F	G	H
1	*****	Unlock event						
2	OS No.	User Floor	User Room	Relay No.	Channel No.	Relay No.	Channel No.	For Author
3	1	2 *		1	1	1	3	
4	1	3 *		1	1	1	4	
5	1	4 *		1	1	1	5	
6	1	5 *		1	1	1	6	
7	1	6 *		1	1	1	7	
8	2	2 *		1	2	1	3	
9	2	3 *		1	2	1	4	
10	2	4 *		1	2	1	5	
11	2	5 *		1	2	1	6	
12	2	6 *		1	2	1	7	
13	*****	Call elevator from indoor station						
14	User Floor	User Room	Relay No.	Channel No.	Direction(1:UP/ 2:DOWN)			
15	2 *		1	8	1			
16	3 *		1	9	1			
17	4 *		1	10	1			
18	5 *		1	11	1			
19	2 *		1	12	2			
20	3 *		1	13	2			
21	4 *		1	14	2			
22	5 *		1	15	2			
23	6 *		1	16	2			
24	*****	Authorization for Apartment call						
25	User Floor	User Room	Relay No.	Channel No.	For Authorization			
26	2 *		1	3				
27	3 *		1	4				
28	4 *		1	5				
29	5 *		1	6				
30	6 *		1	7				
31								

8.5.4 Editing the existing configuration

Please follow the steps below:

- [1] On the designated IP elevator controller screen, click "Saved Configuration".
- [2] Click "Edit" to edit the existing configuration.

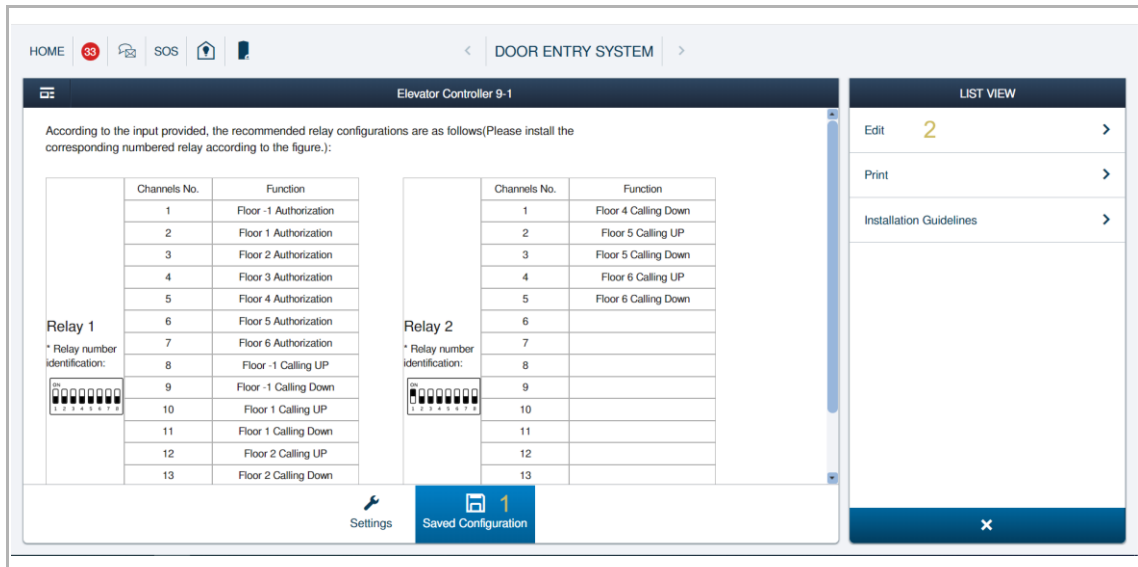

8.6 Parameter settings

8.6.1 Relay status for authorization

Please follow the steps below:

[1] On the "Settings" screen, click "Relay status (NC/NO) for authorization".

[2] Select the relay status:

- NC
- NO

[3] Click "Save".

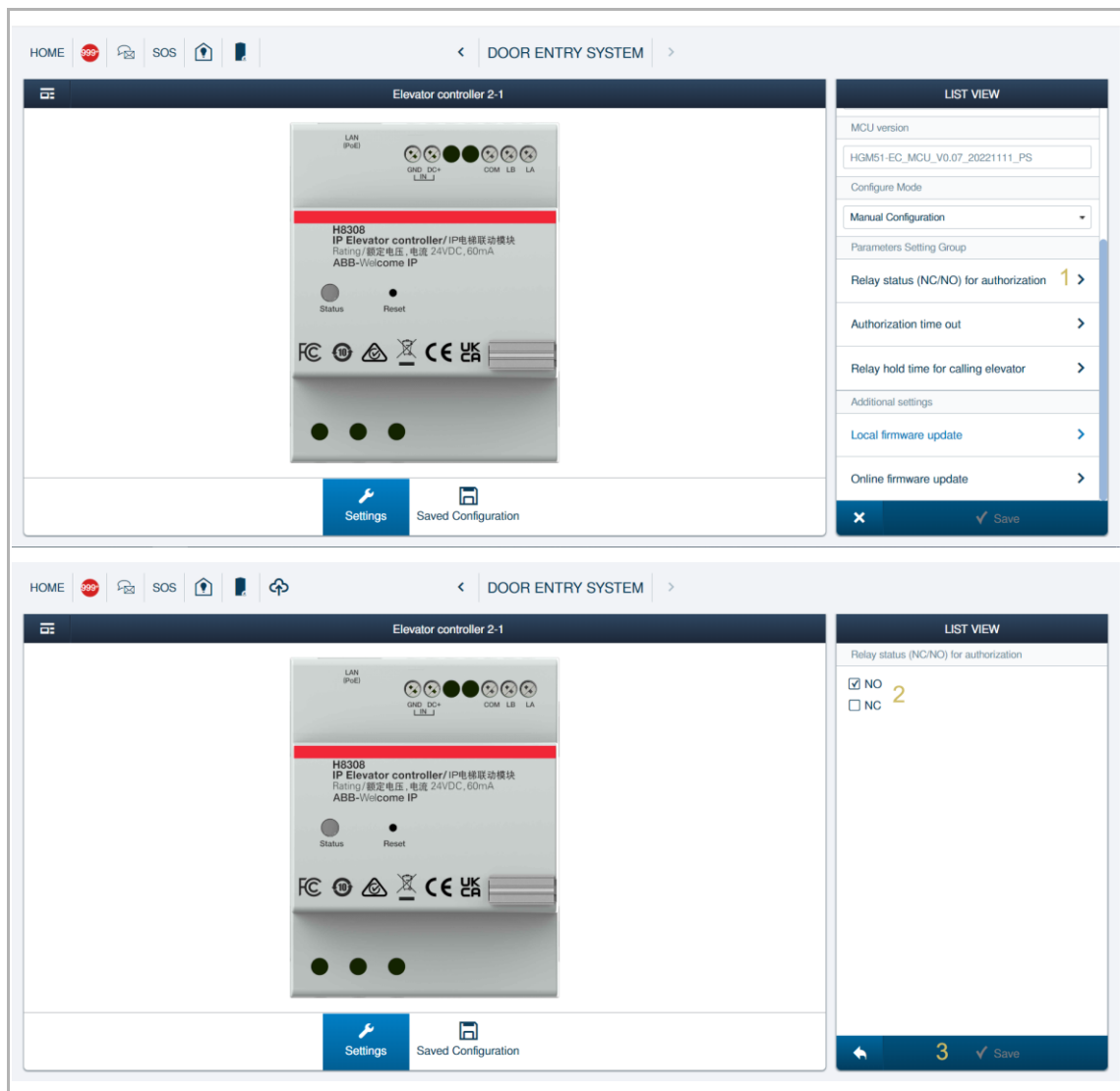

8.6.2 Authorization time out

Please follow the steps below:

[1] On the "Settings" screen, click "Authorization time out".

[2] Select an authorization time:

- 2 minutes
- 4 minutes
- 6 minutes
- 8 minutes (default)
- 10 minutes
- 12 minutes

[3] Click "Save".

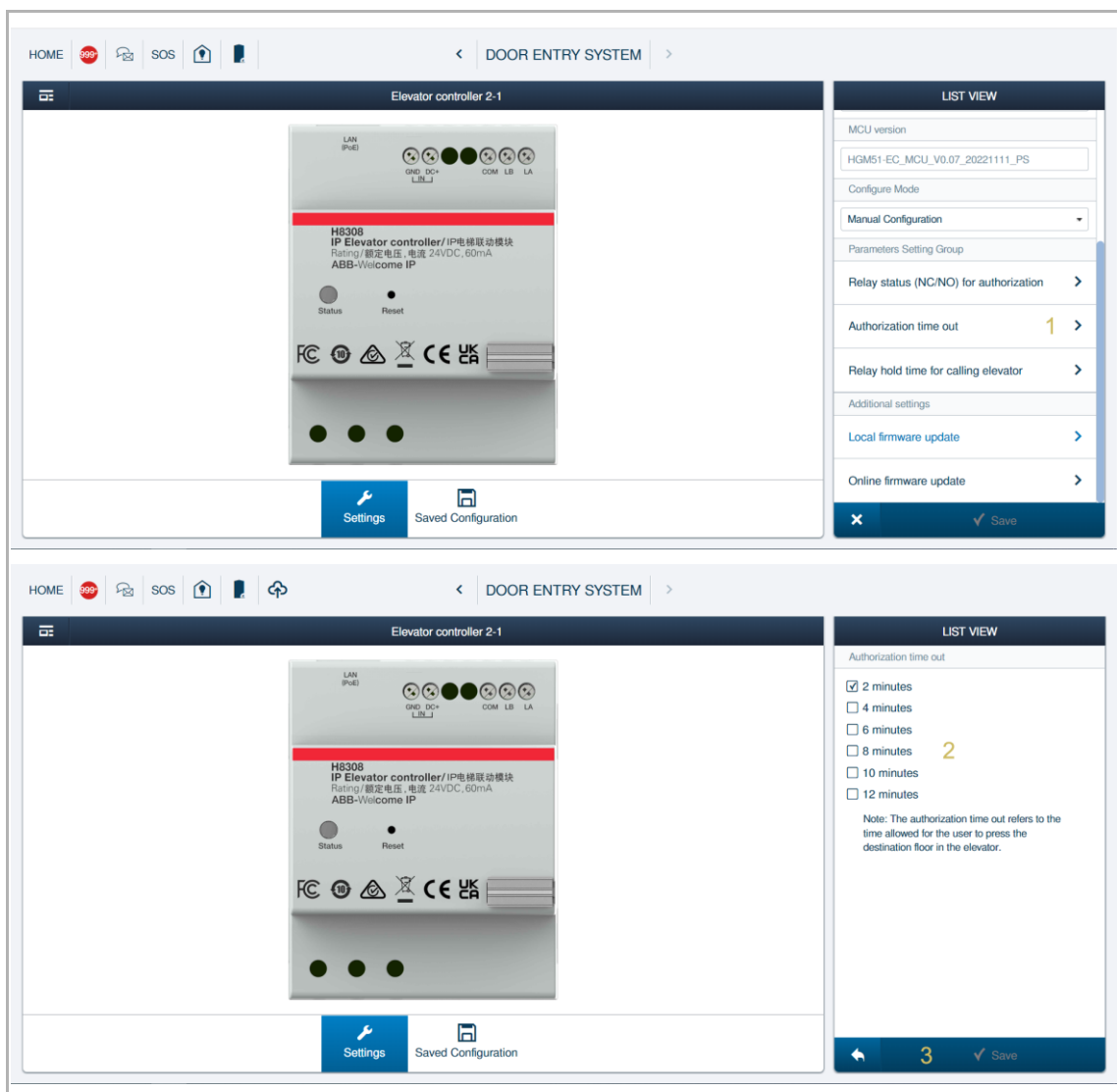

8.6.3 Relay hold time for calling elevator

Please follow the steps below:

[1] On the "Settings" screen, click "Relay hold time for calling elevator".

[2] Select the hold time for calling the elevator:

- 1 second
- 2 seconds
- 3 seconds (default)
- 4 seconds
- 5 seconds
- 6 seconds

[3] Click "Save".

The image displays two screenshots of the 'Elevator controller 2-1' settings interface. The top screenshot shows the 'Relay hold time for calling elevator' setting set to 1 second. The bottom screenshot shows the same setting set to 6 seconds.

Top Screenshot:

- Header: HOME, SOS, DOOR ENTRY SYSTEM
- Section: Elevator controller 2-1
- Device Image: H8308 IP Elevator controller / IP电梯联动模块. Rating: 额定电压, 电流 24VDC, 60mA. ABB-Vivacome IP.
- Buttons: Settings, Saved Configuration
- Right Panel (LIST VIEW):
 - MCU version: HGM51-EC_MCU_V0.07_20221111_PS
 - Configure Mode: Manual Configuration
 - Parameters Setting Group:
 - Relay status (NC/NO) for authorization >
 - Authorization time out >
 - Relay hold time for calling elevator 1 >
 - Additional settings:
 - Local firmware update >
 - Online firmware update >
 - Bottom Bar: Save

Bottom Screenshot:

- Header: HOME, SOS, DOOR ENTRY SYSTEM
- Section: Elevator controller 2-1
- Device Image: H8308 IP Elevator controller / IP电梯联动模块. Rating: 额定电压, 电流 24VDC, 60mA. ABB-Vivacome IP.
- Buttons: Settings, Saved Configuration
- Right Panel (LIST VIEW):
 - Relay hold time for calling elevator:
 - 1 second
 - 2 seconds
 - 3 seconds
 - 4 seconds 2
 - 5 seconds
 - 6 seconds
 - Note: The Relay hold time for calling elevator refers to how long the relay needs to remain energized to call the elevator
 - Bottom Bar: 3, Save

8.7 Updating the firmware

8.7.1 Updating the firmware via local PC

Please follow the steps below:

- [1] On the "Settings" screen, click "Local firmware update".
- [2] Click "Browse" to search the firmware update file.
- [3] Click "Browse" to search the firmware signature file.
- [4] Click "Firmware update".

The image displays two screenshots of the ABB elevator controller web interface, illustrating the steps for local firmware update.

Top Screenshot: Shows the "Elevator Controller 444-4" settings page. The main area displays a photo of the H8308 IP Elevator controller. On the right, the "LIST VIEW" panel shows device details: Block No. 444, Device No. 4, Serial No. 107807A7F0321A9, Version HGM51-EC_MAIN_V0.15_20221111_ES_SSD20, and MCU version HGM51-EC_MCU_V0.07_20221111_PS. The "Local firmware update" option is highlighted with a yellow '1' and a right-pointing arrow. A "Settings" button is visible at the bottom center.

Bottom Screenshot: Shows the same settings page after the "Local firmware update" option is selected. The "LIST VIEW" panel now shows "Local firmware update" with two "Browse" buttons. The first is for the "Firmware update file" (highlighted with a yellow '2') and the second is for the "Firmware signature file" (highlighted with a yellow '3'). At the bottom of the interface, a blue bar contains a left-pointing arrow, a yellow '4', and a checkmark icon followed by the text "Firmware update".

- [5] Click "I agree" to agree the "End user license agreement".
- [6] Click "Close" when the update is complete.

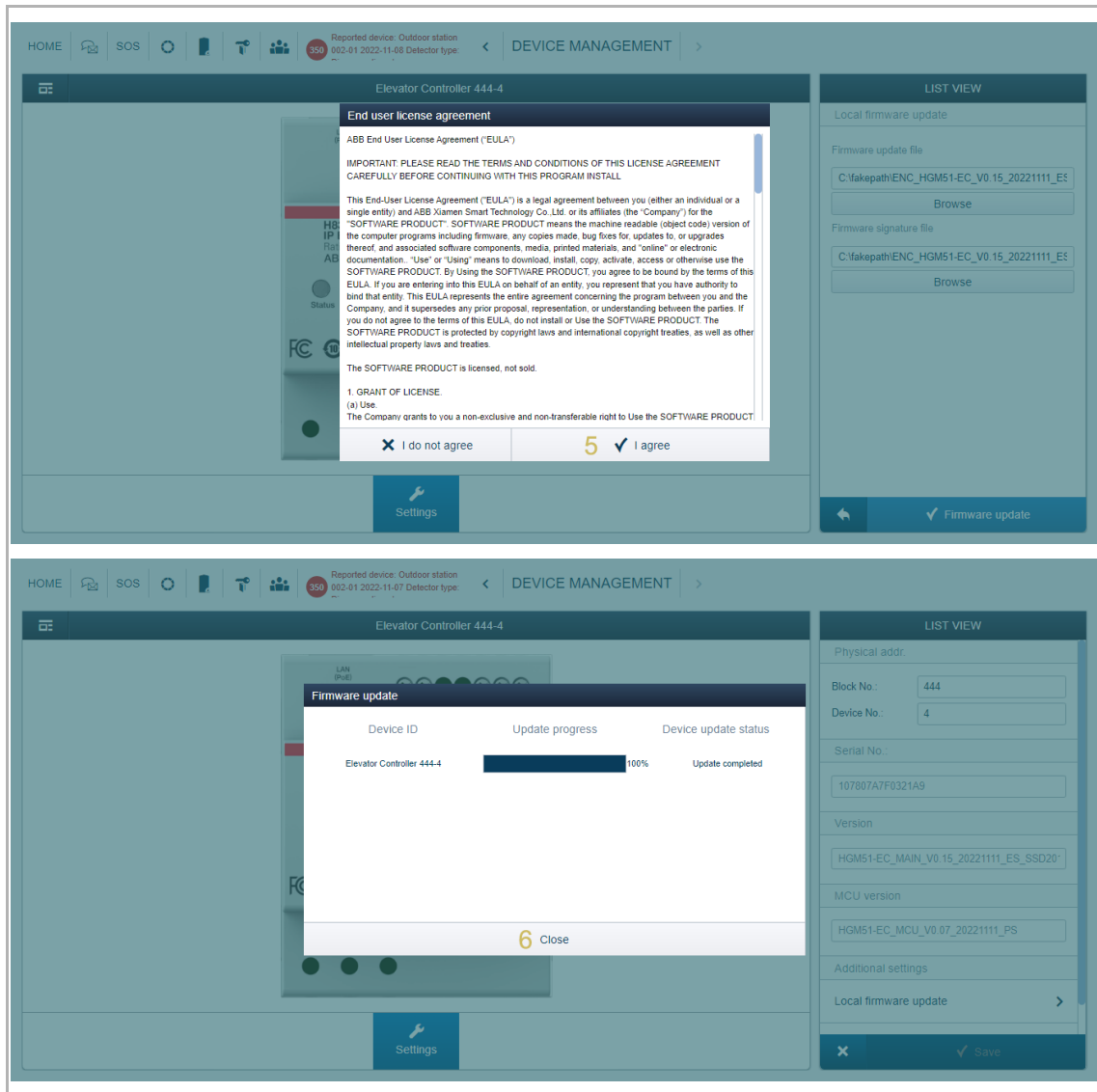

8.7.2 Updating the firmware via website

Please follow the steps below:

- [1] On the "Settings" screen, click "Online firmware update".
- [2] Current firmware version is displayed on the screen.
- [3] New firmware version will be displayed on the screen.
 - If there is no new version, "Current version is up to date" will be displayed.
 - If there is a new version, click "Save" to update the firmware.

The image shows two screenshots of the web interface for the Elevator Controller 9-1, illustrating the firmware update process.

Top Screenshot: The interface shows the "Elevator Controller 9-1" settings page. The "LIST VIEW" panel on the right displays the "Online firmware update" option with a yellow "1" next to it, indicating a new version is available. The "Current software version" is shown as "HGMS1-EC_MAIN_V0.11_20221014_ES_SSD201".

Bottom Screenshot: After clicking "Online firmware update", the interface shows the "Current software version" as "2" and the "New firmware" as "3". The "Current firmware is up to date" message is displayed, indicating the update is complete. The "Save" button is visible at the bottom right of the "LIST VIEW" panel.

8.8 Commissioning multiple devices in batches

Please follow the steps below:

- [1] On the "Elevator controller" screen,
- [2] Click "  ".
- [3] Select the designated devices.
 - When a device is pressed, the selection will be visual.
 - Click "Select all" to select all devices
- [4] Click "Next".

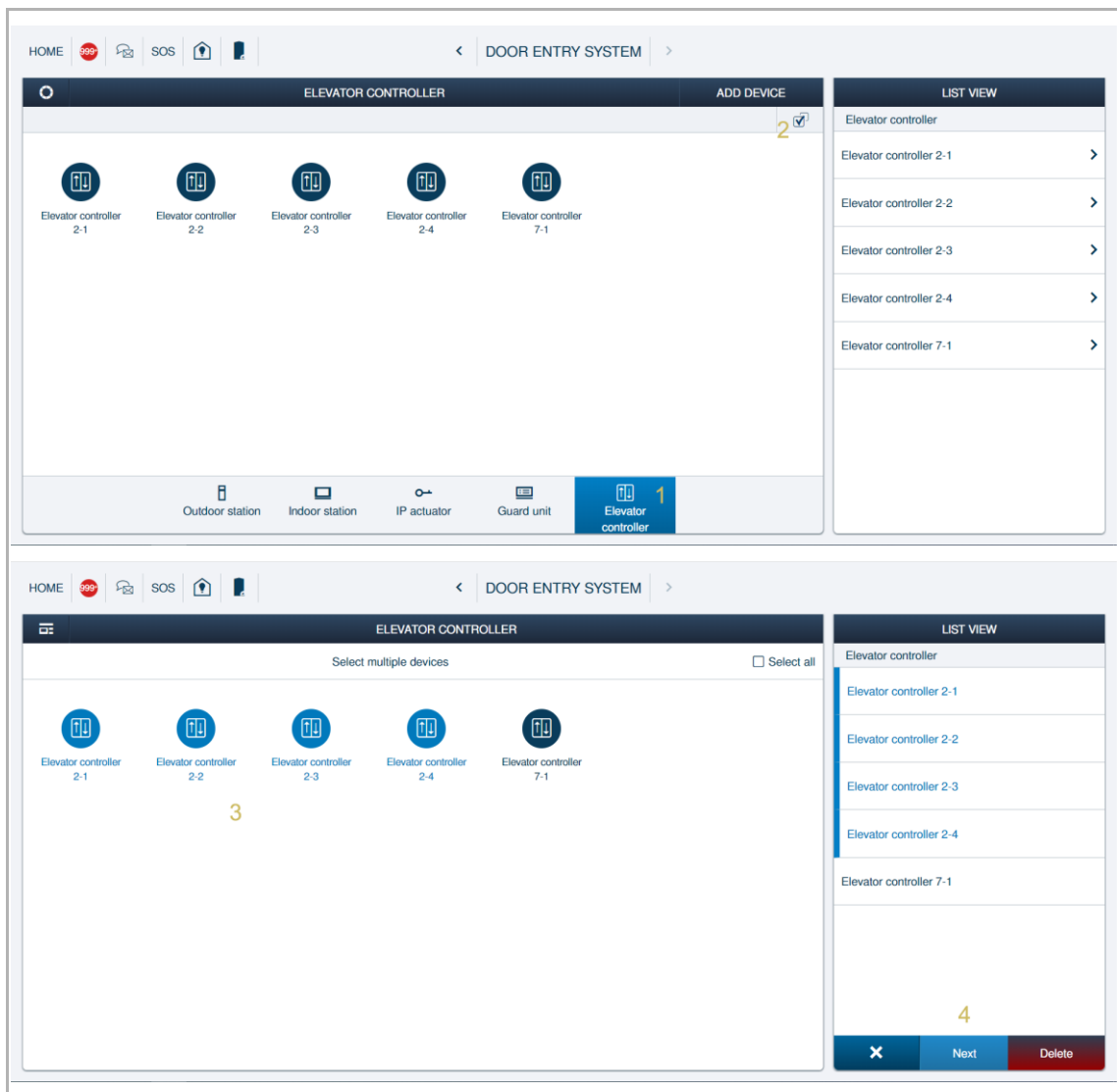

- [5] "xx devices" will be displayed on the title to indicate multiple devices are set at the same time.
- [6] There are multiple functions can be select on the "List view" menu bar. Select a function to continue the setting. The operation is the same as that of a single device.

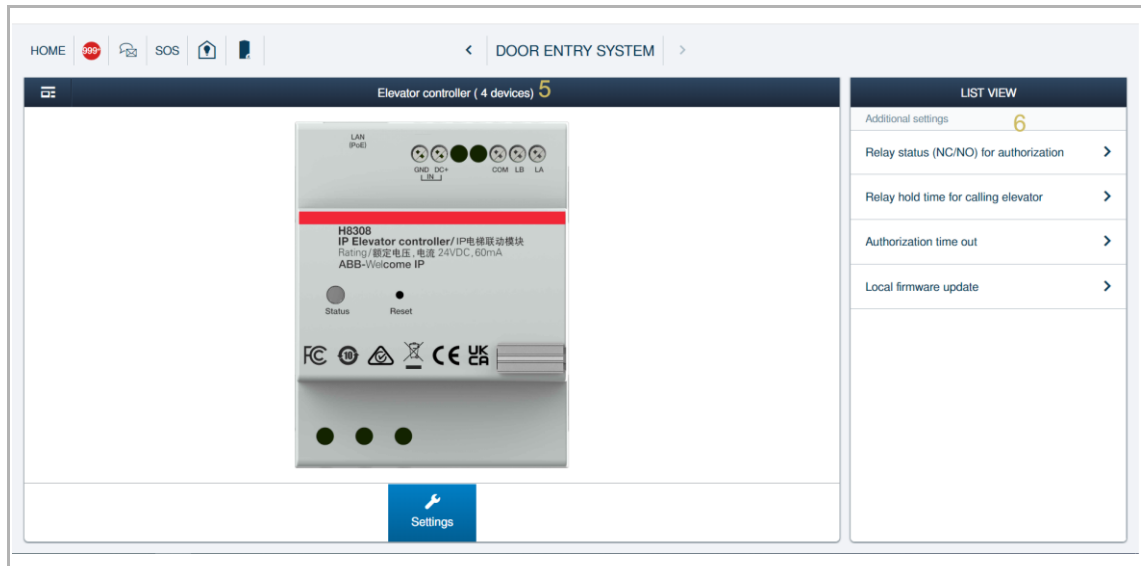

9 Cyber security

9.1 Disclaimer

H8308 product is designed to be connected and to communicate information and data via a network interface, which should be connected to a secure network. It is customer's sole responsibility to provide and continuously ensure a secure connection between the product and customer's network or any other network (as the case may be) and to establish and maintain appropriate measures (such as but not limited to the installation of firewalls, application of authentication measures, encryption of data, installation of antivirus programs, etc.) to protect the H8308 product, the network, its system and interfaces against any kind of security breaches, unauthorized access, interference, intrusion, leakage and/or theft of data or information. Busch-Jaeger Ltd and its affiliates are not liable for damages and/or losses related to such security breaches, unauthorized access, interference, intrusion, leakage and/or theft of data or information.

Although Busch-Jaeger provides functionality testing on the products and updates that we release, you should institute your own testing program for any product updates or other major system updates (to include but not limited to code changes, configuration file changes, third party software updates or patches, hardware change out, etc.) to ensure that the security measures that you have implemented have not been compromised and system functionality in your environment is as expected.

9.2 Performance and service

Network performance

Type	Value
Ethernet	100 Mbps (148,810 packets/sec)
ARP	41 Mbps (61,012 packets/sec)
ICMP	65 Mbps (92,262 packets/sec)
IP	51 Mbps (75,893 packets/sec)

Port and service

Port	Service	Purpose
7777	TCP	To be used for device management
10777	TLS	Secure channel for device management

9.3 Deployment guideline

If the user decides to remove the device from the system, the user shall reset the device to the factory default settings to remove all the configuration data and sensitive data on the device. This will prevent any sensitive data leaks.

It is recommended to apply the "MAC filter" and "Rate limiter" on the switch to prevent DOS attacks.



Note

When using the Elevator Controller in conjunction with the Relay Module, the installer must ensure that both devices are installed in the same enclosure box. The operator of the system must ensure that the enclosure box is protected against physical access by unauthorized personal.

9.4 Upgrading

The device supports firmware updates via the management software, where a signature file is used to verify the authentication and integrity of the firmware.

9.5 Backup/restore

When using the Preconfigured or Semi-automatic Configuration, please print the configuration result and save it.

When using the Manual Configuration, please export the configuration file after all configurations work has been completed.

9.6 Malware prevention solution

The H8308 device is not susceptible to malware, because custom code cannot be executed on the system. The only way to update the software is by firmware upgrading. Only firmware signed by Busch-Jaeger can be accepted.

9.7 Password rule

None

10 Notice

We reserve the right to at all times make technical changes as well as changes to the contents of this document without prior notice.

The detailed specifications agreed to at the time of ordering apply to all orders. Busch-Jaeger accepts no responsibility for possible errors or incompleteness in this document.

We reserve all rights to this document and the topics and illustrations contained therein. The document and its contents, or excerpts thereof, must not be reproduced, transmitted or reused by third parties without prior written consent by Busch-Jaeger.

Service

ABB AG – BUSCH-JAEGER
Freisenbergstr. 2, DE-58513 Lüdenscheid

BUSCH-JAEGER.de
go.abb/contact

Copyright© 2025 BUSCH-JAEGER
All rights reserved

2TMD042300D0005