

—
VER: 1.1 | 02.20.2017

ABB Welcome[®]

M21311P1-A

M21311P2-A

M21312P1-A

M21312P2-A

Mini outdoor station



ABB Welcome®

- 1 Safety..... 3
- 2 Intended use..... 3
- 3 Environment 3
 - 3.1 ABB devices..... 3
- 4 Terminal description..... 4
 - 4.1 Front overview..... 4
 - 4.2 Terminal description 5
 - 4.2.1 Lock connected with terminals 10 and 11 6
- 5 Operation 7
 - 5.1 Configure functions of the first and second pushbutton..... 7
 - 5.2 Configure functions of the general call button..... 9
 - 5.3 Round pushbutton with ID card reader..... 10
 - 5.4 Setting the language for the voice messages..... 10
- 6 Technical data 11
- 7 Mounting and installation..... 12
 - 7.1 Requirements for the electrician 12
 - 7.2 General installation instructions..... 13
 - 7.3 Mounting 14
 - 7.3.1 Preparation..... 14
 - 7.3.2 Dimension 14
 - 7.3.3 Surface mounted 14
 - 7.3.4 Dismantling 14
 - 7.3.5 Replace nameplate..... 14

1 Safety



Warning

Electric voltage!

Direct or indirect contact with live components can cause dangerous currents to flow through the body, which may result in electric shock, burns or even death.

- Always disconnect the main power supply prior to installation and/or disassembly.
- Work on the 110 V - 240 V supply system must be performed only by qualified personnel.

2 Intended use

The outdoor station is an integral part of the ABB Welcome door communication system and operates exclusively with components from this system. The device must only be used with suitable ABB flush-mounted installation sockets and rain hood.

3 Environment



Consider the protection of the environment!

Used electric and electronic devices must not be disposed of with household waste.



- The device contains valuable raw materials that can be recycled and should be disposed of at an appropriate recycling facility.

3.1 ABB devices

All packaging materials and devices from ABB bear the markings and test seals for proper disposal. Always dispose of the packing materials, electronic devices and their components via authorized collection facilities or disposal companies.

ABB Welcome[®]

4 Terminal description

4.1 Front overview

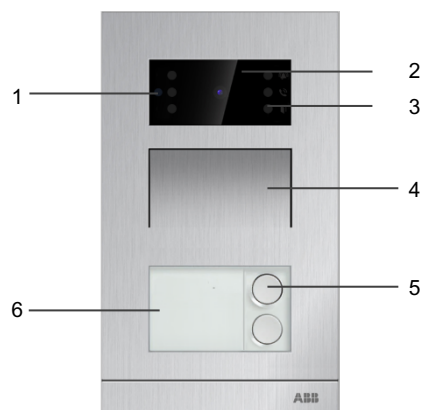

Fig. 1 Front overview

No.	Function
1	Light sensor
2	Infrared LED (total of six)
3	Indicating LED (total of three: ring, call and door open)
4	Speaker and microphone integration
5	Round pushbutton *If round pushbutton with ID card reader, see Chapter 5.3 for details.
6	Nameplate

4.2 Terminal description

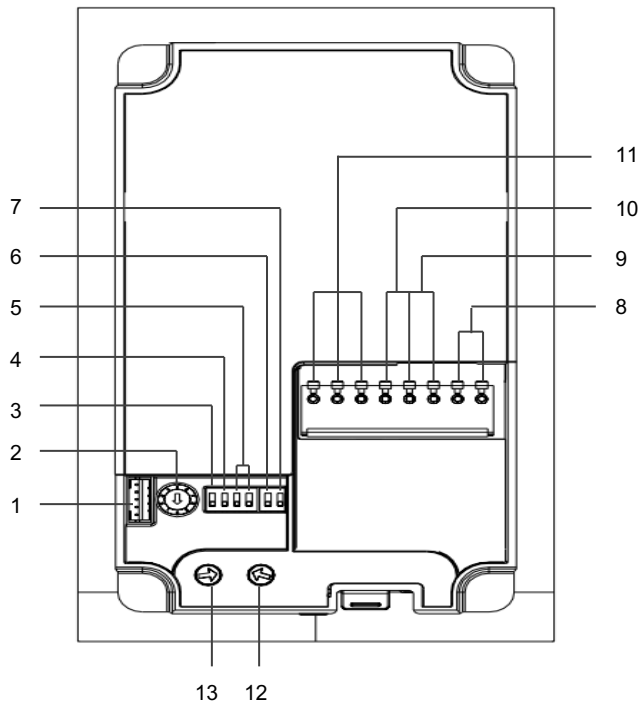







Fig. 2 Terminal description

No.	Functions
1	Connector for device software update
2	Rotary switch to set the address of outdoor station (1-9)
3	Set feedback tone of pushbutton ON/OFF
4	Set general call to all indoor stations in one family GC=ON, press button 1 and button 2, all indoor stations ring For details, see Chapter 5.2 .
5	Configuration function of first and second round pushbutton For details, see Chapter 5.1 .
6	Set the video mode to PAL or NTSC OFF=PAL video mode ON=NTSC video mode
7	Set default lock OFF= set (Lock-GND) as default lock ON= set (COM-NC-NO) as default lock *Default lock is controlled by "unlock" button on indoor station.
8	Plug-in clamps (a, b) for connection
9	Plug-in clamps (Exit-GND) for exit button
10	Plug-in clamps (Lock-GND) for door opener
11	Plug-in clamps (COM-NC-NO) for floating output, door opener
12	Rotary switch to adjust default door lock release time (1-10 seconds)
13	Rotary switch to adjust loudspeaker volume

4.2.1 Lock connected with terminals 10 and 11

Lock type	Pic	Operation type	Voltage	Wiring
Electric Strike Lock, 12V		Power supply to open.	12V DC/AC	Type A Type B
Electric Strike Lock, 24V		Power supply to open.	24V DC/AC	Type B
Electric Rim Lock, 12V		Power supply to open.	12VDC	Type A Type B
Electric mortise lock		Power on to close.	12VDC	Type C
Magnetic lock		Power on to close.	12/24VDC	Type C



ABB Welcome®

5 Operation

5.1 Configure functions of the first and second pushbutton

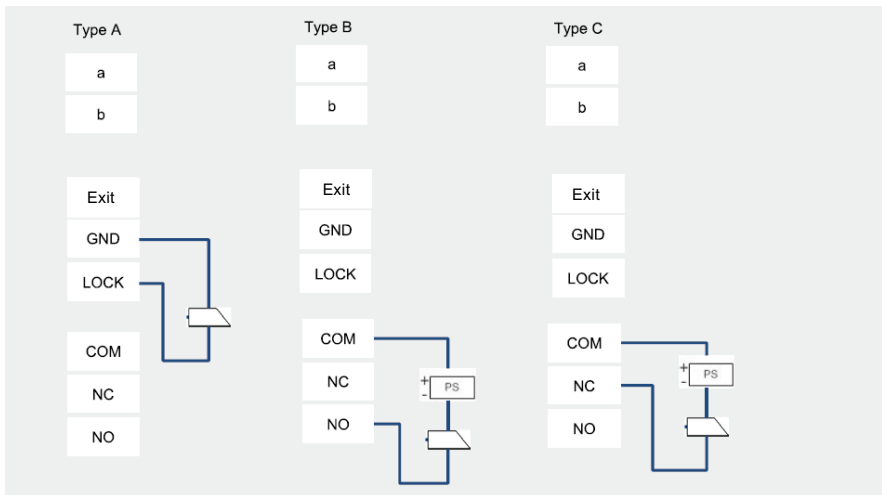
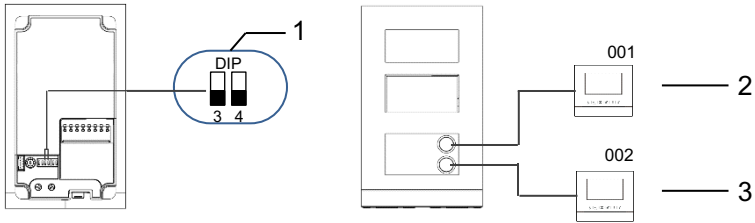
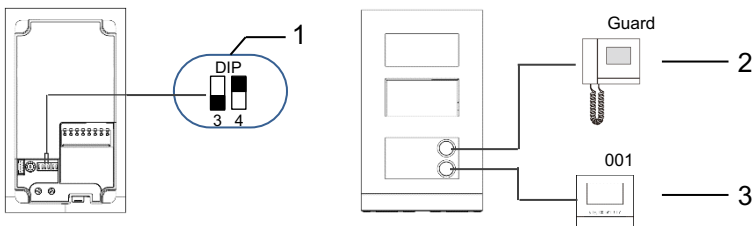
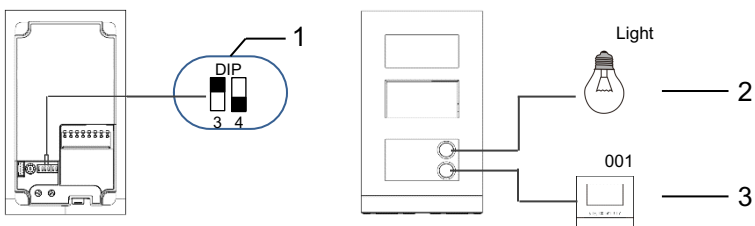

Fig. 3 Addressing

No.	Functions
1	3->OFF, 4->OFF
2	Call apartment 001
3	Call apartment 002



No.	Functions
1	3->OFF, 4->ON
2	Call guard unit
3	Call apartment 001



No.	Functions
1	3-> ON, 4->OFF
2	Switch on light
3	Call apartment 001

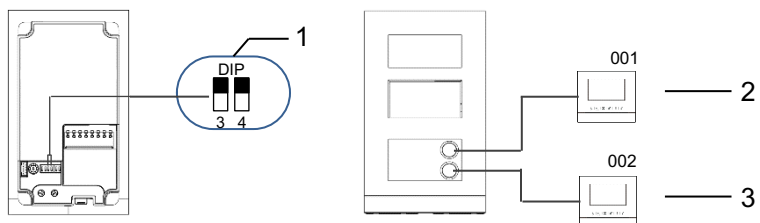

No.	Functions
1	3->ON, 4->ON
2	Call apartment 001
3	Call apartment 002

5.2 Configure functions of the general call button

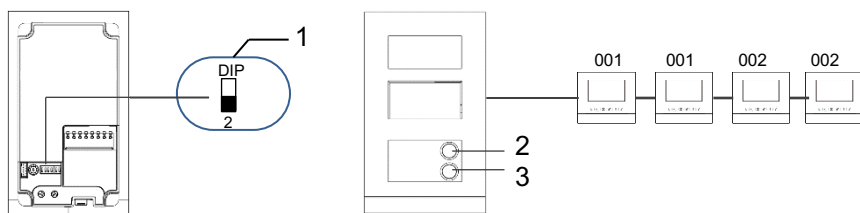

No.	Functions
1	2->OFF
2	Call apartment 001, both 001 indoor stations ring.
3	Call apartment 002, both 002 indoor stations ring.

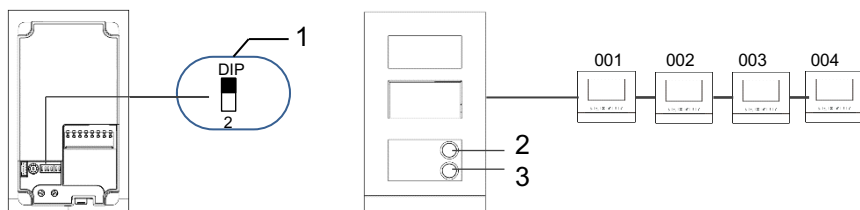



No.	Functions
1	2->ON
2	Call apartment, all four indoor stations (different addresses) ring.
3	Call apartment, all four indoor stations (different addresses) ring.

* If the "call forward function" has been set at the indoor station, this function will not work well. For example, if 001IS has set call forward to 002 IS: When you press first round pushbutton on the outdoor station to call 001 IS, if 001 IS doesn't answer the call in 5 seconds, it will not transfer to 002 IS.

ABB Welcome®

5.3 Round pushbutton with ID card reader

Programming

Function	Command	Indicating LED for door open
Create admin card	Swipe card 1x	Green 
Enter settings	Swipe admin card 1x	Orange 

The system will designate the first card swiped within 60 seconds after powering up the system to be the admin card. After entering the settings, the following functionalities can be implemented:

Function	Command	Indicating LED for door open
Enroll user	Swipe admin card 1x	Orange flash 1x
	Swipe card (new user) 1x	Green
Delete user	Swipe admin card 2x	Orange flash 2x
	Swipe card (user x) 1x	Green
Enroll new admin	Swipe admin card 3x	Orange flash 3x
	Swipe card (new admin) 1x	Green
Delete admin	Swipe admin card 4x	Orange flash 4x
	Swipe card (admin x) 1x	Green
Delete all users	Swipe admin card 5x	Orange flash quickly
	Swipe admin card 1x	Green

During setting, please swipe the same admin card.

Function	Command	Indicating LED for door open
Exit settings	Swipe admin card 1x or no cards swiped within 15 seconds	—

Open a door

Function	Command	Indicating LED for door open
Open a door	Swipe the enrolled keycard	Green

Reset to factory default

Function	Command	Indicating LED for door open
Reset to factory default	Disconnect the power supply. Set rotary switches of address to "0" and set all the dip-switches to "OFF." Reconnect the power supply. Long press the 1st button for 3 seconds. Finish.	— — — Green Red, green, orange cycle —

Technical specifications

Work frequency	125 KHz
Standard	ISO18000-2
Support card	EM4100, EM4205, EM4305, EM4450, TK4100, T5567

5.4 Setting the language for voice messages

When outdoor station power is on;

1. Set outdoor station address as "0" and switch all the dip-switches to "ON."
2. Long-press the first button for 3 seconds to play the voice message.
 - If in English, an English voice will be played.
 - If in French, a French voice will be played.
 - If a beep sound is played, it means the voice synthesis function is disabled.
3. Short press the first button to change the language.
4. After choosing desired language, long-press the first button to save and exit.

6 Technical data

Designation	Value
Operating temperature	-40 °F to +158 °F
Protection (cover frame assembled)	IP 54
Power supply, door opener (Lock-GND)	12 V DC, 250 mA
Floating output, door opener (COM-NC-NO)	30 V AC or DC, 1 A
Single-wire clamps	2 x 22 AWG - 2 x 18 AWG
Fine-wire clamps	2 x 22 AWG - 2 x 18 AWG
Bus voltage	20 V - 30 V

7 Mounting and installation



Warning

Electric voltage!

Direct or indirect contact with live components can cause dangerous currents to flow through the body, which may result in electric shock, burns or even death.

- Always disconnect the main power supply prior to installation and/or disassembly.
- Work on the 110 V - 240 V supply system must be performed only by qualified personnel.

7.1 Requirements for the electrician



Warning

Electric voltage!

Install the device only if you have the necessary qualifications.

- Incorrect installation endangers your life and that of the user of the electrical system.
- Incorrect installation can cause serious damage to property, such as a fire.

The minimum necessary expert knowledge and requirements for the installation is as follows:

- Apply the "five safety rules" (DIN VDE 0105, EN 50110):
 1. Disconnect from power source.
 2. Secure against being re-connected.
 3. Ensure that there is no voltage.
 4. Connect to the earth.
 5. Cover or barricade adjacent live parts.
- Wear suitable personal protective clothing.
- Use only suitable tools and measuring devices.
- Check the type of supply network (TN system, IT system, TT system) to secure the following power supply conditions (classic connection to ground, protective grounding, necessary additional measures, etc.).

7.2 General installation instructions

- Terminate all branches of the wiring system via a connected bus device (e.g., indoor station, outdoor station, system device).
- Do not install the system controller directly next to the bell transformer or other power supplies (to avoid interference).
- Do not install the wires of the system bus together with 100 V - 240 V wires.
- Do not use common cables for the connecting wires of the door openers and wires of the system bus.
- Avoid bridges between different cable types.
- Use only two wires for the system bus in a four-core or multi-core cable.
- When looping, never install the incoming and outgoing bus inside the same cable.
- Never install the internal and external bus inside the same cable.



The following installation situations must be avoided without fail:

- Direct light
- Direct sunlight
- Extremely bright picture background
- Highly reflective walls on the opposite side of the door station
- Lamps or direct light sources

ABB Welcome®

7.3 Mounting

7.3.1 Preparation



Use gloves to protect your hands from laceration.

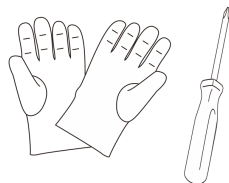

7.3.2 Dimensions

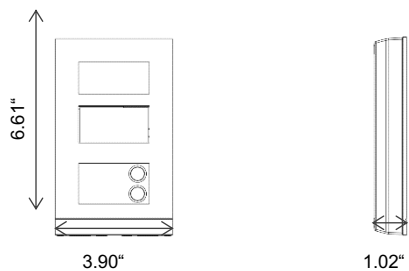

7.3.3 Surface mounted

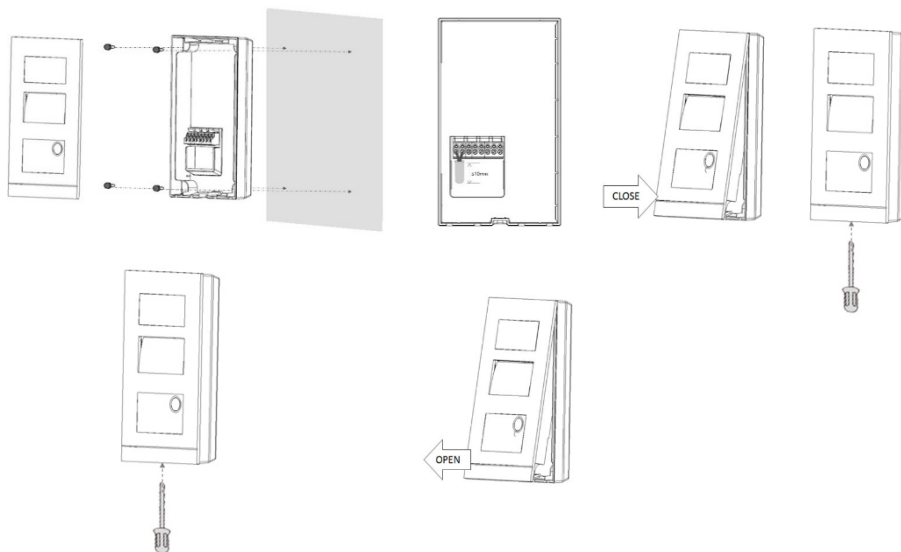

7.3.5 Replace nameplate

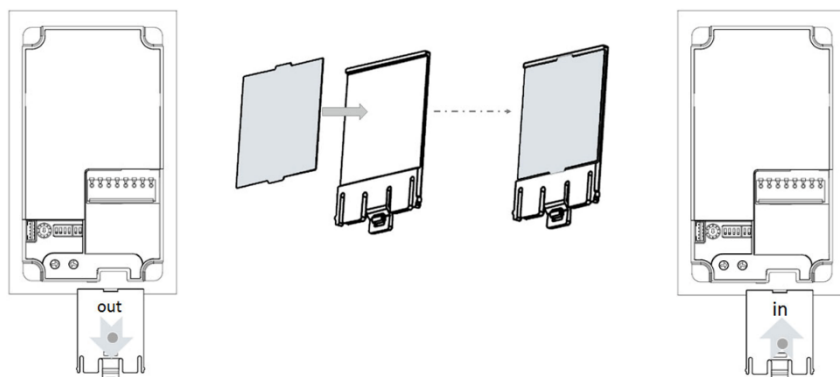



—

ABB Inc.

Electrification Products
860 Ridge Lake Blvd.
Memphis, TN 38120
www.abb.com/door-entry-system-us
abbwelcomeinfo@us.abb.com

Customer Service: 800-816-7809
7:00 a.m. - 5:30 p.m., CST, Monday-Friday
elec_custserv@tnb.com

Technical Support: 888-385-1221, Option 1
7:00 a.m. - 5:00 p.m., CST, Monday-Friday
lvps.support@us.abb.com

—

We reserve the right to make technical changes or modify the contents of this document without prior notice. With regard to purchase orders and/or contracts, the agreed particulars shall prevail. ABB Inc. does not accept any responsibility whatsoever for potential errors or possible lack of information in this document.

We reserve all rights in this document and in the subject matter and illustrations contained therein. Any reproduction, disclosure to third parties or utilization of its contents - in whole or in parts - is forbidden without prior written consent of ABB Inc.

© Copyright 2018 ABB. All rights reserved.