

TGE5, TGE5-Ex

Transmitter
for angular position

Operating instructions

42/14-33 EN

Rev. 04



Contents	Page
Applications and description	4
1 Mounting and connection	4
1.1 Parts supplied with the unit	4
1.2 Mounting location	4
1.3 Mounting	5
1.4 Connection	8
2 Commissioning	11
2.1 Setting of the lower-range and upper-range values	12
2.2 Changing the measuring range	14
2.3 Variation of the output current	16
2.4 Changing the sense of rotation	17
3 Repairs	21
4 Appendix	22
Description	22
Differential capacitor K	25
Technical data	26
5 Packing instructions	32

Important instructions!
They must absolutely be read and obeyed!

Proper and safe operation of the TGE5 (-Ex) transmitter presupposes that it is correctly transported and stored, installed and commissioned by experts and carefully operated and maintained.

Only those persons conversant with the installation and commissioning of similar equipment and who possess the necessary qualifications may work on the apparatus. They must observe the contents of these Operating Instructions and the relevant safety regulations for installation and operation of electrical apparatus.

This apparatus has been designed and tested in accordance with IEC 1010-1 (according to DIN EN 61010-1 and DIN VDE 0411 part 1) „Safety requirements for electrical measurement, control and laboratory equipment“, and has been supplied in a safe condition. To retain the apparatus in safe condition, the safety instructions with the title „DANGER“, „WARNING“, „CAUTION“ or „NOTICE“ in these Operating Instructions must be observed. Failure to comply with these safety instructions can result in death, severe bodily injuries and considerable damage to the apparatus itself or to other equipments.

Should the information given in these Operating Instructions prove to be inadequate at any time please consult the Technical Branch Office, subsidiary, or representative of ABB in your area.

The industrial standards and regulations (e.g. DIN, VDI, VDE) as well as the directives, specifications and requirements governing explosion protection (e.g. ExV, EX-RL, VDE, DIN EN) referred to in these Operating Instructions are valid in Germany. When using this device in other countries the appropriate and valid national regulations must be observed.

Applications and description

The TGE 5 (-Ex) transmitter is used for the analog measurement of rotational angles. It transforms the angular position into a load-independent, direct current of either 0...20 mA or 4...20 mA.

1 Mounting and connection

1.1 Parts supplied with the unit

Three brackets are supplied with the TGE 5 (-Ex) transmitter as accessories. A further option is 1 set of fixing material to manometer (Catalog No. 373318).

1.2 Mounting location

The TGE 5 (-Ex) transmitter may be installed in any chosen position fixed to the rotational angle sensor. Care must be taken that the potentiometer can be accessed for balancing purposes

The TGE 5 transmitter must be kept within the ambient temperature range $-25...+80\text{ }^{\circ}\text{C}$.

The TGE 5-Ex transmitter is approved for intrinsic safety classes EEx ib IIC T6 and EEx ib IIC T4.

Mounting in hazardous areas of Zones 1 and 2 is possible with

- Temperature class T6:
permissible range of ambient temperature $-25\text{ }^{\circ}\text{C}...+40\text{ }^{\circ}\text{C}$
- Temperature class T4:
permissible range of ambient temperature $-25\text{ }^{\circ}\text{C}...+70\text{ }^{\circ}\text{C}$

1.3 Mounting

(see Fig. 1-1, Fig. 1-2 , Fig. 1-3 and Fig. 1-4)

DANGER

When mounting the TGE 5-Ex transmitter, the provisions of the regulation governing electrical apparatus in hazardous areas (ElexV), the provisions of DIN EN 60079 (DIN VDE 0165 part 1) for the installation of electrical apparatus in hazardous workshops and the EC-Type-Examination Certificate PTB 03 ATEX 2118 must be observed.

1. The TGE 5 (-Ex) transmitter is to be mounted onto the rotational angle sensor in such a way that the shafts of both units are aligned as exactly as possible.

Notice

The shafts of both units may only be joined via a coupling which is free of both forces and play. This coupling must permit a certain degree of movement in a longitudinal direction and perpendicular to the axis as well as an angular offset.

2. Insert the three brackets in the continuous groove of the housing and tighten them.

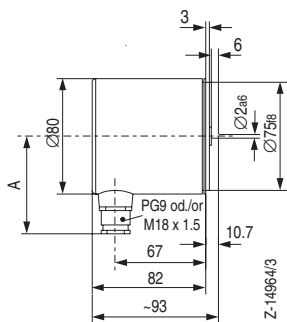
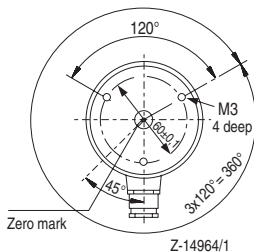

Drilling diagram for clamps

Version with plug connection

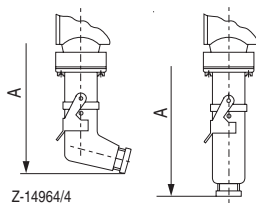
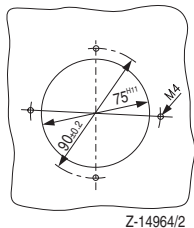

	Cable entry		Plug connection	
	D46320-C4-Pg9-7-7	D89280-KM18x1,5-Z10	angled	straight
A	62	97	132	146

Fig. 1-1 Dimensional drawing of TGE5 (-Ex)
(all dimensions in mm)

Mounting hardware

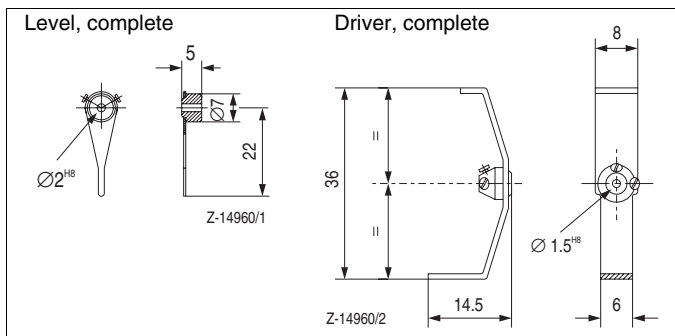

Fig. 1-2 Dimensional drawing of play-free coupling (all dimensions in mm)

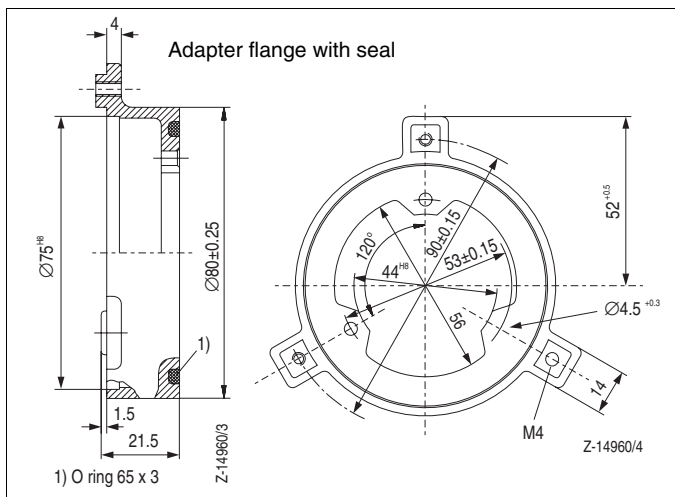

Fig. 1-3 Dimensional drawing of the attachment set for pressure gauges (all dimensions in mm)

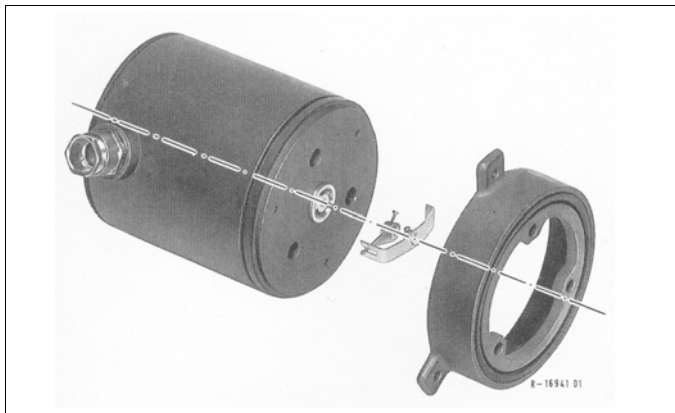

Fig. 1-4 Mounting to a pressure gauge

1.4 Connection

(See Fig. 1-5 and Fig. 1-6)

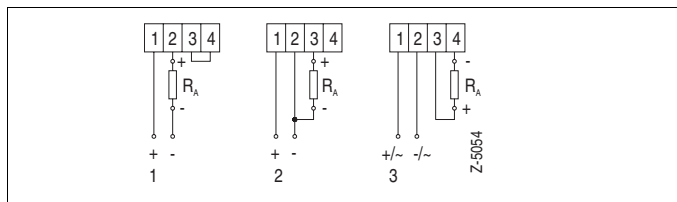

Fig. 1-5 Connection diagrams

- 1 2-wire circuits
- 2 3-wire circuits
- 3 4-wire circuits

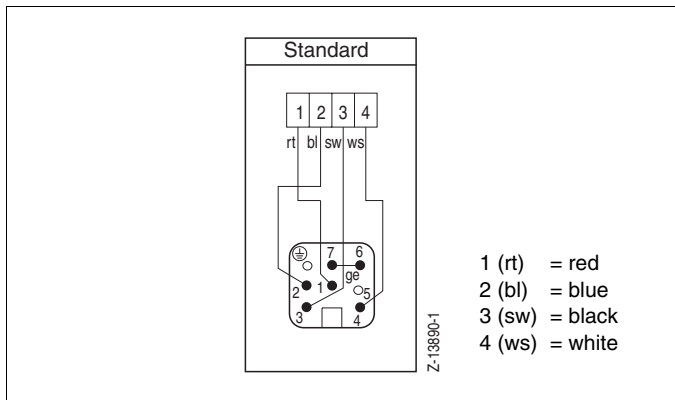

Fig. 1-6 Han 7D connector

NOTICE

The transmitter may only be operated at safety-low voltages with electrical isolation against higher mains voltage.

The transmitter will not deliver an output signal if the polarity of the supply voltage is incorrect.

In models without electrical isolation, the supply and output current circuits are provided with a common minus potential through internal connection (terminals 2 and 4).

The requirements of DIN VDE 0100 must be met when selecting line material and laying measuring and output signal lines.

DANGER

The provisions of DIN EN 60079-14 (DIN VDE 0165 part 1) must additionally be adhered to when connecting the TGE 5-Ex.

Connections:

- Screw terminals for 2.5 mm² wire
- Han 7D connector (not for Ex version)

Connection of screw terminals

1. Determine the correct power supply for the unit from the rating plate.
2. Remove the screw using a screwdriver (blade width 5 mm) and take off the housing cover.
3. Secure the wires (max. cross section 2.5 mm²) in the screw terminals with a screwdriver (blade width 3 mm).
4. Replace the housing cover and fasten with screws.

The TGE 5-Ex transmitter must be supplied with power through a current circuit which is certified as intrinsically safe (EEx ib IIC). See Fig. 1-7.

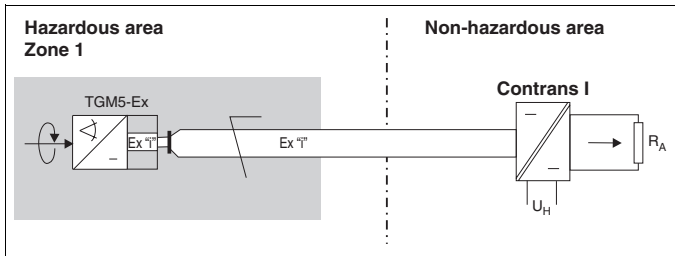

Fig. 1-7 An example of the use of the TGE5-Ex

2 Commissioning

DANGER

Before switching on the power supply, the operating voltage of the unit (see rating plate) must be checked to ensure it conforms to the mains voltage.

For adjustment and calibration works on the TGE 5-Ex, please observe the chapter on explosion protection under „Technical data“.

The TGE 5 transmitter is factory set to an output current of 0...20 mA and a 3-wire/4-wire circuit or as specified in the order. The output current may be switched to 4...20 mA by repositioning the jumper Br3 (see Fig. 2-1).

Jumper Br3 switchable

Open



4 ... 20 mA

Closed



0 ... 20 mA

The TGE 5-Ex transmitter is factory set to an output current of 4...20 mA and a 2-wire circuit.

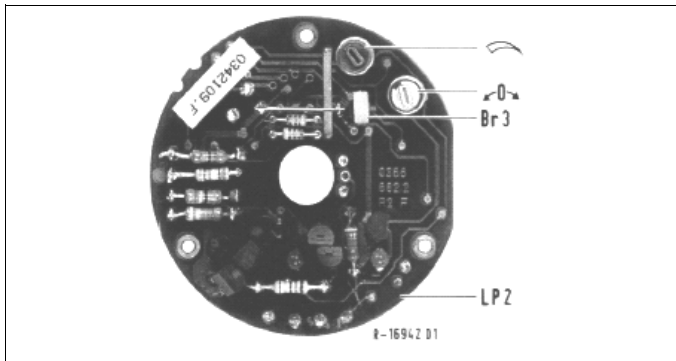

Fig. 2-1 Printed circuit board with LP2 electronics



Potentiometer for setting the lower-range value



Potentiometer for setting the upper-range value

Br3

Jumper for adjusting the output current

2.1 Setting of the lower-range and upper-range values

The lower-range value of the transmitter is marked on the rotor of the shaft and on the flange supports of the case. Coupling must be secured in such a way that both markings correspond when in the desired position of the case. A plastic nipple is arranged on the other side of the shaft to help setting (can be seen when case cover is opened).

Notice

A screwdriver (blade width 3 mm) must be used to set the lower-range and upper-range values to avoid damaging the potentiometer.

1. Set the rotational angle sensor to the lower-range value setting.
2. Remove the screw using a screwdriver (blade width 5 mm) and take the housing cover off the transmitter.
3. Remove the fixing screws.

Note

If the transmitter is secured in position using the 3 tapped bores in the base of the housing, the lower-range value may be set by rotating the coupling on the shaft.

4. Twist the housing of the transmitter until the output current rises to 0...0.3 mA or 4...4.3 mA.
5. Insert the three brackets in the peripheral groove of the case and tighten them.
6. Set the lower-range value to 0 or 4 mA using the  potentiometer.
 - Turning the potentiometer anti-clockwise causes the current to drop
 - Turning the potentiometer clockwise causes the current to rise.

Note

If the potentiometer has reached the limit position, return it to its central position and repeat the settings in Nos. 4 and 5.

7. Set the rotational angle sensor to the upper-range value setting.
8. Set the upper-range value to 20 mA with the  potentiometer.
9. Reset the lower-range and upper-range values and check them.
10. Close the housing cover of the transmitter.

2.2 Changing the measuring range

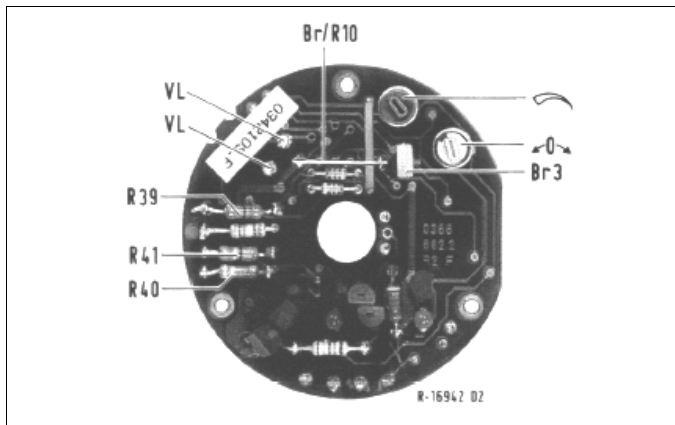

Fig. 2-2 Printed circuit board with LP2 electronics



Potentiometer for setting the lower-range value



Potentiometer for setting the upper-range value

Br3 Jumper for adjusting the output current

R39

R40

R41

3 resistors R39, R40 and R41 for matching the electronics to the chosen measuring range (capacitor type 1 to 5)

VL Connection lines between the differential capacitor and the soldering terminals

Br /R10 Jumpers for adjusting the output current

NOTICE

A screwdriver (blade width 3 mm) must be used to set the measuring range to avoid damaging the potentiometer.

1. Set the rotational angle sensor to the lower-range value setting.
2. Remove the screw using a screwdriver (blade width 5 mm) and take the housing cover off the transmitter.
3. Remove the brackets.

Note

If the transmitter is secured in position using the 3 tapped bores in the base of the case, the lower-range value may be set by rotating the coupling on the shaft.

4. Twist the housing of the transmitter until the output current rises to 0...0.3 mA or 4...4.3 mA.
5. Insert the three brackets in the peripheral groove of the case and tighten them.
6. Set the lower-range value to 0 or 4 mA using the  potentiometer.
 - Turning the potentiometer anti-clockwise causes the current to drop.
 - Turning the potentiometer clockwise causes the current to rise.

Note

If the potentiometer has reached the limit position, return it to its central position and repeat the settings in Nos. 5 and 6.

7. Set the rotational angle sensor to the upper-range value setting.
8. Set the potentiometer  to the central position.
9. Unsolder the R40 resistor and replace it with a decade resistor.
10. Using the decade resistor, set the output signal to an upper range value of 20 mA.
11. Read the resistance value off the decade resistor and solder in position as a fixed resistance in place of the R40.
12. Check the lower-range and upper-range values several times.
13. Close the housing cover of the transmitter.

2.3 Variation of the output current

The output current may be varied by means of the jumper Br3 and fixed-value resistor R10 (see Table 2-1 below).

Output current	Type of connection	Jumper Br3	Resistor Br/R10
0...20 mA	3- or 4-wire circuit	closed	Jumper
4...20 mA	2- or 4-wire circuit	open	Jumper
0...10 mA	3- or 4-wire circuit	closed	35.7 Ω
0... 5 mA	3- or 4-wire circuit	closed	110 Ω

Table 2-1

Note

Output current 4...20 mA , 4-wire circuit, can not be modified.

2.4 Changing the sense of rotation

(see Fig. 2-3 to Fig. 2-8)

As can be seen from Fig. 2-3 to Fig. 2-8, the TGE 5 (-Ex) transmitters have up to 6 direct action and reverse action characteristics, depending on the measuring range of the capacitor which is fitted.

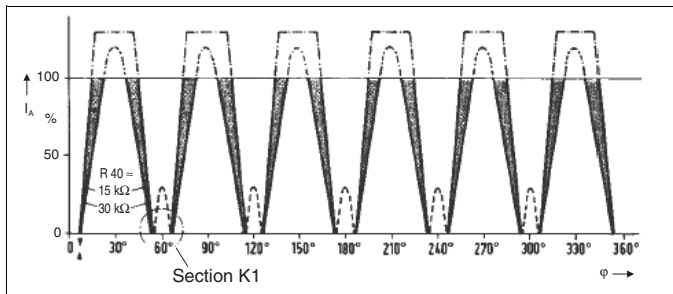

Fig. 2-3 Capacitor type K1
Measuring range: min. 0...7,5° / max. 0...17°

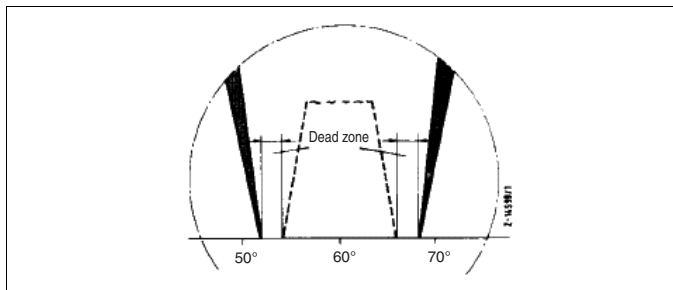

Fig. 2-4 Section K1

- Usable characteristic
- - - Zone not usable
- · - · Saturated output signal
- Setting ranges
- ▼ Lower-range value marker

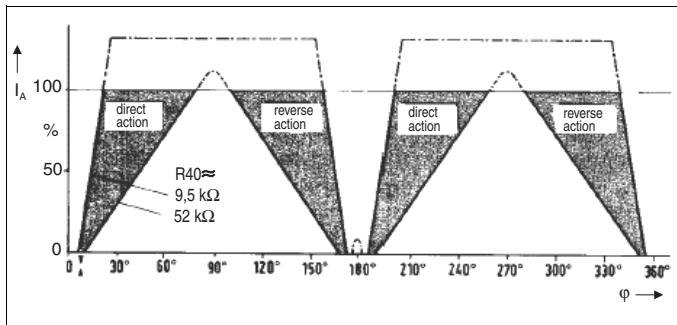

Fig. 2-5 Capacitor type K2
Measuring range: min. 0...15°/max. 0...75°

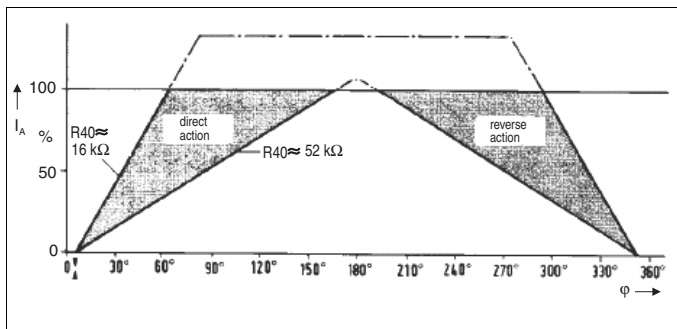

Fig. 2-6 Capacitor type K3
Measuring range: min. 0...60°/max. 0...165°

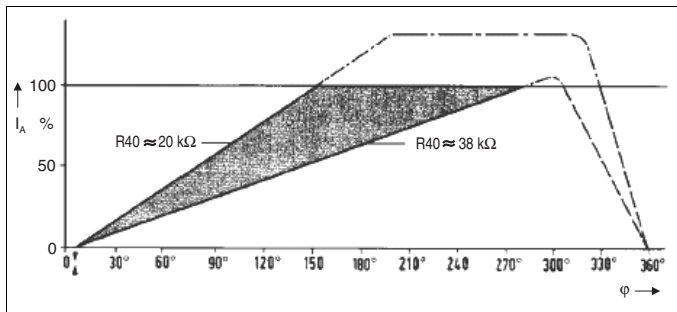

Fig. 2-7 Capacitor type K4
Measuring range: min. 0...150°/max. 0...280°

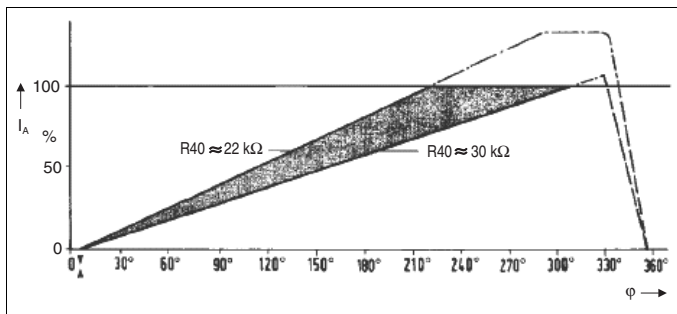

Fig. 2-8 Capacitor type K5
Measuring range: min. 0...220°/max. 0...310°

The measuring ranges

- min. 0... 7,5° /max. 0... 17° (capacitor type K1),
- min. 0...15° /max. 0... 75° (capacitor type K2) and
- min. 0...60° /max. 0...165° (capacitor type K3)

may be switched from clockwise to anti-clockwise and vice versa by rotating the housing or the shaft in the opposite direction to that specified on the rating plate.

The following changes must additionally be carried out for the measuring ranges

min. 0 ... 150° / max. 0 ... 280° (capacitor type K4) and
 min. 0 ... 220° / max. 0 ... 310° (capacitor type K5)

- The connection lines between the differential capacitor and the soldering terminals on the LP2 have to be resoldered (see Fig. 2-2 page 14).

Straight connection lines: shaft rotates clockwise

Crossed connection lines: shaft rotates anti-clockwise

Note

The sense of rotation specified on the rating plate relates to that of the shaft. The transmitter delivers a rising output signal whether rotation is in a clockwise or anti-clockwise direction.

- The R39, R40 and R41 resistors must be set as specified in the following tables.

Measuring range		Sense of rotation	
		clockwise	anti-clockwise
min. 0...150° max. 0...280°	R41 200 kΩ	R39 42.2 kΩ	R39 24.9 kΩ
	200 kΩ	45.3 kΩ	18.2 kΩ

Measuring range	Sense of rotation	
	clockwise	anti-clockwise
0...180°	R40 25.5 kΩ	R40 20.5 kΩ
0...270°	36.5 kΩ	30.1 kΩ
0...310°	31.6 kΩ	23.2 kΩ

3 Repairs

DANGER

Working on an explosion-protected unit is only permitted after elimination of the explosion hazards.

Before recommissioning the device must be tested and approved by an expert.

This is not necessary if the work was executed by personnel authorized by the manufacturer. The fitter must carry respective identification. After the repair the fitter must attach a date and code to the repaired device.

These instructions do not apply to lower-range and upper-range value adjustment.

These works can also be executed by the user in a hazardous area if the required safety rules are observed.

The unit must be disconnected from all voltage sources before maintenance work is carried out or parts replaced which necessitate that the unit be opened.

Whenever it is likely that protection has been impaired, the unit must be rendered inoperative and secured against any unintended operation.

It must be assumed that the protection has been impaired when

- the unit bears visible signs of damage
- the unit no longer functions
- the unit has been stored under unfavourable conditions for a long period of time
- the unit has been subjected to adverse transport conditions.

The TGE 5 transmitter is fitted with protective diodes to protect it and the peripheral units from damage. These are so-called TAZ suppressor diodes which are fitted to limit superimposed parasitic voltage peaks of the power supply. If the protective diodes are destroyed by overloading, a short-circuit in the input will result and the diodes need to be replaced.

4 Appendix

Description

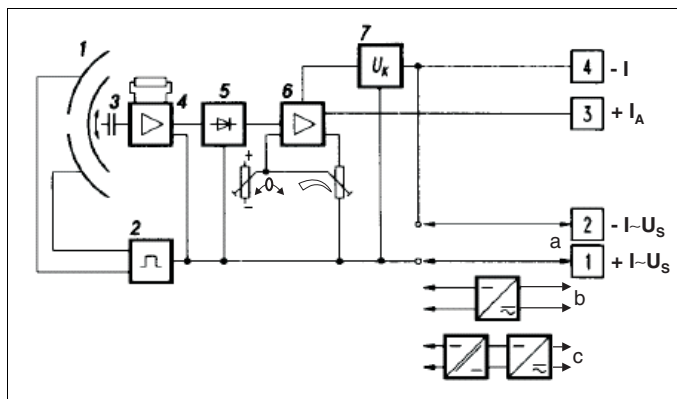

Fig. 4-1 Block diagram

- a Direct current version
- b UC version
- c UC version with electrical isolation
- U_s Power supply
- I_A Output current

The function of the TGE 5 (-Ex) transmitter relies on a capacitive process for the non-contact measurement of rotational angles which is virtually free of wear and tear and reaction. The shaft of the transmitter rotates freely.

The rotational angle to be measured is transferred to the rotor of the differential capacitor 1 via a mechanical coupling. The oscillator 2 feeds the differential capacitor with a constant alternating current. The alternating voltage, proportional to the angular position, is measured and fed to the pre-amplifier 4 via a coupling capacitor 3. This alternating voltage is rectified by the rectifier 5 and transformed into a load-independent, direct current I_A , in the amplifier 6. The constant voltage

source 7 is fed by an external power supply and provides the oscillator and amplifier with a stabilized voltage.

The TGE 5 (-Ex) transmitter comprises a housing and a measuring insert.

The housing of the TGE 5 (-Ex) transmitter is a cylinder of aluminium with the free end of the shaft projecting through the base. The free end of the shaft has a diameter of 2 mm.

The measuring insert contains the following components:

- A differential capacitor
- A printed circuit board (LP2) with electronics and
- A printed circuit board (LP1) with connections.

The components are mounted on a flange through three set screws.

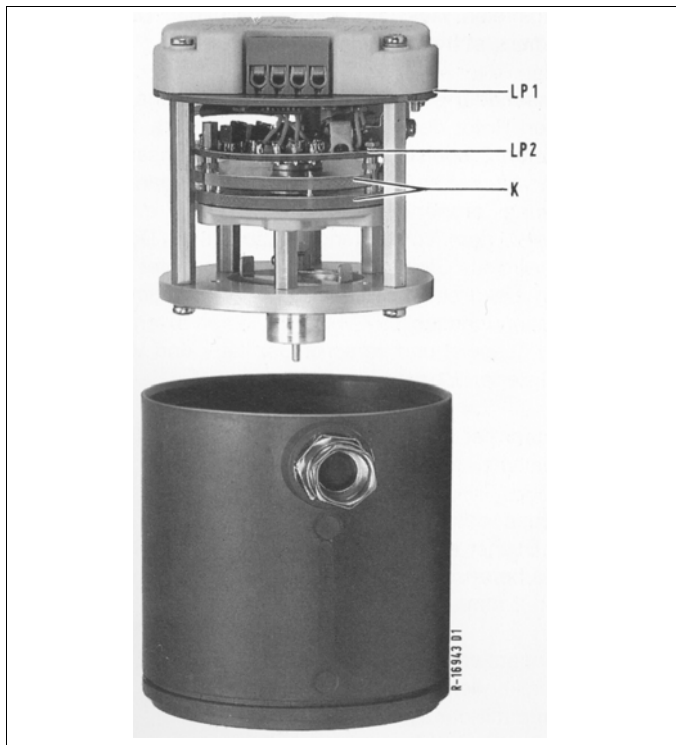



Fig. 4-2 The construction of the TGE5 (-Ex) transmitter
LP1 Printed circuit board with connections
LP2 Printed circuit board with electronics
K Differential capacitor

Differential capacitor K

There are 5 standard capacitor types K1 ... K5 for the setting of a measuring range. A rotor revolves between the two stator plates of the capacitor. The angular position is picked up by the rotor in a non-contact manner and fed to the electronics section via the coupling capacitor.

Printed circuit board LP2 with electronics

- Potentiometer for setting the lower range value 
- Potentiometer for setting the upper range value 
- Jumpers Br3 and Br/R10 for adjusting the output current
- 3 resistors, R39, R40 and R41 for matching the electronics to the chosen measuring range (capacitor type)

Printed circuit board LP1 with connections

Non-Ex version TGE5

- UC power supply unit
- EMC protection circuit
- Electrical isolation (optional)

Ex version TGE5-Ex

- Power-limited components
- EMC protection circuit

Technical data

Input

Standard measuring ranges

min. 0... 9°/max. 0... 11°, set to 0... 10°
min. 0... 27°/max. 0... 33°, set to 0... 30°
min. 0... 54°/max. 0... 66°, set to 0... 60°
min. 0... 81°/max. 0... 99°, set to 0... 90°
min. 0...162°/max. 0...198°, set to 0...180° 1)
min. 0...243°/max. 0...280°, set to 0...270° 1)
0...310°¹⁾

Special measuring ranges

min. 0... 7.5° /max. 0... 17°
min. 0... 15° /max. 0... 75°
min. 0... 60° /max. 0...165°
min. 0...150° /max. 0...280° 1)
min. 0...220° /max. 0...310° 1)

Zero

Approx. $\pm 5\%$ adjustable (referred to the output span)

Shaft

can be freely rotated

- 1) Clockwise rotation, rising output current,
for anti-clockwise rotation see Data Sheets

Output and power supply

Non-linearity

< 1 % (referred to the output span)
measuring range < 90°:
< 0.5 % (referred to the output span)

Response time

< 50 ms (jump 0 %...100 %)

Long-term influence

< 0.2 % / year

Residual ripple (peak-peak)

Output signal < 1 %
Power supply < 1.5 V

Output and power supply

Electrical isolation	Power supply U_s	Max. current supply	Max. load	2-wire connection	3-wire connection	4-wire connection	Jumper Br3
without (only Ex version)	12...20 V DC	24 mA	$\frac{(U_s - 12V)}{I_A}$	4...20 mA	—	—	open
without	13.2...36 V DC	24 mA	$\frac{U_s - (13, 2V)}{I_A}$	— — 4... 20 mA	0... 5 mA 0... 10 mA 0...20 mA	0... 5 mA 0... 10 mA 0...20 mA ³⁾ 4...20 mA ³⁾	closed closed closed open
without	13.2...26.4 V AC	24 mA	$\frac{U_s - (13, 2V)}{I_A} \times 1, 4$	— — — —	— — — —	0... 5 mA 0... 10 mA 0...20 mA ³⁾ 4...20 mA ³⁾	closed closed closed open
with	13.2...36 V DC	100 mA	600 Ω	— — — —	— — — —	0... 5 mA 0... 10 mA 0...20 mA ⁴⁾ 4...20 mA ⁴⁾	closed closed closed open
with	13.2...26.4 V AC	100 mA	600 Ω	— — — —	— — — —	0... 5 mA 0... 10 mA 0...20 mA ⁴⁾ 4...20 mA ⁴⁾	closed closed closed open
3) only version V1443xA-xx7xxxx 4) only version V1443xA-xx73xxx							

General and safety data

Environment conditions

See Table 4-1 (below)

Degree of protection of housing to DIN 40050	Application class to DIN 40040	Required torque
IP 54/IP 50 ¹⁾	HQR	Approx. 0.3 Ncm (30 cmp)

Table 4-1 ¹⁾ On the shaft seal; seal for higher degree of protection

Ambient temperature

-25...+80 °C

Transportation and storage temperature

-40...+80 °C

Relative humidity

< 75 % annual average, occasional condensation permitted

Mechanical stress capabilities

Tested to DIN IEC 68-2-27 and 68-2-6

Impact: 50g/11 ms

Vibration: 5g/± 10 mm/5...150 Hz

EMC

Interference immunity acc. to NAMUR recommendation for industrial standard

(Surge 1.2/50 1.5 kV)

Devices with explosion protection (Ex devices) are only operated in 2-wire circuit.

Connection, housing, mounting and safety

Electrical connections

Screw terminals for 2.5 mm²
or plug connection Han 7 D (not for Ex)

Mounting orientation

any

Test voltage to IEC 1010-1

(according to DIN EN 61010-1 and DIN VDE 0411 part 1)

Material of housing

Salt-water-proof cast aluminium
Surface anodized
Plastic cover

Weight

approx. 0.5 kg

Explosion protection

Only with 2-wire connection

EC-Type-Examination Certificate

PTB 03 ATEX 2118

Type of protection

Intrinsic safety „i“

Code

II 2 G EEx ib IIC T6 or

II 2 G EEx ib IIC T4

Temperature class

T6: permissible range of ambient temperature -25 °C...+40 °C

T4: permissible range of ambient temperature -25 °C...+70 °C

Transmitter must be powered from an intrinsically safer certified current source, suitable for connection to the transmitter's power supply circuit.

In the case of a 2-wire connection, the output signal is shown as a change of the current consumption.

Mounting

Within hazardous areas of Zone 1 or Zone 2

Supply and signal current circuit

For connection to a intrinsically safe certified current circuit with the following maximum values:

$U_i = 20 \text{ V}$, $I_i = 35 \text{ mA}$, $P_i = 700 \text{ mW}$

Effective internal inductance L_i

Negligibly low

Effective internal capacitance C_i between the connections

Negligibly low

Effective internal capacitance C_i between the connections and housing (ground)

$\leq 6 \text{ nF}$

Output circuit

With type of protection „Intrinsic safety“

EEx ib IIC

The power supply circuit and output circuit are identical for the 2-wire connection. In the event of a fault, the maximum values of the power supply circuit will also occur in the output circuit.

If active, intrinsically safe circuits are connected to the output circuit, the sum total of the maximum values of the active, intrinsically safe circuits, connected to the output circuit, including the maximum values of the power supply circuit may not exceed the following values:

Voltage	to 20 V
Current	to 35 mA
Power	to 0.7 W

5 Packing instructions

If the original packing is no longer available, then the TGE 5 (-Ex) transmitter must be wrapped in an insulating airfoil or corrugated board and packed in a sufficiently large crate lined with shock absorbing material (foamed material or similar). The thickness of cushioning should be in accordance with the weight of the unit and with the method of dispatch. Mark the crate "Fragile".

For overseas shipping the instrument must additionally be sealed airtight in 0.2 mm thick polyethylene together with a dessicant (e.g. silica gel). The quantity of the dessicant should be in accordance with the packing volume and the envisaged transportation duration (at least 3 months). Furthermore, the crate should be lined with a double layer of kraft paper.

© Copyright 2006 by ABB Automation Products GmbH
We reserve the right to technical amendments

This document is protected by copyright. Information in this document is intended only to assist the user in safe and efficient operation of the equipment. Its contents are not to be reproduced in full or part without prior approval of legal owner.



ABB Automation Products GmbH

Borsigstr. 2, 63755 Alzenau, Germany

Tel. +49 551 905-534

Fax. +49 551 905-555

CCC-support.deapr@de.abb.com

We reserve the right to technical amendments.

Printed in the Fed. Rep. of Germany

42/14-33 EN Rev. 04

Edition 10.2006