

Operating Instructions

Temperaturregler

Temperature controller

1094....1097 U

1094....1097 UTA

1095 UF

1795 ...

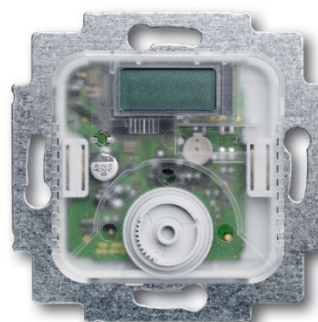

Operating Instructions

Temperaturregler

1	Safety.....	3
2	Intended use	3
3	Environment.....	3
4	Operation	4
5	Technical data.....	5
6	Setup and function.....	6
6.1	Features of function and equipment.....	6
6.2	Possible combinations	7
7	Installation and electrical connection	8
7.1	Requirements for the electrician	8
7.2	Mounting	8
7.3	Electrical connection	10
8	Commissioning	11
8.1	Calibrating the display of the actual temperature value (applies only to UTA devices).....	11
8.2	Offset function (scale correction).....	11

1 Safety



Warning

Electric voltage!

Risk of death and fire due to electrical voltage of 230 V.

- Work on the 230V supply system may only be performed by authorised electricians!
- Disconnect the mains power supply prior to installation and/or disassembly!

2 Intended use

The device is to be used exclusively with the components that are supplied and licensed as described in chapter "Setup and function".

3 Environment



Consider the protection of the environment!

Used electric and electronic devices must not be disposed of with domestic waste.

- The device contains valuable raw materials which can be recycled. Therefore, dispose of the device at the appropriate collecting depot.

All packaging materials and devices bear the markings and test seals for proper disposal. Always dispose of the packaging material and electric devices and their components via the authorized collecting depots and disposal companies.

The products meet the legal requirements, in particular the laws governing electronic and electrical devices and the REACH ordinance.

(EU Directive 2002/96/EC WEEE and 2002/95/EC RoHS)

(EU REACH ordinance and law for the implementation of the ordinance (EC) No.1907/2006)

4 Operation

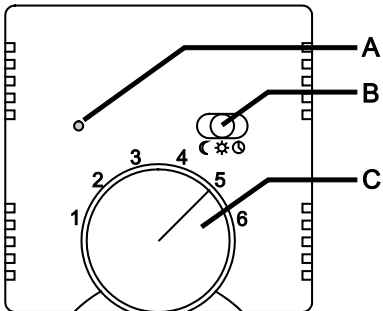

Fig. 1: Cover

Mark / Symbol	Designation / Function
A	LED - temperature reduction active
B	Slide switch
C	Control knob for selecting the desired room temperature
1	= 5°C
2	= 10°C
3	= 15°C
4	= 20°C
5	= 25°C
6	= 30°C
☰	Switch position for external temperature reduction
☀	Switch position for selected temperature
☾	Switch position for continuous temperature reduction

The temperature is continuously variable with the adjusting knob (C). The difference in temperature between two digits is approximately 5°C. For temperature adjustment and values, see the opposite columns.

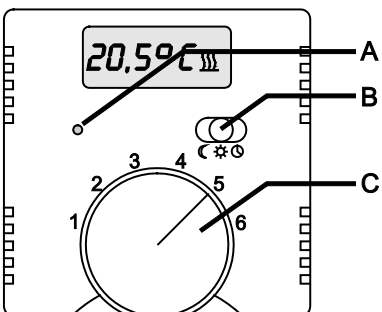

Fig. 2: Cover with cutout for display of actual temperature value (only for ... UTA)

Symbol in the display	Designation / Function
☰	Heating switched on
☾	Temperature reduction active
Calibration	Calibration

5 Technical data

General		
Nominal voltage	230 V AC \pm 10%, 50/60 Hz	1094, 1095, 1095 UF, 1097
	24 V AC \pm 10%, 50 Hz	1096
Switching capacity	10 (4) A, 230 V AC	1094, 1095
	16 A, 230 V AC	1095 U
	1 (1) A, 24 V AC	1096
	5 (2) A, 230 V AC	1097
Connection	1.5 mm ² ... 2.5 mm ²	1094, 1095, 1095, 1097
	2 x 2.5 mm ² – 1 x 4 mm ²	1095 UF
Temperature adjustment range	1 ... 6 (5 ... 30°C)	1094, 1095, 1095, 1097
	1 ... 6 (10 ... 50°C)	1095 UF
Temperature reduction	4 K	
Switching temperature difference	\pm 0.5 K	
Protection type	IP 20, EN (60529)	
Temperature sensor 1095 UF	NTC 10 k Ω / 25°C	
Maximum cable length 1095 UF	4 m	
Operating temperature range	0 ... 30 °C	





6 Setup and function





The temperature controller is used to control the temperature in closed rooms.

6.1 Features of function and equipment

Article no.	Features / Function
1094 ...	<ul style="list-style-type: none"> • Opens when the set temperature is reached. • With separate connection for time-controlled reduction of nighttime temperature (4K). • Servo valves of "closed when de-energized" design are required for the controller.
1095 ...	<ul style="list-style-type: none"> • Opens when the set temperature is reached. • With normally open contact (not applicable for 1095 UF) • With separate connection for time-controlled reduction of nighttime temperature (4K). • With installed sliding switch and control lamp for nighttime temperature reduction (4 K). • Servo valves of "closed when de-energized" design are required for the controller.
... UF	<ul style="list-style-type: none"> • With normally closed contact • With remote sensor (external temperature sensor for mounting in the floor) and thermal feedback. • For electric underfloor heating • Opening of the relay contact, when the set temperature is reached.
1096 ...	<ul style="list-style-type: none"> • Opens when the set temperature is reached. • With separate connection for time-controlled reduction of nighttime temperature (4K). • With installed sliding switch and control lamp for nighttime temperature reduction (4 K). • Servo valves of "closed when de-energized" design are required for the controller.
1097 ...	<ul style="list-style-type: none"> • With switchover contact (heating / cooling) • Servo valves of "closed when de-energized" design are required for the controller.
... UTA	<ul style="list-style-type: none"> • With display of actual temperature <ul style="list-style-type: none"> - Temperature display in steps of 0.5°C • Display accuracy: $\pm 0,5^{\circ}\text{C}$ for load currents of ≤ 2 A - Display accuracy: $\pm 1,5^{\circ}\text{C}$ for load currents of > 2 A • Automatic controller calibration

6.2 Possible combinations

	 1094 U 1097 U	 1094 UTA 1097 UTA
 1794...	X	
 1794...		X

	 1095 U / UF 1096 U	 1095 UTA 1096 UTA
 1795...	X	
 1795...		X

7 Installation and electrical connection



Warning

Electric voltage!

- Risk of death due to electrical voltage of 230 V during short-circuit in the low-voltage line.
- Low-voltage and 230 V lines must not be installed together in a flush-mounted socket!

7.1 Requirements for the electrician



Warning

Electric voltage!

Install the device only if you have the necessary electrical engineering knowledge and experience.

- Incorrect installation endangers your life and that of the user of the electrical system.
- Incorrect installation can cause serious damage to property, e.g. due to fire.

The minimum necessary expert knowledge and requirements for the installation are as follows:

- Apply the "five safety rules" (DIN VDE 0105, EN 50110):
 1. Disconnect from power;
 2. Secure against being re-connected;
 3. Ensure there is no voltage;
 4. Connect to earth and short-circuit;
 5. Cover or barricade adjacent live parts.
- Use suitable personal protective clothing.
- Use only suitable tools and measuring devices.
- Check the supply network type (TN system, IT system, TT system) to secure the following power supply conditions (classic connection to ground, protective earthing, necessary additional measures, etc.).

7.2 Mounting



Warning

Electric voltage!

Risk of death and fire due to electrical voltage of 230 V.

- Work on the 230V supply system may only be performed by authorised electricians!
- Disconnect the mains power supply prior to installation and/or disassembly!

The flush-mounted insert must only be installed in flush-mounted wall boxes according to DIN 49073-1, Part 1, or suitable surface-mounted housings.

The temperature controller is suitable for use in dry rooms only.

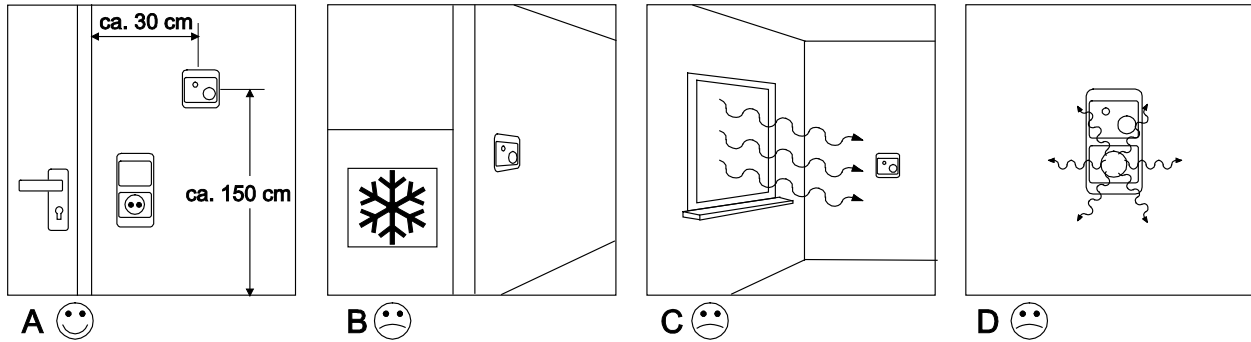

Fig. 3: Installation site

Position	Description
A	Mounting height: approx. 150 cm Minimum distance to doors or windows: approx. 30 cm
B	Avoid mounting on cold walls (thermal bridges)
C	Avoid draught and heat radiation, such as direct sunlight
D	Avoid heat radiation from adjacent devices (dimmers)

1. Connect the device according to the circuit diagram.



Note

In connection with hot-water heating, servo valves of "closed when de-energized" design are required for the controller.

2. Fix the device in the flush-mounted box according to its design.

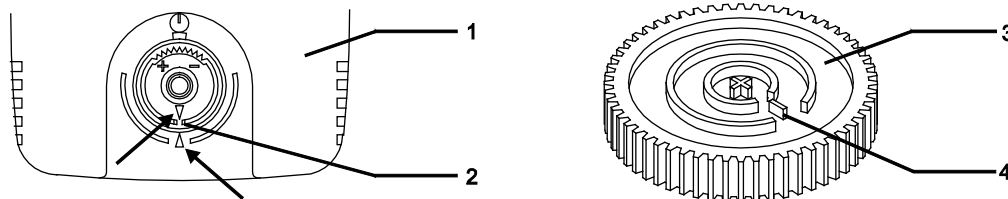

Fig. 4: Attaching the adjusting knob

1 Cover plate (cover) | 2 Drive plate | 3 Adjusting knob (rear side) | 4 Position lug

3. Seat the cover plate (1) on the insert.

4. Attach the adjusting knob (3):

- To attach the adjusting knob, turn the two arrows towards each other (basic position).
- Attach the adjusting knob vertically, so that the position lug (1) engages in the recess of the drive plate (2).

7.3 Electrical connection

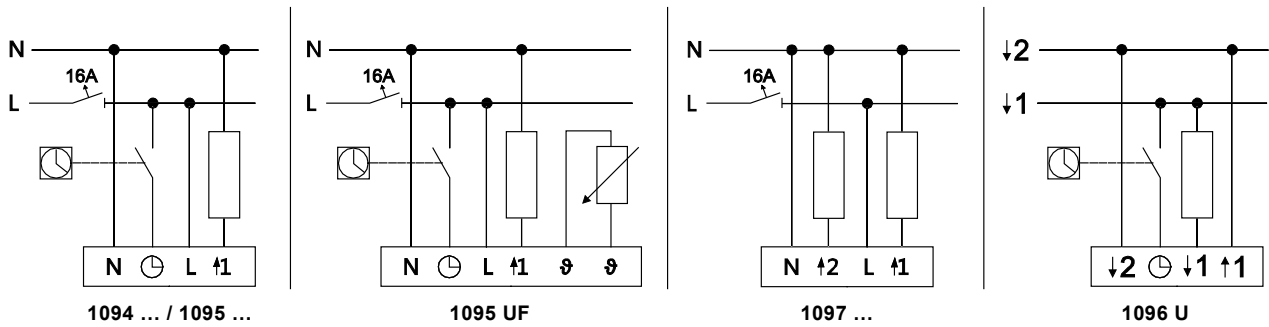

Fig. 5: Circuit diagrams

Icon	Assignment
↓1	Connections 24 V AC
↓2	Connections 24 V AC
⌚	Input for activating the temperature reduction (see nighttime reduction)
↑1	Output for controlling the heating load
↑2	Output for controlling the cooling load

8 Commissioning



Notes on commissioning

After the installation the accuracy of the switching point is established only after an operating period of 1 to 2 hours.

For faster heating and alignment of the room temperature to the setpoint temperature, it is recommended to initially set the temperature higher than required.

8.1 Calibrating the display of the actual temperature value (applies only to UTA devices)

To properly control loads larger than 2 A, the heating system must be connected for calibrating the display. After the connection, the heating system is switched on automatically for about 20 minutes. During this time, the “CA” symbol will be displayed. After this, the display adjusts itself to the room temperature within a few minutes. Before repeating the calibration procedure, the unit must be disconnected from the power supply for at least 8 minutes.

8.2 Offset function (scale correction)

Reaching the selected room temperature depends on the ambient conditions such as heating system capacity (at least 5°K/h min.), room size, ambient temperature, insulation, etc. That is why the values in the scale are merely guide values. To obtain a setting that is as accurate as possible, the adjusting knob can be offset in 4 stages by a total of $\pm 6^{\circ}\text{C}$ as follows. Compare illustration 4:

1. Pull off the adjusting knob (3).
2. Cut the position lug (1) on the bottom side of the adjusting knob off with a suitable tool.
3. Re-attach the adjusting knob, which has been offset to the basic position with the desired correcting value.

Operating Instructions

Temperaturregler

A member of the ABB Group

Busch-Jaeger Elektro GmbH

PO box
58505 Lüdenscheid

Freisenbergstraße 2
58513 Lüdenscheid
Germany

www.BUSCH-JAEGER.com

info.bje@de.abb.com

Central sales service:

Phone: +49 (0) 2351 956-1600

Fax: +49 (0) 2351 956-1700

Notice

We reserve the right to at all times make technical changes as well as changes to the contents of this document without prior notice.

The detailed specifications agreed to at the time of ordering apply to all orders. ABB accepts no responsibility for possible errors or incompleteness in this document.

We reserve all rights to this document and the topics and illustrations contained therein. The document and its contents, or extracts thereof, must not be reproduced, transmitted or reused by third parties without prior written consent by ABB.

Copyright© 2012 Busch-Jaeger Elektro GmbH
All rights reserved

1473-1-8289 | Rev. 01 | 17.12.2012