

PRODUCT BROCHURE

# eFab™ by ABB

Now there's something better than prefab.



# Introducing eFab™

From online to on-site, eFab by ABB reduces labor, inventory and shipping costs.

eFab is the powerful, comprehensive rough-in solution that allows you to design and order Steel City® prefab assemblies online and have them delivered directly to the job site for fast installation.

Choose from popular preconfigured combinations, or use our exclusive 3D eFab configurator to design your assembly just the way you want it. Either way, eFab can help ensure a quality installation every time while greatly improving your cash flow.

Steel City is the industry-leading product line of metallic switch and outlet boxes used in electrical construction. Since 1904, Steel City products have symbolized the highest quality standards in manufacturing and innovative design, with one of the most complete offerings available. Always paying attention to the details, Steel City is known for introducing small improvements that make a big difference, such as the first box offering to standardize slotted/Phillips screws on all boxes.

#### **Online.**

Easily configure the assembly in 3D or choose from our popular preassemblies.

#### **On-site.**

The order is delivered directly from the factory to the job site, fully assembled and labeled as requested.

#### **On time.**

Delivery is made when requested, so planning can be more effective.

#### **On the money.**

Installers have the finished assemblies they need, built to the same high, consistent standard and labeled for every installation point. The result? Big savings on labor, inventory, and shipping.

#### **Save steps. Save money.**

In commercial construction, labor cost is the single largest expense for an electrical contractor. It can be particularly costly to have experienced electricians assembling the thousands of components needed to route, terminate, support and protect a complicated commercial or institutional electrical system.

eFab takes care of the rough-in labor. You will save on inventory and shipping. And because your components come preassembled in the exact number you require, there is no worry about minimum order requirements on the individual parts, which often lead to leftovers.

#### **It is all about total cost reduction.**

Tap into the efficiencies of eFab and you will see significant savings in all these areas:

- Labor savings — Custom-designed assemblies of components can save you more than 50% on in-wall rough-in installation costs.
- Material savings — Special eFab ARRA and Buy-America assemblies can reduce overall material costs by up to 40%.
- Logistics savings — Deliveries of project-specific packaging and labeling direct to the job site reduce material handling and inventory costs.
- Reduced waste — Palletized eFab assemblies reduce on-site packaging and waste.
- Process improvements — eFab lets you design, quote and order your in-wall rough-in electrical systems and manage it all online.
- Extensive project support

# eFab components

## Quality you can count on.

ABB eFab assemblies are made from high-quality Steel City components. They are designed to work together in perfect harmony, whether you choose to customize your own assembly or order one of our popular standard combinations.

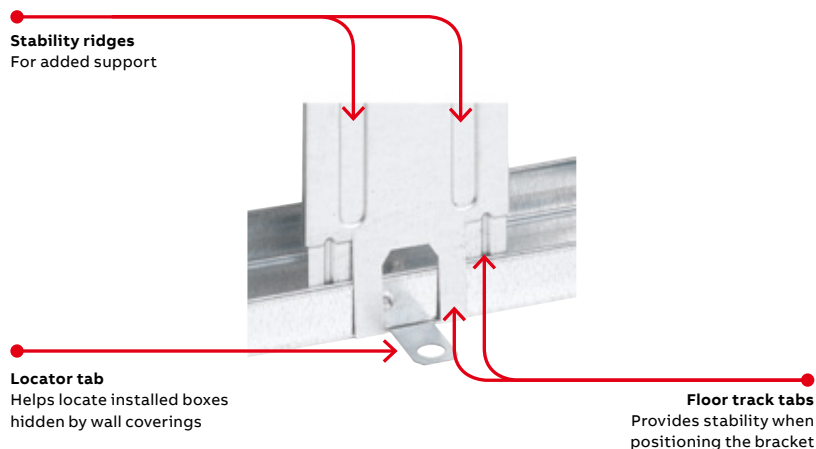
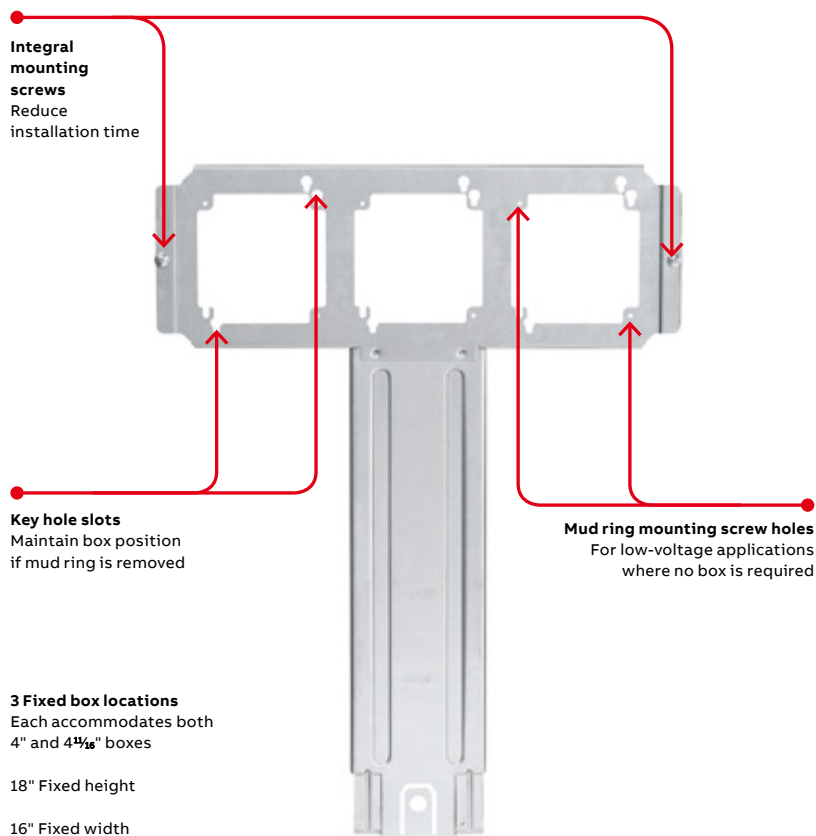

### Floor-mount T bracket

#### Consistent box locations and box height... every time

Consistency results in efficiency and labor savings on the job. With three fixed box locations and a fixed height of 18", the Steel City pre-fab T bracket provides a consistent installation every time. For added efficiency, the bracket includes integral mounting screws that help reduce installation time. A handy locator tab at the base of the bracket saves you the time of looking for installed boxes that have been hidden by wall coverings. The base also features unique floor track tabs. The inner tab slides in front of the floor track, and the two outer tabs slide behind the floor track to provide stability when positioning the bracket.

### Floor-mount T bracket

Cat. no.	Description	Std. pkg. qty.	UPC no.
H16V18S	Pre-fab T bracket	10	785991-04801

## eFab components

### Brackets



SSF-SV18

#### Extension plate bracket

- Improved bracket with bendable stabilizer leg for use on 2½" and 3½" metal studs
- Mounts outlet boxes 12" or 18" offset from either a metal stud track or a stud
- When mounted, drywall ring is brought to within ⅛" of drywall every time and will not budge or break out drywall
- Mounts 4" or 4¼" outlet boxes, 1½" or 2⅞" deep
- SV18 provides compliance with Americans with Disabilities Act (ADA) requirements

#### Extension plate bracket

Cat. no.	Description	Std. pkg. qty.
SSF-SV12	Extension plate bracket, 12" height	50
SSF-SV18	Extension plate bracket, 18" height	50



SBO16



SBO24

#### Stud-to-stud mounting brackets

- Constructed of 24-gauge steel
- Pre-measured on center for 16" (SBO16) or 24" (SBO24) stud spacing
- SBO16 accepts three 4" square or two 4¼" boxes (deep or shallow)
- SBO24 accepts five 4" square or four 4¼" boxes (deep or shallow)
- Can be mounted at any height to meet individual project requirements
- Versatile, open design enables mounting of box in any location across horizontal plane between studs
- Device cover (mud ring) mounts to front of bracket to set box in desired location
- Stamped rule on bracket with ¼", ½", and 1" markings



SBO24 mounted to 24" studs with one 4" square box installed



SBO24 mounted to 24" studs with five 4" square boxes (full capacity) installed

#### Stud-to-stud mounting brackets

Cat. no.	Description	Std. pkg. qty.	UPC no.
SBO16	16" Stud-to-stud horizontal mounting bracket	25	785991-03893
SBO24	24" Stud-to-stud horizontal mounting bracket	25	785991-03895

## eFab components

### Mounting brackets

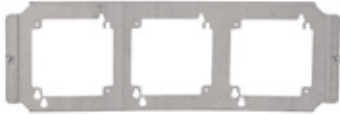

H16S

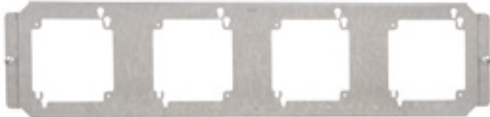

H24S

#### Stud-to-stud mounting brackets — Fixed box position

- Supports electrical boxes, plaster rings or low-voltage devices from one bracket
- Accommodates 4" or 4<sup>1</sup>/<sub>16</sub>" boxes
- Bendable leg serves as a bracket stabilizer
- SB brackets allow box mounting in all four 90° orientations

#### Stud-to-stud mounting brackets — Fixed box position

Cat. no.	Description	Std. pkg qty.
H16S	Box mounting bracket for between studs, 16" stud spacing	25
H24S	Box mounting bracket for between studs, 24" stud spacing	25

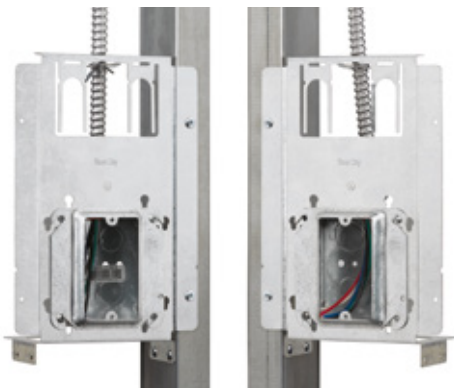

Can be mounted either left or right of the stud

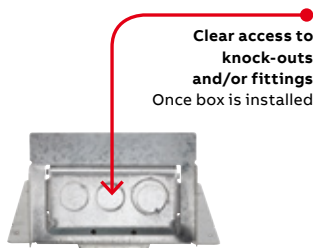

Bottom view of bracket with box installed

#### Box-to-stud mounting bracket with far-side and cable support

##### Three products in one.

The savings can add up, particularly on a large job, when a box bracket, far-side support and cable support are combined in one product to reduce your labor and inventory costs. It is designed for maximum flexibility with flanges for either left or right stud mount, and compatibility with both 4" and 4<sup>1</sup>/<sub>16</sub>" boxes.

- Built-in cable support secures cable 6" above the box, satisfying NEC code requirements
- Flexible design accommodates both 4" and 4<sup>1</sup>/<sub>16</sub>" boxes
- Key-hole box mounting slots maintain box position if mud ring needs to be removed
- Provides clear access to knockouts once the box is installed for installation of fittings
- Mounts to either side of the stud

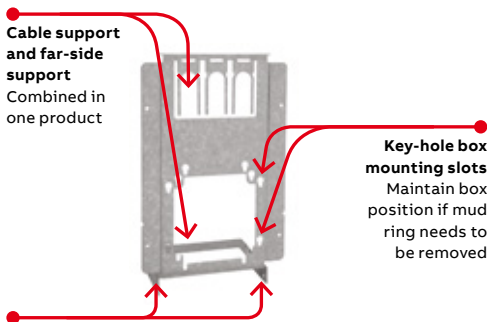

**Cable support and far-side support**  
Combined in one product

**Key-hole box mounting slots**  
Maintain box position if mud ring needs to be removed

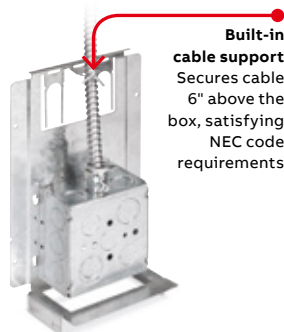

**Built-in cable support**  
Secures cable 6" above the box, satisfying NEC code requirements

Back view of bracket with box, fitting and cable installed

#### Box-to-stud mounting bracket with far-side and cable support

Cat. no.	Description	Std. pkg qty.
SSF-SH2346-CS	Pre-fab box bracket with far-side and cable support	50

**eFab components**

Box-to-stud mounting bracket

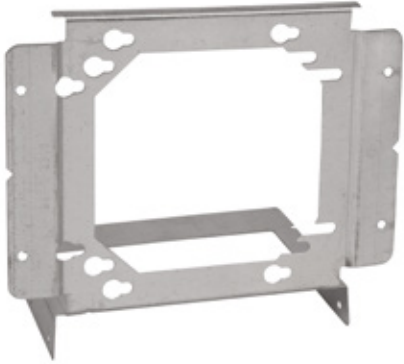

SSF-SH2346

**Box-to-stud mounting bracket**

- Attaches 4" and 4<sup>11</sup>/<sub>16</sub>" electrical boxes to metal stud
- Support leg can be attached to stud to eliminate movement of box in wall
- Attaches to metal or wood stud using self-tapping screws and screw gun or nails
- One part mounts boxes for 1½", 2½", 3½", 4" and 6" studs, reducing inventory

**Box-to-stud mounting bracket**

Cat. no.	Description	Std. pkg. qty.	UPC no.
SSF-SH2346	Bracket for mounting 4" or 4 <sup>11</sup> / <sub>16</sub> " box to 1½", 2½", 3½", 4" or 6" stud	100	785991-20731

**Diagrams**

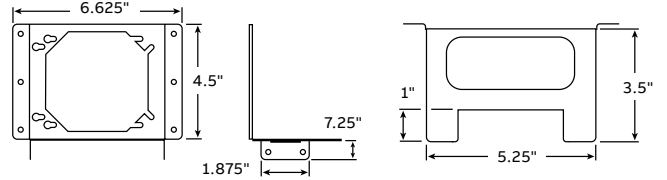

## eFab components

### Mounting brackets

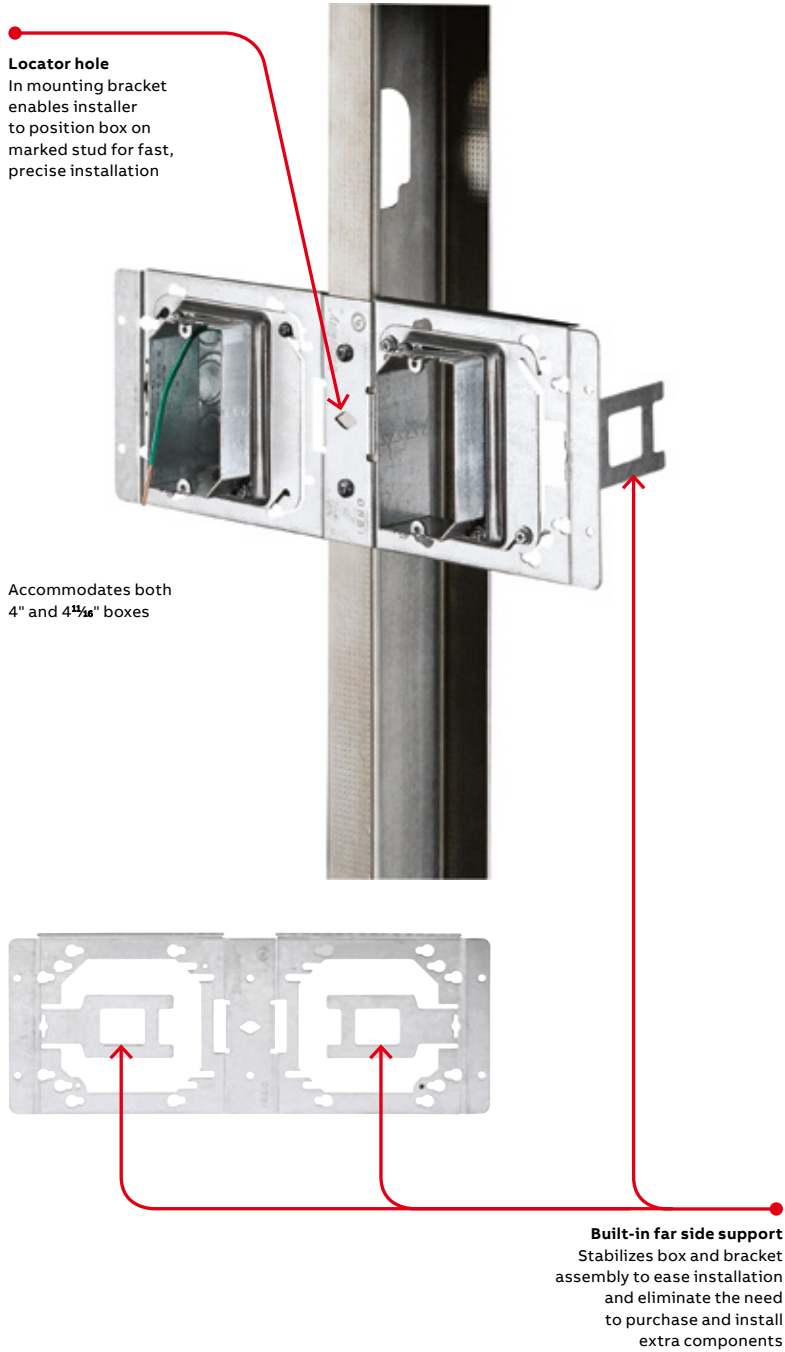

#### Dual box-to-stud mounting bracket

One component replaces two, reducing both material and labor costs.



Power on both sides of the stud



Low voltage on both sides of the stud

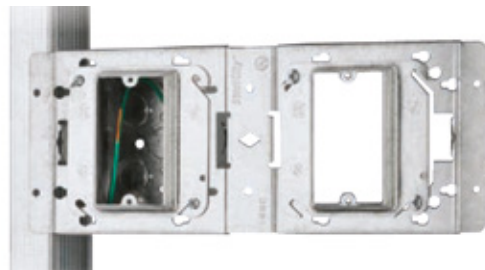

Power and low voltage on the same side of the stud

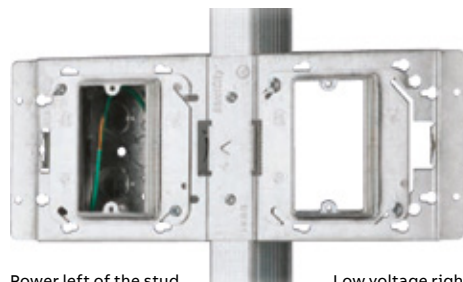

Power left of the stud

Low voltage right of the stud

#### Dual box-to-stud mounting bracket

Cat. no.	Description	Std. pkg. qty.	UPC no.
DBB1	Pre-fab dual box bracket	50	785991-04625



## eFab components

### Covers and brackets

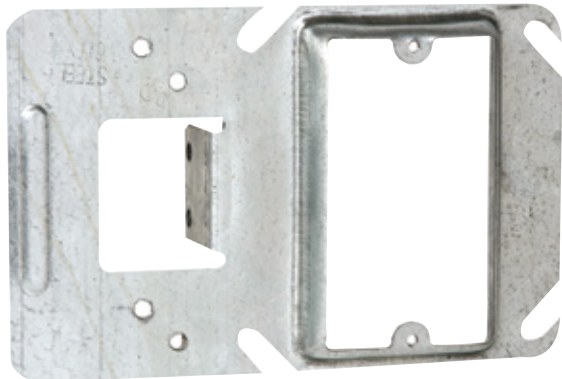

52CM14-5/8

#### Box support covers

- Combines a box-to-stud mounting bracket with a device cover in one easy-to-use product
- Designed for use with 4" square boxes
- Used with both steel and wood studs
- Cover raised  $\frac{1}{2}$ ",  $\frac{5}{8}$ " or  $\frac{3}{4}$ "
- Designed for one or two devices

#### Box support covers



Cat. no.	Raised (in.)	No. of devices	Cu. in. cap.	Std. pkg. qty.	UPC no.
52CM13	$\frac{1}{2}$	1	3.0	25	785991-02634
52CM14-5/8	$\frac{5}{8}$	1	4.0	25	785991-02635
52CM14	$\frac{3}{4}$	1	5.0	25	785991-02636
52CMD17	$\frac{1}{2}$	2	6.3	25	785991-02637
52CMD18-5/8	$\frac{5}{8}$	2	7.3	25	785991-02638
52CMD18	$\frac{3}{4}$	2	9.0	25	785991-02639



SSF-SG16A

#### Adjustable box brackets

- Designed for metal studs 16" or 24" on center
- Can also be adjusted for non-standard stud spacing
- Adjustable tabs accommodate  $1\frac{1}{2}$ " or  $2\frac{1}{8}$ " box depths
- Enables mounting of multiple boxes
- Installs easily — dimples provide a starting point for screws

#### Adjustable box brackets



Cat. no.	Description	Studs pacing (in.)	Box depth (in.)	Std. pkg. qty.	UPC no.
SSF-SG16A	16" Adjustable box bracket	11–18	$1\frac{1}{2}$ or $2\frac{1}{8}$	50	785991-01489
SSF-SG24A	24" Adjustable box bracket	17–26	$1\frac{1}{2}$ or $2\frac{1}{8}$	50	785991-01490



## eFab components

### Adjustable mud rings



#### Adjustable mud rings

Available in both single- and two-gang.

UL-listed mud rings feature an inner ring that adjusts from ½" to 1½" in depth to accommodate various drywall thicknesses. Marked with a measured rule and equipped with two adjustment screws, the inner ring can be set to the anticipated depth prior to installation and then easily adjusted after drywall installation to accommodate any variation in depth (½" to 1½").



Wedge locking blocks  
Designed to ensure grounding continuity

#### Adjustable mud ring installation/adjustment steps:

- 01 Loosen... The two adjustment screws located on opposing corners of the mud ring.
- 02 Adjust... Inner ring to be flush with wall surface.
- 03 Re-tighten... Adjustment screws.



01



02



03

#### Adjustable mud rings

Cat. no.	Description	Std. pkg. qty.
52-C-ADJ	Single-gang adjustable mud ring, ½" to 1½"	25
52-C-ADJ2	Two-gang adjustable mud ring, ½" to 1½"	20

## eFab components

### Brackets and conduit support



CSB1



#### Cable support bracket

Meets code requirements for supporting and securing installed MC cable.

- Provides a simple means of complying with NEC 330.30 requirements for securing and supporting MC cable
- Quick and easy locking tab snaps through slot to secure cable
- Ribs maintain separation of cables
- Durable steel construction retains integrity
- Versatile design—use with Romex or MC cable
- UL listed

#### Cable support bracket



Cat. no.	Description	Std. pkg. qty.
CSB1	Cable support bracket	100



Fig. 1

#### Screwed-on conduit support

- Supports 1/2" and 3/4" EMT conduit and MC/AC cable
- Works with wood or metal stud
- Preset bend provides alignment with knockouts for 1 1/2"-deep boxes or 2 1/8"-deep boxes

#### Screwed-on conduit support

Cat. no.	Fig. no.	Description	Std. pkg. qty.
SSF-SS1/2 3/4	1	1/2" and 3/4" EMT conduit and MC/AC to metal or wood stud. For 1 1/2" deep box.	100
SSF-SS1/2 3/4D	-	1/2" and 3/4" EMT conduit and MC/AC to metal or wood stud. For 2 1/8" deep box.	100

Diagram

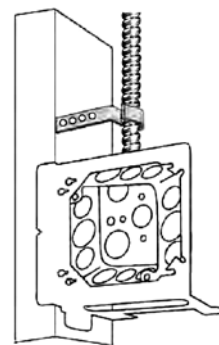

## eFab components

### Steel City super deep 4" square wall boxes



521911234



521911234RD



521911234CV



521911234CVRD

#### Steel City super deep 4" square wall boxes

- Increased capacity accommodates large devices in commercial and industrial applications, such as fire alarm systems
- Red-painted version available for quick and easy identification of life-safety electrical systems
- Available with or without integrally mounted support bracket

#### Super deep 4" square wall boxes

Cat. no.	Description	Brkts.	Each side KO	Each end KO	Bottom KO	Cu. inch capacity	Std. pkg. qty.
521911234RD	3½"-Deep, 4"-square red box	-	(4) ½" & ¾" combo	(2) ½" & ¾" combo	(4) ½" & ¾" combo	46	24
521911234CVRD	3½"-Deep, 4"-square red box with side mounting bracket	CV	(4) ½" & ¾" combo	(2) ½" & ¾" combo	(4) ½" & ¾" combo	46	10
521911234	3½"-Deep, 4"-square box	-	(4) ½" & ¾" combo	(2) ½" & ¾" combo	(4) ½" & ¾" combo	46	24
521911234CV	3½"-Deep, 4"-square box with side mounting bracket	CV	(4) ½" & ¾" combo	(2) ½" & ¾" combo	(4) ½" & ¾" combo	46	10

## eFab components

### Fire alarm boxes and fittings



52171-1234RD



72171-1234RD



52171-EXTRD



52-C-1RD



52151-1234RD



52171-CV-1234RD



52171-EXTOWRD



53171-1234RD

#### Fire alarm boxes and fittings

##### Easy to identify and install.

Steel City fire alarm boxes and fittings can meet all of your visual identification requirements for fire alarm systems — and make installation and upgrades faster and easier than ever before.

Available in a variety of sizes to accommodate new or old work configurations, these boxes are simple to install with high-quality ABB fittings. Plus the bright red finish eliminates time-consuming painting of existing fixtures and provides long-lasting identification in even the harshest environments.

#### Fire alarm boxes



Cat. no.	Description	Ears	Brkts.	Each side KO	Each end KO	Bottom KO	Cu. inch capacity	Std. pkg. qty.
52171-1234RD	2½"-deep 4-square red box	-	-	2½", 1½" & ¾"E	2½", 1½" & ¾"E	3½", 2½" & ¾"E	30.3	50
52151-1234RD	1½"-deep drawn red box	-	-	2½", 1¾"	2½", 1¾"	3½", 2¾"	21.0	50
72171-1234RD	2½"-deep 41¼" red box	-	-	3½" & ¾"E	3½" & ¾"E	3½", 2½" & ¾"E	42.0	20
52171-CV-1234RD	2½"-deep 4-square red box with CV bracket	-	CV	2½", 1½" & ¾"E	2½", 1½" & ¾"E	3½", 2½" & ¾"E	30.3	50
52171-EXTRD	2½"-deep 4-square red box with ext. ring	-	-	4½", 2½" & ¾"E	4½", 2½" & ¾"E	3½", 2½" & ¾"E	60.6	25
52171-EXTOWRD	2½"-deep 4-square red box with ext. ring and old work ears	Yes	-	4½", 2½" & ¾"E	4½", 2½" & ¾"E	3½", 2½" & ¾"E	60.6	25
52-C-1RD	Flat 4-square red cover	-	-	-	-	-	-	100
53171-1234RD	2½"-deep 4-square red extension ring	-	-	2½", 1½" & ¾"E	2½", 1½" & ¾"E	-	30.3	25



TK122A-FA



TK121A-FA



TC122A-FA



TC121A-FA

#### Fire alarm fittings



Cat. no.	Description	Std. pkg. qty.
TC121A-FA	½" Red steel EMT set screw connector	50
TC122A-FA	¾" Red steel EMT set screw connector	50
TC123A-FA	1" Red steel EMT set screw connector	25
TC721A-FA	½" Red insulated steel EMT set screw connector	50
TC722A-FA	¾" Red insulated steel EMT set screw connector	50
TC723A-FA	1" Red insulated steel EMT set screw connector	25
TK121A-FA	½" Red steel EMT set screw coupling	50
TK122A-FA	¾" Red steel EMT set screw coupling	50
TK123A-FA	1" Red steel EMT set screw coupling	25

# eFab typical assemblies

## How successful projects are put together

Here are some of our most requested preassembled units. Order as is or customize further using the eFab configurator.



151-SV18-1458



151-SV12-1458

### Box with pre-installed 10½" pigtail, raised cover and vertical mounting bracket

- 4" square welded box, 1½" or 2⅝" deep
- Pre-installed 10½" insulated grounding pigtail
- One- or two-device cover, raised ½", ⅝" or ¾"
- 12" (SSF-SV12) or 18" (SSF-SV18) vertical mounting bracket
- Save on labor costs by eliminating multiple installation steps

### Box with pre-installed 10½" pigtail, raised cover and vertical mounting bracket



Cat. no.	Box type included	Box depth (in.)	Pigtail included (in.)	Box cover included	Raised (in.)	No. of devices	Bracket included	Std. pkg. qty.	UPC no.
151-SV12-13	521511234EW	1½	10½	52-C-13	½	1	SSF-SV12	10	785991-02601
151-SV12-1458	521511234EW	1½	10½	52-C-14-5/8	⅝	1	SSF-SV12	10	785991-02602
151-SV12-14	521511234EW	1½	10½	52-C-14	¾	1	SSF-SV12	10	785991-02752
151-SV12-17	521511234EW	1½	10½	52-C-17-25	½	2	SSF-SV12	10	785991-02754
151-SV12-1858	521511234EW	1½	10½	52-C-18-5/8-25	⅝	2	SSF-SV12	10	785991-02756
151-SV12-18	521511234EW	1½	10½	52-C-18	¾	2	SSF-SV12	10	785991-02604
171-SV12-13	521711234E	2⅝	10½	52-C-13	½	1	SSF-SV12	10	785991-02589
171-SV12-1458	521711234E	2⅝	10½	52-C-14-5/8	⅝	1	SSF-SV12	10	785991-02591
171-SV12-14	521711234E	2⅝	10½	52-C-14	¾	1	SSF-SV12	10	785991-02590
171-SV12-17	521711234E	2⅝	10½	52-C-17-25	½	2	SSF-SV12	10	785991-02770
171-SV12-1858	521711234E	2⅝	10½	52-C-18-5/8-25	⅝	2	SSF-SV12	10	785991-02774
171-SV12-18	521711234E	2⅝	10½	52-C-18	¾	2	SSF-SV12	10	785991-02772
151-SV18-13	521511234EW	1½	10½	52-C-13	½	1	SSF-SV18	10	785991-02606
151-SV18-1458	521511234EW	1½	10½	52-C-14-5/8	⅝	1	SSF-SV18	10	785991-02607
151-SV18-14	521511234EW	1½	10½	52-C-14	¾	1	SSF-SV18	10	785991-02758
151-SV18-17	521511234EW	1½	10½	52-C-17-25	½	2	SSF-SV18	10	785991-02760
151-SV18-1858	521511234EW	1½	10½	52-C-18-5/8-25	⅝	2	SSF-SV18	10	785991-02762
151-SV18-18	521511234EW	1½	10½	52-C-18	¾	2	SSF-SV18	10	785991-02609
171-SV18-13	521711234E	2⅝	10½	52-C-13	½	1	SSF-SV18	10	785991-02593
171-SV18-1458	521711234E	2⅝	10½	52-C-14-5/8	⅝	1	SSF-SV18	10	785991-02595
171-SV18-14	521711234E	2⅝	10½	52-C-14	¾	1	SSF-SV18	10	785991-02594
171-SV18-17	521711234E	2⅝	10½	52-C-17-25	½	2	SSF-SV18	10	785991-02776
171-SV18-1858	521711234E	2⅝	10½	52-C-18-5/8-25	⅝	2	SSF-SV18	10	785991-02780
171-SV18-18	521711234E	2⅝	10½	52-C-18	¾	2	SSF-SV18	10	785991-02778

## eFab typical assemblies

### Box-to-stud mounting bracket with far-side and cable support

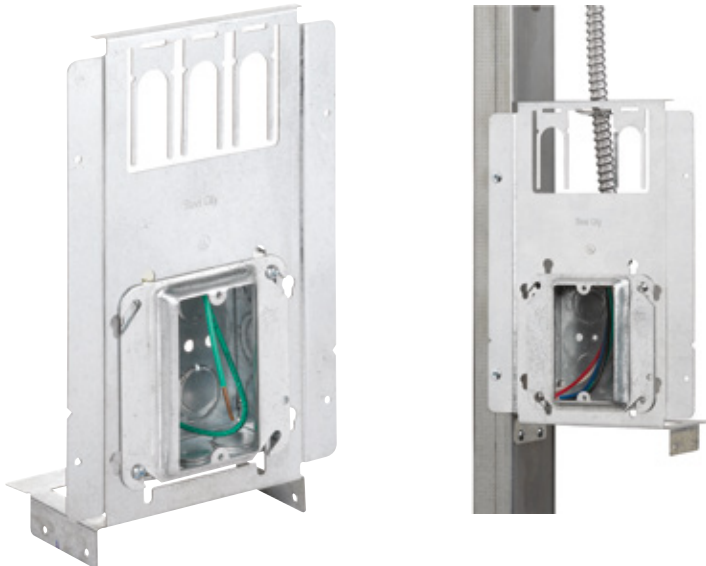

SSF-SH2346-CS

#### Box-to-stud mounting bracket with far-side and cable support

- Built-in cable support secures cable 6" above the box, satisfying NEC code requirements
- Flexible design accommodates both 4" and 4<sup>11</sup>/<sub>16</sub>" boxes
- Key-hole box mounting slots maintain box position if mud ring needs to be removed
- Pre-installed 10<sup>1</sup>/<sub>2</sub>" insulated grounding pigtail
- One- or two-device cover, raised 1/2", 5/8" or 3/4"
- Save on labor costs by eliminating multiple installation steps

#### Box-to-stud mounting bracket with far-side and cable support



Cat. no.	Box type included	Box depth (in.)	Pigtail included (in.)	Box cover included	Raised (in.)	No. of devices	Bracket included	Std. pkg. qty.	UPC no.
151-SH2346-13-CS	521511234EW	1½	10½	52-C-13	½	1	SSF-SH2346-CS	10	785991-07178
151-SH2346-1458-CS	521511234EW	1½	10½	52-C-14-5/8	5/8	1	SSF-SH2346-CS	10	785991-07179
151-SH2346-14-CS	521511234EW	1½	10½	52-C-14	¾	1	SSF-SH2346-CS	10	785991-07180
151-SH2346-17-CS	521511234EW	1½	10½	52-C-17-25	½	2	SSF-SH2346-CS	10	785991-07181
151-SH2346-1858-CS	521511234EW	1½	10½	52-C-18-5/8-25	5/8	2	SSF-SH2346-CS	10	785991-07182
151-SH2346-18-CS	521511234EW	1½	10½	52-C-18	¾	2	SSF-SH2346-CS	10	785991-07183
171-SH2346-13-CS	521711234E	2½	10½	52-C-13	½	1	SSF-SH2346-CS	10	785991-07184
171-SH2346-1458-CS	521711234E	2½	10½	52-C-14-5/8	5/8	1	SSF-SH2346-CS	10	785991-07186
171-SH2346-14-CS	521711234E	2½	10½	52-C-14	¾	1	SSF-SH2346-CS	10	785991-07187
171-SH2346-17-CS	521711234E	2½	10½	52-C-17-25	½	2	SSF-SH2346-CS	10	785991-07188
171-SH2346-1858-CS	521711234E	2½	10½	52-C-18-5/8-25	5/8	2	SSF-SH2346-CS	10	785991-07189
171-SH2346-18-CS	521711234E	2½	10½	52-C-18	¾	2	SSF-SH2346-CS	10	785991-07191

## eFab typical assemblies

Box with pre-installed 10½" pigtail, raised cover and box-to-stud bracket



151-SH2346-13



171-SH2346-1458

### Box with pre-installed 10½" pigtail, raised cover and box-to-stud bracket

- 4" square welded box, 1½" or 2½" deep
- Pre-installed 10½" insulated grounding pigtail
- One- or two-device cover, raised ½", ⅝" or ¾"
- SSF-SH2346 box-to-stud mounting bracket
- Save on labor costs by eliminating multiple installation steps

### Box with pre-installed 10½" pigtail, raised cover and box-to-stud bracket



Cat. no.	Box type included	Box depth (in.)	Box included (in.)	Pigtail included (in.)	Box cover included	Raised (in.)	No. of devices	Bracket included	Std. pkg. qty.	UPC no.
151-SH2346-13*	521511234EW	1½	1½	10½	52-C-13	½	1	SSF-SH2346	10	785991-02611
151-SH2346-1458 *	521511234EW	1½	1½	10½	52-C-14-5/8	⅝	1	SSF-SH2346	10	785991-02612
151-SH2346-14 *	521511234EW	1½	1½	10½	52-C-14	¾	1	SSF-SH2346	10	785991-02746
151-SH2346-17 *	521511234EW	1½	1½	10½	52-C-17-25	½	2	SSF-SH2346	10	785991-02748
151-SH2346-1858 *	521511234EW	1½	1½	10½	52-C-18-5/8-25	⅝	2	SSF-SH2346	10	785991-02810
151-SH2346-18 *	521511234EW	1½	1½	10½	52-C-18	¾	2	SSF-SH2346	10	785991-02614
171-SH2346-13	521711234E	2½	2½	10½	52-C-13	½	1	SSF-SH2346	10	85991-02597
171-SH2346-1458	521711234E	2½	2½	10½	52-C-14-5/8	⅝	1	SSF-SH2346	10	785991-02599
171-SH2346-14	521711234E	2½	2½	10½	52-C-14	¾	1	SSF-SH2346	10	785991-02598
171-SH2346-17	521711234E	2½	2½	10½	52-C-17-25	½	2	SSF-SH2346	10	785991-02764
171-SH2346-1858	521711234E	2½	2½	10½	52-C-18-5/8-25	⅝	2	SSF-SH2346	10	785991-02812
171-SH2346-18	521711234E	2½	2½	10½	52-C-18	¾	2	SSF-SH2346	10	785991-02766

\* ¾" KO not usable in shallow box.

## eFab typical assemblies

Box with pre-installed 10½" pigtail and box support cover

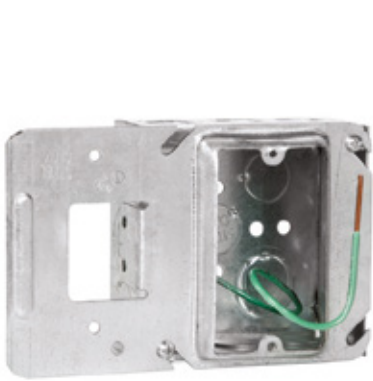

52171-CM14-5/8

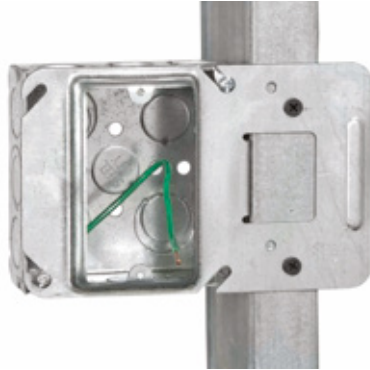

52171-CM14-5/8 mounted to stud

### Box with pre-installed 10½" pigtail and box support cover

- 4" square welded box, 1½" or 2⅝" deep
- Pre-installed 10½" insulated grounding pigtail
- Box support cover combines box-to-stud mounting bracket with device cover
- One- or two-device box support cover, raised ½", ⅝" or ¾"
- Save on labor costs by eliminating multiple installation steps

### Box with pre-installed 10½" pigtail and box support cover



Cat. no.	Box type included	Box depth (in.)	Pigtail included (in.)	Box cover included	Raised (in.)	No. of devices	Std. pkg. qty.	UPC no.
52151-CM13	521511234EW	1½	10½	52CM13	½	1	25	785991-02712
52151-CM14-5/8	521511234EW	1½	10½	52CM14-5/8	⅝	1	25	785991-02714
52151-CM14	521511234EW	1½	10½	52CM14	¾	1	25	785991-02716
52151-CMD17	521511234EW	1½	10½	52CMD17	½	2	25	785991-02718
52151-CMD18-5/8	521511234EW	1½	10½	52CMD18-5/8	⅝	2	25	785991-02720
52151-CMD18	521511234EW	1½	10½	52CMD18	¾	2	25	785991-02722
52171-CM13	521711234E	2⅝	10½	52CM13	½	1	25	785991-02700
52171-CM14-5/8	521711234E	2⅝	10½	52CM14-5/8	⅝	1	25	785991-02702
52171-CM14	521711234E	2⅝	10½	52CM14	¾	1	25	785991-02704
52171-CMD17	521711234E	2⅝	10½	52CMD17	½	2	25	785991-02706
52171-CMD18-5/8	521711234E	2⅝	10½	52CMD18-5/8	⅝	2	25	785991-02708
52171-CMD18	521711234E	2⅝	10½	52CMD18	¾	2	25	785991-02710



## eFab typical assemblies

### MS series pre-assemblies

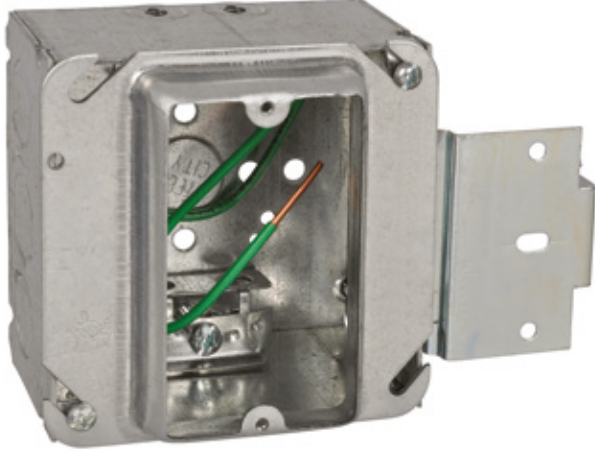

171-MSX-14

#### MS series pre-assemblies

- 4" square and 4<sup>11</sup>/<sub>16</sub>" square boxes
- 1<sup>1</sup>/<sub>2</sub>" deep or 2<sup>1</sup>/<sub>8</sub>" deep
- Pre-installed 10<sup>1</sup>/<sub>2</sub>" insulated grounding pigtail
- Available with conduit KOs or clamps for flexible/armored/MC cable
- Save on labor costs by eliminating multiple installation steps

#### MS series pre-assemblies



Cat. No.	Box type included	Box depth (in.)	Pigtail included (in.)	Box cover included	Raised (in.)	No. of devices	Std. pkg. qty.
151-MS-13	52151-MS-1/2 3/4	1 <sup>1</sup> / <sub>2</sub>	10 <sup>1</sup> / <sub>2</sub>	52-C-13	<sup>1</sup> / <sub>2</sub>	1	25
151-MS-14	52151-MS-1/2 3/4	1 <sup>1</sup> / <sub>2</sub>	10 <sup>1</sup> / <sub>2</sub>	52-C-14	<sup>3</sup> / <sub>4</sub>	1	25
151-MS-1458	52151-MS-1/2 3/4	1 <sup>1</sup> / <sub>2</sub>	10 <sup>1</sup> / <sub>2</sub>	52-C-14-5/8	<sup>5</sup> / <sub>8</sub>	1	25
171MS13	52171-MS-1/2 3/4	2 <sup>1</sup> / <sub>8</sub>	10 <sup>1</sup> / <sub>2</sub>	52-C-13	<sup>1</sup> / <sub>2</sub>	1	25
171-MS-14	52171-MS-1/2 3/4	2 <sup>1</sup> / <sub>8</sub>	10 <sup>1</sup> / <sub>2</sub>	52-C-14	<sup>3</sup> / <sub>4</sub>	1	25
171-MS-1458	52171-MS-1/2 3/4	2 <sup>1</sup> / <sub>8</sub>	10 <sup>1</sup> / <sub>2</sub>	52-C-14-5/8	<sup>5</sup> / <sub>8</sub>	1	25
171MS18	52171-MS-1/2 3/4	2 <sup>1</sup> / <sub>8</sub>	10 <sup>1</sup> / <sub>2</sub>	52-C-18	<sup>3</sup> / <sub>4</sub>	2	25
171-MS-18 5/8	52171-MS-1/2 3/4	2 <sup>1</sup> / <sub>8</sub>	10 <sup>1</sup> / <sub>2</sub>	52-C-18-5/8-25	<sup>5</sup> / <sub>8</sub>	2	25
171MSX13	52171-MSX	2 <sup>1</sup> / <sub>8</sub>	10 <sup>1</sup> / <sub>2</sub>	52-C-13	<sup>1</sup> / <sub>2</sub>	1	25
171-MSX-14	52171-MSX	2 <sup>1</sup> / <sub>8</sub>	10 <sup>1</sup> / <sub>2</sub>	52-C-14	<sup>3</sup> / <sub>4</sub>	1	25
171-MSX-1458	52171-MSX	2 <sup>1</sup> / <sub>8</sub>	10 <sup>1</sup> / <sub>2</sub>	52-C-14-5/8	<sup>5</sup> / <sub>8</sub>	1	25
171MSX18	52171-MSX	2 <sup>1</sup> / <sub>8</sub>	10 <sup>1</sup> / <sub>2</sub>	52-C-18	<sup>3</sup> / <sub>4</sub>	2	25
171-MSX-18 5/8	52171-MSX	2 <sup>1</sup> / <sub>8</sub>	10 <sup>1</sup> / <sub>2</sub>	52-C-18-5/8-25	<sup>5</sup> / <sub>8</sub>	2	25
72171MS14	72171-MS-1/2 3/4	2 <sup>1</sup> / <sub>8</sub>	10 <sup>1</sup> / <sub>2</sub>	72-C-14	<sup>3</sup> / <sub>4</sub>	1	25
72171-MS-1458	72171-MS-1/2 3/4	2 <sup>1</sup> / <sub>8</sub>	10 <sup>1</sup> / <sub>2</sub>	72-C-14-5/8	<sup>5</sup> / <sub>8</sub>	1	25
72171MS18	72171-MS-1/2 3/4	2 <sup>1</sup> / <sub>8</sub>	10 <sup>1</sup> / <sub>2</sub>	72-C-18	<sup>3</sup> / <sub>4</sub>	2	25
72171-MS-18 5/8	72171-MS-1/2 3/4	2 <sup>1</sup> / <sub>8</sub>	10 <sup>1</sup> / <sub>2</sub>	72-C-18-5/8	<sup>5</sup> / <sub>8</sub>	2	25
72171MSX14	72171-MS-1/2 3/4	2 <sup>1</sup> / <sub>8</sub>	10 <sup>1</sup> / <sub>2</sub>	72-C-14	<sup>3</sup> / <sub>4</sub>	1	25
72171-MSX-1458	72171-MSX	2 <sup>1</sup> / <sub>8</sub>	10 <sup>1</sup> / <sub>2</sub>	72-C-14-5/8	<sup>5</sup> / <sub>8</sub>	1	25
72171MSX18	72171-MS-1/2 3/4	2 <sup>1</sup> / <sub>8</sub>	10 <sup>1</sup> / <sub>2</sub>	72-C-18	<sup>3</sup> / <sub>4</sub>	2	25
72171-MSX-1858	72171-MS-1/2 3/4	2 <sup>1</sup> / <sub>8</sub>	10 <sup>1</sup> / <sub>2</sub>	72-C-18-5/8	<sup>5</sup> / <sub>8</sub>	2	25

## eFab typical assemblies

### Box with pre-installed 10½" pigtail

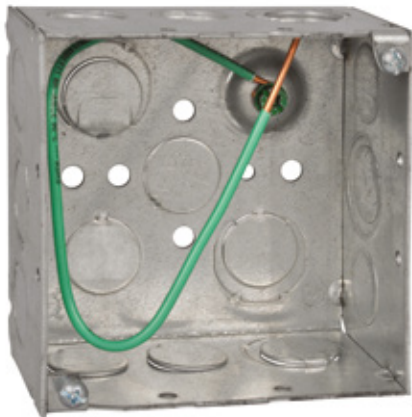

521711234EP

#### Box with pre-installed 10½" pigtail

- Popular 4" square boxes and switch boxes
- Pre-installed 10½" insulated grounding pigtail
- Save on labor costs by eliminating multiple installation steps

#### Box with pre-installed 10½" pigtail



Cat. No.	Box type included	Knockouts	Pre-installed pigtail (in.)	Std. pkg. qty.	UPC no.
521511234EWP	52151234EW 4"-sq. x 1½"D welded box	Eccentric	10½	50	785991-02588
521511234P	521511234 4"-sq. x 1½"D drawn box	½" & ¾"	10½	50	785991-02586
521711234EP	521711234E 4"-sq. x 2½"D welded box	½" & ¾" Eccentric	10½	50	785991-02587
52151XP	52151X 4"-sq. x 1½"D welded box	½" & ¾" Eccentric	10½	50	785991-02724
52151CVNP	52151CVN 4"-sq. x 1½"D welded box	½" & ¾" Eccentric	10½	25	785991-02728
LXWOWP	LXWOW-25 3"H x 2"W x 2½"D gangable switch box	½"	10½	25	785991-02959
LXVP	LXV-25 3"H x 2"W x 2½"D gangable switch box	½"	10½	25	785991-02692
CXWOWP	CXWOW 3"H x 2"W x 3½"D gangable switch box	½" & ¾"	10½	25	785991-02694
CXWVP	CXWV 3"H x 2"W x 3½"D gangable switch box	½" & ¾"	10½	25	785991-02696
CXP	CX 3"H x 2"W x 3½"D gangable switch box	½" & ¾"	10½	25	785991-02698



---

**ABB Inc.**

Electrification Products  
860 Ridge Lake Blvd.  
Memphis, TN 38120  
Customer Service: 800-816-7809  
Technical Support: 888-862-3289

**[abb.com/lowvoltage](http://abb.com/lowvoltage)**