

OVRHSP-160

Facility Wide Protection – 1,000A and below



Product features

- UL Listed 1449 4th edition for Type 1 and Type 2 SPD applications.
- Fail-safe design with individually fused Metal Oxide Varistors (MOVs) eliminating single point failure, protecting against both overcurrent and overvoltage events.
- 200kAIC short circuit rating permits direct bus connection to most electrical services.
- Low let through voltage ensured by the lowest possible impedance path to ground and equal current sharing during surge events.
- All weather sealed, powder-coated NEMA 4/IP65 housing is designed for any orientation and indoor/outdoor applications.
- 10-year standard warranty.

Available configurations

Model number	Voltage	Configuration
OVRHSP1601201P	120V	1-phase, 2-wire + ground
OVRHSP1602401P	240V	1-phase, 2-wire + ground
OVRHSP1601202S	120/240V	2-phase, 3-wire + ground
OVRHSP1601203Y	120/208V	3-phase Wye, 4-wire + ground
OVRHSP1602203Y	220/380V	3-phase Wye, 4-wire + ground
OVRHSP1602403Y	240/415V	3-phase Wye, 4-wire + ground
OVRHSP1602773Y	277/480V	3-phase Wye, 4-wire + ground
OVRHSP1603473Y	347/600	3-phase Wye, 4-wire + ground
OVRHSP1602403H	120/240V	3-phase High-Leg, 4-wire + ground
OVRHSP1602403D	240V	3-phase Delta, 3-wire + ground
OVRHSP1603803D	380V	3-phase Delta, 3-wire + ground
OVRHSP1604803D	480V	3-phase Delta, 3-wire + ground
OVRHSP1606003D	600V	3-phase Delta, 3-wire + ground

Product specifications

Electrical	
Maximum surge current rating	160kA per phase, 80kA per mode
Nominal discharge current rating (I-n)	10kA
Operating frequency	47–63Hz
Connection method	Parallel to electrical distribution system
Modes of protection	All Modes (L-N, L-G, N-G, L-L)
Fault rating (SCCR)	200kAIC – no upstream over-current protection device (breaker or fuse) required
Response time	Less than 1 nanosecond
Standard monitoring	Status indicator lights (one per phase) Standard dry (Form “C”) relay contacts Audible alarm with silence button
Mechanical	
Weight	9 kg (20 lbs.)
Enclosure type	Powder coated, impact-resistance steel, weather-proof NEMA 4
Installation location	Indoor/outdoor
Mounting method	Dual mounting flanges
Operating environment	-40° to +70°C (-40° to +185°F)
Altitude	Up to 4000 m (13,000 ft.)
Product design	Parallel design with individually fused MOVs
Regulatory	
UL 1449 4th edition	Type 1
UL 1283	Yes
IEEE C62.41.1, .2, C62.45	Yes
Listed By	UL
EMI/RFI filter attenuation	
Max. attenuation frequency	41dB @ 106kHz
Warranty	
	10-years



Available options*	Suffix number
Surge counter	2
Transient filter (meets UL 1283) Not recommended when using telecommunication rectifiers.	3
Stainless steel enclosure	4
Transient filter and surge counter	B
Transient filter and stainless steel enclosure	C
Surge counter and stainless steel enclosure	D
Transient filter, surge counter and stainless steel enclosure	T

*Add applicable suffix to the end of Model number.
Example: OVRHSP1601201P2

Dimensional specifications

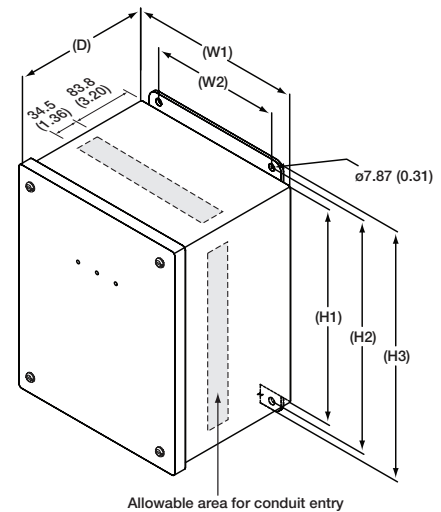

Dim	Millimeters (Inches)
H1	254.0 (10.00)
H2	273.1 (10.75)
H3	292.1 (11.50)
W1	203.2 (8.00)
W2	152.4 (6.00)
D	157.5 (6.20)

Performance data

Model number	Protection mode	MCOV	ANSI/IEEE C62.41.1-2002, C62.41.2-2002, & C62.45-2002 measured limiting voltage			
			B3 ring wave 6kV, 500A	B3/C1 combo wave 6kV, 3kA	C3 combo wave 20kV, 10kA	UL 1449 4th edition 6kV, 3kA VPR
OVRHSP1601201P	L-N	150V	440V	629V	1413V	700V
	L-G	150V	496V	640V	1360V	700V
	N-G	150V	464V	624V	1360V	700V
OVRHSP1602401P	L-N	320V	347V	525V	1069V	1000V
	L-G	320V	1145V	565V	1117V	1000V
	N-G	320V	1090V	507V	930V	1000V
OVRHSP1601202S	L-N	150V	440V	629V	1413V	700V
	L-G	150V	496V	640V	1360V	700V
	L-L	300V	544V	971V	1707V	1200V
	N-G	150V	464V	624V	1360V	700V
OVRHSP1601203Y	L-N	150V	440V	629V	1413V	700V
	L-G	150V	496V	640V	1360V	700V
	L-L	300V	544V	971V	1707V	1200V
	N-G	150V	464V	624V	1360V	700V
OVRHSP1602203Y	L-N	320V	347V	525V	1069V	1000V
	L-G	320V	1145V	565V	1117V	1000V
	L-L	640V	491V	860V	1443V	1800V
	N-G	320V	1090V	507V	930V	1000V
OVRHSP1602403Y	L-N	320V	347V	525V	1069V	1000V
	L-G	320V	1145V	565V	1117V	1000V
	L-L	640V	491V	860V	1443V	1800V
	N-G	320V	1090V	507V	930V	1000V
OVRHSP1602773Y	L-N	320V	347V	525V	1069V	1000V
	L-G	320V	1145V	565V	1117V	1000V
	L-L	640V	491V	860V	1443V	1800V
	N-G	320V	1090V	507V	930V	1000V
OVRHSP1603473Y	L-N	420V	715V	1250V	1910V	1500V
	L-G	420V	829V	1340V	1960V	1500V
	L-L	840V	1130V	2300V	2910V	2500V
	N-G	420V	670V	1230V	1880V	1500V
OVRHSP1602403H	L-N	150V	440V	629V	1413V	700V
	H-N	320V	347V	525V	1069V	1000V
	L-G	150V	496V	640V	1360V	700V
	H-G	320V	1145V	565V	1117V	1000V
	L-L	300V	544V	971V	1707V	1000V
	H-L	470V	980V	1250V	1640V	1500V
	N-G	150V	512V	568V	1090V	800V
OVRHSP1602403D	L-G	320V	759V	982V	1630V	1000V
	L-L	320V	640V	1070V	1550V	1000V
OVRHSP1603803D	L-G	550V	1050V	1500V	2260V	1800V
	L-L	550V	860V	1720V	2340V	1800V
OVRHSP1604803D	L-G	550V	1050V	1500V	2260V	1800V
	L-L	550V	860V	1720V	2340V	1800V
OVRHSP1606003D	L-G	750V	1260V	1960V	2760V	2500V
	L-L	750V	1070V	2260V	2950V	2500V

All OVRHSP systems measured limited voltages are peak values ($\pm 10\%$) measured from the zero reference point and are in compliance with test and evaluation procedures outlined in NEMA LS1-1992 (2000), paragraphs 2.210 and 3.10.

ABB Power Protection LLC

EPSB

Low Voltage Products

5900 Eastport Blvd.

Richmond, VA 23231, USA

new.abb.com/low-voltage/products

We reserve the right to make technical changes or modify the contents of this document without prior notice. With regard to purchase orders, the agreed particulars shall prevail. ABB Power Protection does not accept any responsibility whatsoever for potential errors or possible lack of information in this document.

We reserve all rights in this document and in the subject matter and illustrations contained therein. Any reproduction, disclosure to third parties or utilization of its contents – in whole or in parts – is forbidden without prior written consent of ABB Power Protection. Copyright © 2019 ABB