

Electrical installation solutions for buildings

Quick product references

Index

MCBs wiring diagrams	28/2
RCDs wiring diagrams	28/3
Auxiliary elements	28/11
Protection and safety wiring diagrams	28/16
Command and signaling wiring diagrams	28/30
Control and automation wiring diagrams	28/35
Energy efficiency wiring diagrams	28/39
Overall dimensions	28/48
MCBs and RCDs worldwide marks and approvals	28/164
MDRCs worldwide marks and approvals	28/172

Quick product references

MCBs wiring diagrams

MCBs

S 201 / S 301	S 202 / S 302	S 203 / S 303	S 204 / S 304	S 201 Na / S 301 Na	S 203 Na / S 303 Na
S 751 DR	S 752 DR	S 753 DR	S 754 DR		
S 801	S 802	S 803	S 804		
S 802 PV-M	S 803 PV-M	S 804 PV-M			
SN201	S2011C	S202C	S203C	S204C	

Quick product references

RCDs wiring diagrams

RCDs

F 202

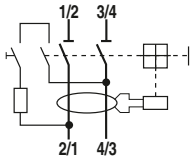

F 204

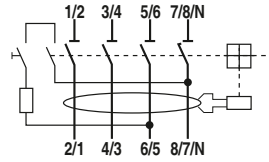

F 204 left neutral

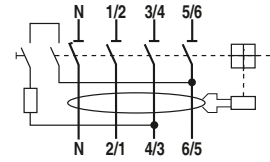

F 202 B

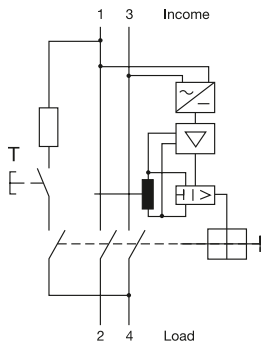

F 204 B

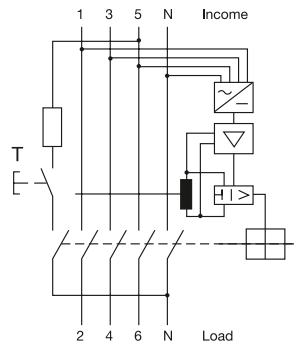

F-ARI 2 Test

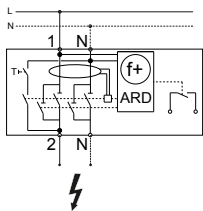

F-ARI 4 Test

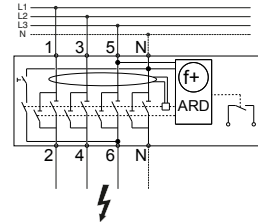

F-ATI 2 Test

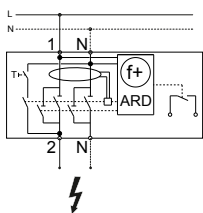

F-ATI 4 Test

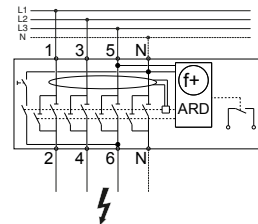

Quick product references

RCDs wiring diagrams

RCD-blocks

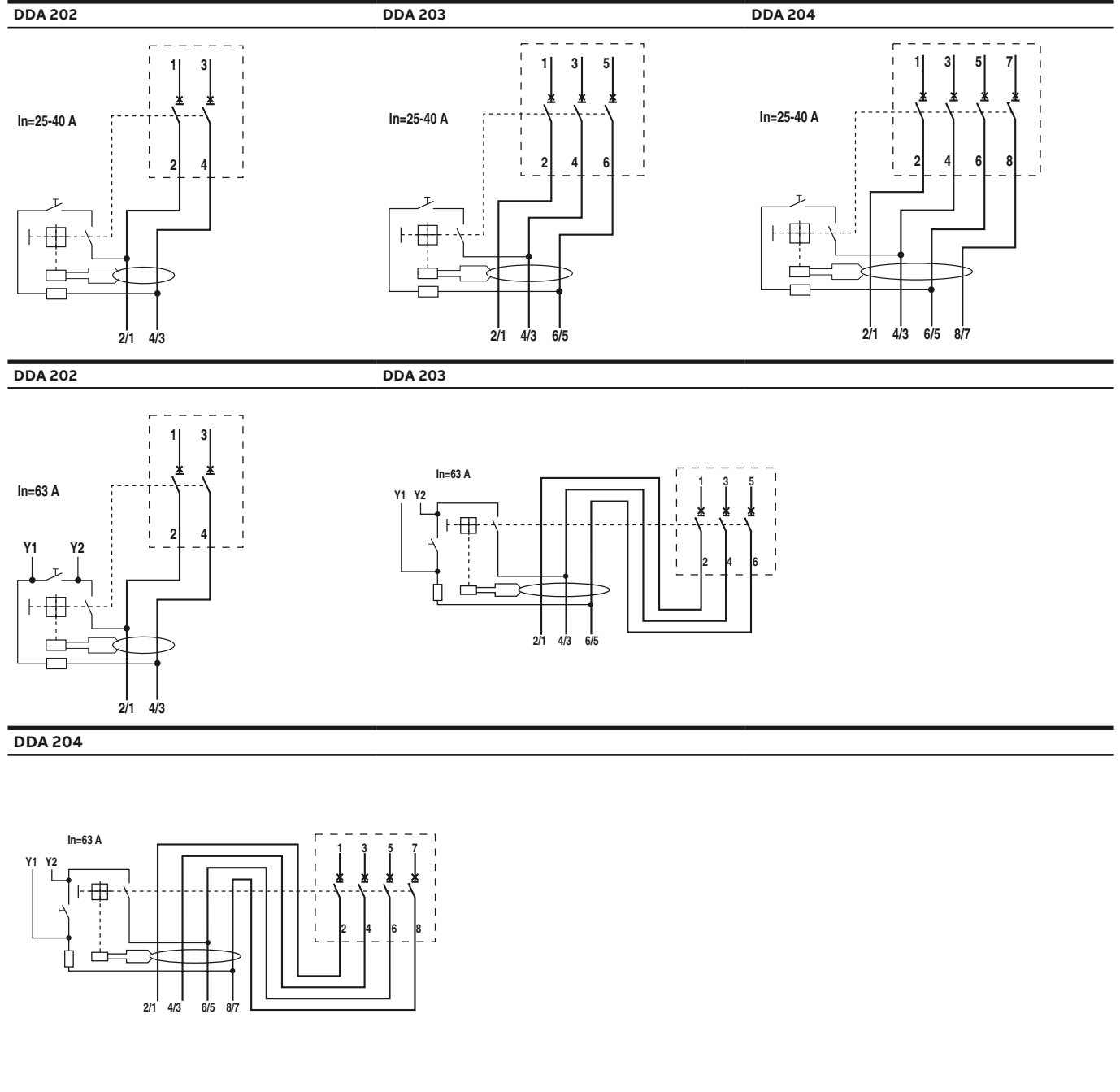

Quick product references

RCDs wiring diagrams

RCD-blocks

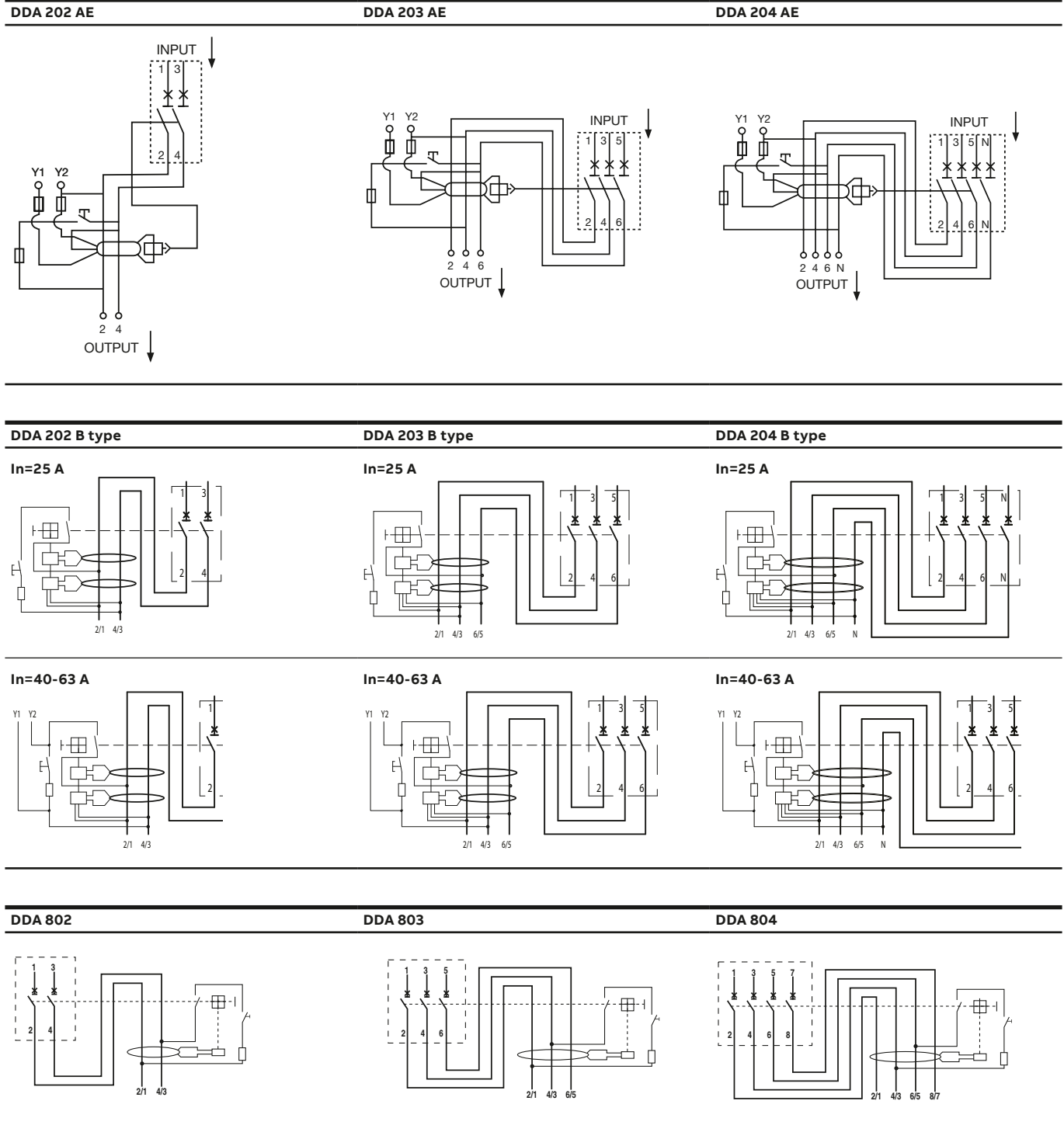

Quick product references

RCDs wiring diagrams

RCBOs

DS201 - DS301C

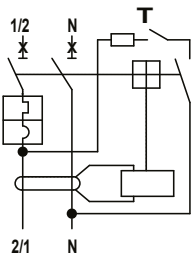

DS202CR

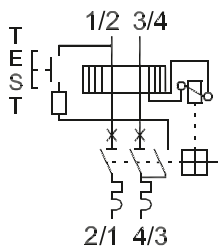

DS202

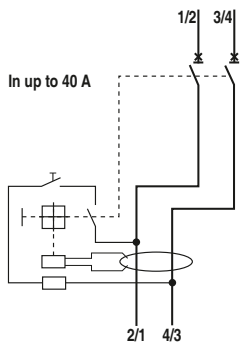

DS203

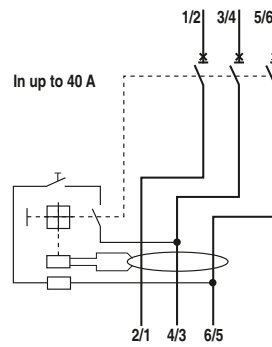

DS204

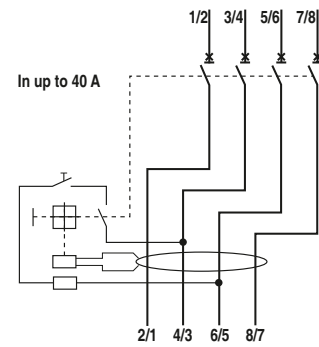

DS202

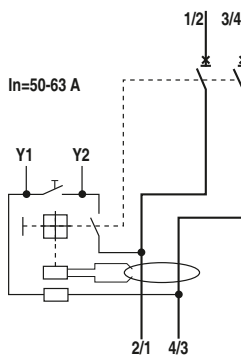

DS203

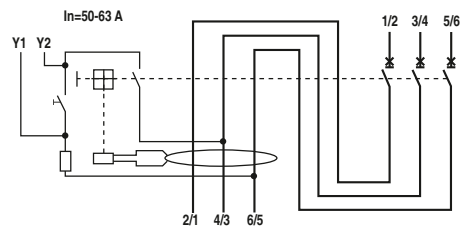

DS204

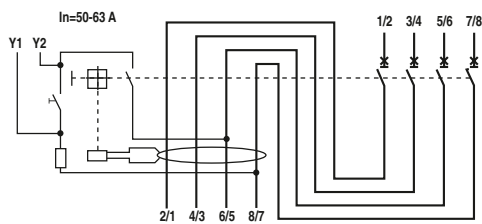

DSE201 - DSE201 M

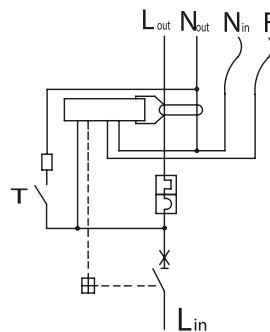

Quick product references

RCDs wiring diagrams

RCBOs

DS203NC

DSE203N M

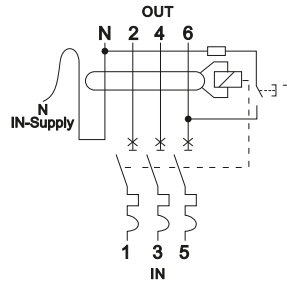
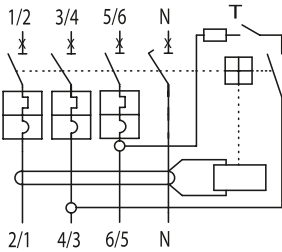

AFDD

S-ARC1

DS-ARC1

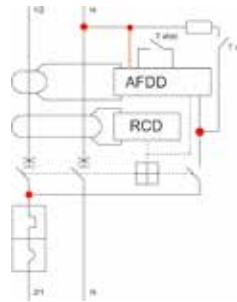
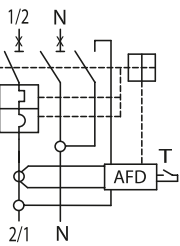

Residual current relays

RD2 residual current relays

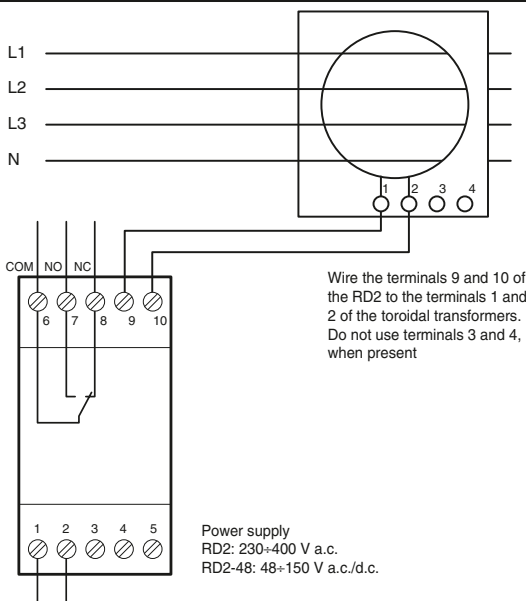

Quick product references

RCDs wiring diagrams

RD3 - undervoltage release wiring

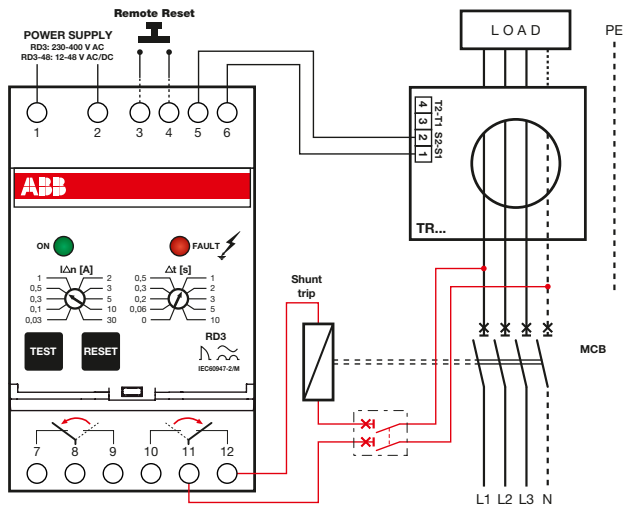

RD3 - shunt trip wiring

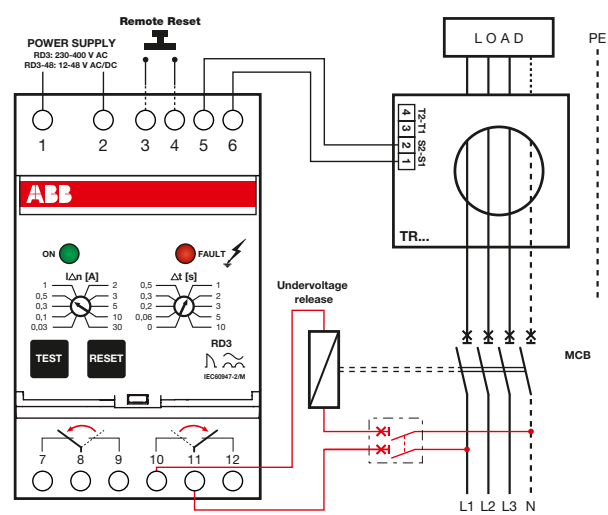

* The residual current protection is not active when this circuit breaker is switch-off

ELR48P - shunt trip wiring

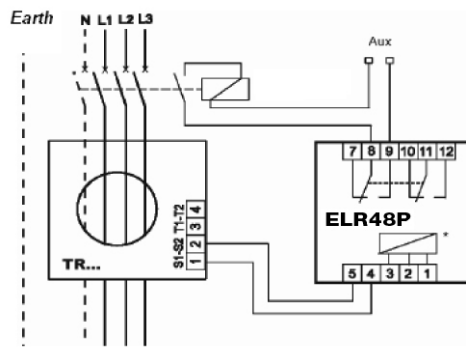

ELR48P - undervoltage release wiring

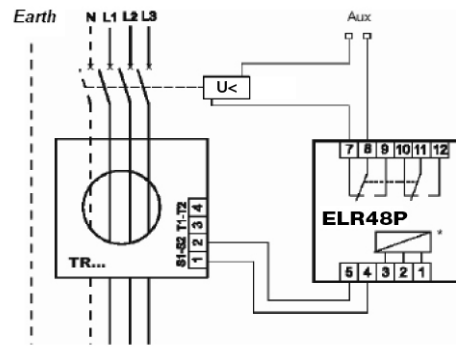

ELR72 - shunt trip wiring

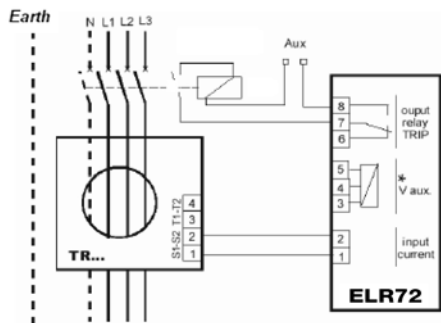

ELR72 - undervoltage release wiring

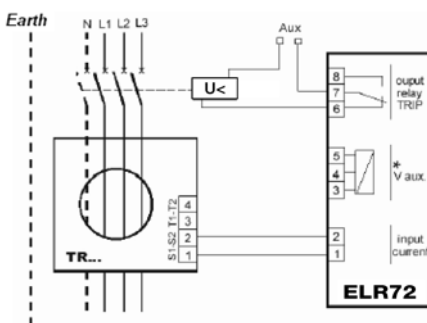

Quick product references

RCDs wiring diagrams

ELR96 - shunt trip wiring

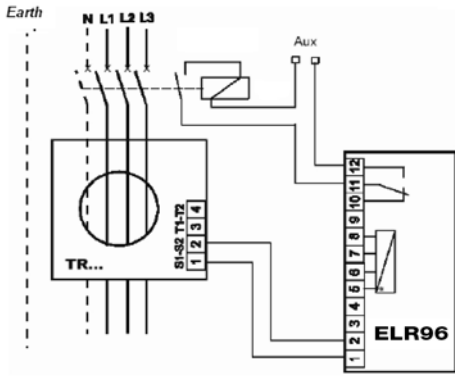

ELR96 - undervoltage release wiring

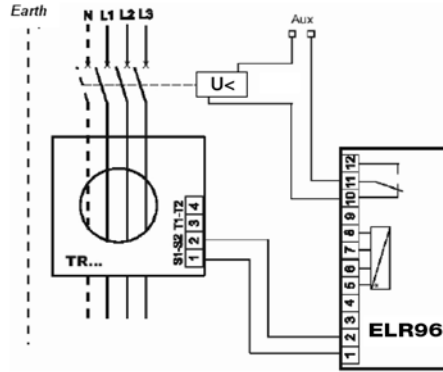

ELR72P - shunt trip wiring

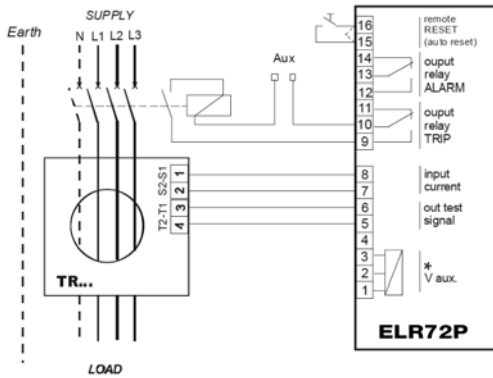

ELR72P - undervoltage release wiring

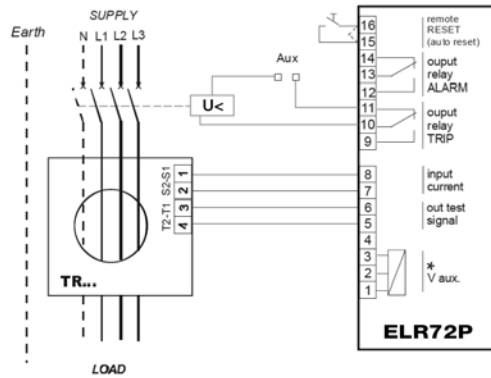

Quick product references

RCDs wiring diagrams

ELR96P - shunt trip wiring

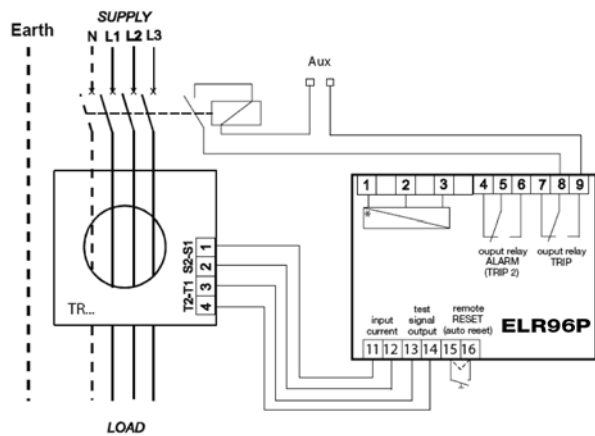

ELR96P - undervoltage release wiring

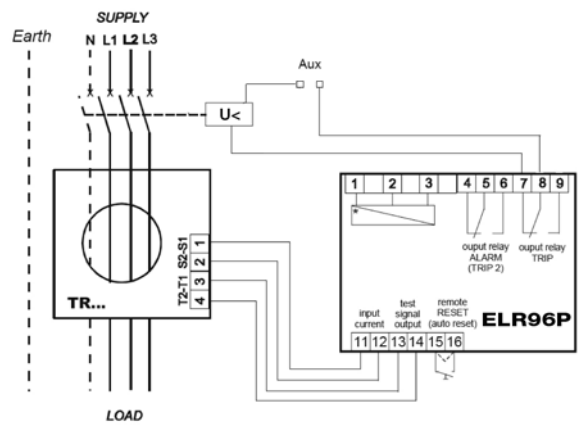

ELR96PF - shunt trip wiring

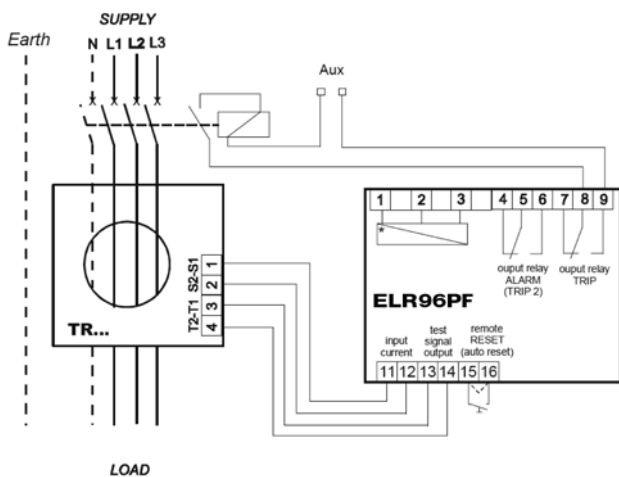

ELR96PF - undervoltage release wiring

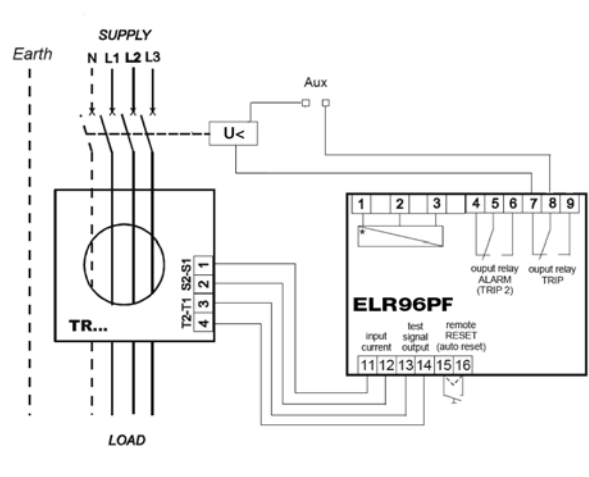

ELR96PD - shunt trip wiring

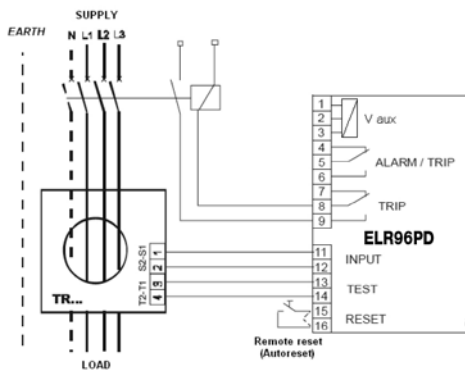

ELR96PD - undervoltage release wiring

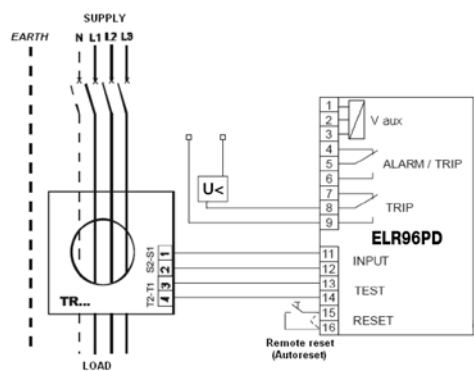

Quick product references

Auxiliary elements

S2C-S/H6R			S2C-H6R		S2C-H6-11R		S2C-H6-20R	
Used as signal contact	Automatic opening	Manual opening	Auxiliary contact	Opening	Auxiliary contact	Opening	Auxiliary contact	Opening
S2C-H6-02R		SN201-S		SN201-IH				
Auxiliary contact	Opening	Auxiliary contact	Automatic opening	Manual opening	Automatic opening	Manual opening		

ABB has a full product range of auxiliary contacts completed by the S2C-S/H6R universal contacts. An auxiliary contact indicates the position of the MCB. A signal contact indicates the MCB position plus the fault event, i.e., overload or short-circuit.

Quick product references

Auxiliary elements

Wiring diagrams for S2C-CM motor operating devices

Low voltage use: 12...30 V AC, 12...48 V DC

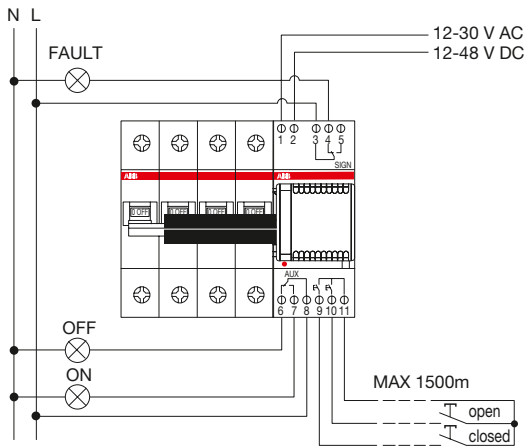

Use at 230 V AC via a TM15/12 bell transformer

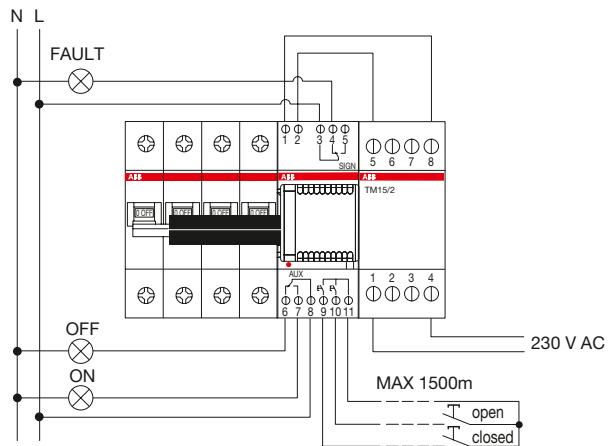

Low voltage use of several motor operating devices: 12...30 V AC, 12...48 V DC

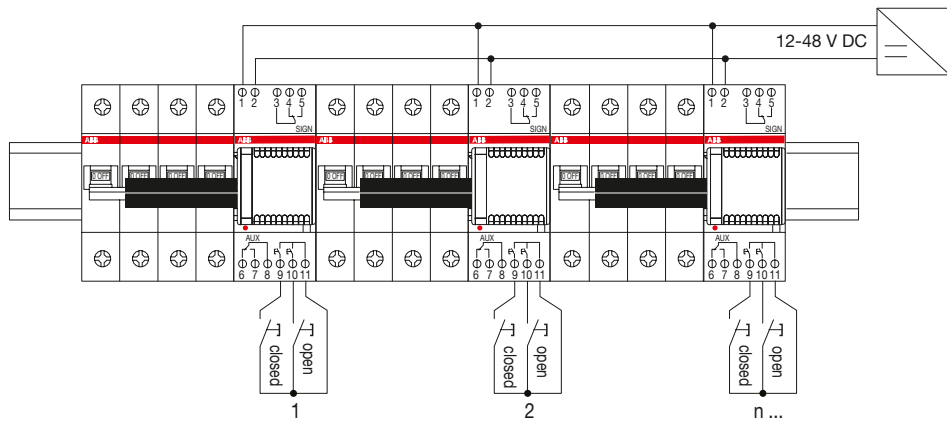

Use of several motor operating devices at 230 V AC via a single safety transformer

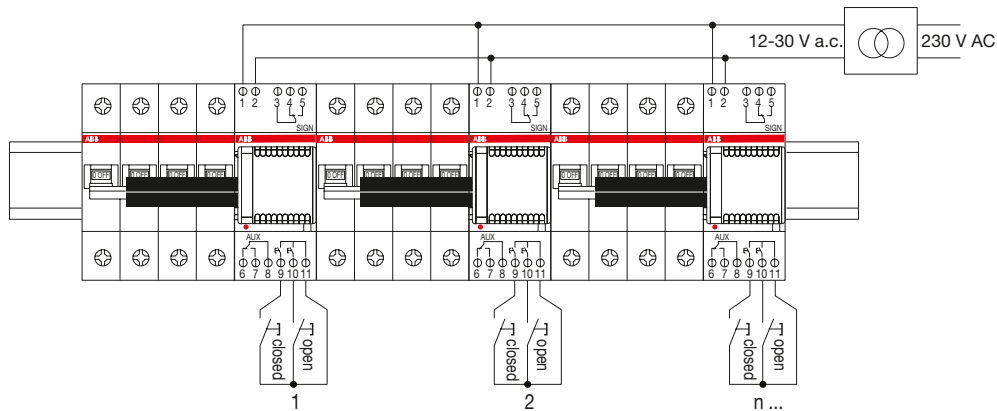

Quick product references

Auxiliary elements

Wiring diagrams for DS2C-CM motor operating devices

Low voltage use 12...30 V AC, 12...48 V DC

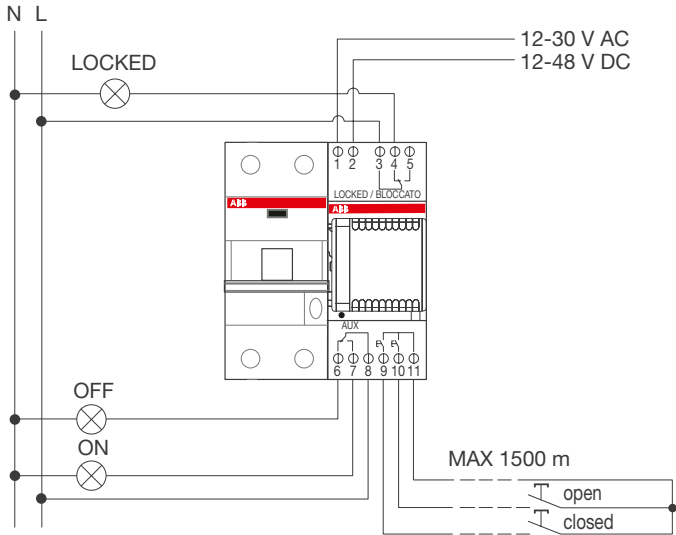

Use at 230 V AC via a TN15/12 transformer

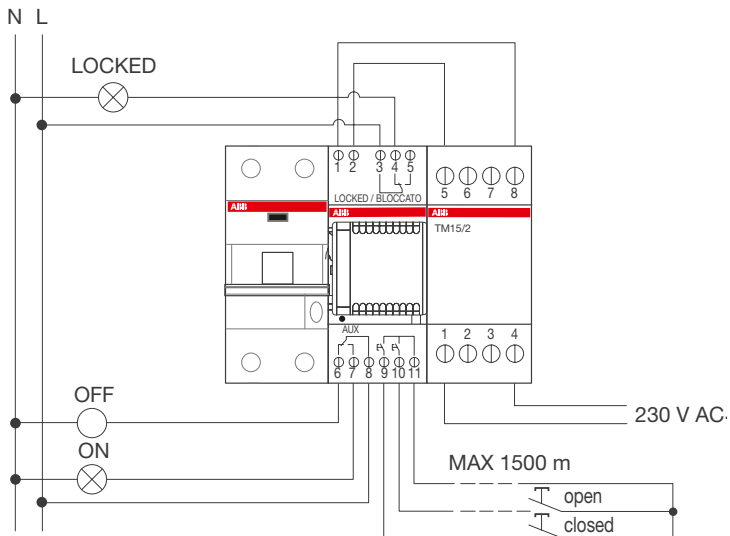

Quick product references

Auxiliary elements

Wiring diagrams for motor operating device F2C-CM and F2C-ARI auto-reclosing unit

Low voltage use: 12...30 V AC, 12...48 V DC

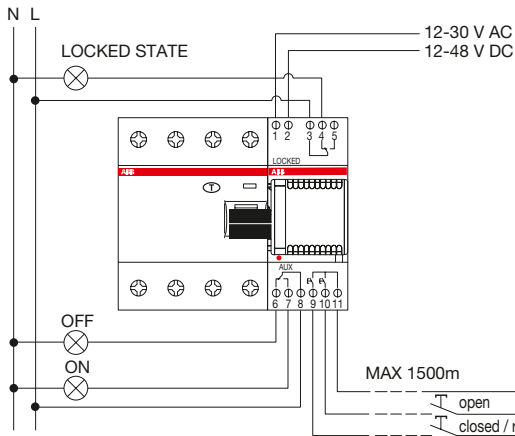

Use at 230 V AC via a TM15/12 bell transformer

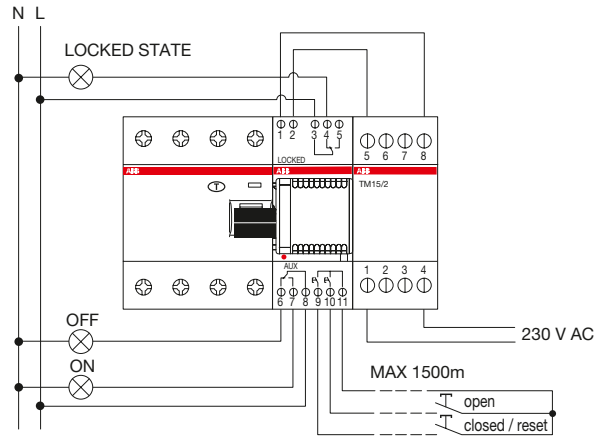

Low voltage use of several motor operating devices or auto-reclosing units: 12-30 V AC, 12-48 V DC

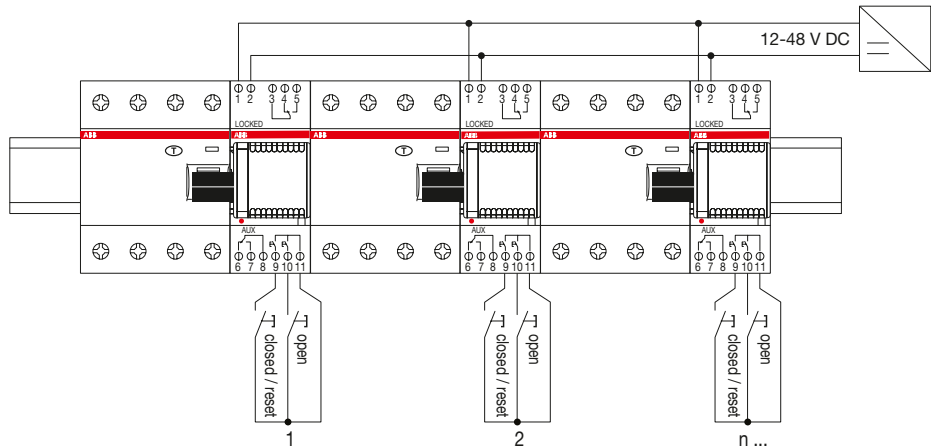

Use of several motor operating devices or auto-reclosing units at 230 V AC via a single transformer

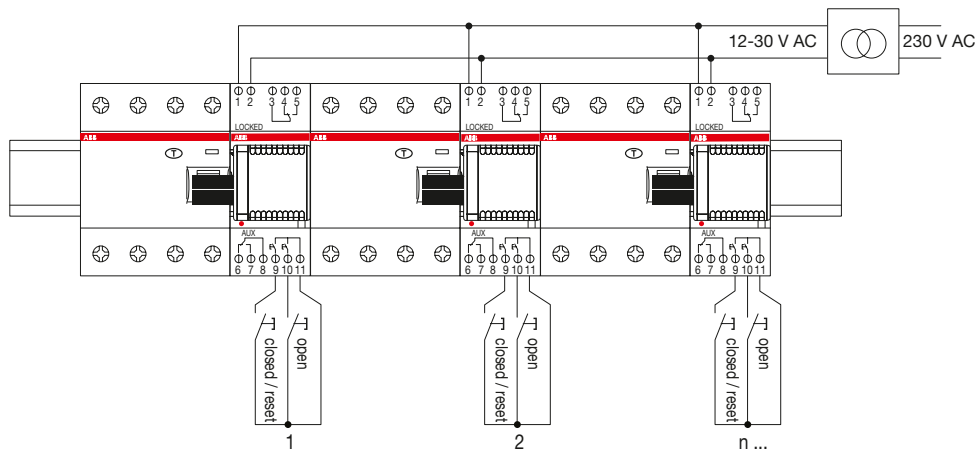

Quick product references

Auxiliary elements

Wiring diagram for F2 CM4 motor operating devices

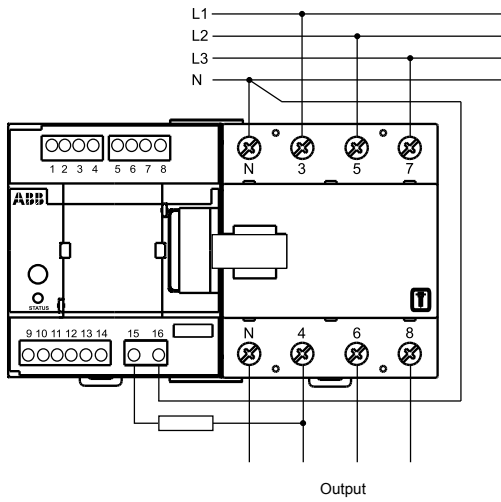

Wiring diagram for F2C-ARH and F2C-ARH-T

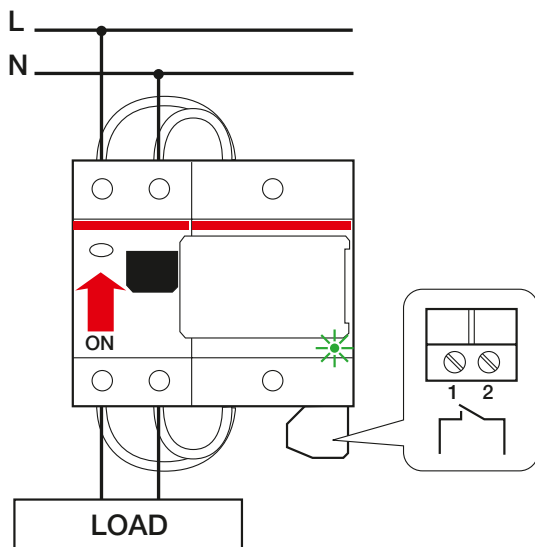

Quick product references

Protection and safety wiring diagrams

Surge Protective Devices - Photovoltaic SPDs - OVR PV

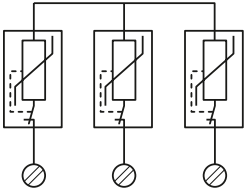

OVR PV T1-T2 QS / OVR PV T2

Surge Protective Devices - Type 1+2 12.5/Type 2/ Type 2+3

Pluggable Type 1+2 12.5/Type 2/ Type 2+3

Single pole Type 2 SPD

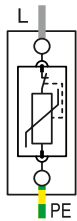

OVR T2-T3 20-275 P QS,
OVR T2 40-275 P QS,
OVR T2-T3 20-440 P QS,
OVR T2 40-275 P QS,
OVR T2 40-350 P QS,
OVR T2 40-350 P TS QS

Single pole Type 1+2 12.5/Type 2 SPD with safety reserve (s)

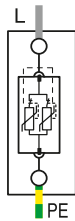

OVR T2 40-275s P QS,
OVR T2 80 275s P QS,
OVR T2 40-440s P QS,
OVR T2 80-440s P QS,
OVR T1-T2 12.5-275s P QS,
OVR T1-T2 12.5-440s P QS

Single pole Type 2/Type 2+3 SPD with remote indication (TS)

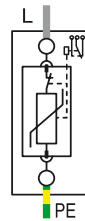

OVR T2-T3 20-275 P TS QS,
OVR T2 40-275 P TS QS,
OVR T2-T3 20-440 P TS QS,
OVR T2 40-440 P TS QS

Single pole Type 1+2 12.5/Type 2 SPD with safety reserve (s) and remote indication (TS)

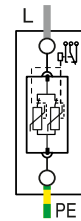

OVR T2 40-275s P TS QS,
OVR T2 80-275s P QS,
OVR T2 40-440s P TS QS,
OVR T2 80-440s P TS QS

Quick product references

Protection and safety wiring diagrams

Surge Protective Devices - Type 1+2 12.5/Type 2/ Type 2+3

Multipole Type 2/ Type 2+3 SPD

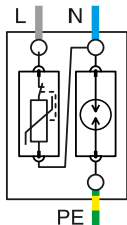

OVR T2-T3 1N 20-275 P QS,
OVR T2 1N 40-275 P QS,
OVR T2 1N 40-350 P QS

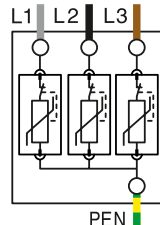

OVR T2-T3 3L 20-275 P QS,
OVR T2 3L 40-275 P QS,
OVR T2 3L 40-350 P QS

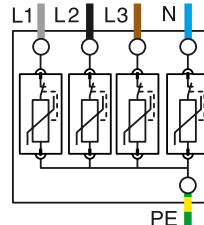

OVR T2-T3 4L 20-275 P QS,
OVR T2 4L 40-275 P QS

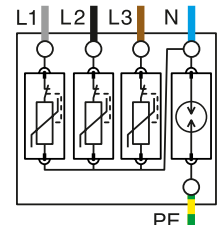

OVR T2-T3 3N 20-275 P QS,
OVR T2 3N 40-275 P QS,
OVR T2 3N 40-350 P QS

Multipole Type 1+2 12.5 / Type 2 SPD with safety reserve (s)

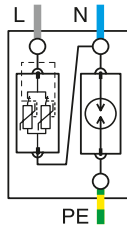

OVR T2 1N 40-275s P QS,
OVR T2 1N 80-275s P QS

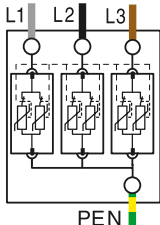

OVR T2 3L 40-275s P QS,
OVR T2 3L 80-275s P QS,
OVR T1-T2 3L 12.5-275s P QS,
OVR T1-T2 3L 12.5-440s P QS

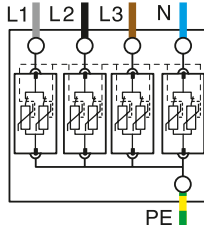

OVR T2 4L 40-275s P QS,
OVR T2 4L 80-275s P QS,
OVR T1-T2 4L 12.5-275s P QS,
OVR T1-T2 4L 12.5-440s P QS

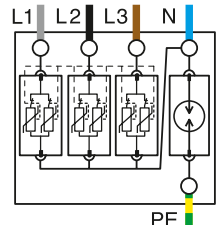

OVR T2 3N 40-275s P QS,
OVR T2 3N 80-275s P QS,
OVR T1-T2 3N 12.5-275s P QS,
OVR T1-T2 3N 12.5-440s P QS

Multipole Type 2/ Type 2+3 SPD with remote indication (TS)

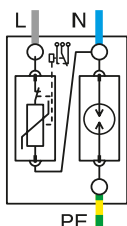

OVR T2-T3 1N 20-275 P TS QS,
OVR T2 1N 40-275 P TS QS,
OVR T2 1N 40-350 P TS QS

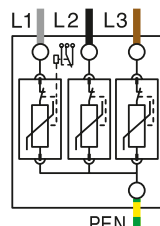

OVR T2-T3 3L 20-275 P TS QS,
OVR T2 3L 40-275 P TS QS,
OVR T2 3L 40-350 P TS QS

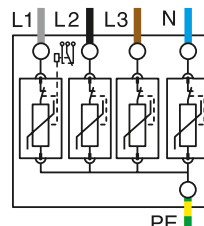

OVR T2-T3 4L 20-275 P TS QS,
OVR T2 4L 40-275 P TS QS

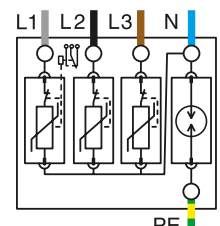

OVR T2-T3 3N 20-275 P TS QS,
OVR T2 3N 40-275 P TS QS,
OVR T2 3N 40-350 P TS QS

Multipole Type 1+2 12.5/Type 2 SPD with safety reserve (s) and remote indication (TS)

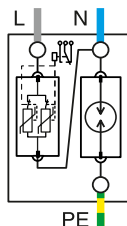

OVR T2 1N 40-275s P TS QS,
OVR T2 1N 80-275s P TS QS,
OVR T1-T2 1N 12.5-275s P TS QS,
OVR T1-T2 1N 12.5-440s P TS QS

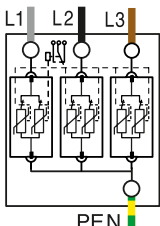

OVR T2 3L 40-275s P TS QS,
OVR T2 3L 80-275s P TS QS,
OVR T1-T2 3L 12.5-275s P TS QS,
OVR T1-T2 3L 12.5-440s P TS QS

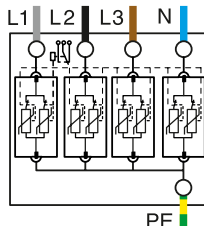

OVR T2 4L 40-275s P TS QS,
OVR T2 4L 80-275s P TS QS,
OVR T1-T2 4L 12.5-275s P TS QS,
OVR T1-T2 4L 12.5-440s P TS QS

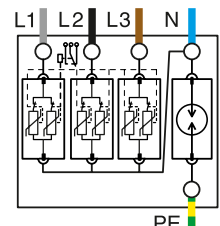

OVR T2 3N 40-275s P TS QS,
OVR T2 3N 80-275s P TS QS,
OVR T1-T2 3N 12.5-275s P TS QS,
OVR T1-T2 3N 12.5-440s P TS QS

Quick product references

Protection and safety wiring diagrams

E90 fuse switch disconnectors

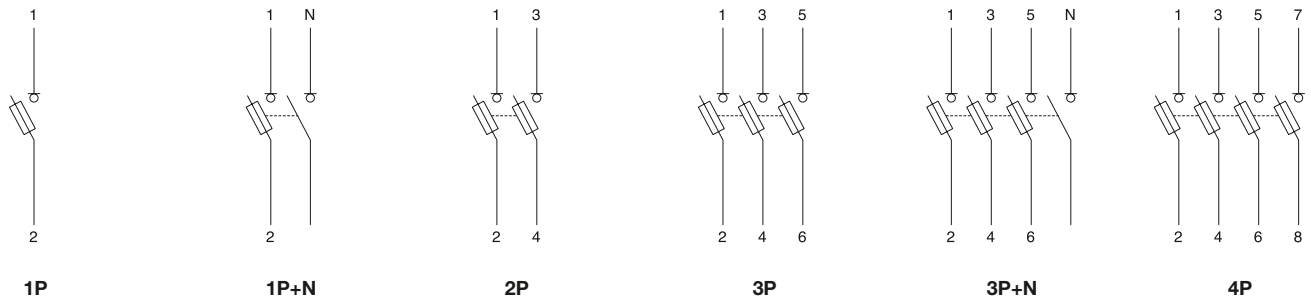

E 90 with blown fuse indicator light in alternate current

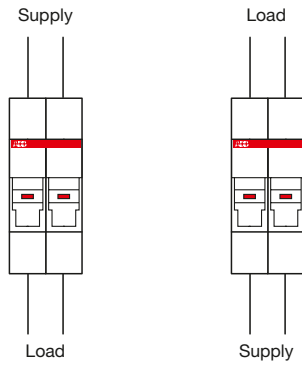

For direct current systems please refer to E 90 PV wiring diagram

E90h fuse holders

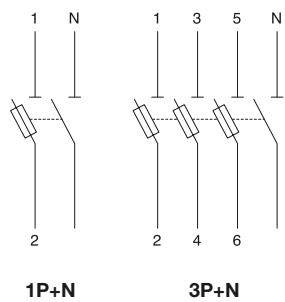

E90 fuse disconnectors and E90/30 CC fuse holders

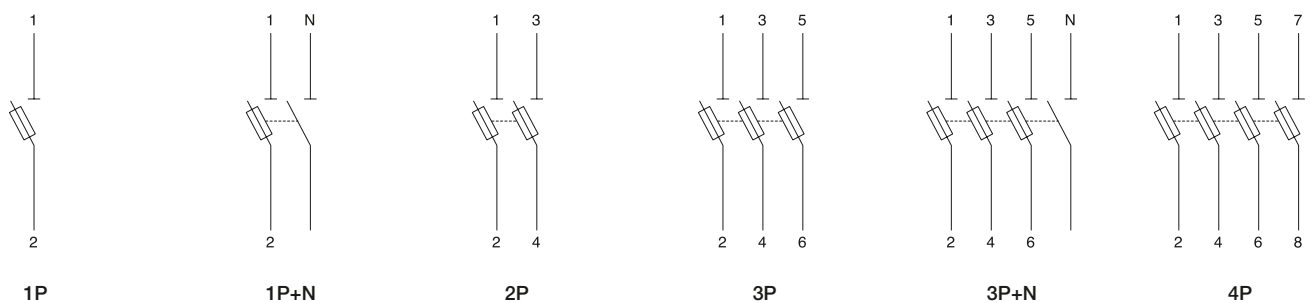

Quick product references

Protection and safety wiring diagrams

E90 PV fuse disconnectors

E 90 PV with blown fuse indicator light in direct current

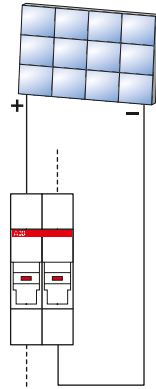
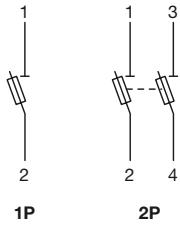

In direct current systems, since the LED allows the current to flow only from positive to negative, the wiring of the blown fuse indicator version should follow the current direction as shown in the diagram

E90 50/125 fuse disconnectors

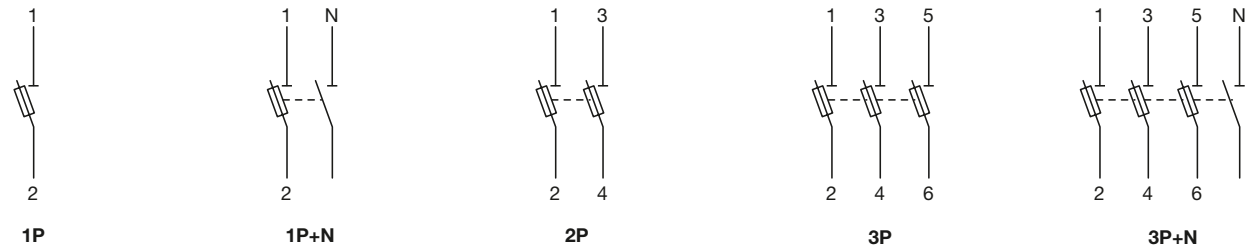

E90 30/60 J fuse holders

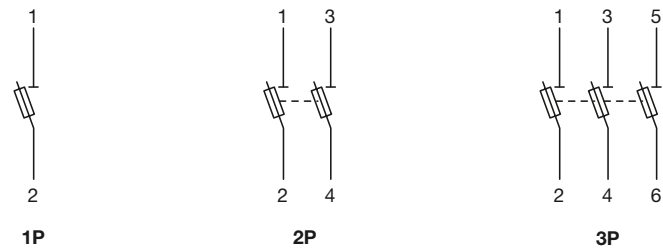

ILTS-E



Quick product references

Protection and safety wiring diagrams

EPD24

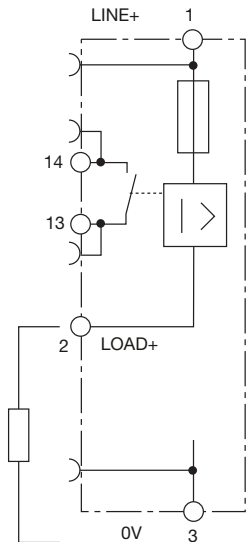

EPD24-TB-101
 without signal input
 with signal output F
 (single signal, NO)
 Operating condition: 13-14 closed
 Fault condition: 13-14 open

SQZ3

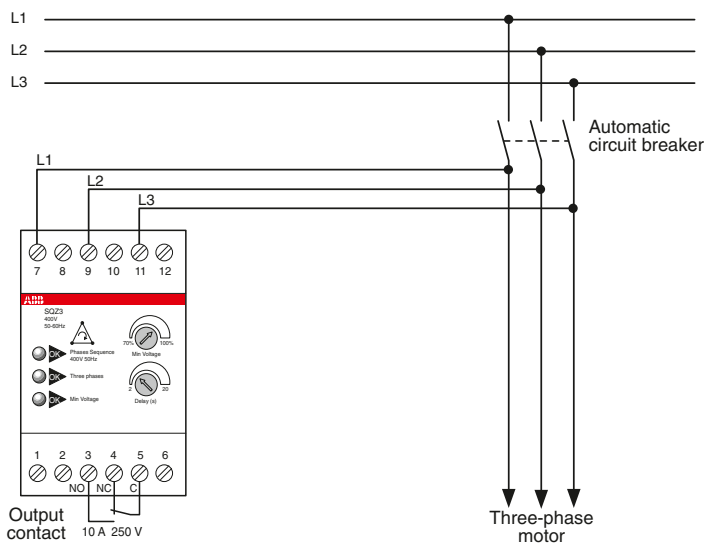

E 236 US 1, E 236 US 2

E236-US 1.1 and US 2.1

E236-US 1.1D

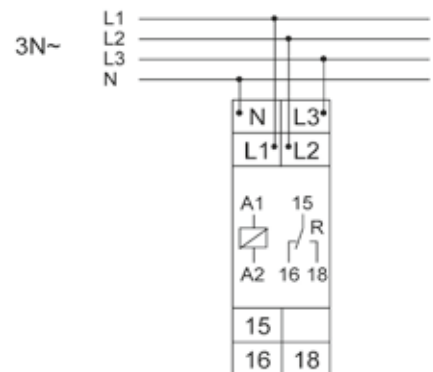
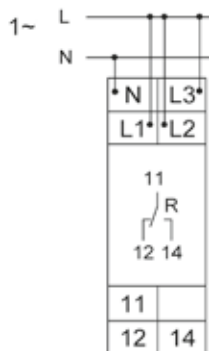
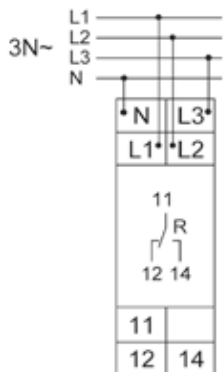
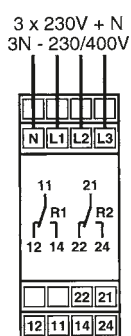

Quick product references

Protection and safety wiring diagrams

ISOLTESTER-DIG, QSD-DIG and SELVTESTER-24 - with transformer with central socket (PC)

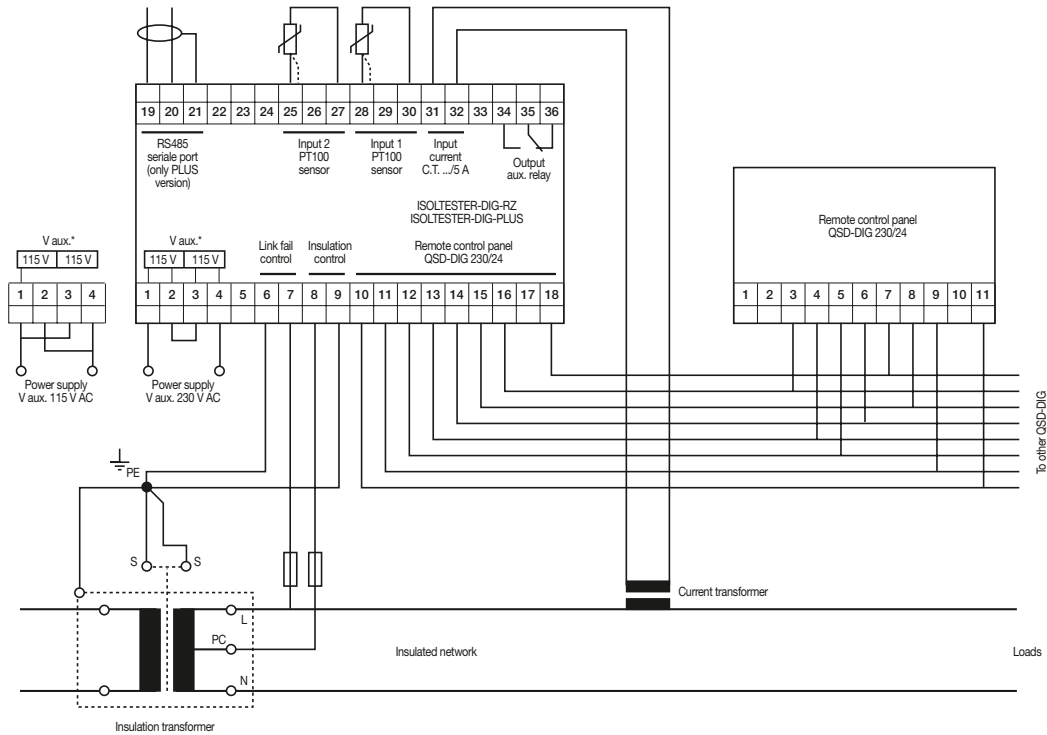

ISOLTESTER-DIG, QSD-DIG and SELVTESTER-24 -

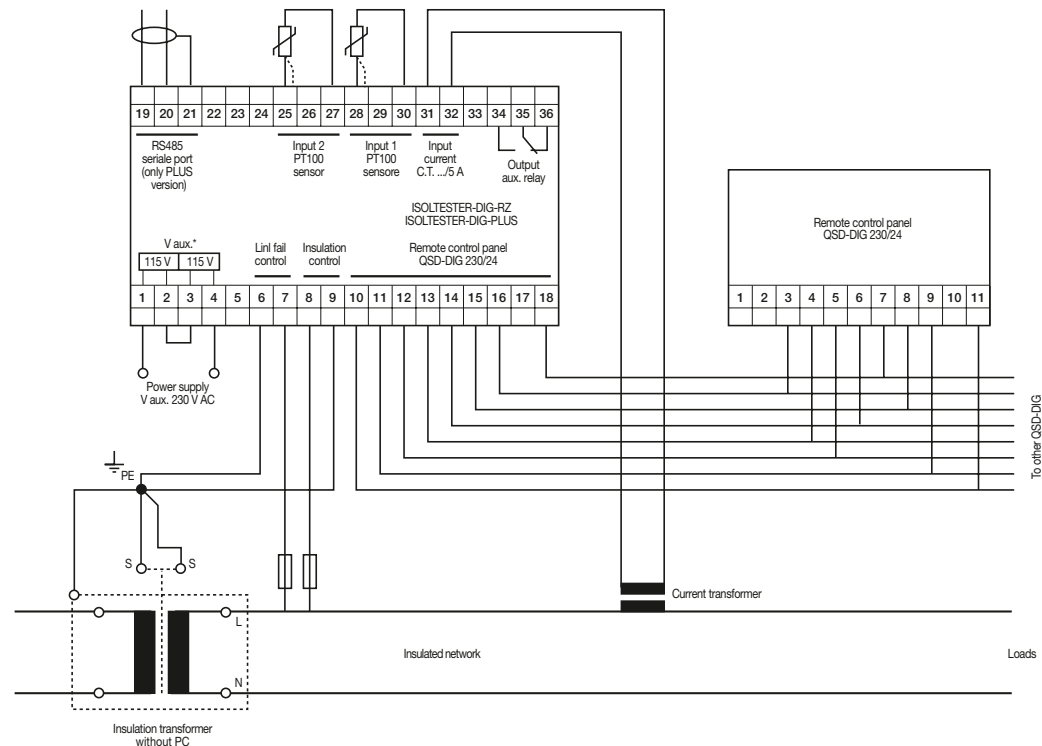

Quick product references

Protection and safety wiring diagrams

ISOLTESTER-DIG, QSD-DIG and SELVTESTER-24 -

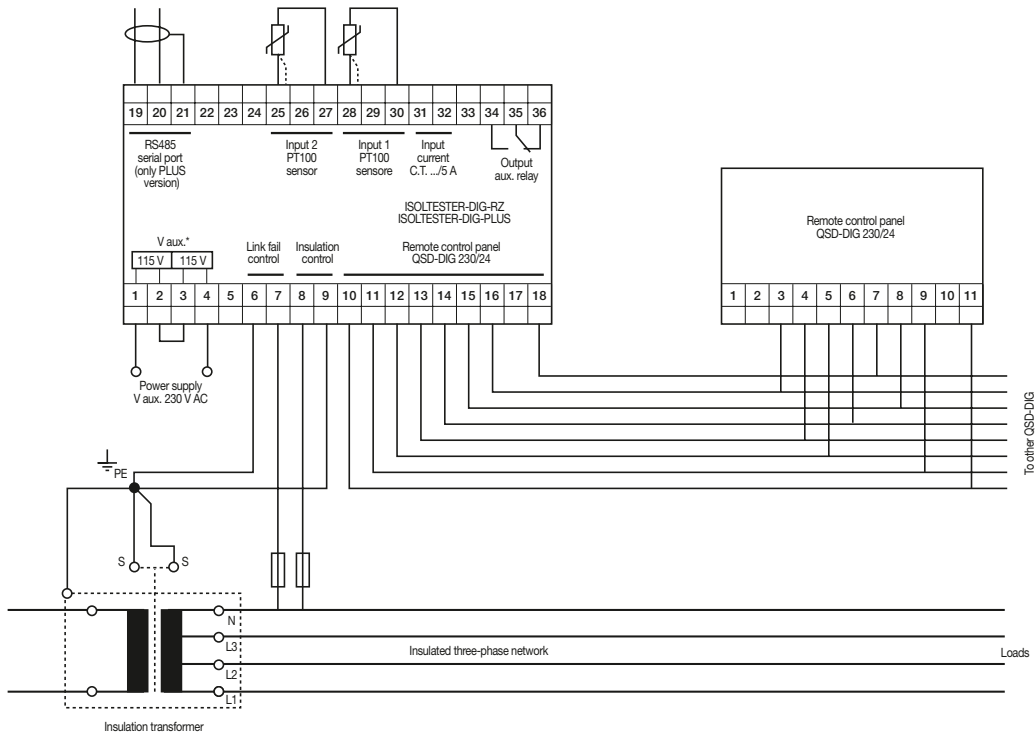

ISOLTESTER-DIG, QSD-DIG and SELVTESTER-24 -

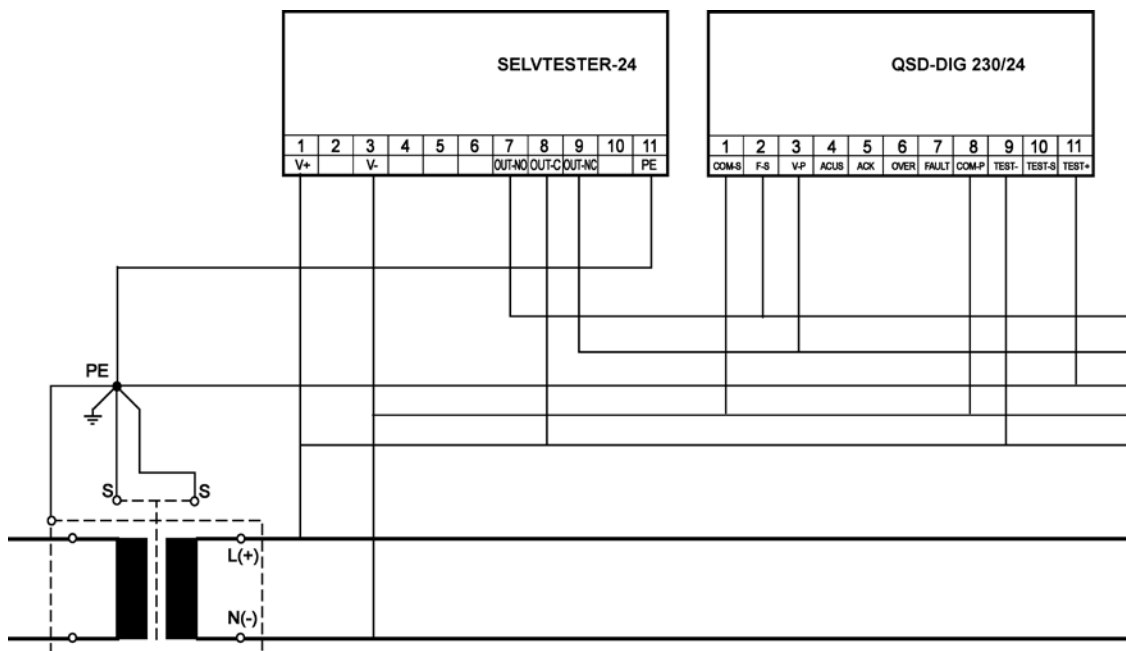

Quick product references

Protection and safety wiring diagrams

ISL-A 24-48

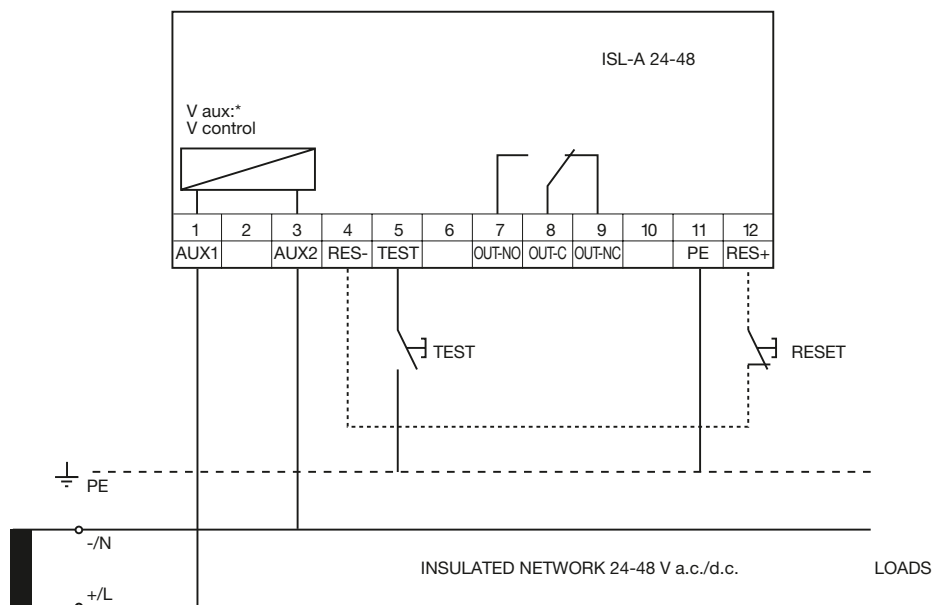

MICROSWITCH SETTINGS

The front microswitches allow the insulation threshold level to be adjusted between 10 and 60 kW, as shown below:

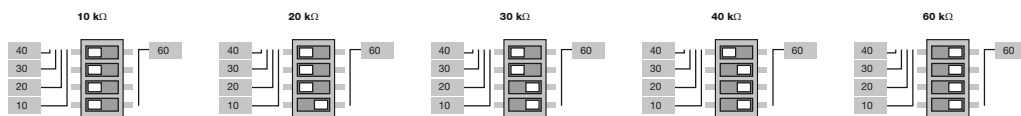

Quick product references

Protection and safety wiring diagrams

ISL-A 115 and ISL-A 230

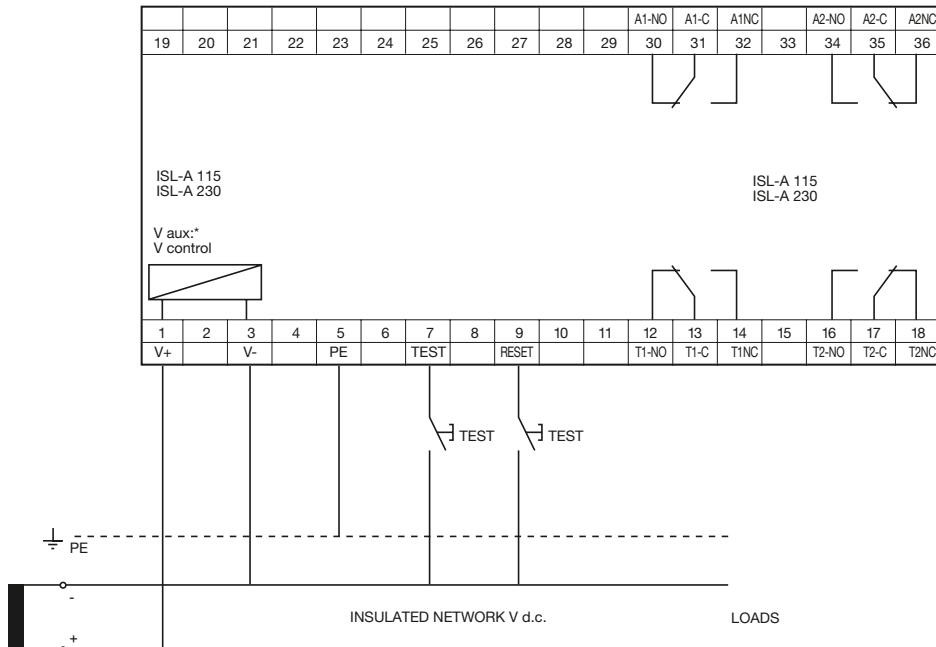

MICROSWITCH SETTINGS

The front microswitches are used for adjusting the insulation threshold level, enabling the fail-safe function and configuring the reset mode for both the alarm and trip thresholds.

Microswitches A, B, C, D for programming the trip and alarm thresholds:

ALARM		TRIP	
300 kΩ:	A=0, B=0, C=0, D=0	100 kΩ:	A=0, B=0, C=0, D=0
150 kΩ:	A=1, B=0, C=0, D=0	60 kΩ:	A=1, B=0, C=0, D=0
80 kΩ:	A=1, B=1, C=0, D=0	40 kΩ:	A=1, B=1, C=0, D=0
50 kΩ:	A=1, B=1, C=1, D=0	20 kΩ:	A=1, B=1, C=1, D=0
30 kΩ:	A=1, B=1, C=1, D=1	10 kΩ:	A=1, B=1, C=1, D=1

Microswitch E for configuring the FAIL SAFE mode

E=0 fail safe mode disabled

E=1 fail safe mode enabled

Microswitch F for configuring the RESET mode

F=0 manual reset

F=1 automatic reset

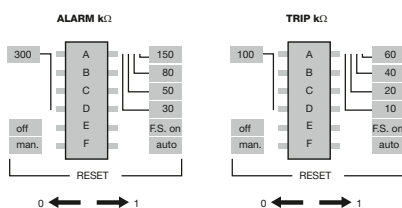

Quick product references

Protection and safety wiring diagrams

ISL-A 600

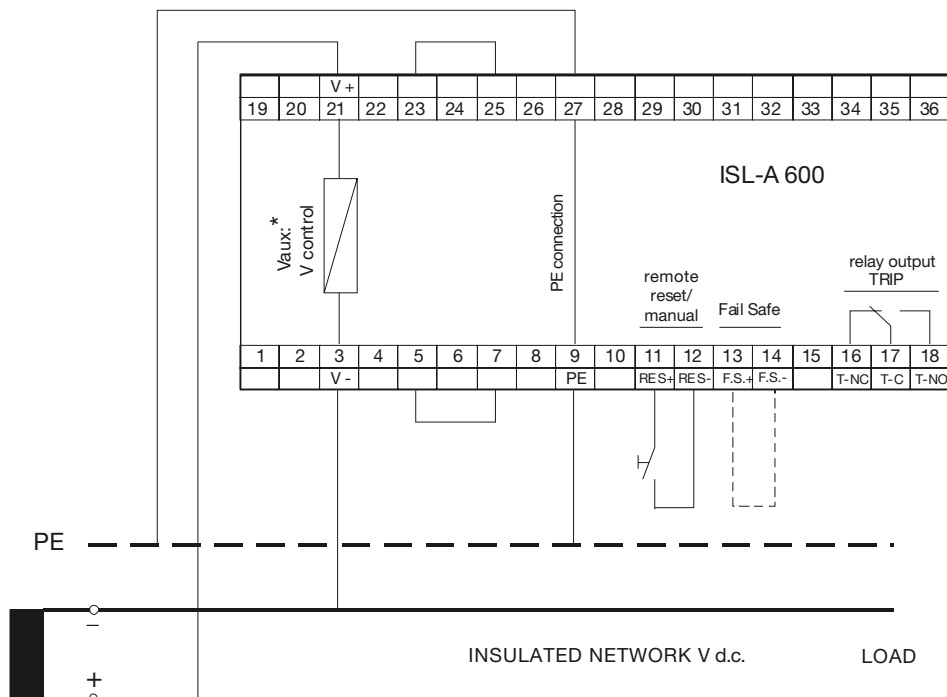

ISL-C 230

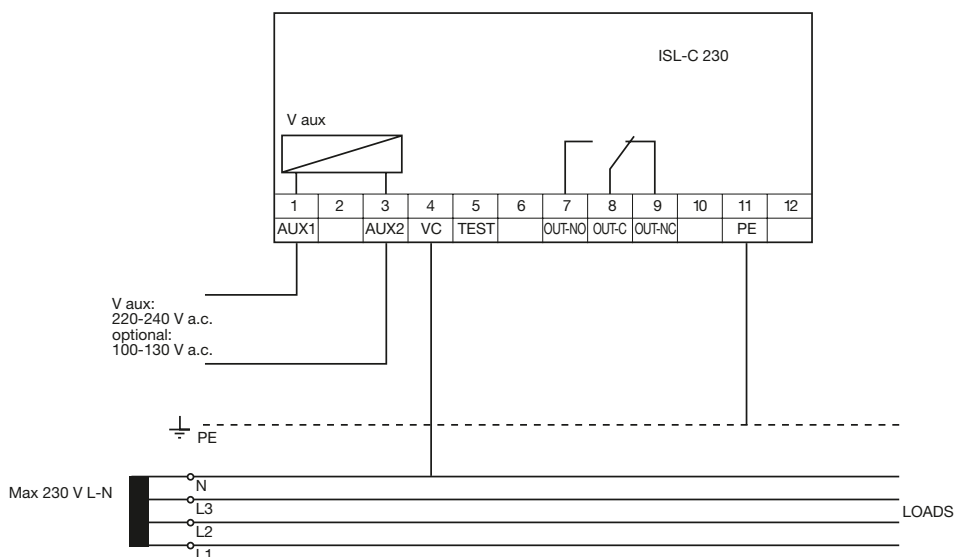

Quick product references

Protection and safety wiring diagrams

ISL-C 440

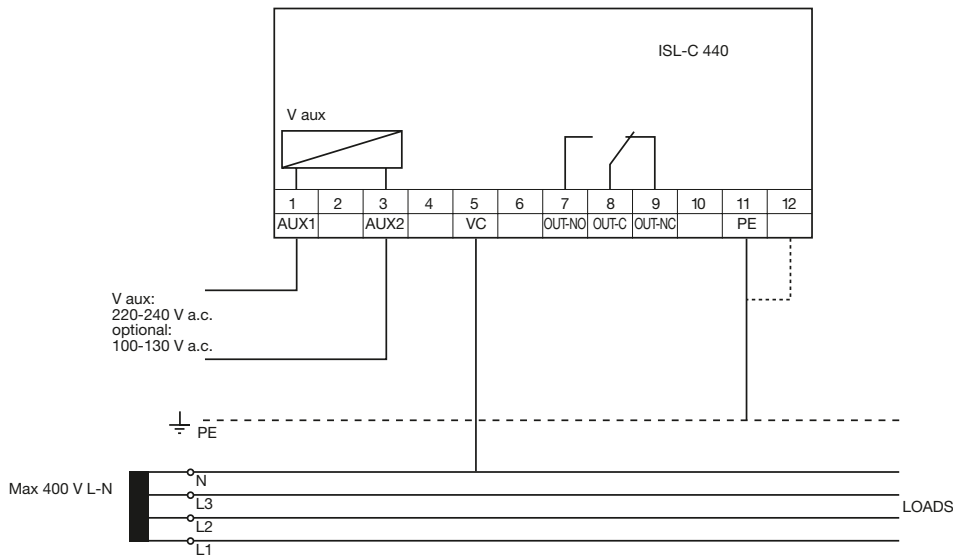

MICROSWITCH SETTINGS

The front microswitches are used for adjusting the insulation threshold level between 10 and 150 kW, as shown below:

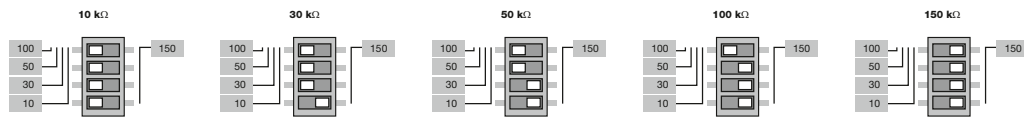

Quick product references

Protection and safety wiring diagrams

ISL-C 600

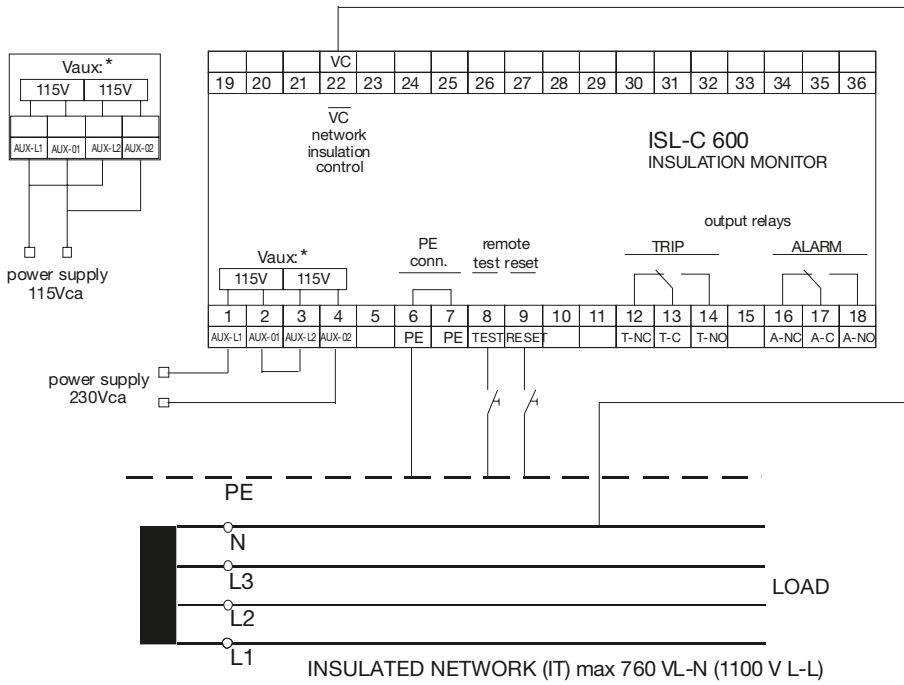

Max 760V L-N

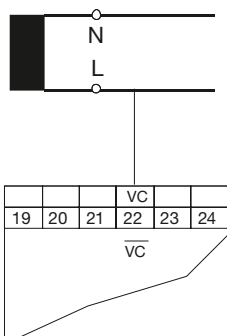

Three-phase network without neutral
Max 760V L-L

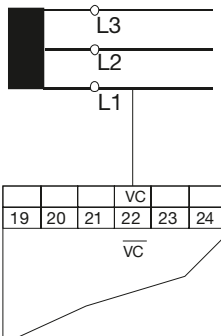

Three-phase network with neutral
Max 1100V L-L

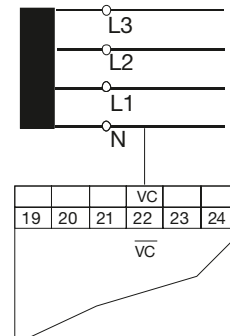

Quick product references

Protection and safety wiring diagrams

ISL-MOT 1000

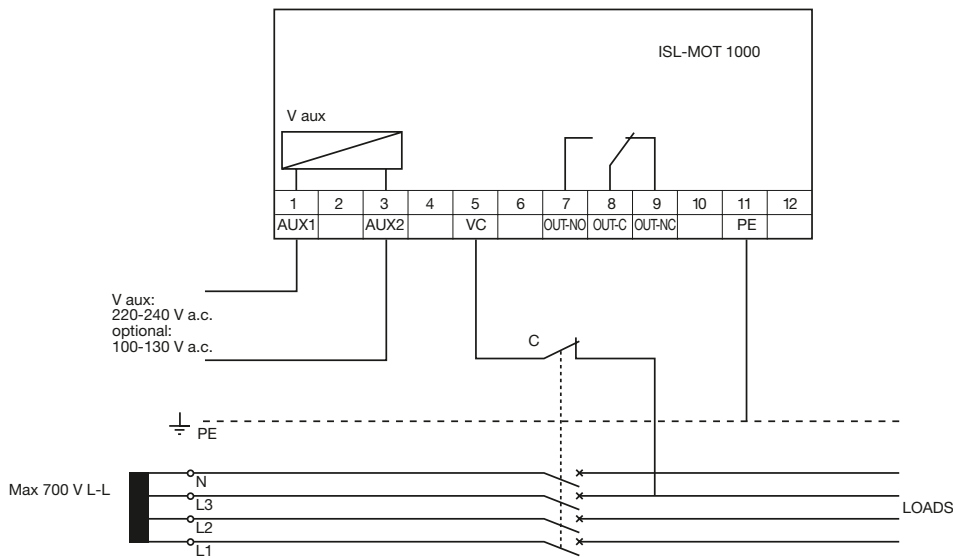

MICROSWITCH SETTINGS

The front microswitches are used for adjusting the insulation threshold level between 0.1 and 10 MW. A total of 7 microswitches are used, divided into two groups as shown below:

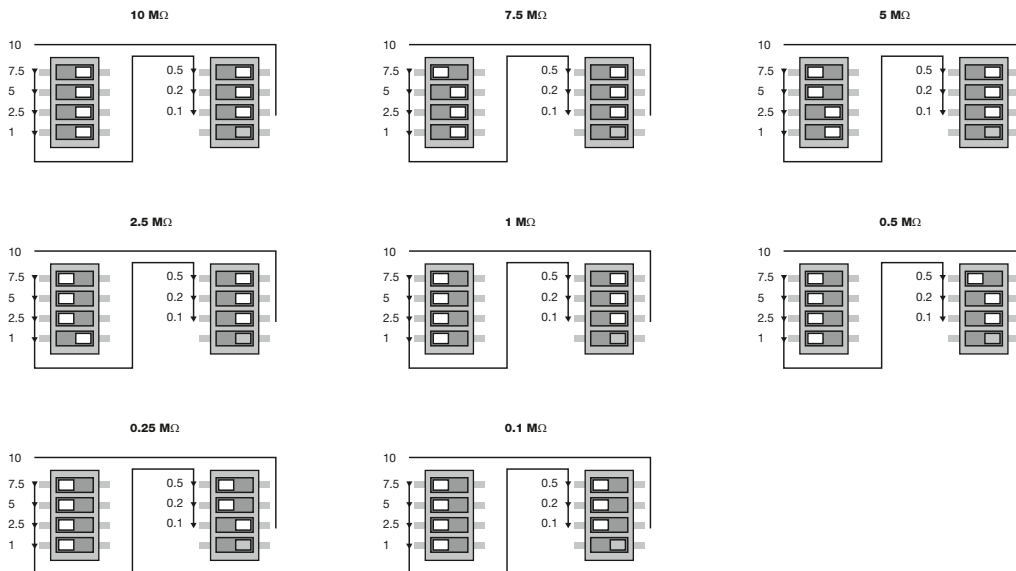

Quick product references

Protection and safety wiring diagrams

 TI

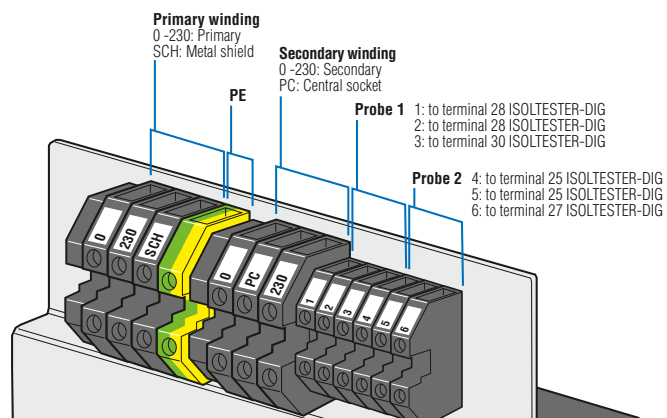

Quick product references

Command and signaling wiring diagrams

E200/SD 200/SHD 200



E210



ON / OFF switch

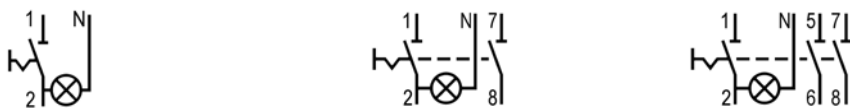

Off switches with indicator lamps



Change-over switches

Quick product references

Command and signaling wiring diagrams

E210 group switches

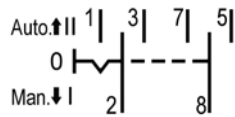
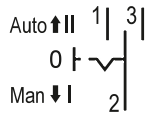

E210 control switches

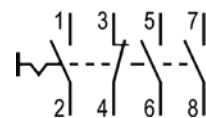
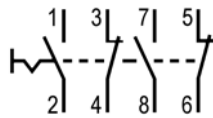
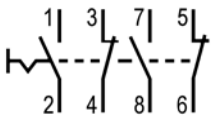

E210 pushbutton

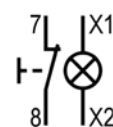
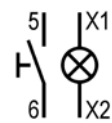
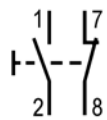

E210 indicator Light

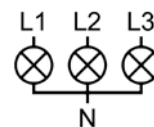
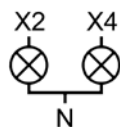

ESB EN

Contact Blocks

EH 04-20

EH 04-11

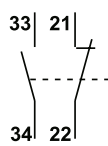

Quick product references

Command and signaling wiring diagrams

STD

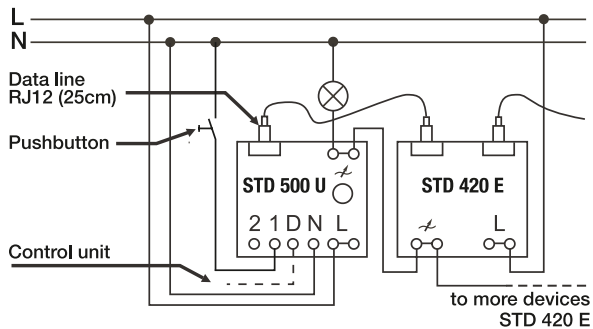

STD-500 U

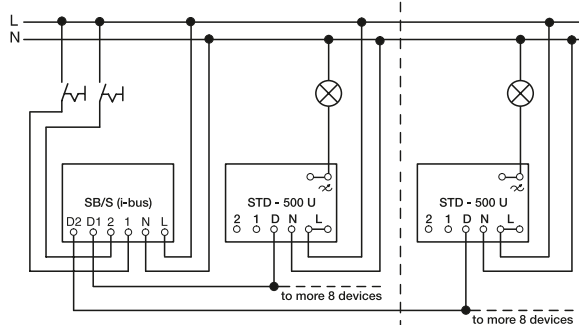

STD-500 U, SB/S or PSB/S

TM-C, TM-S, TM-I

TM-C

Label on product:
12-24 V output

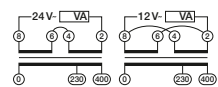

115-230 V output

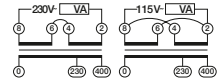

TM-S, TM-I

Label on product:
12-24 V output TM-S

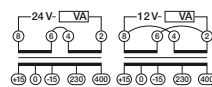

24-48 V output TM-S

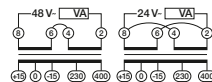

115-230 V output TM-I

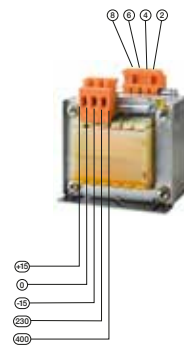
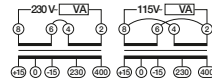

Primary voltage TM-I, TM-S

		Cable 2	
		230	400
Cable 1	-15	215V	385V
	0	230V	400V
	15	245V	415V

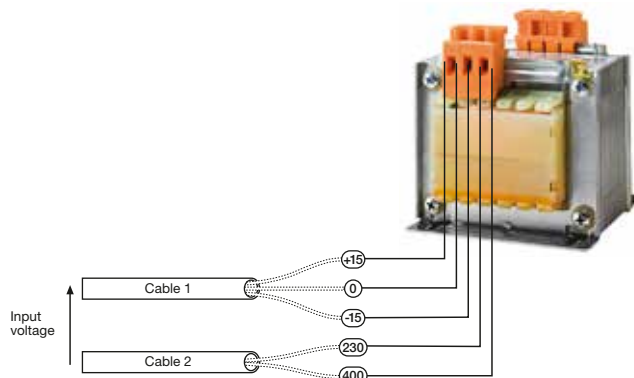

Quick product references

Command and signaling wiring diagrams

TS-C

TS10/12-24 C

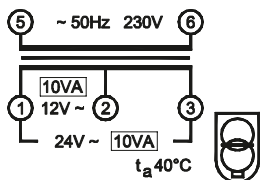

TS16/12-24 C

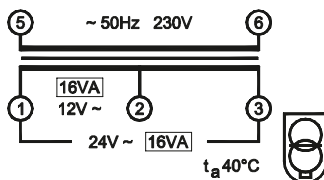

TS25/12-24 C

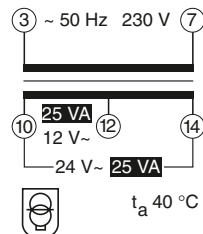

TS40/12-24 C

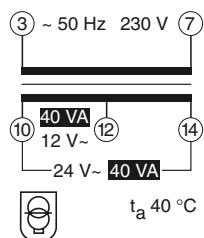

TS63/12-24 C

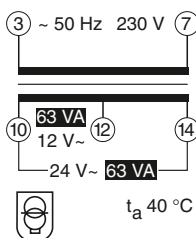

TS100/12-24 C

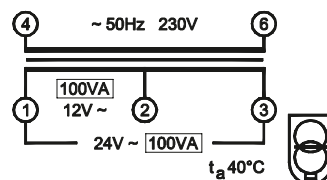

TM

TM10/12

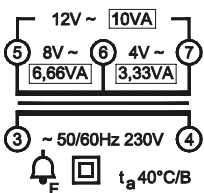

TM10/24

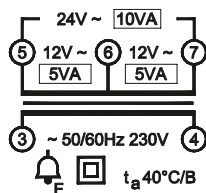

TM15/12

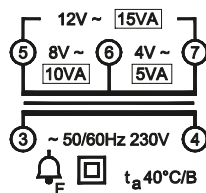

TM15/12 ES

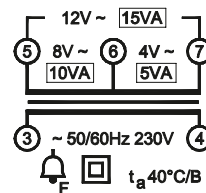

TM15/24

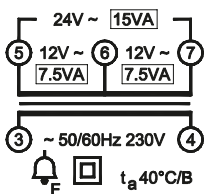

TM30/12

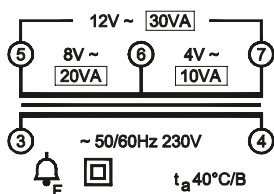

TM30/24

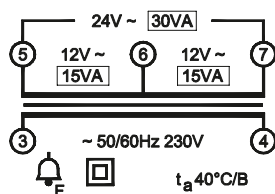

TM40/12

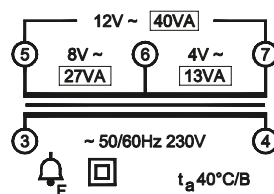

TM40/24

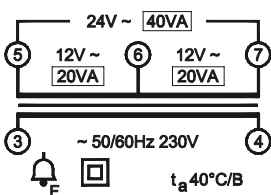

Quick product references

Command and signaling wiring diagrams

TS

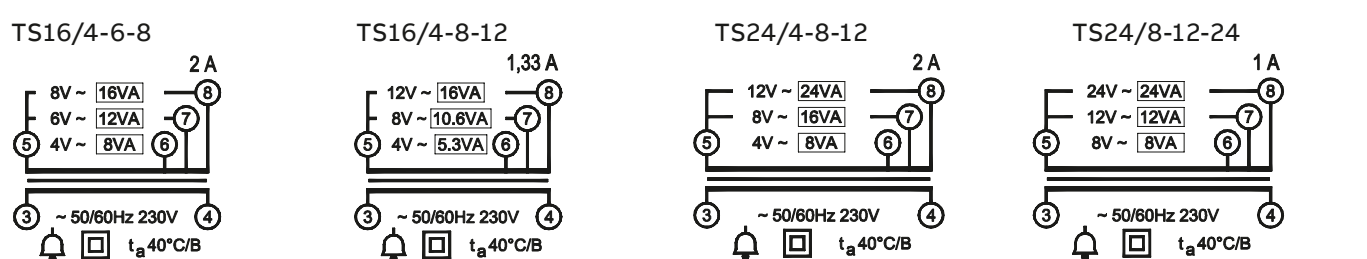
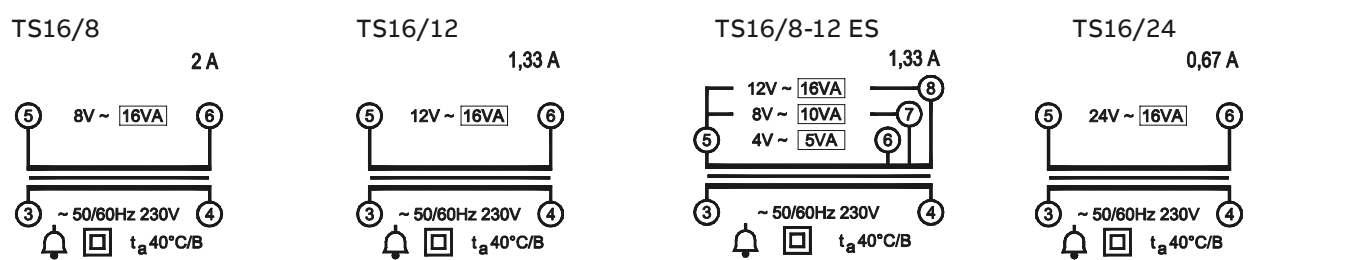
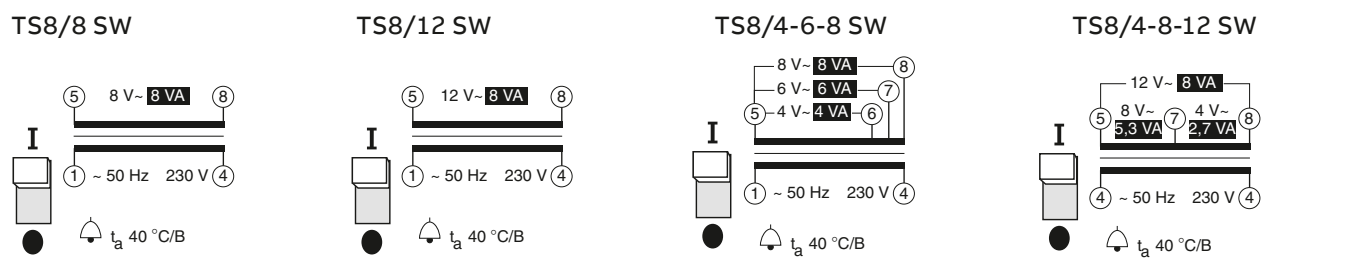
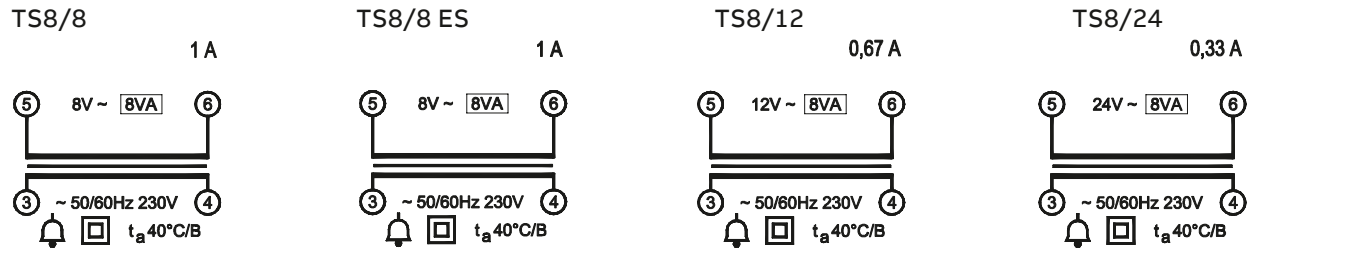

SM, RM...

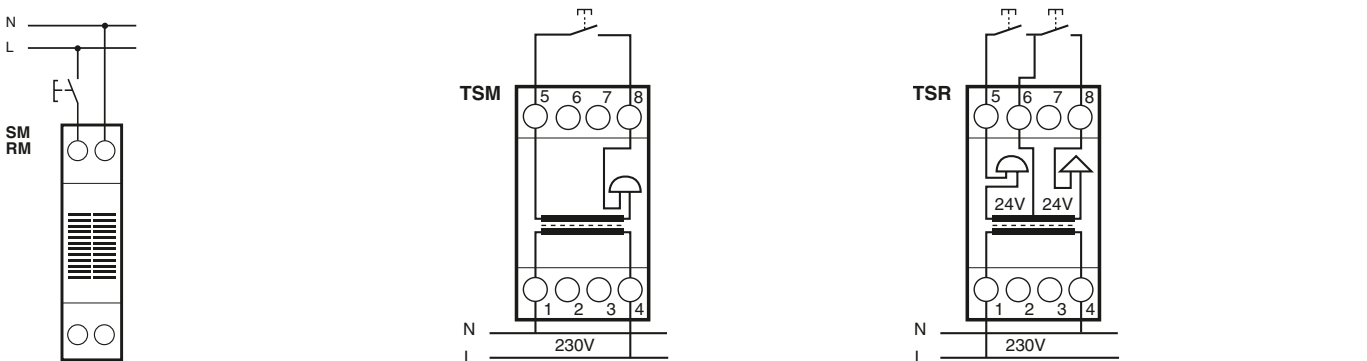

Quick product references

Control and automation wiring diagrams

E 232

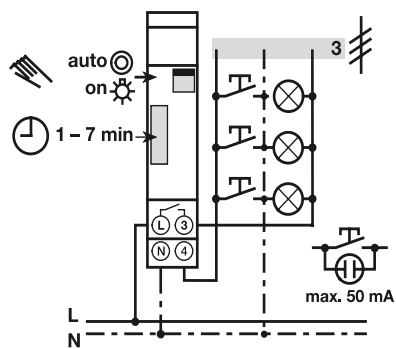

E 232-230 3 conductor

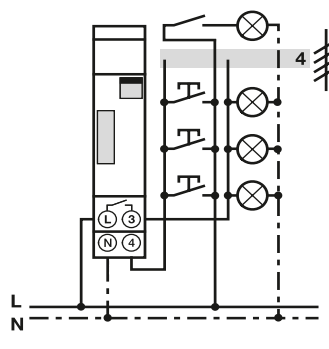

E 232-230 4 conductor

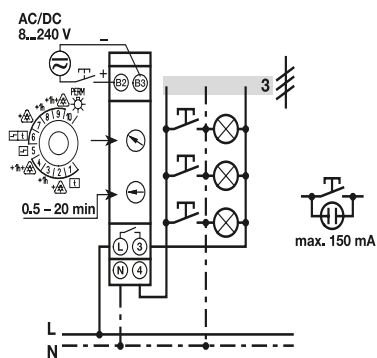

E 232E-8/230 Multi 10 3 conductor

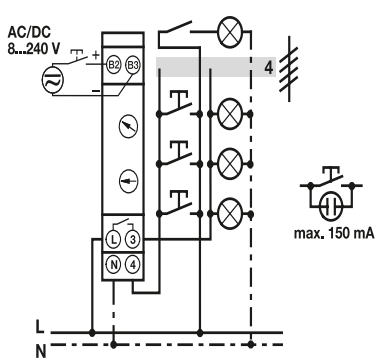

E 232E-8/230 Multi 10 4 conductor

Quick product references

Control and automation wiring diagrams

E 232

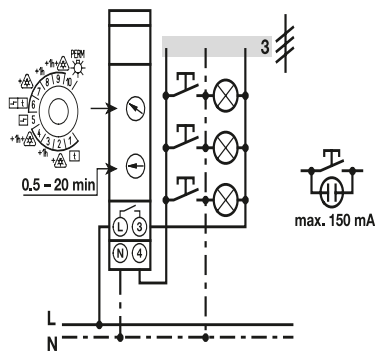

E 232E-230 Multi 10 3 conductor

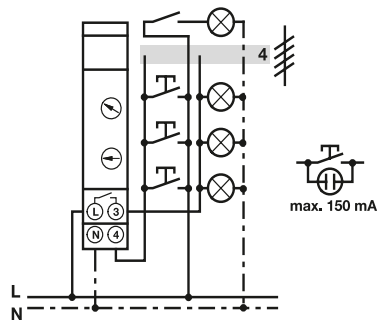

E 232E-230 Multi 10 4 conductor

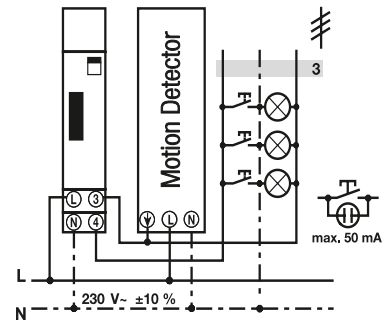

E 232E-8/230 Multi 10 3 conductor
E 232E 8/230 3 conductor
E 232E 230 Multi 10 3 conductor
E 232E 230 N 3 conductor
E 232-230 3 conductor

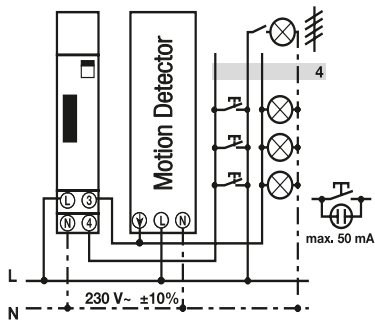

E 232E-8/230 Multi 10 4 conductor
E 232E 8/230 4 conductor
E 232E 230 Multi 10 4 conductor
E 232E 230 N 4 conductor
E 232-230 4 conductor

Quick product references

Control and automation wiring diagrams

E 234

CT-MFD.21

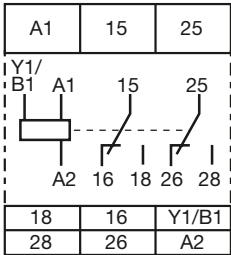

CT-MFD.12

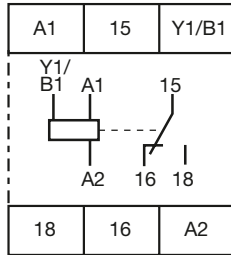

 **CT-ERD.22**

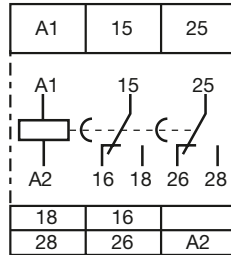

 **CT-ERD.12**

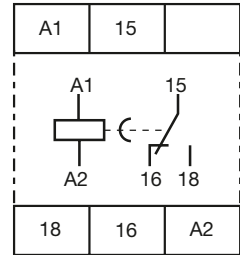

 **CT-AHD.22**

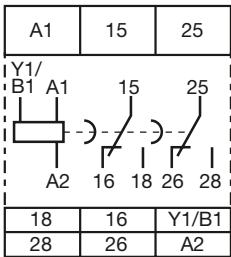

 **CT-AHD.12**

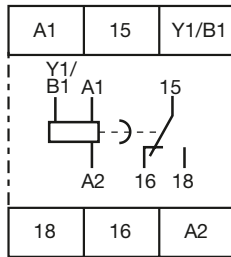

 **CT-VVD.12**

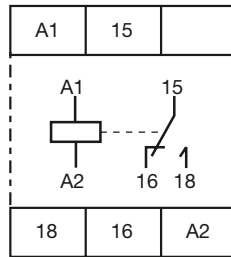

 **CT-EBD.12**

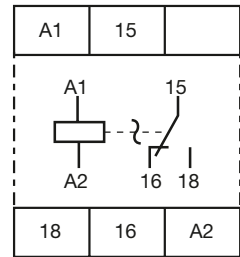

 **CT-TGD.22**

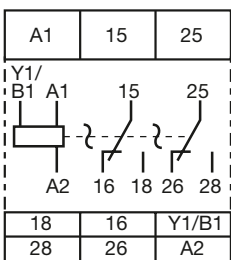

 **CT-TGD.12**

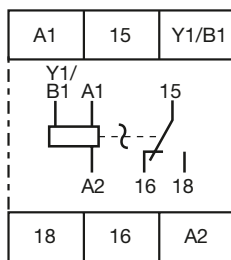

 **CT-SDD.22**

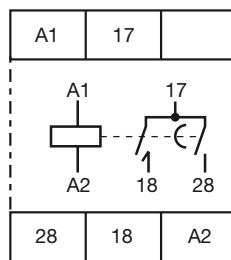

 **CT-SAD.22**

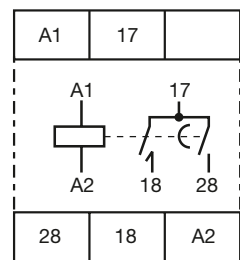

E 234

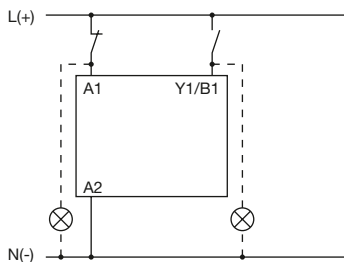

Wiring notes for devices with control input
A parallel load to the control input is possible

Quick product references

Control and automation wiring diagrams

TL1

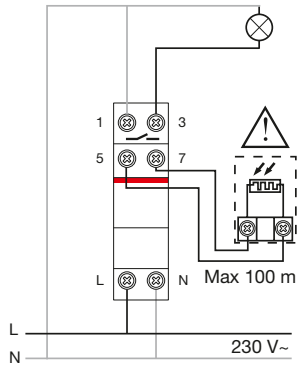

TL1 Pole

230 V~ -30T60
 — 16 (3)A / 250 V~

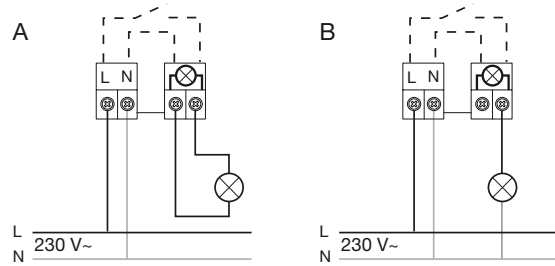

E 450

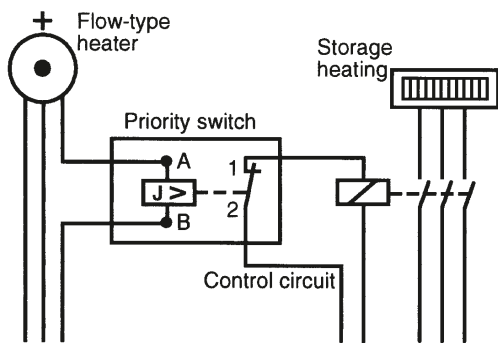

E 235



Quick product references

Energy efficiency wiring diagrams

M2M measurement input and auxiliary power supply connections

Three-phase + neutral with 3 CT

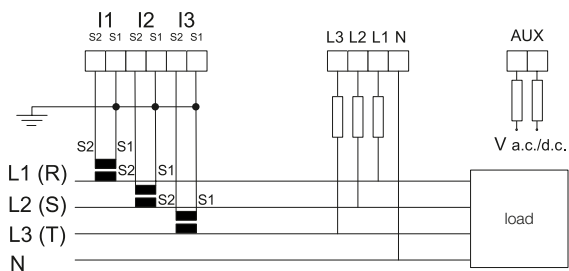

Three-phase with 3 CT

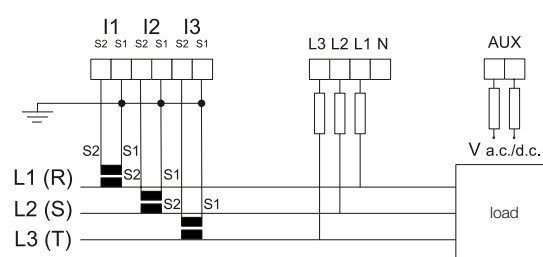

Three-phase + neutral with 3 CT and 3 VT

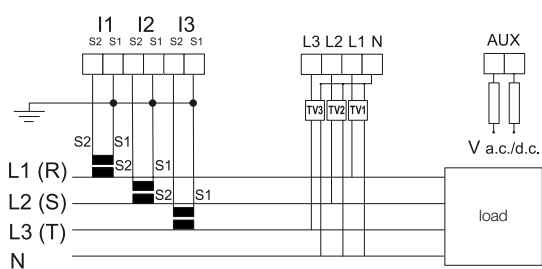

ARON Three-phase with 2 CT and 2 VT

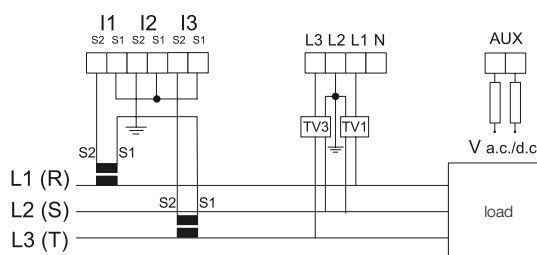

Not suitable for the M2M LV and M2M LV MODBUS models.

Single-phase with 1 CT

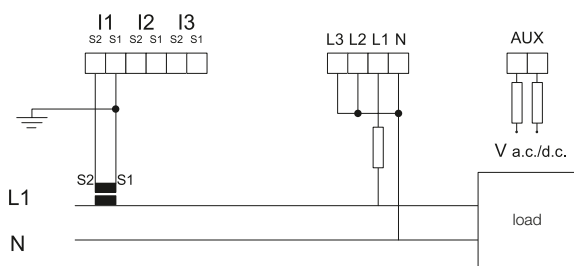

Balanced three-phase with 1 CT

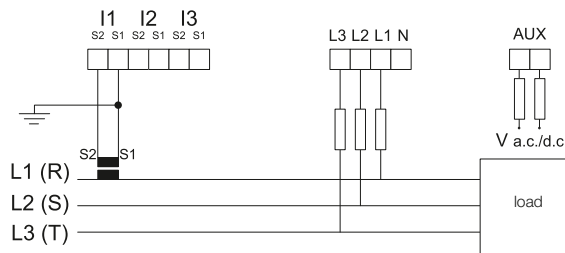

Quick product references

Energy efficiency wiring diagrams

M2M Analogue and digital output connections, digital inputs

Digital outputs as alarms with external relay for control of loads

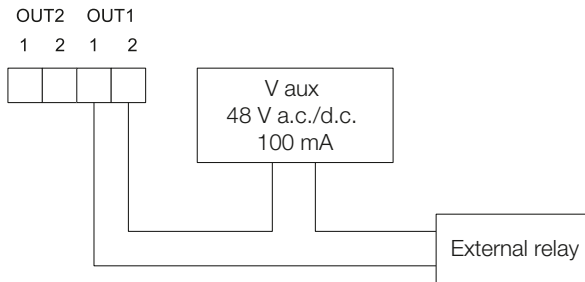

Digital outputs as pulses

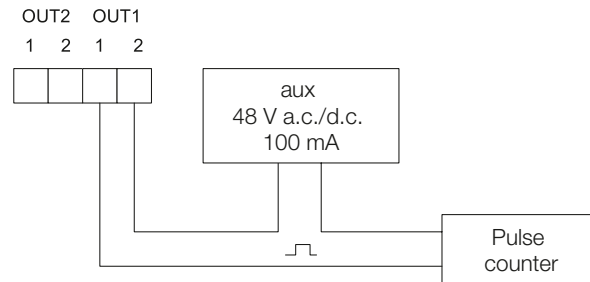

M2M ALARM electromechanical relay outputs

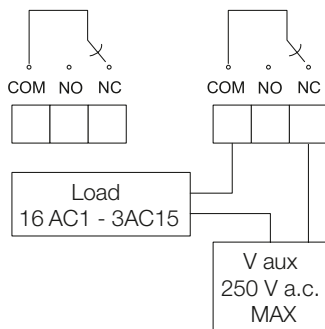

M2M I/O digital inputs (example in NPN mode)

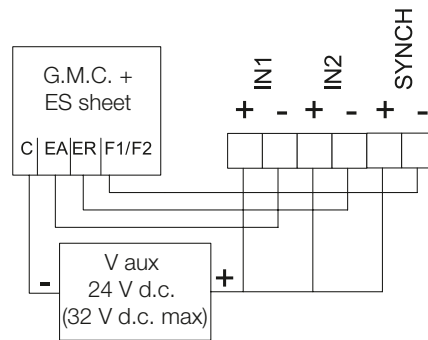

M2M I/O analogue outputs

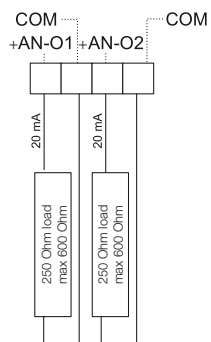

Quick product references

Energy efficiency wiring diagrams

ANR

4 wires insertion

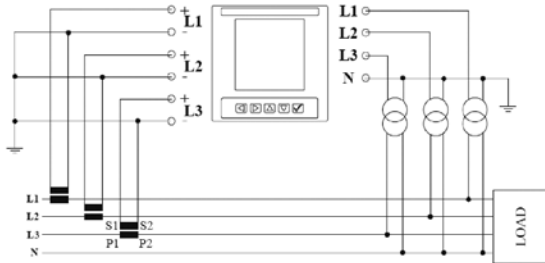

Insertion with 3 CTs and 3 VTs

3 wires insertion

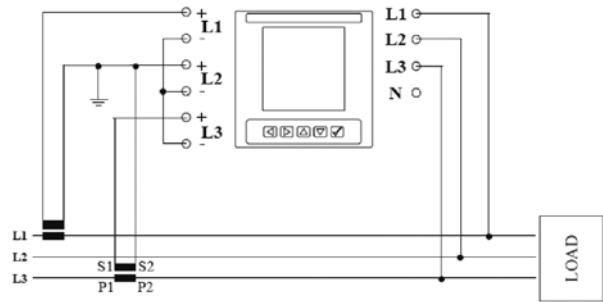

Insertion with 2 CTs

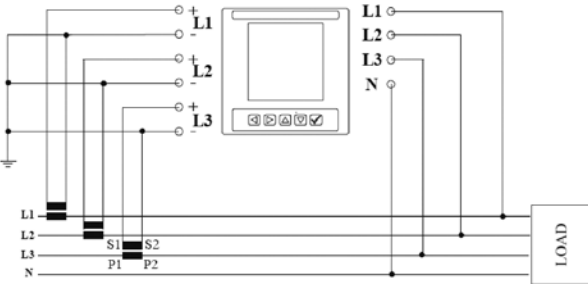

Insertion with 3 CTs

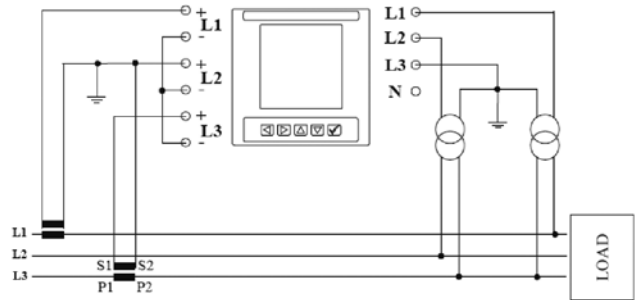

Insertion with 2 CTs and 2 VTs (Aron)

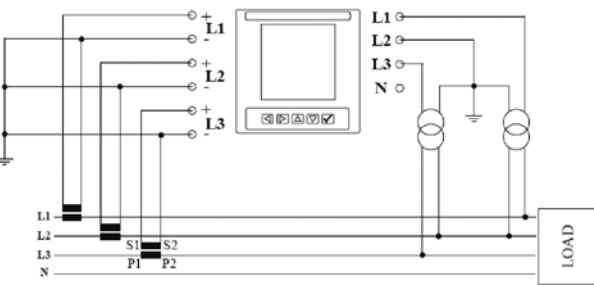

Insertion with 3 CTs and 2 VTs

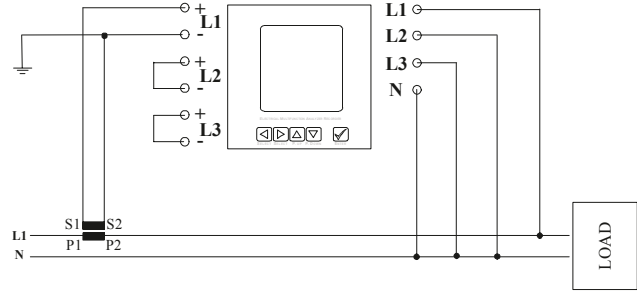

Single phase insertion with 1CT

Quick product references

Energy efficiency wiring diagrams

DMTME

Three-phase with neutral and 3 CTs

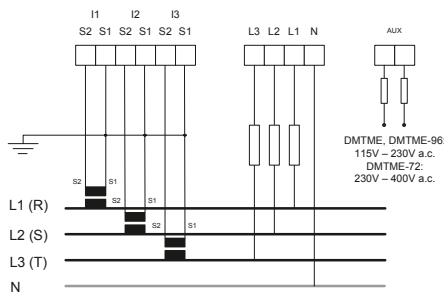

Three-phase with 3 CTs

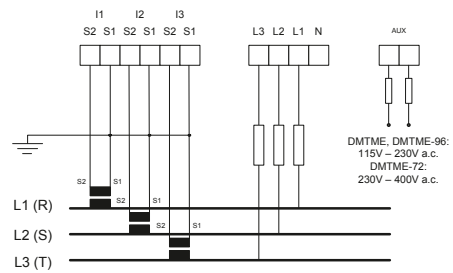

Three-phase with neutral and 3 CTs and 3 VTs
Up to 500 V phase-neutral a direct connection is possible

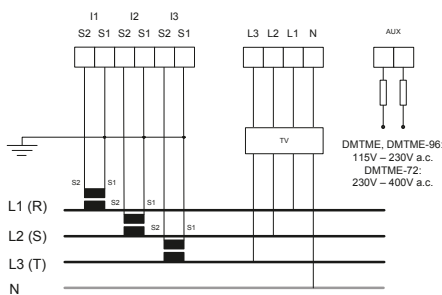

Aron type three-phase with 2 CTs and 2 VTs
With symmetric and unbalanced network, 3 CTs and up to 800 V, beyond this value must use VT.

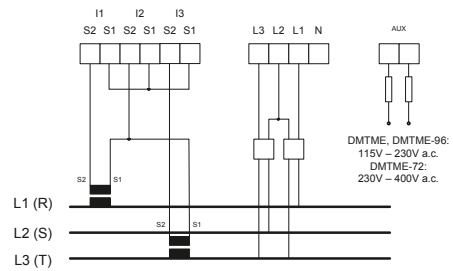

Digital output used as alarm with external relays for load command

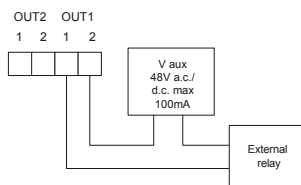

Single phase with neutral and 1 CTs

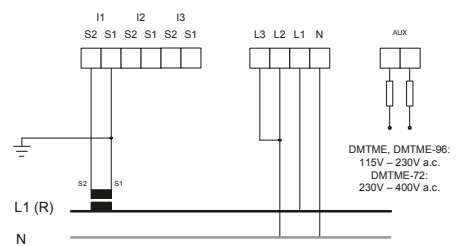

Digital output used as pulses

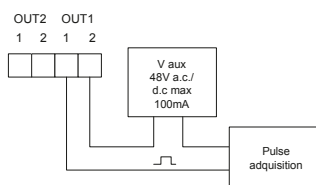

Quick product references

Energy efficiency wiring diagrams

CUS

CUS RS485/232

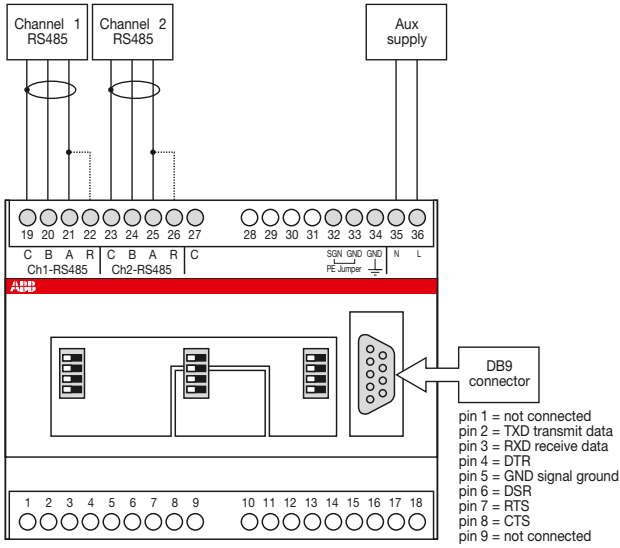

CUS 485 TCP/IP

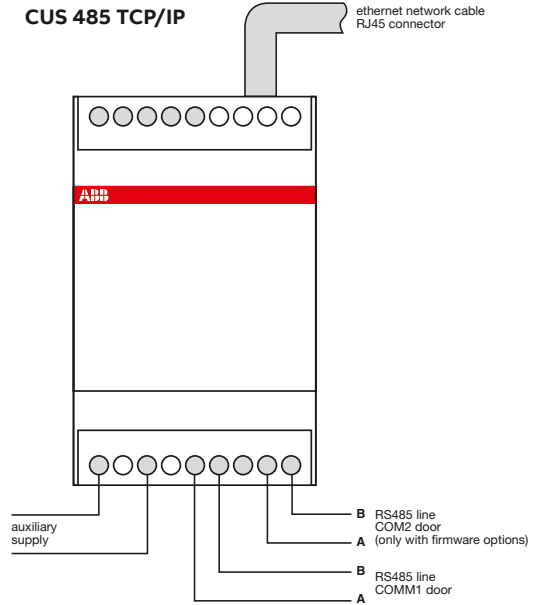

A series A41

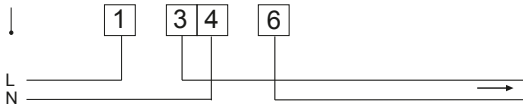

A series A42

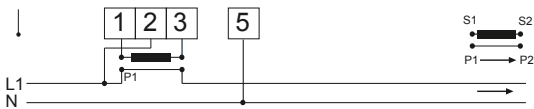

A series A43

3 wire connection, 2 elements

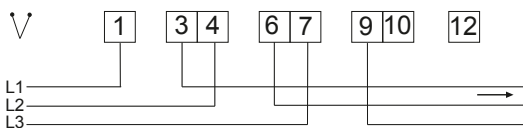

4 wire connection, 3 elements

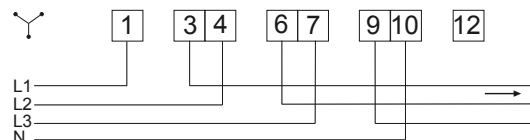

Quick product references

Energy efficiency wiring diagrams

A series A44

3 wire connection, 2 elements

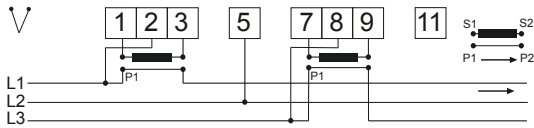

4 wire connection, 3 elements

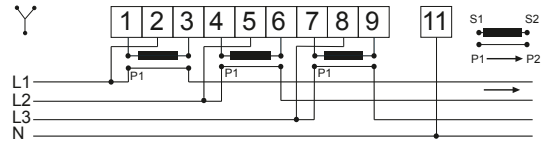

B series B21

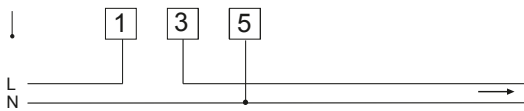

B series B23

3 wire connection, 2 elements

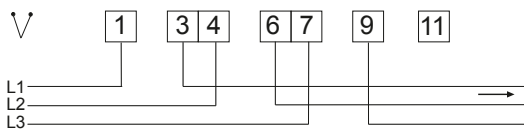

4 wire connection, 3 elements

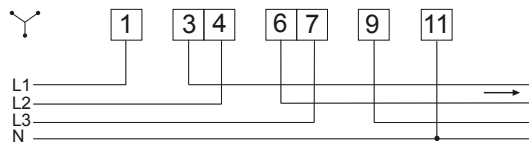

B series B24

3 wire connection, 2 elements

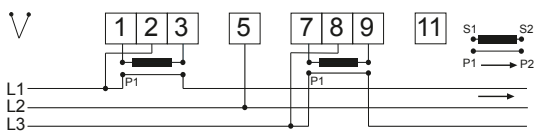

4 wire connection, 3 elements

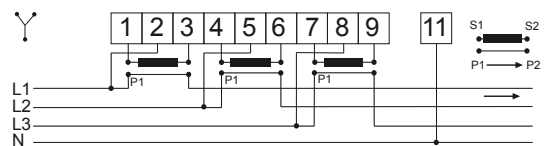

C series C11

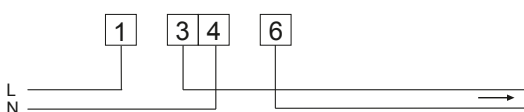

C series C13

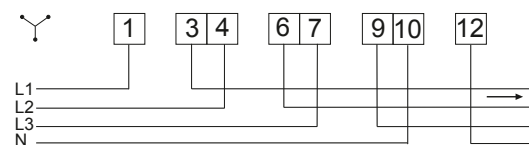

Quick product references

Energy efficiency wiring diagrams

Digital instruments

VLMD-1-2 and VLMD-1-2-R VLMD P and VLMD-R P

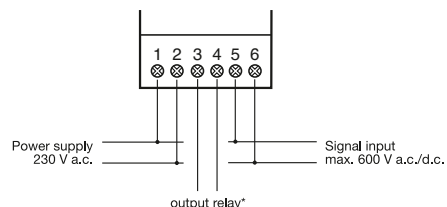

FRZ-DIG

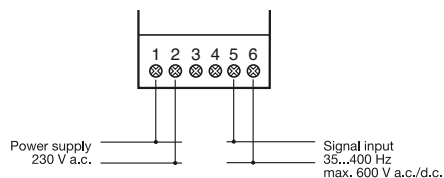

AMTD-1 and AMTD-1-R AMTD-1 P and AMTD-1-R P

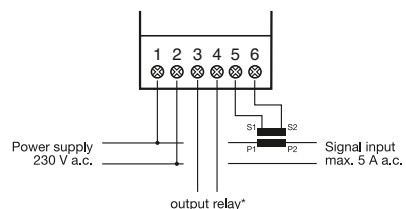

AMTD-2 and AMTD-2-R AMTD-2 P and AMTD-2-R P

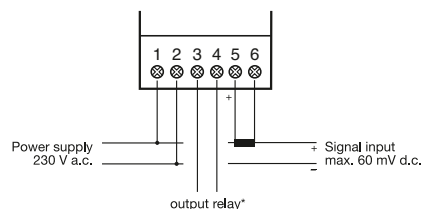

*Only for instruments with output relay

Analogue instruments

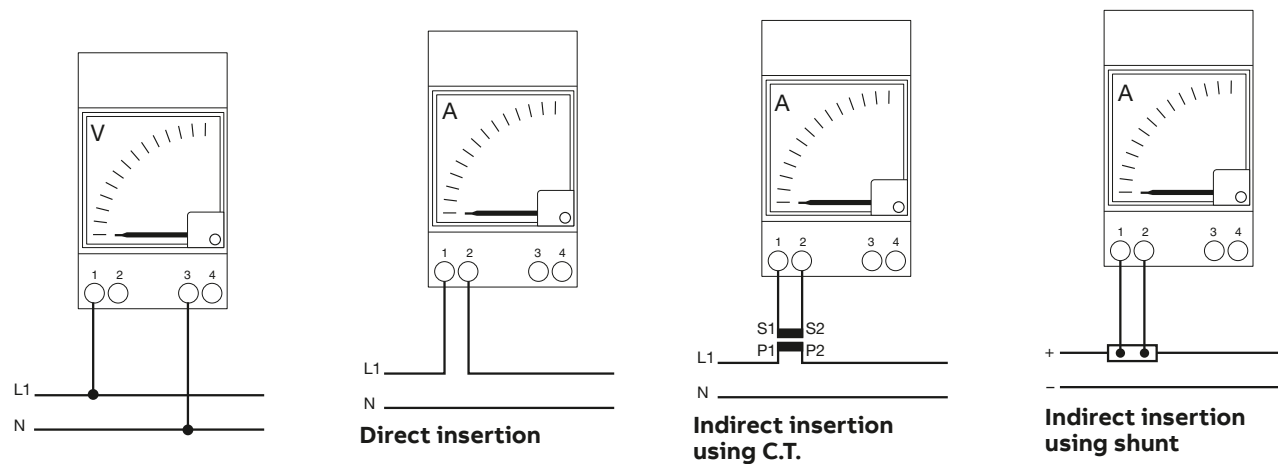

Quick product references

Energy efficiency wiring diagrams

Front panel analogue instruments

Voltmeter for alternating current

Direct insertion

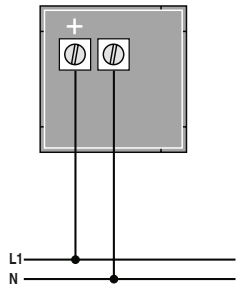

Insertion via VT

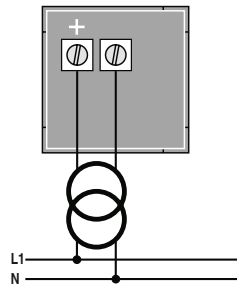

Voltmeter for direct current

Direct insertion

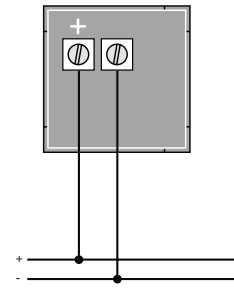

Ammeter for alternating current

Direct insertion

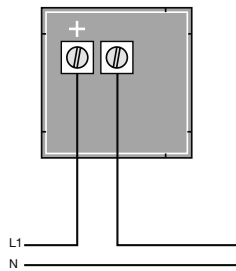

Insertion via CT

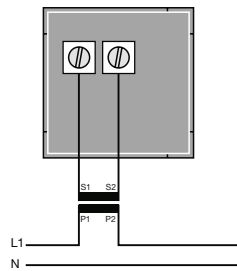

Ammeter for direct current

Direct insertion

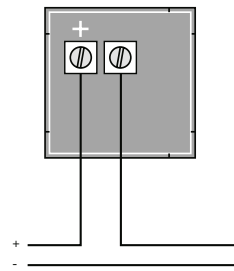

Insertion with Shunt

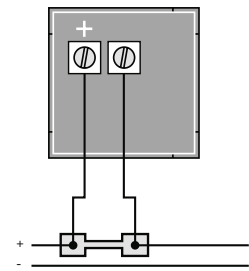

MCV, MCA, QCV and QCA

MCV4

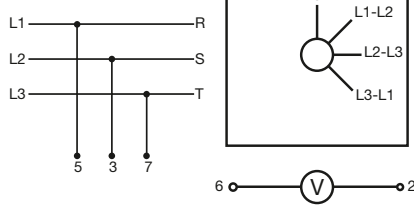

MCA4

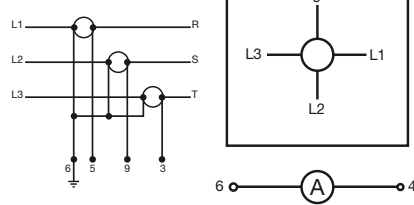

MCV7

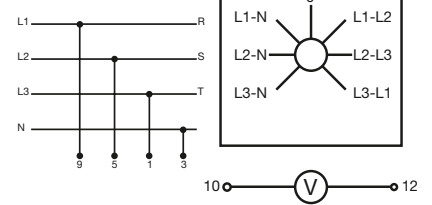

QCV-4

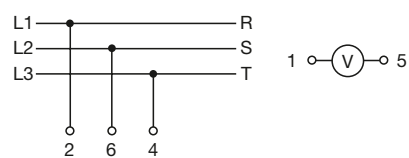

QCA-4

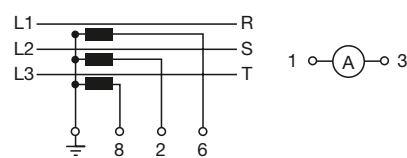

QCV-7

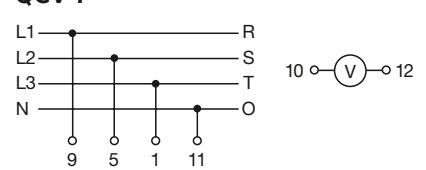

Quick product references

Energy efficiency wiring diagrams

E 233

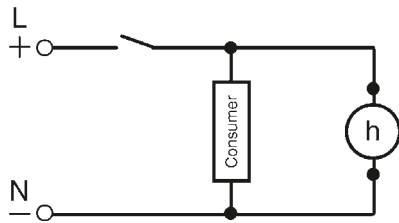

elapsed-time meter



E 233-15/48 DC

HMT

HMT 1

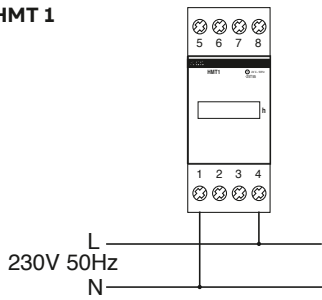

HMT 11

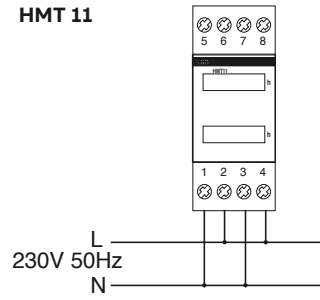

SNT

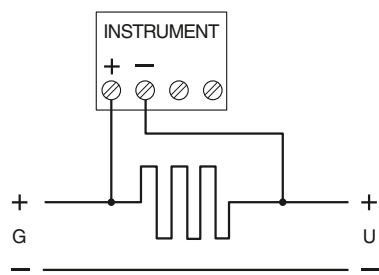

Quick product references

Overall dimensions

Modular products	Width		Depth		Max. dimensions	
	modules	mm	DIN-rail to door	DIN-rail to front	max depth	max height
Miniature circuit breakers						
S 301	1	17.5	44	-	69	88
S 301 Na	2	35				
S 302	2	35				
S 303	3	52.5				
S 303 Na	4	70				
S 304	4	70				
S 300 with bottom aux. cont.	See drawings					
S 201 S	1	17.5	44	-	69	89
S 203 S	3	52.5	44	-	71	92
S 201 U	1	17.5				
S 202 U	2	35				
S 203 U	3	52.5				
S 204 U	4	70				
S 201 UDC	1	17.5	44	-	71	92
S 202 UDC	2	35				
S 203 UDC	3	52.5				
S 204 UDC	4	70				
SU 201 M	1	17.5	49.5	-	69	111
SU 202 M	2	35				
SU 203 M	3	52.5				
SU 204 M	4	70				
SN 201	1	17.6	43.5	58	68.9	91.8
S 201 80-100A	1	17.5	44	58	69	88.8
S 202 80-100A	2	35				
S 203 80-100A	3	52.5				
S 204 80-100A	4	70				
S750DR	See drawings					
S 801	1.5	26.5	52	82.5	88.5	95
S 802	3	53				
S 803	4.5	79.5				
S 804	6	106				
S 801_-R	1.5	26.5	52	82.5	88.5	142
S 802_-R	3	53				
S 803_-R	4.5	79.5				
S 804_-R	6	106				

Quick product references

Overall dimensions

Modular products	Width		Depth		Max. dimensions	
	modules	mm	DIN-rail to door	DIN-rail to front	max depth	max height
Residual current devices						
F 202	2	35	44	-	69	88
F 204	4	70				
F 202 B	2	35	44	-	69	85
F 204 B	4	70				
F 204 B high ratings	4	72	44	60	69.5	85
F 204 125 A	2	72	44	60	69.5	-
DDA 200	See drawings					
DS 202 up to 40 A	4	70	44	-	69	93
DS 203 up to 40 A	5	87.5				
DS 204 up to 40 A	6	105				
DS 202 50, 63 A	4	70	44	-	69	93
DS 203 50, 63 A	7	122.5				
DS 204 50, 63 A	8	140				
DS201	2	35	44	58	69	85
DS202CR	2	35.8	44	59.2	69.4	98
DS301C	1	17.6	50.3	67	74	85
DS203NC	4	70.4	-	-	69	85
DSE201 - DSE201 M	1	17.5	-	-	69	100 - 115
DDA 800	See drawings					
RD2	2	35	44	58	-	85
RD3	3.5	58.2	44.2	57.9	57.9	85
ELR	See drawings					
Toroidal transformers	See drawings					
AFDD						
S-ARC1	2	35	-	-	69	85
Auxiliary elements and accessories						
S 2C-A_	1	17.5	44	-	69	85
S 2C-H11L	0.5	8.8				
S 2C-H20L						
S 2C-H02L						
S 2C-S/H 6R						
S 2C-H 6R						
S 2C-UA_			1	17.4	44	-
F 2C-A_						
S 2C-OVP						
F 2C 125A-SH/S2C-Nt	0.5	8.8	44	-	70	88
Bottom fixing aux. cont.	See drawings					
S 2C-EST	See drawings					
S 2C-BP	1	17.5	44	-	68	85

Quick product references

Overall dimensions

Modular products	Width		Depth		Max. dimensions	
	modules	mm	DIN-rail to door	DIN-rail to front	max depth	max height
S 2C-CM	See drawings					
F 2C-ARI	See drawings					
F 2C-CM	See drawings					
F 2C-ARH	See drawings					
F 2C-ARH-T	See drawings					
Aux. elements for SN201	See drawings					
Aux. elements for S280 and S290	0.5	8.75	44	-	73	90
	1	17.5				
S800-AUX	See drawings					
S800-RSU-H	See drawings					
S800-RD+S800-RHE	See drawings					
Terminal covers	See drawings					
Enclosures	See drawings					
Flush frame	See drawings					
Busbars	See drawings					
Me flange	See drawings					
OH_2A_	See drawings					
Protection and safety						
Type 1+2 12.5kA (440V) SPD 1 pole /(TS)	2	36	52	58	76,7	108.1/(109.2)
Type 1+2 12.5kA (440V) SPD 2 poles /(TS)	4	72				
Type 1+2 12.5kA (440V) SPD 3 poles /(TS)	6	108				
Type 1+2 12.5kA-440V SPD 4 poles	8	144				
Type 1+2 12.5kA 275V, Type 2 (RES) or Type 2+3 SPD 1 poles /(TS)	1	17.8	43,5	69,4	76,7	88/(95)
Type 1+2 12.5kA 275V, Type 2 (RES) or Type 2+3 SPD 2 poles	2	36				
Type 1+2 12.5kA 275V, Type 2 (RES) or Type 2+3 3 poles /(TS)	3	54				
Type 1+2 12.5kA 275V, Type 2 (RES) or Type 2+3 4 poles /(TS)	4	71.2				
E90 20/32 and PV (1000 VDC) 1 pole	1	17.5	-	-	64	85
E90 20/32 1 pole + N	2	35				
E90 20/32 and PV (1000 VDC) 2 poles	2	35				
E90 20/32 3 poles	3	52.5				
E90 20/32 3 poles + N	4	70				
E90 20/32 4 poles	4	70				

Quick product references

Overall dimensions

Modular products	Width		Depth		Max. dimensions	
	modules	mm	DIN-rail to door	DIN-rail to front	max depth	max height
E90/32 PV 1500						
E90 50 1 pole						
E90 50 1 pole + N						
E90 50 2 poles						
E90 50 3 poles						
E90 50 3 poles + N						
E90 125 1 pole						
E90 125 1 pole + N						
E90 125 2 poles						
E90 125 3 poles						
E90 125 3 poles + N						
E90 30 Class J 1 pole						
E90 30 Class J 2 poles						
E90 30 Class J 3 poles						
E90 60 Class J 1 pole						
E90 60 Class J 2 poles						
E90 60 Class J 3 poles						
ILTS-E 1 pole	1.5	27				
ILTS-E 2 poles	3	54	44	70	70	90
ILTS-E 3 poles	4.5	81				
ILTS-E 4 poles	6	108				
SQZ3	3	52.5	44	58	58	85
E 236 US1	2	35	44	60	65	87
E 236 US2						
E 236 US1.1						
E 236 US2.1	1	17.5	44	60	60	87
E 236 US1.1D						
Isoltester-DIG	6	105	44	56	61	90
Selvtester-24	3	52.5	44	58	58	85.5
QSD						
TI						
QSO						
ISL-A 115						
ISL-A 230						
ISL-A 600	6	105	44	58	65	90
ISL-C 600						
ISL-A 24-28						
ISL-C 230						
ISL-C 440	3	52.5	44	58	65	85.5
ISL-MOT 1000						

Quick product references

Overall dimensions

Modular products	Width		Depth		Max. dimensions	
	modules	mm	DIN-rail to door	DIN-rail to front	max depth	max height
Command and signaling						
E201	1	17.5	44	58	70	85
E202	2	35				
E203	3	52.5				
E204	4	70				
SD201	1	17.5	44	58	69	85
SD202	2	35				
SD203	3	52.5				
SD204	4	70				
SHD201	1	17.5	44	58	69	88
SHD202	2	35				
SHD203	3	52.5				
SHD204	4	70				
E463	2.5	44	44	58	70	85
E210	0.5	9	43.5	58	67.9	85
E210	1	18				
ESB 20	1	17.5	44	58	58	85
ESB 24	2	35				
ESB 40	3	54				
ESB 63						
EN 20	1	17.5	44	58	58	85
EN 24	2	35				
EN 40	3	54				
EN 63						
E290	See drawings					

Quick product references

Overall dimensions

Modular products	Width		Depth		Max. dimensions	
	modules	mm	DIN-rail to door	DIN-rail to front	max depth	max height
STD	See drawings					
E 234 1 contact	1	17.5	43.4	58	58	70
E 234 2 contacts						80
TS 25 C	4	70	44	58	58	85
TS 40 C	4	70				
TS 63 C	5	87.5				
TM10	2	35	44	58	58	85
TM15						
TS8...16						
TM30	3	52.5	44	58	58	85
TM40						
TS24						
SM	1	17.5	44	58	58	85
RM						
TSM	2	35	44	58	58	85
TSR						
CP-D 15/0.83	1	18	44	58	58	91
CP-D 24/0.42						
CP-D 24/2.5	4	71	44	58	58	91
CP-D 15/2.1						
CP-D 24/1.3	3	53	44	58	58	91
CP-D 24/4.2						
CP-D 24/4.2	5	89.9				
TM- M117_ M1011 M1363	See drawings					
M117_	2.5	44	44	60	60	85
M1011	3	53				
M1363						
MA1-8001						

Quick product references

Overall dimensions

Modular products	Width		Depth		Max. dimensions	
	modules	mm	DIN-rail to door	DIN-rail to front	max depth	max height
Control and automation						
AT1e	1	17.8				
AT1e-R						
AT2, AT2e	2	35	44	60	60	88.5
AT2-R, AT2e-R						
AT2-7R, AT2e-7R						
AT72e	See drawings					
D Line	2	35	43.8	60	60	90
E 232-230	1	17.5	44	59	59	88
E 232 E					58	90
TWA-1	2	35.8	43.8	60	60	85
TWA-2						
T1, T1 PLUS	1	17.5	-	-	65	86
E 450	1	17.5	-	60	60	85
LSS1/2	5	87.5	-	58	58	85
E 235	1	17.5	-	58	58	85

Quick product references

Overall dimensions

Modular products	Width		Depth		Max. dimensions	
	modules	mm	DIN-rail to door	DIN-rail to front	max depth	max height
Energy efficiency						
Modular analogue measurement instruments	3	52.5	44	58	58	85
Modular digital measurement instruments	3	52.2	44	58	58	85
MCV, MCA	See drawings					
QCV, QCA	See drawings					
DMTME	6	105	44	58	58	90
CUS	6	105	44	58	58	90
CUS 485	3	52.5				
TRF M	3	52.5	44	58	58	85.5
TV2	See drawings					
Shunts	See drawings					
E 233	1	17.5	44	58	58	85
HMT	2	35	44	58	58	85
A41	4	70				
A42						
A43	7	123				
A44						97
B21	2	35	44	65	65	
B23	4	70				
B24						
C11	1	17.5				111
C13	3	54				122

Quick product references

Overall dimensions

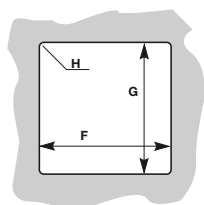
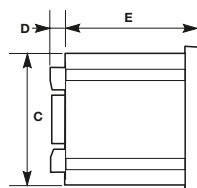
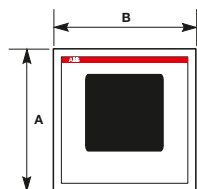

Product without modular profile	A [mm]	B [mm]	C [mm]	D [mm]	E [mm]	F [mm]	G [mm]	H
Front panel devices								
SL - 48	48	48	44	7	48	45	45	R3
SL - 72	144	72	-	9	55	67	137	R3
Analogue measurement instruments - 48	48	48	43	6	53	45±0.1	45±0.1	R3
Analogue measurement instruments - 72	72	72	67	6	53	68±0.7	68±0.7	R3
Analogue measurement instruments - 96	96	96	90	6	53	92±0.8	92±0.8	R3
Digital measurement instruments	36	72	32	6	51.5	68±0.8	33±0.8	R3
M2M	96	96	90	16	61	92	92	R3
ANR 96	96	96	90	14	115	92	92	R3
TMD	96	96	90	14	115	92	92	R3
DMTME - 96	96	96	90	13	90	92	92	R3
DMTME - 72	72	72	-	10	90	68	68	R3

Quick product references

Overall dimensions

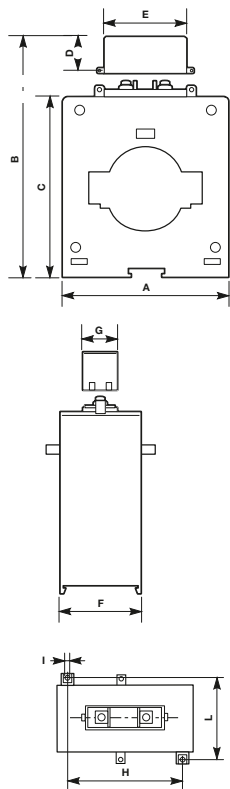

Product without modular profile	A	B	C	D	E	F	G	H	I	L
	[mm]	[mm]	[mm]	[mm]	[mm]	[mm]	[mm]	[mm]	[mm]	[mm]
Measurement current transformers										
CT MAX	see drawings									
CT PRO XT	see drawings									
CTA	see drawings									
CT6	105	121	100	18.5	75	61	21	82	3.7	76.7
CT8	125	142	120	18.5	50	61.5	21	82	3.7	76.7
CT8-V	109	141	119	18.5	50	41	21	-	-	-
CT12 up to 4000 A	180	196	175	18.5	50	68.5	21	156.8	3.7	84
CT12 5000 A, CT12 6000 A	272	290	265	25	50	-	-	-	-	50
CT12-V	109	186	165	18.5	50	41	21	-	-	-
CTO	see drawings									

Quick product references

Overall dimensions

S 200/S 300 with bottom-fitting auxiliary contact

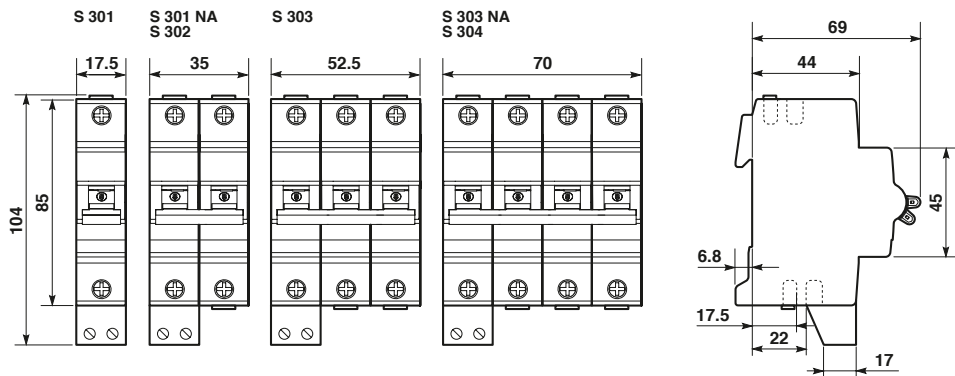

S 750 DR 16...63A

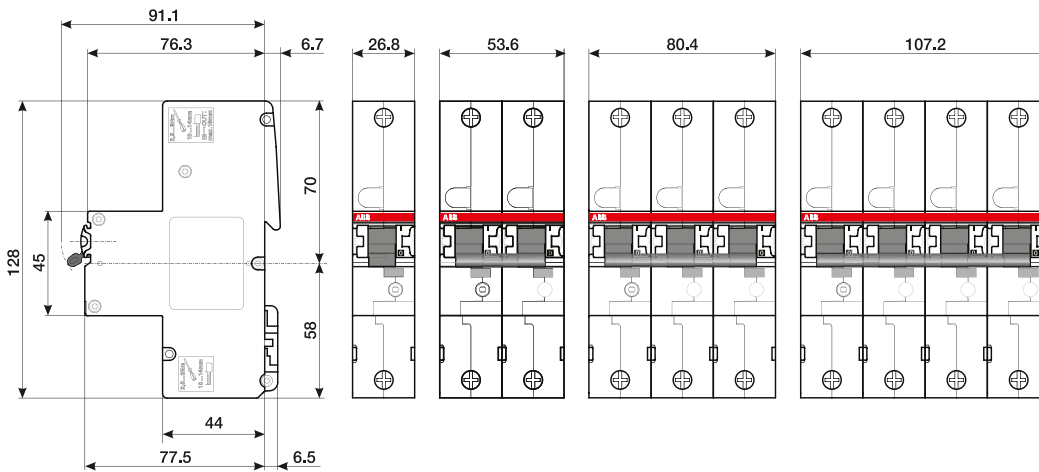

S 750 DR 80...100A

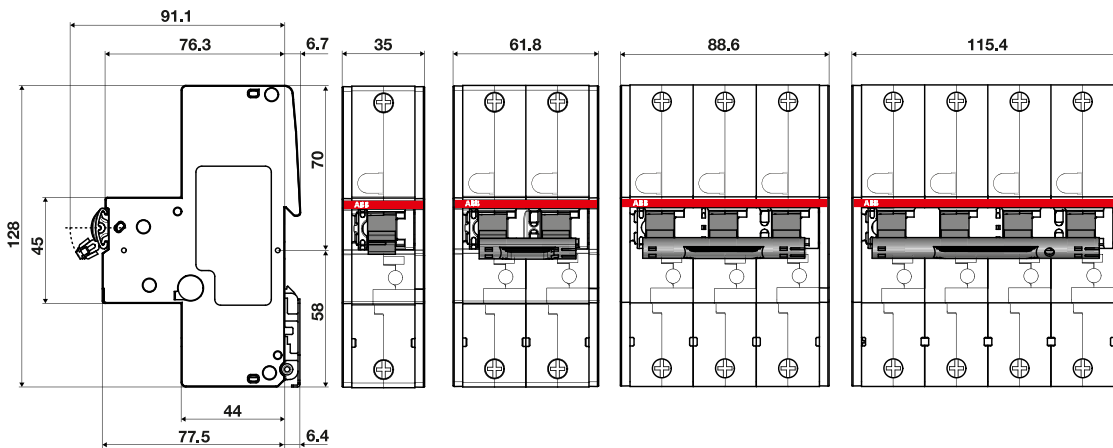

Quick product references

Overall dimensions

S800S, S800N, S800C, S800B, S800U, S800PV-SP, S800PV-SD

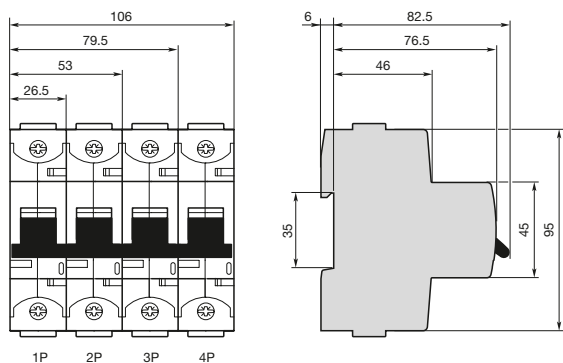

S800 with Ringlug terminals

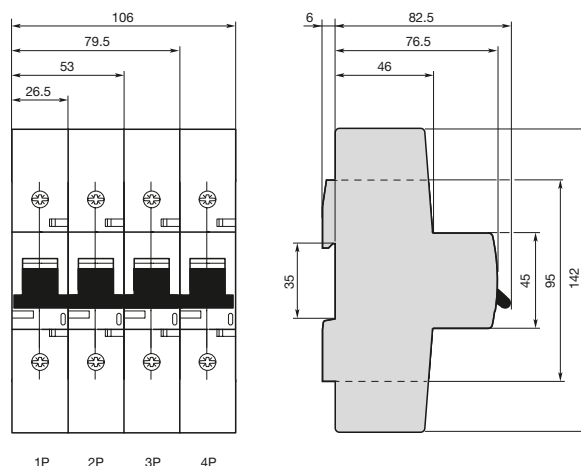

S800 mounting distances

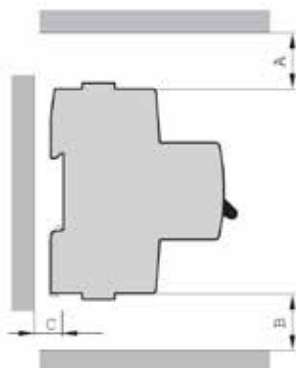

S800S, S800N, S800C

up to 254/440 VAC or 500VDC

S800S-UC

up to 1000 VDC

S800S-SCL-SR

up to 400/690 VAC

Dimensions	isolated parts/surfaces	not isolated parts/surfaces
A	25	100
B	25	25
C	7	50

S800S, S800N, S800C, S800HV

from 254/440 VAC up to 400/690 VAC or 588/1000 VAC (S800HV)

S800B

up to 230/400 VAC or 300 VDC

S800PV-SP

up to 1500 VDC

Dimensions	isolated parts/surfaces	not isolated parts/surfaces
A	25	50
B	25	25
C	7	50

S800HV-SCL-SR

up to 580/1000 Vac

Dimensions	isolated parts/surfaces	not isolated parts/surfaces
A	25	150
B	25	25
C	7	50

Quick product references

Overall dimensions

SN201

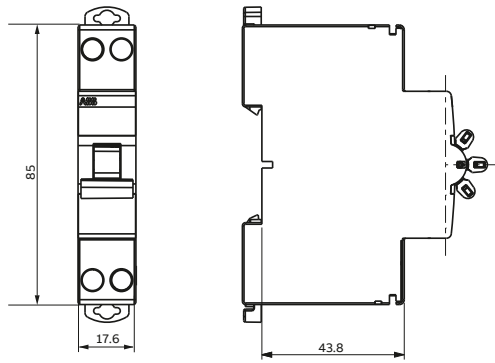

S2011C and S202C

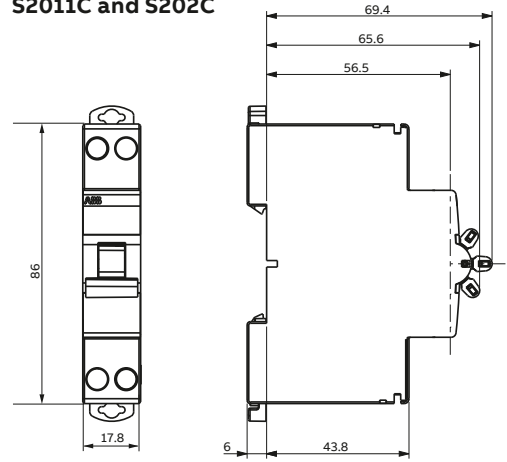

S203C and S204C

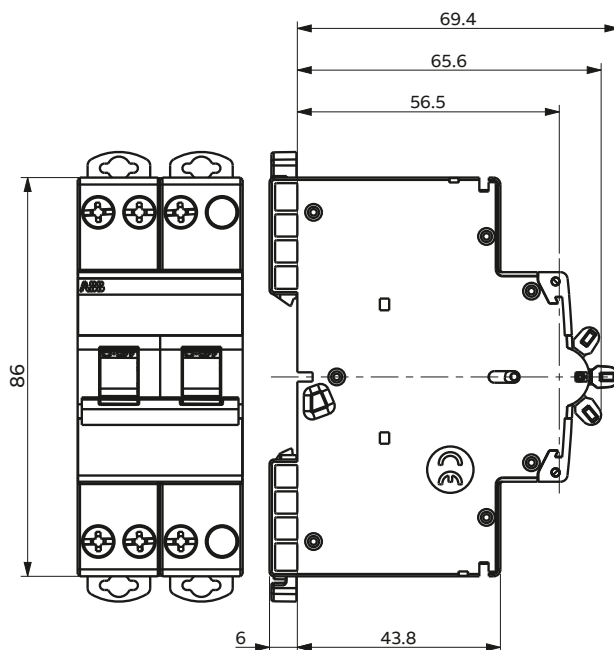

Quick product references

Overall dimensions

S200C Compact MCBs and DS202CR RCBOs - Auxiliary contact

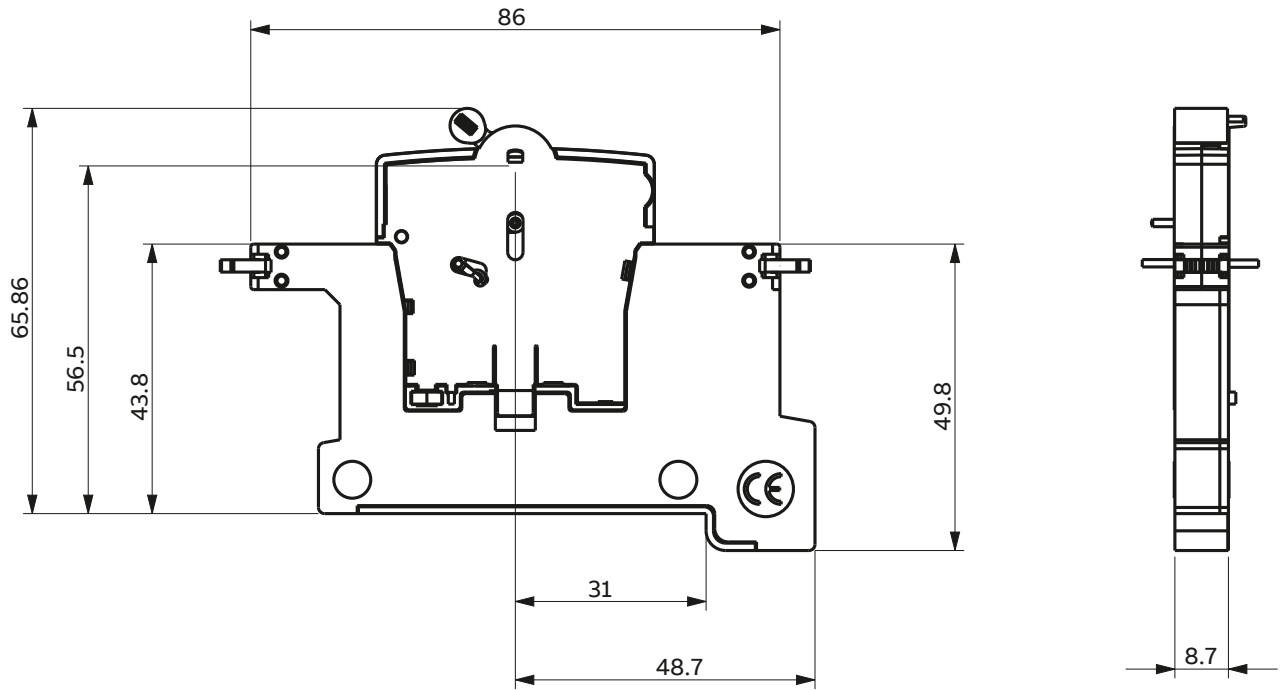

Quick product references

Overall dimensions

DDA 200

In=25-40 A

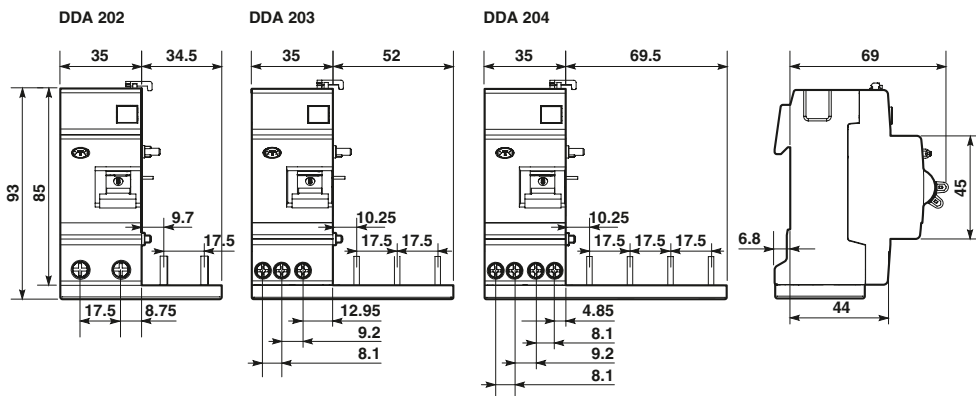

In=63 A

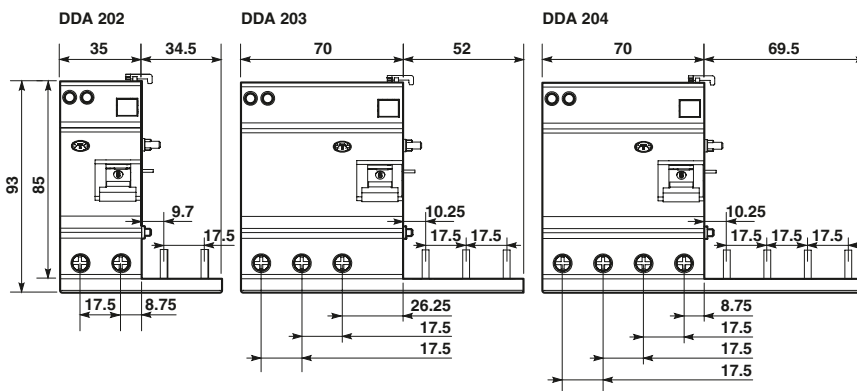

DDA 200 B

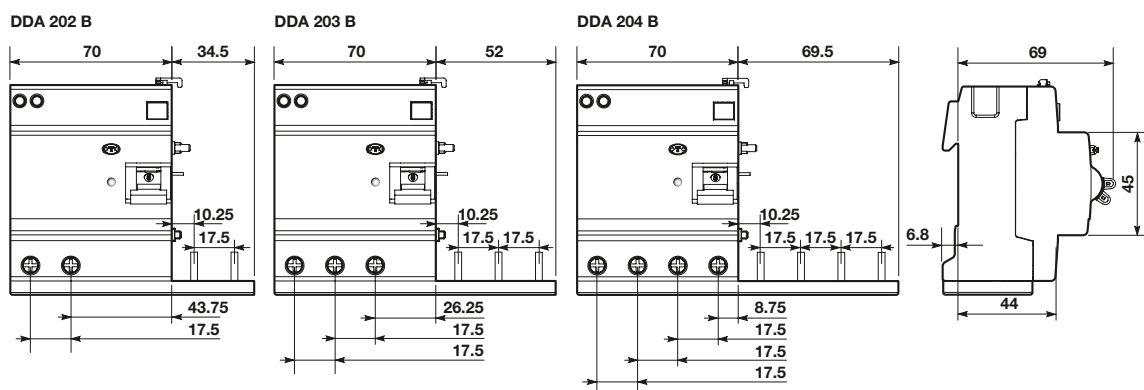

Quick product references

Overall dimensions

DS203NC

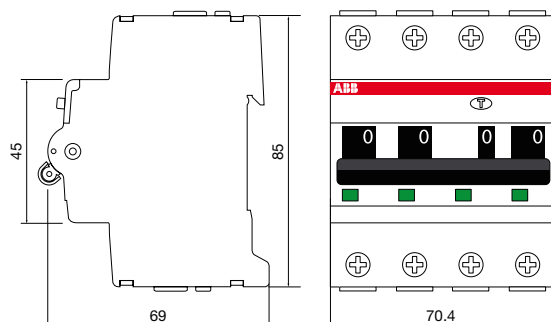

DS201

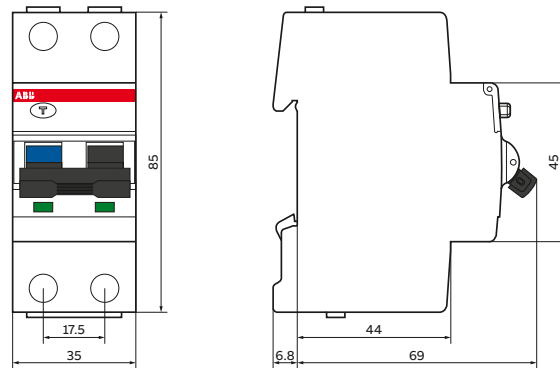

DS301C

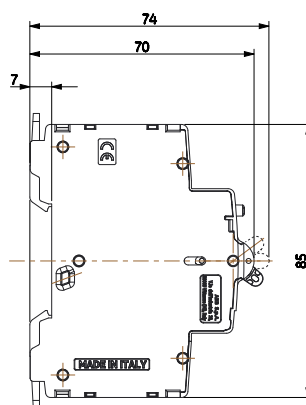
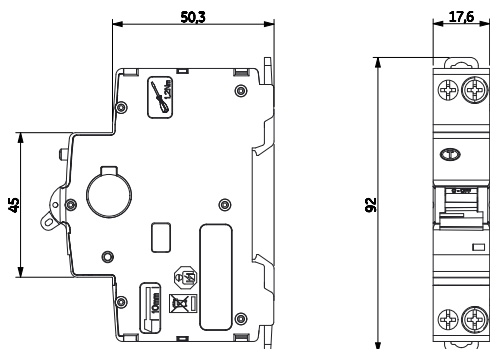

S-ARC1

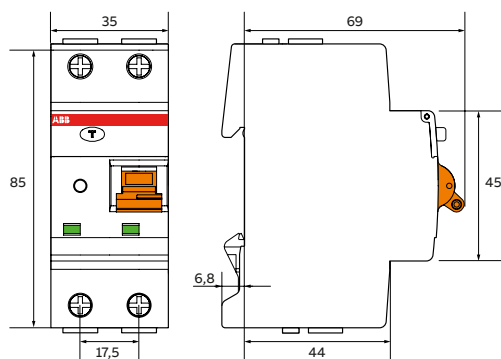

S-ARC1

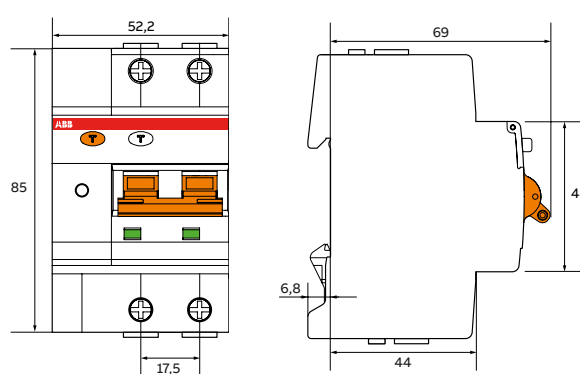

DS202CR

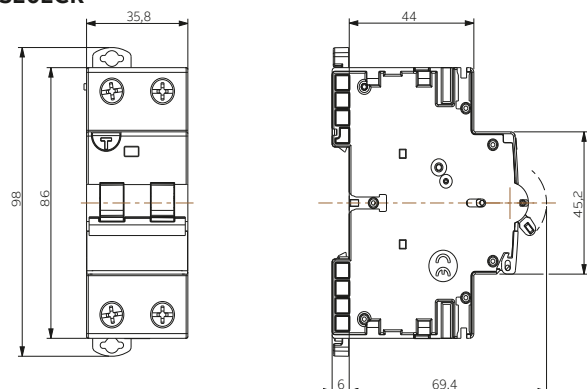

Quick product references

Overall dimensions

DSE201

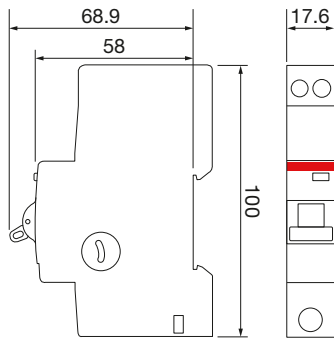

50A version is 115 mm height

DSE201M

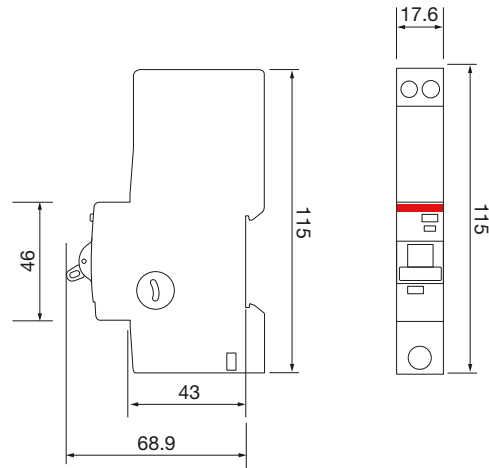

DDA 800 for S800 and DS800 series

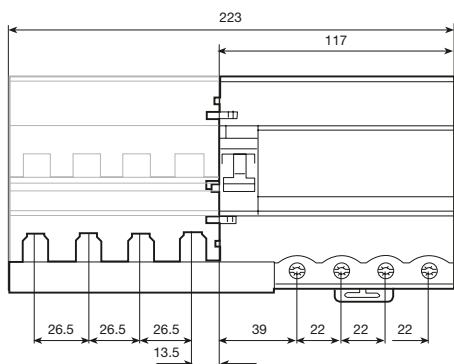
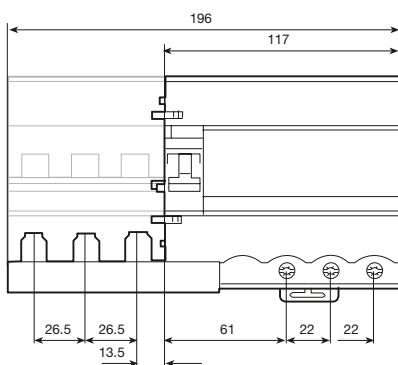
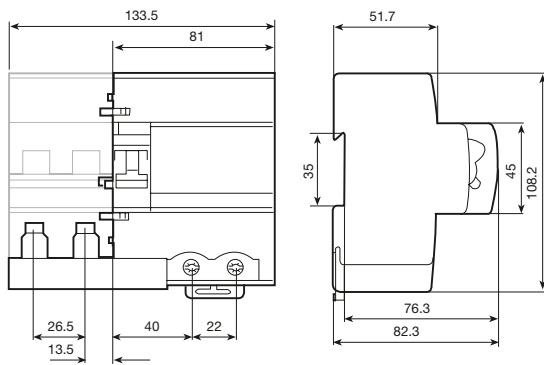

DSE203N M

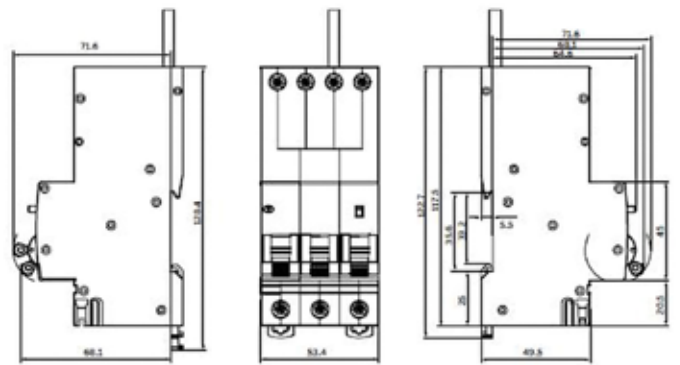

Quick product references

Overall dimensions

ELR front panel residual current relays

ELR48P

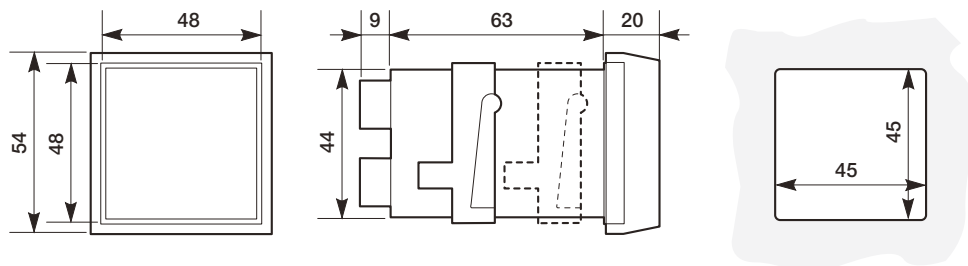

ELR72

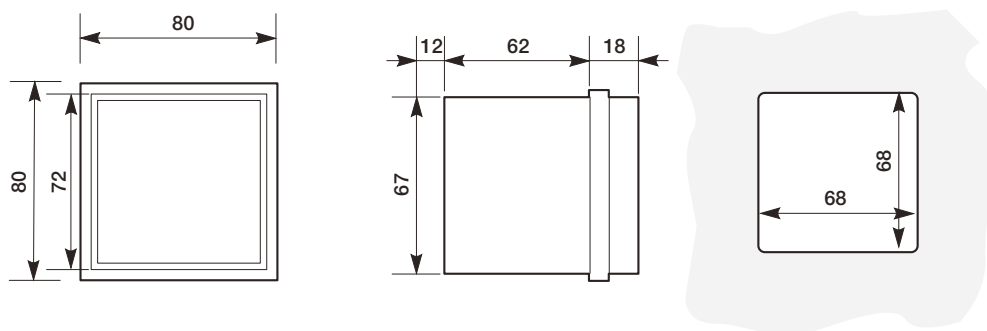

ELR96

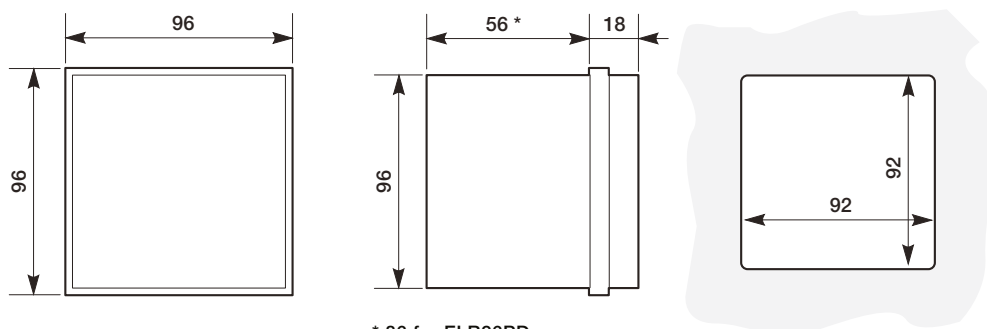

* 86 for ELR96PD

Quick product references

Overall dimensions

Toroidal transformers

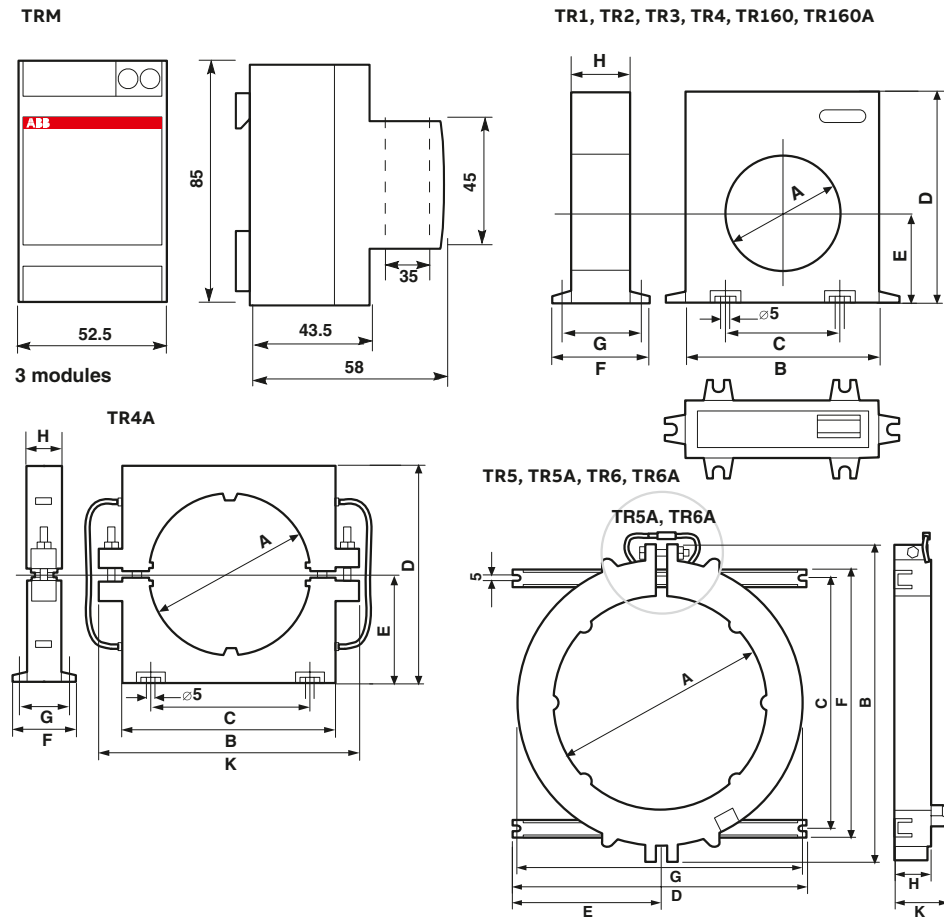

Type	Dimensions (mm)								
	A	B	C	D	E	F	G	H	K
TR1	35	100	60	110	47	50	43	30	-
TR2	60	100	60	110	47	50	43	30	-
TR3	80	150	110	160	70	50	43	30	-
TR4	110	150	110	160	70	50	43	30	-
TR4A	110	145	110	150	75	45	38	25	180
TR160	160	220	156	236	110	64	50	34	-
TR160A	160	220	156	236	110	64	50	34	-
TR5	210	310	240	290	145	260	280	36	55
TR5A	210	310	240	290	145	260	280	36	55
TR6	300	416	350	386	193	366	365	42	60
TR6A	300	416	350	386	193	366	365	42	60

Quick product references

Overall dimensions

Bottom-fitting auxiliary contact (with S 200 MCB)

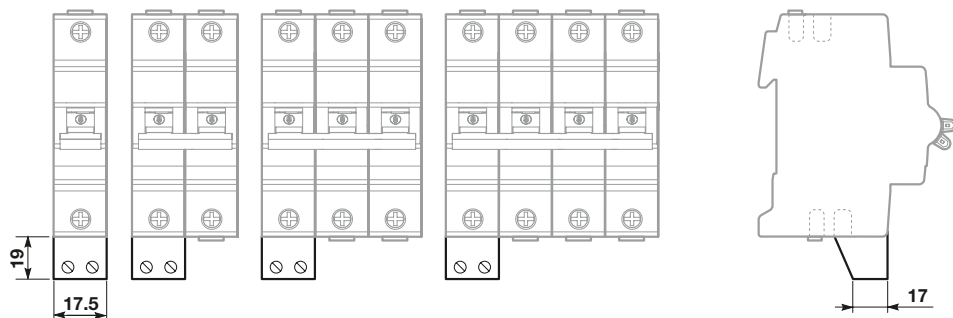

S 2C-EST

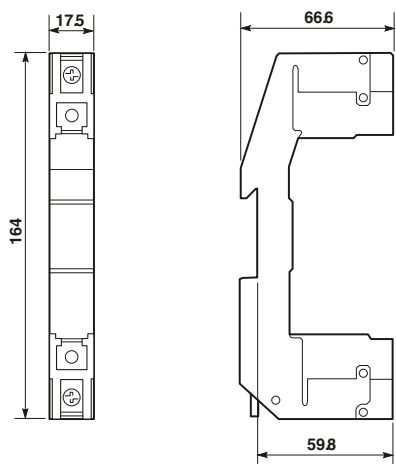

S 2C-CM

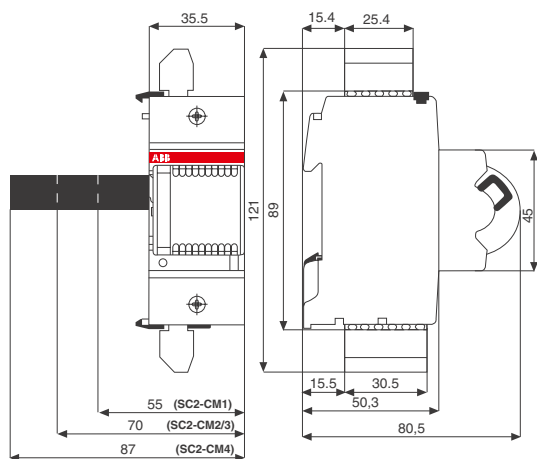

Quick product references

Overall dimensions

F2C-ARI, F2C-CM

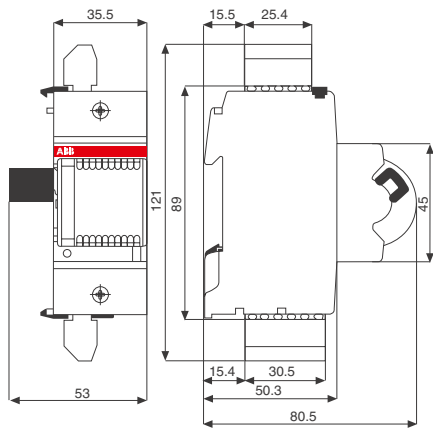

F2 CM4

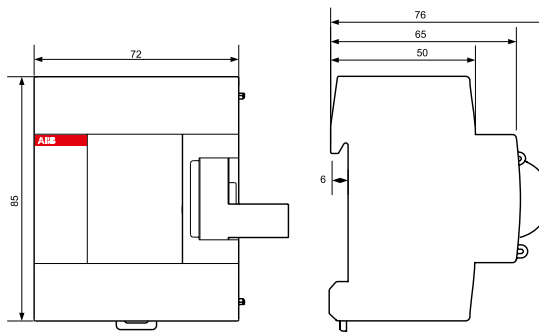

F2C-ARH, F2C-ARH-T

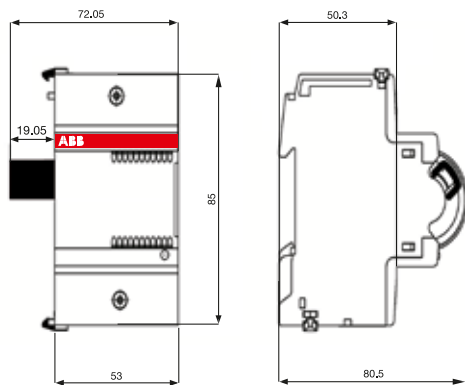

ARBus

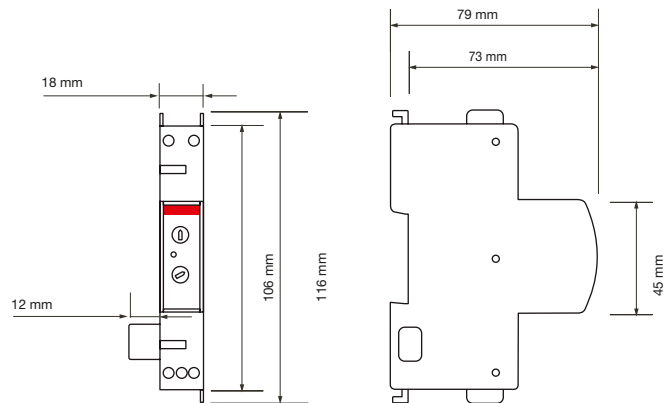

F-ARI Test

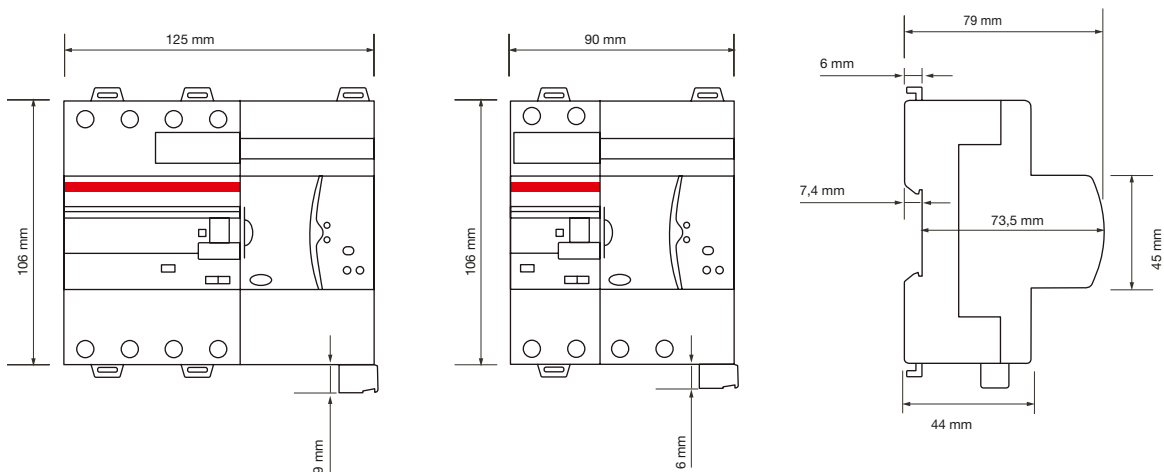

Quick product references

Overall dimensions

Auxiliary elements for SN 201 series

SN201-S

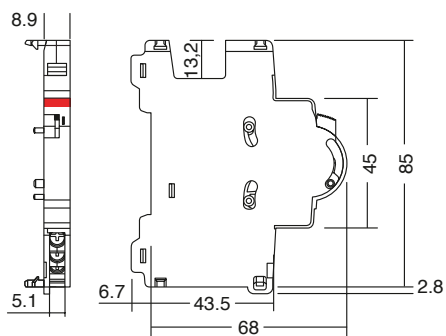

SN201-IH

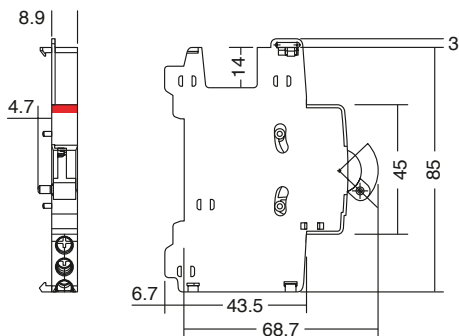

S800-AUX, S800-AUX/ALT

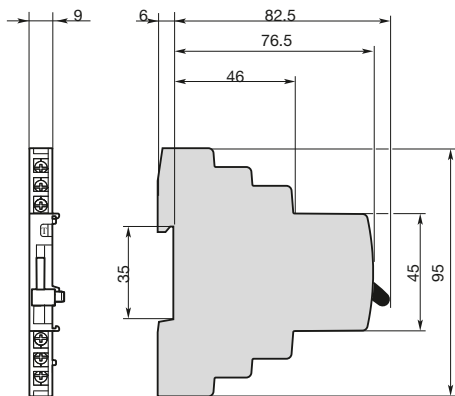

S800-RSU-H

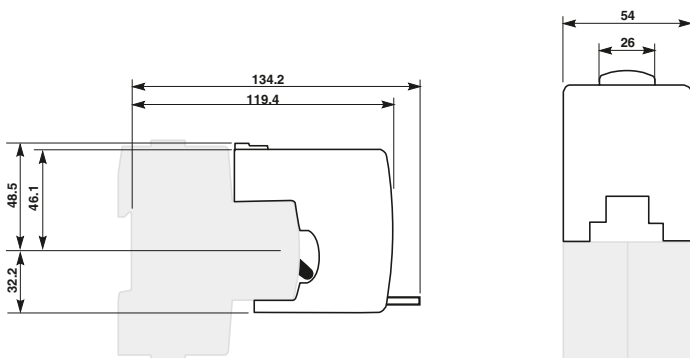

Quick product references

Overall dimensions

S800-RD+S800-RHE, S800-NT, S800-BB250, S800-BBPC120

S800-RD+S800-RHE

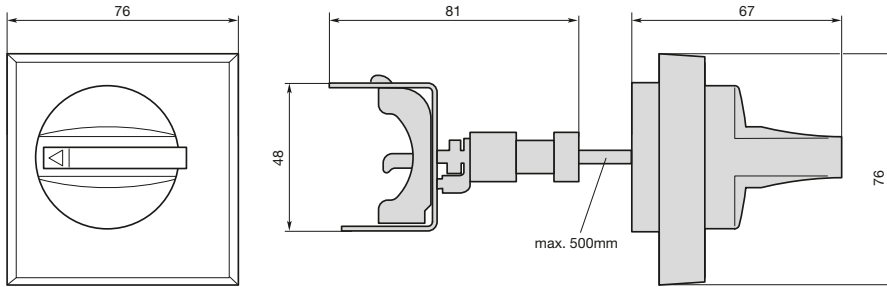

S800-BB250

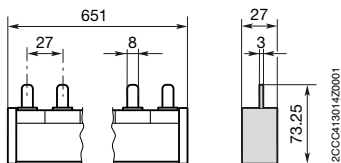

S800-NT

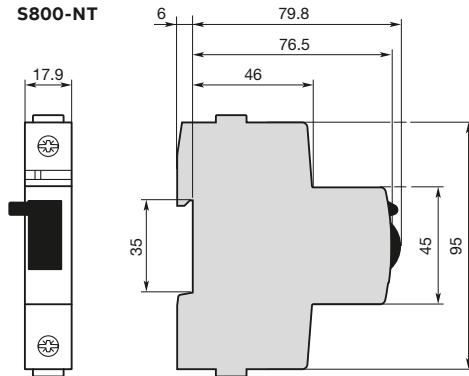

S800-BBPC120

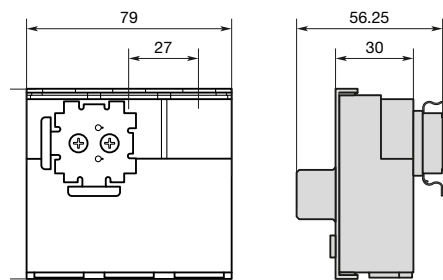

S802-LINK50 S802-LINK125

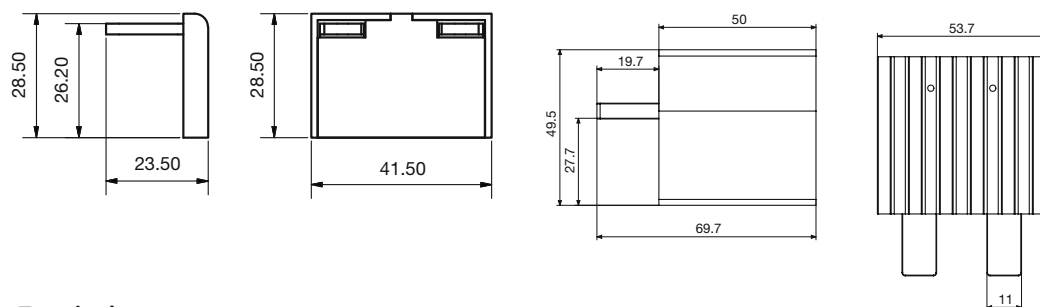

Terminal covers

PCD 2 N

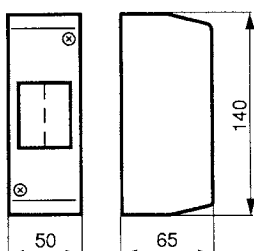

PCD 4 N

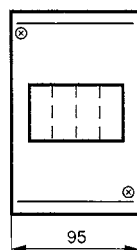

PCD 6 N

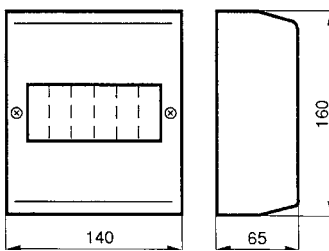

PCD 8 N

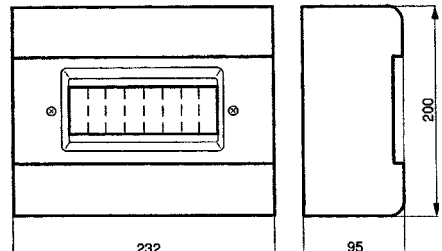

Quick product references

Overall dimensions

Enclosures of moulded-plastic

N + PE common terminals for QES

SMO 4

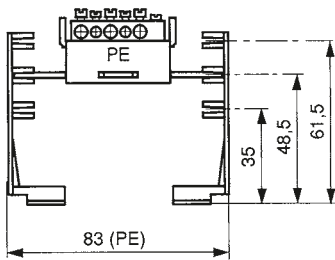

SMO 6

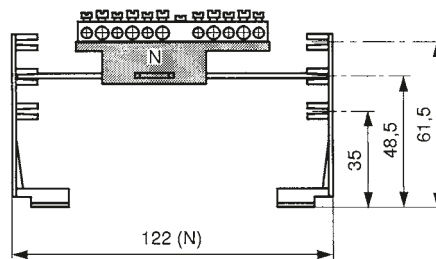
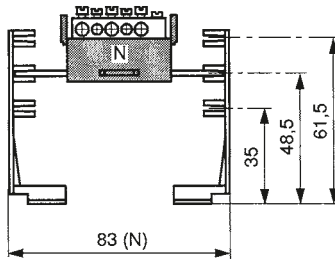
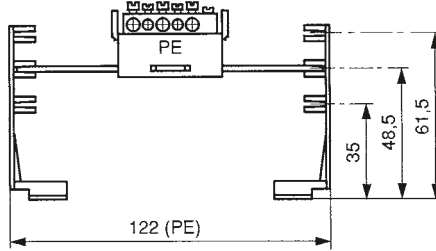

SMO 10

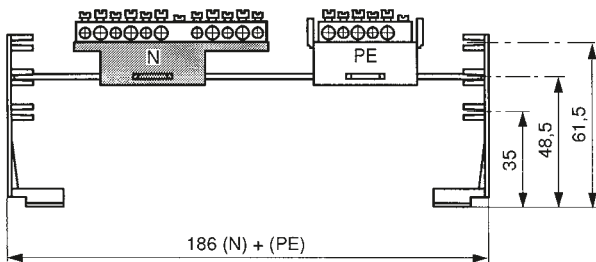

QES 10/3 N

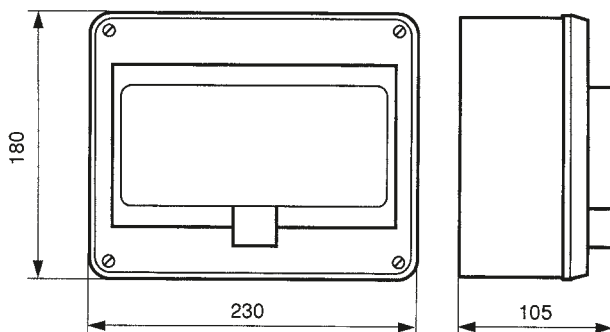

Quick product references

Overall dimensions

Drill holes

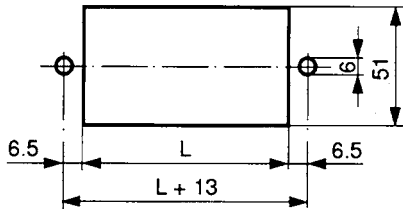

- ① In the case of DSW 1, the drill holes are vertical

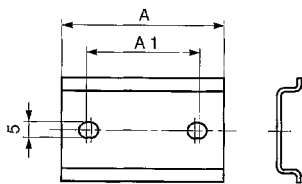

Name	A	A1
DSW	17.5	15
DSW 2	35	20
DSW 3	52.5	37.5
DSW 4	70	55
DSW 6	105	90

Quick product references

Overall dimensions

Busbars

PS 1/2

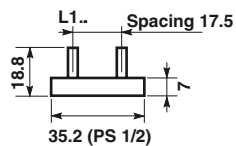

PS 1/6

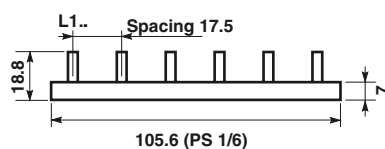

PS 1/9

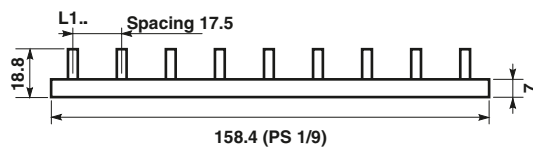

PS 1/12



PS 3/60

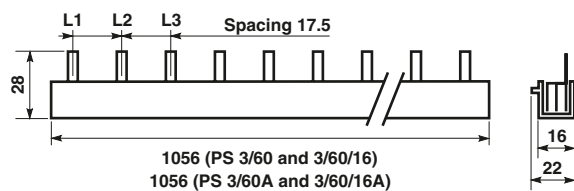

Auxiliary contact bridge HKB

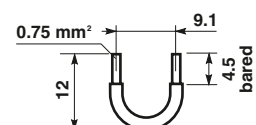

Quick product references

Overall dimensions

PS 3/6

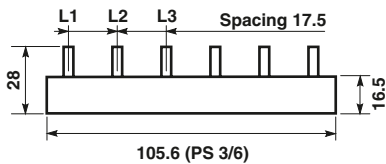

PS 2/12

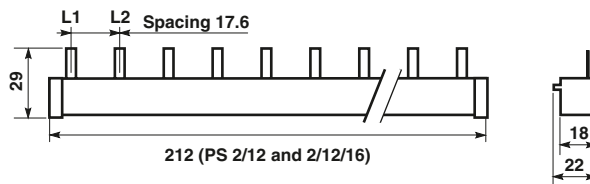

PS 3/9

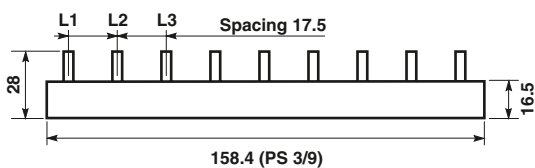

PS 2/58

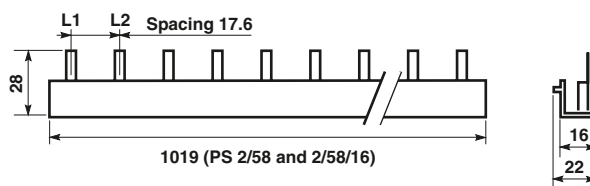

PS 3/12 (2CDL 230 001 R1012)

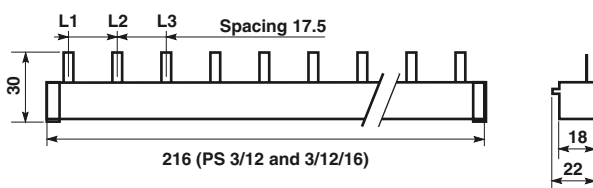

PS 2/48

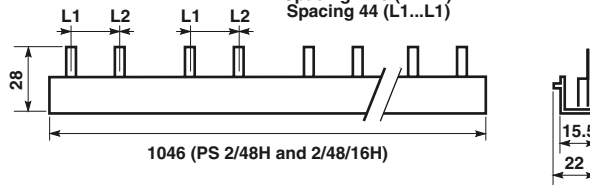

PS 3/12 FI (2CDL 230 002 R1012)

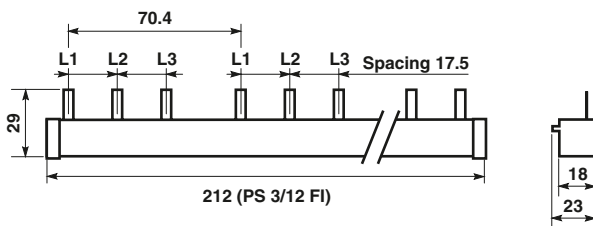

PS 3/39H

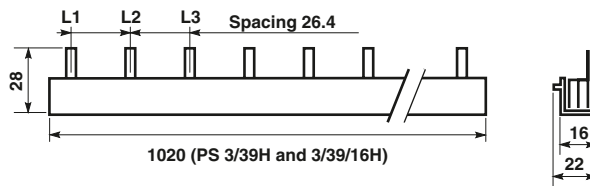

PS 3/48H

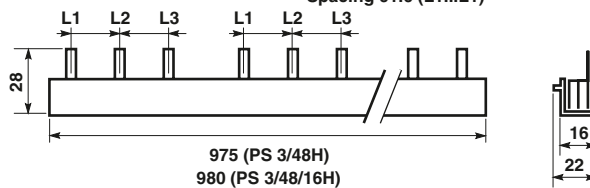

Quick product references

Overall dimensions

PS 3/12 FI H

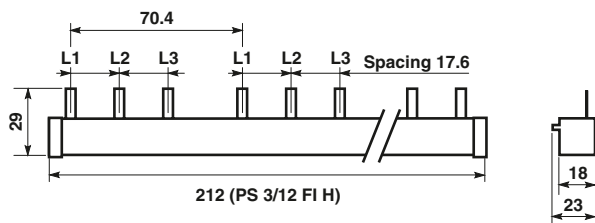

Busbar PS...CB-CR

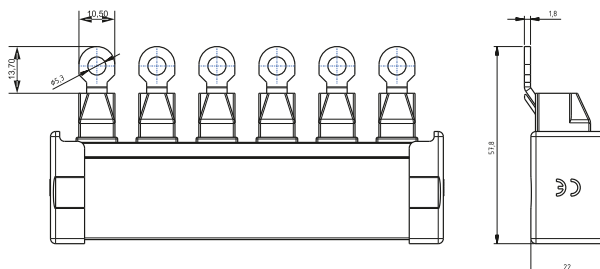

PS 4/12

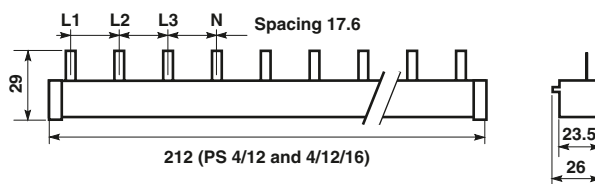

PS 4/60

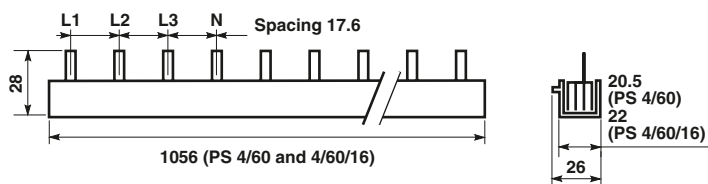

PS 4/58N

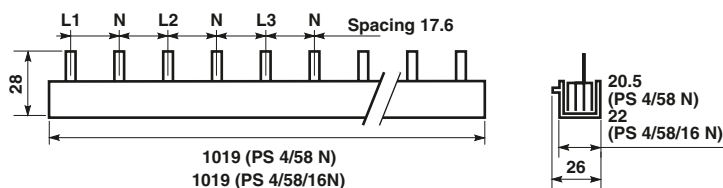

PS 3/12 E 463

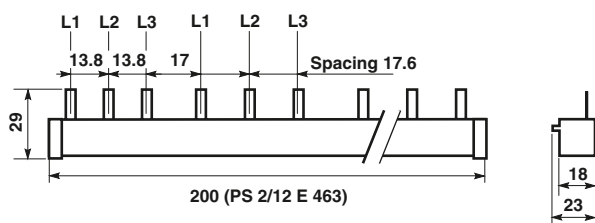

Quick product references

Overall dimensions

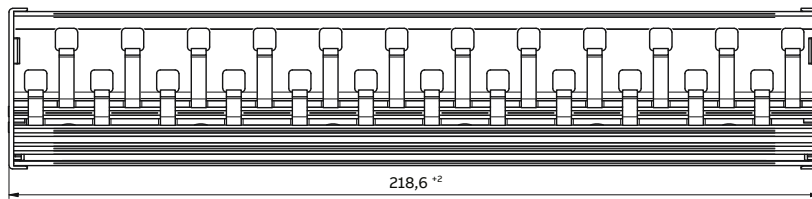
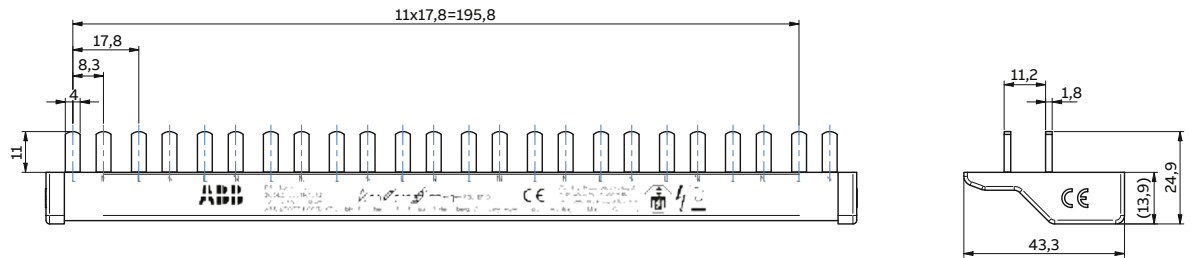

—
PSc 1/24/10 N

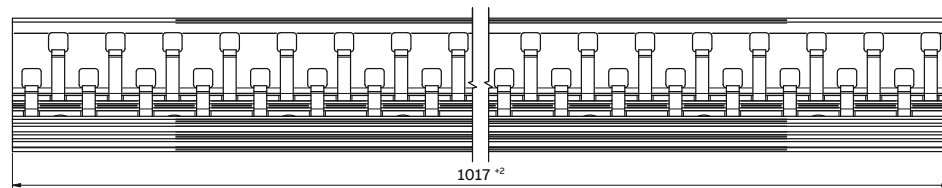
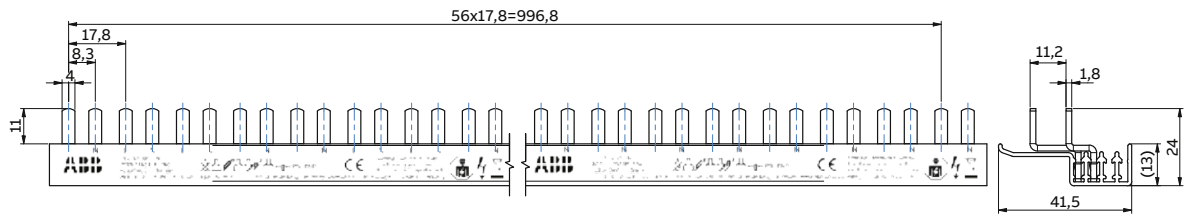

—
PSc 1/120/10 N

Quick product references

Overall dimensions

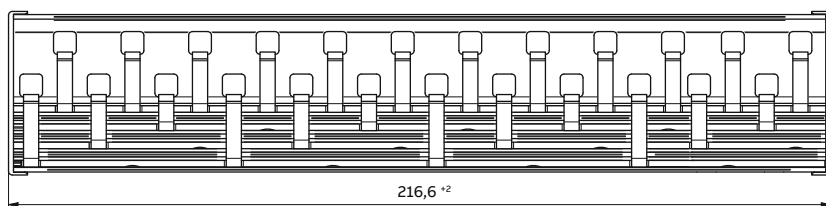
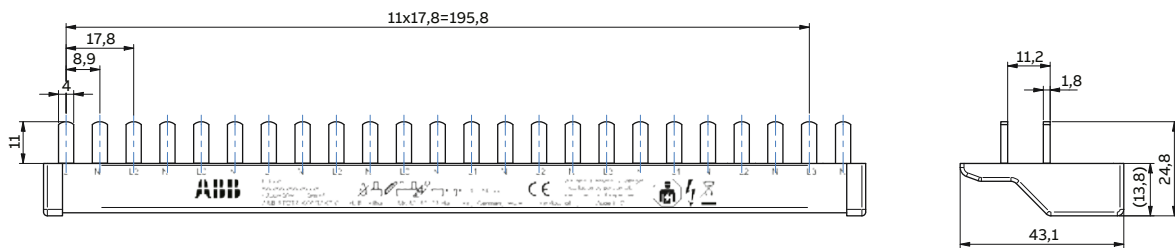

PSc 3/24/10 N

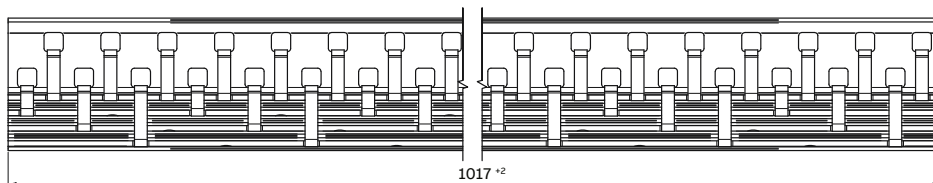
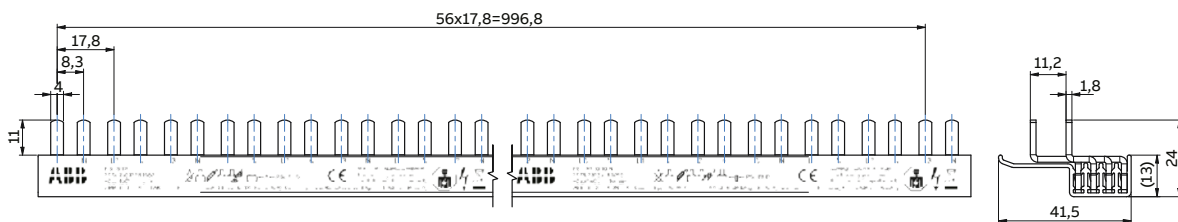

PSc 3/120/10 N

Quick product references

Overall dimensions

Busbars PS...CB and accessories acc. to UL 508

1-phase busbars

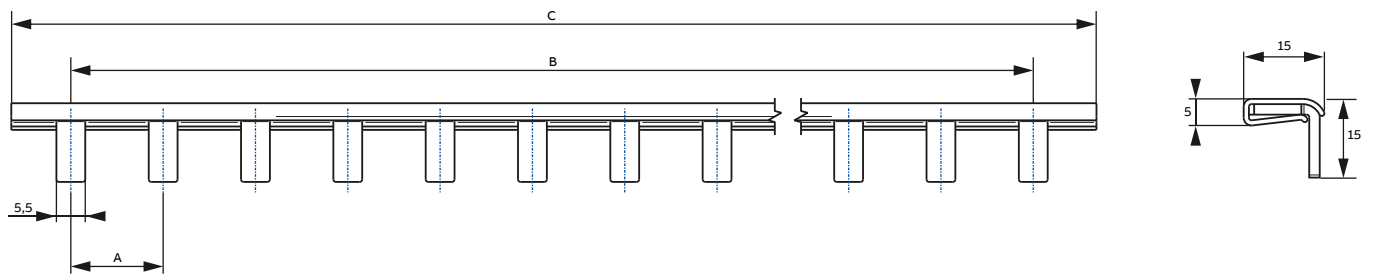

2-/3-phase busbars

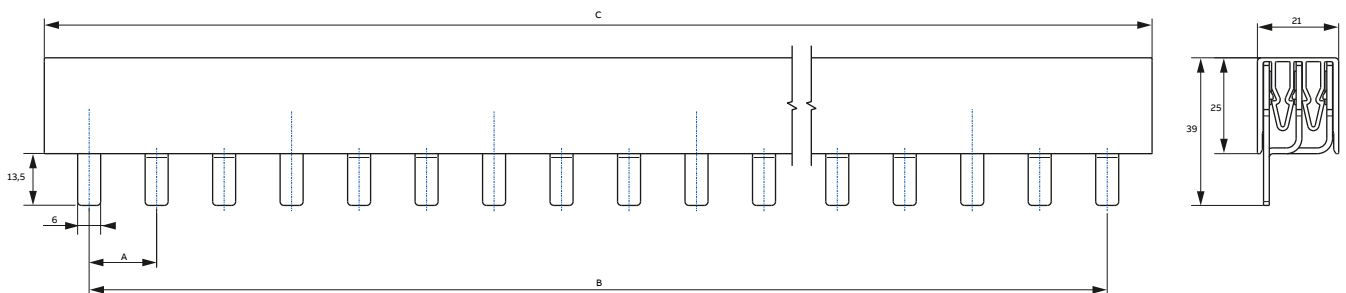

Overall dimensions

Busbar	A mm	B mm	C mm
1-phase busbars			
PS 1/57/18 CB	17.6	986	1010
PS 1/57/25 CB	17.6	986	1010
PS 1/37/18 H CB	26.4	950	985
PS 1/37/25 H CB	26.4	950	985
2-phase busbars			
PS 2/56/18 CB	17.6	968	990
PS 2/56/25 CB	17.6	968	990
PS 2/46/18 H CB	17.6 / 26.4 *	968	1010
PS 2/46/25 H CB	17.6 / 26.4 *	968	990
3-phase busbars			
PS 3/57/18 CB	17.6	986	1010
PS 3/57/25 CB	17.6	986	1010
PS 3/48/18 H CB	17.6 / 26.4 *	924	982
PS 3/48/25 H CB	17.6 / 26.4 *	924	982
PS 3/39/18 H CB	26.4	1003	1040
PS 3/39/25 H CB	26.4	1003	1040

* pin gap for auxiliary

Quick product references

Overall dimensions

ME flange for rear board mounting

DEPHT D

57 mm for S 240-S 250-
S 270-S 280 circuit-breakers

72 mm for S 210 circuit-breakers

TYPE	A	B	C
ME 1 - 1 module	18	40	50
ME 2 - 2 modules	36	57.5	67
ME 3 - 3 modules	54	75.5	85
ME 4 - 4 modules	72	93	103
ME 6 - 6 modules	108	129	139
ME 8 - 8 modules	144	164	172

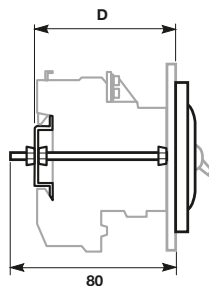
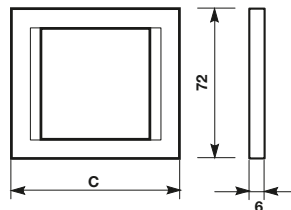
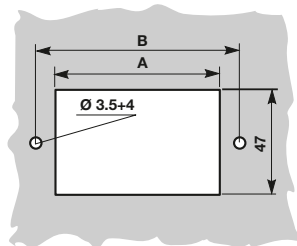

OH_2A_

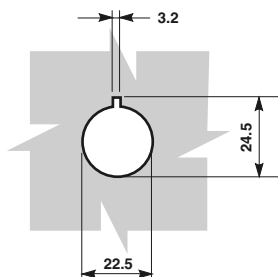
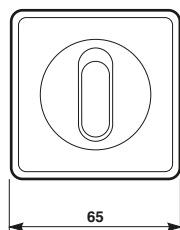
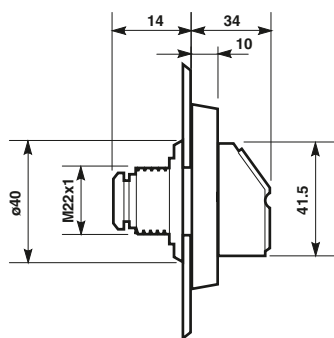

Quick product references

Overall dimensions

E90 50/125

E 90/50

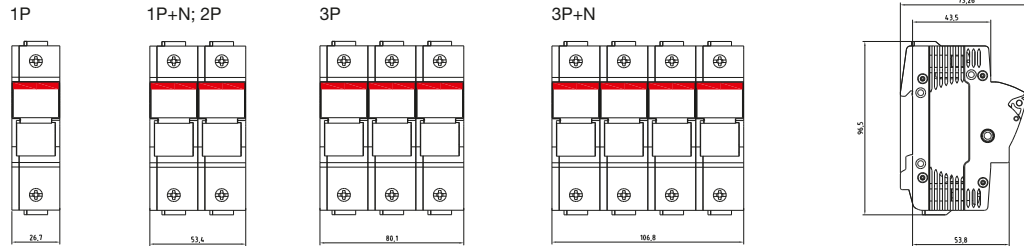

E 90/125

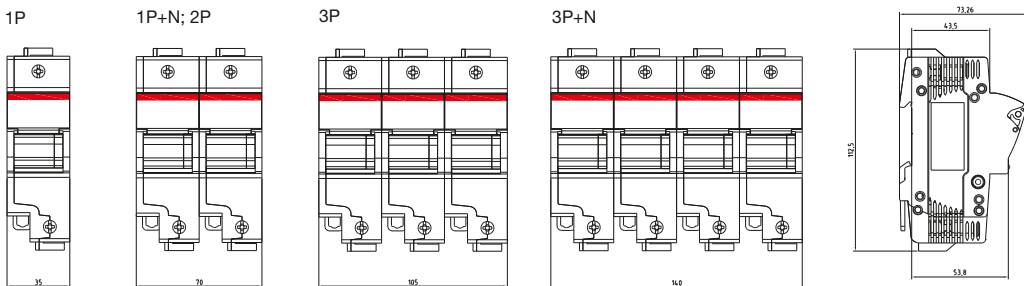

E90 30/60 J class

E 90/30 classJ

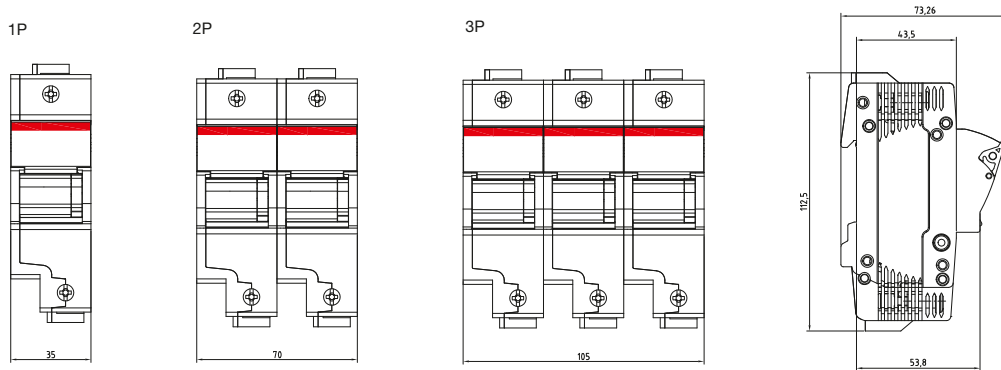

E 90/60 classJ

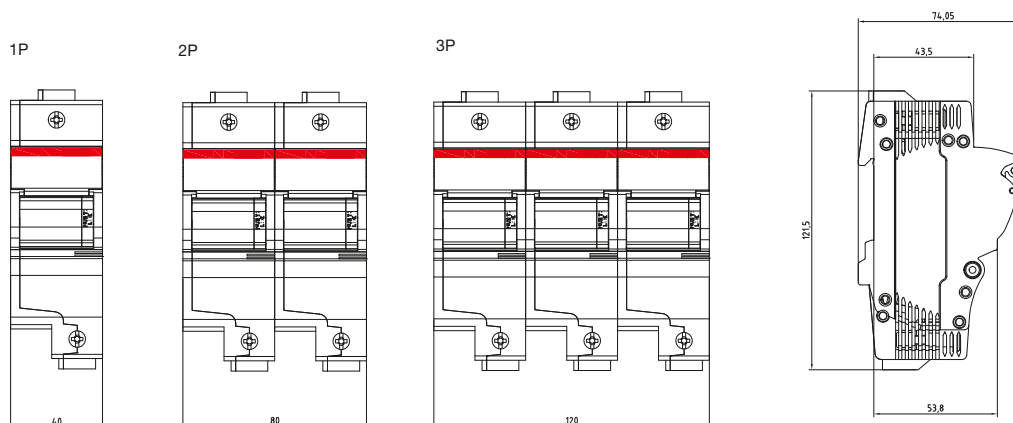

Quick product references

Overall dimensions

E90/32 PV 1500

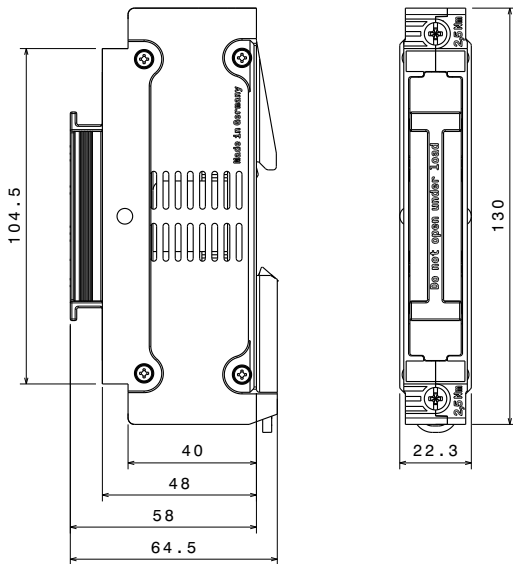

QSD remote signaling panels

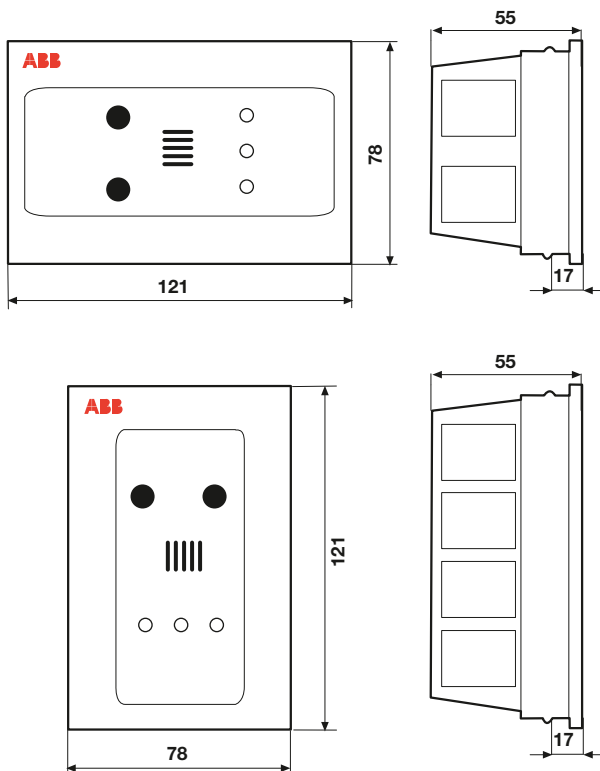

Quick product references

Overall dimensions

QSO electrical switchboard for medical locations

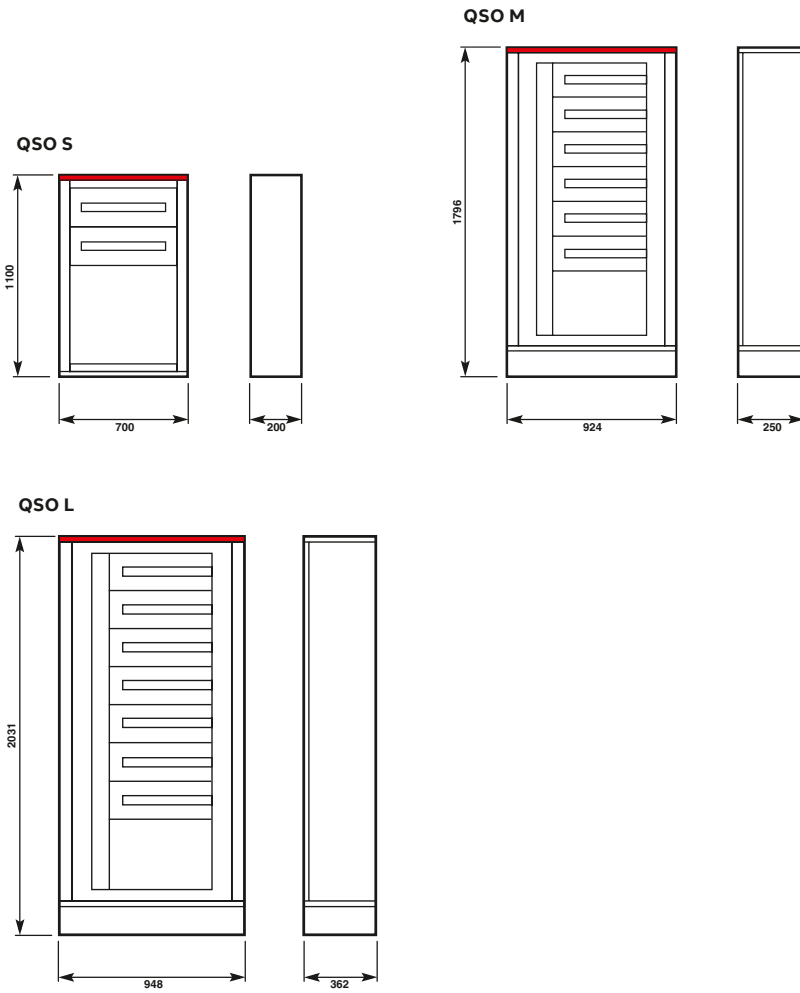

Quick product references

Overall dimensions

TI insulating transformers

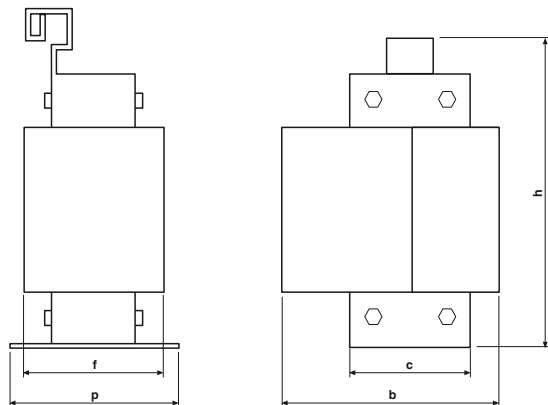

	Rated output [KVA]			
Dimensions	3	5	7,5	10
b [mm]	205	240	240	280
c [mm]	170	170	170	176
f [mm]	115	115	115	173
h [mm]	340	380	380	380
p [mm]	150	150	160	260
Weight [kg]	29,5	44	50,5	73

Quick product references

Overall dimensions

E290 Latching Relays

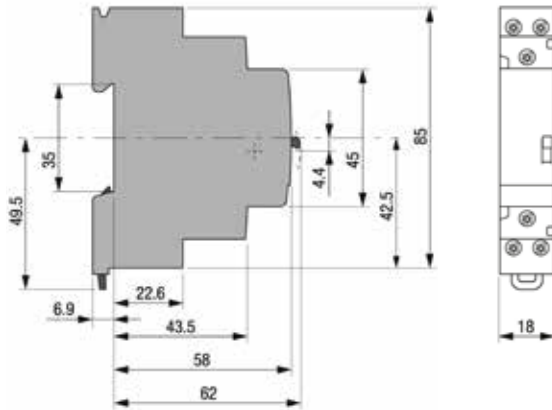

E297 Installation Relays

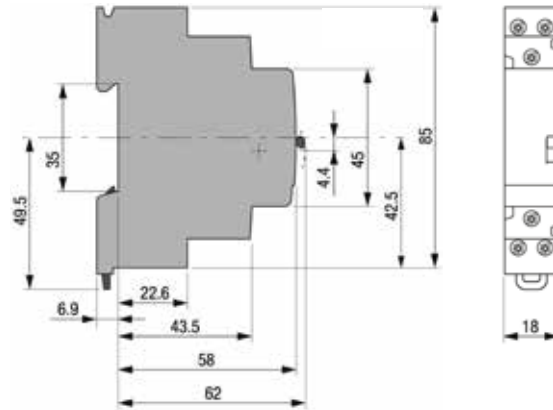

E291S Sequential Latching Relay

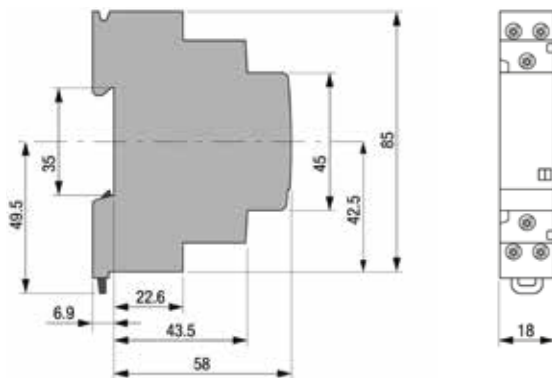

E298 Main Contact Module

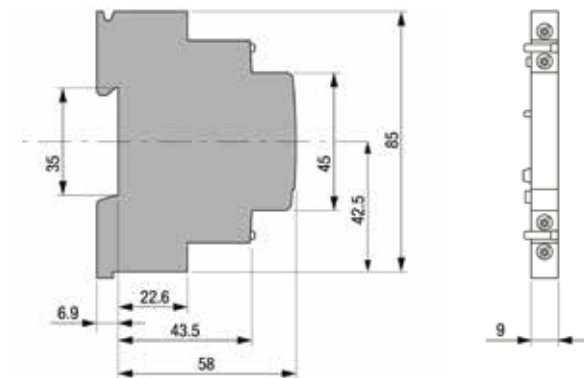

E292 Main Contact Module

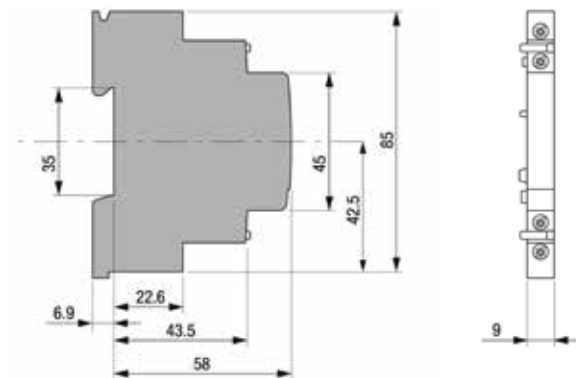

E299-11 Auxiliary Contact

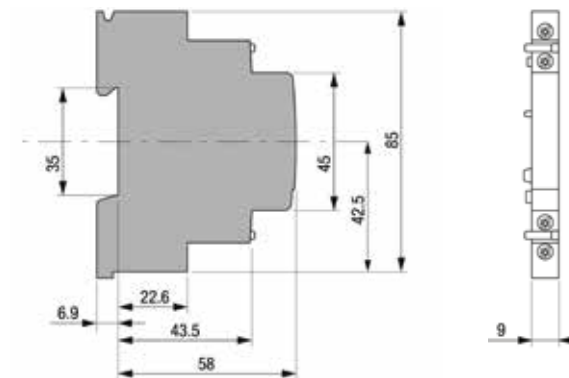

Quick product references

Overall dimensions

E293/X Central On-Off Control Module

(for same control voltage potential)

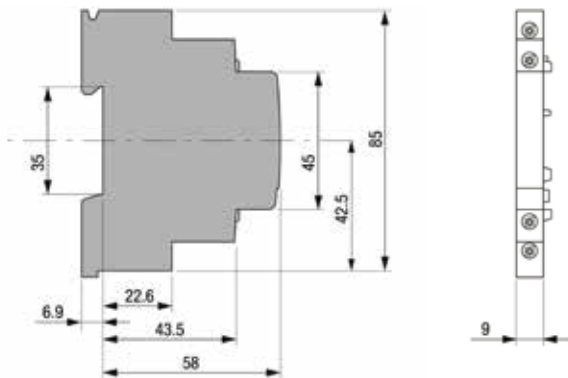

E295-PS Permanent Signal Module

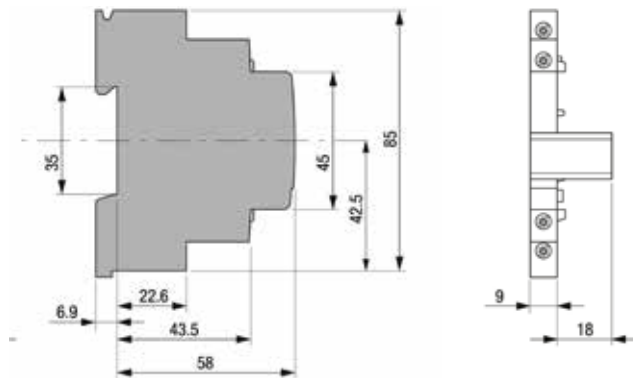

E294 Central On-Off Control Module

(for different control voltage potential)

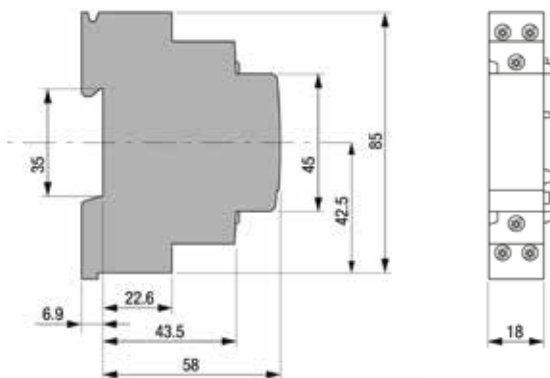

E296-CP Compensator

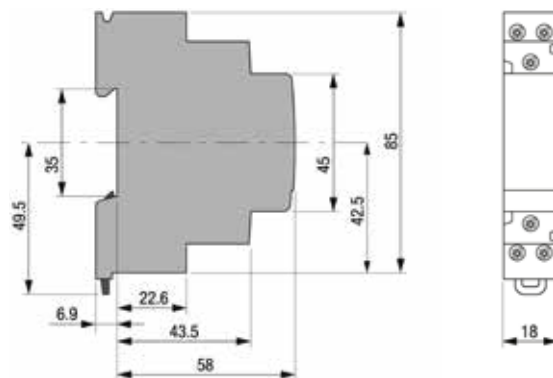

E295-GM Group Module

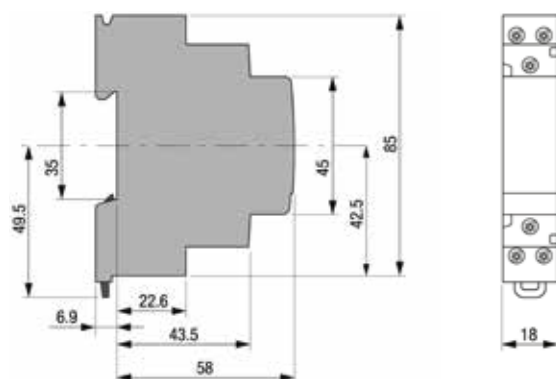

E299-11 Auxiliary Contact

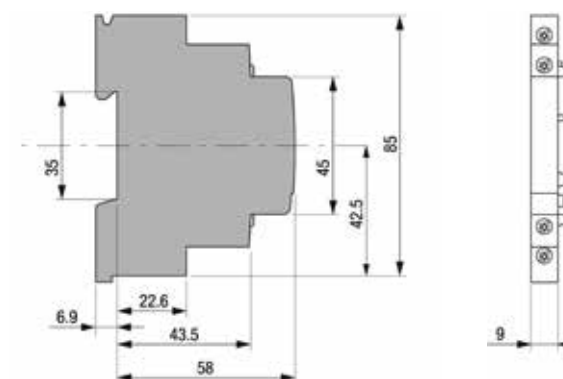

Quick product references

Overall dimensions

FLR pulse relays

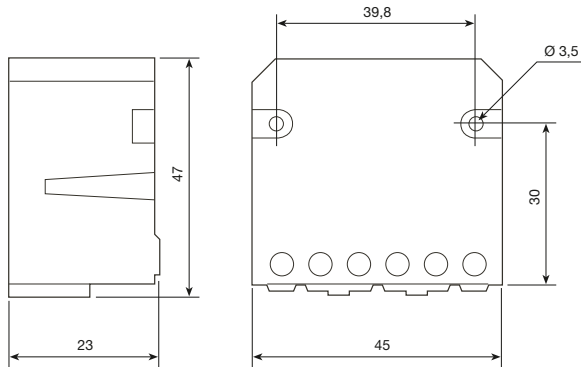

STD dimmers

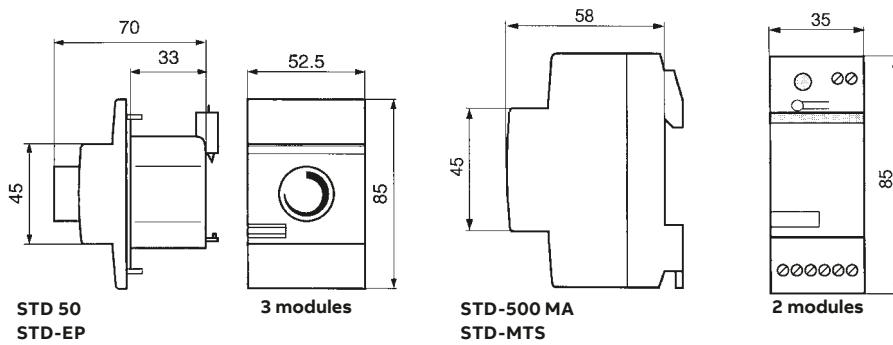

AT72e electro-mechanical time switches

AT72e, AT72e-R, AT72e-7R

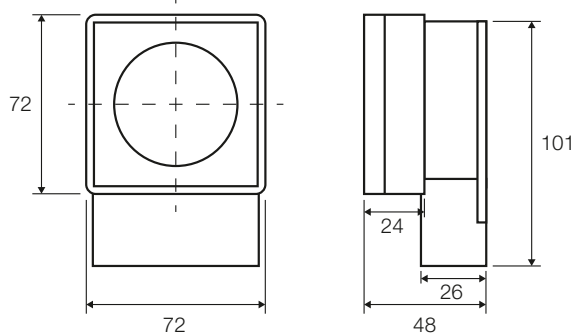

Quick product references

Overall dimensions

T1 POLE

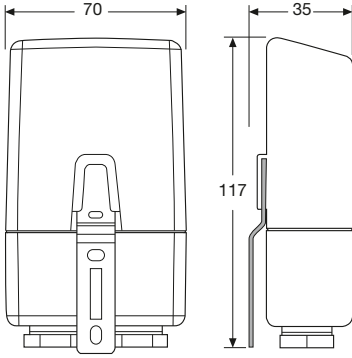

LS-D

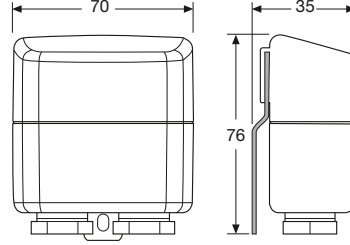

Quick product references

Overall dimensions

MCV - MCA voltmetric and ammetric switches

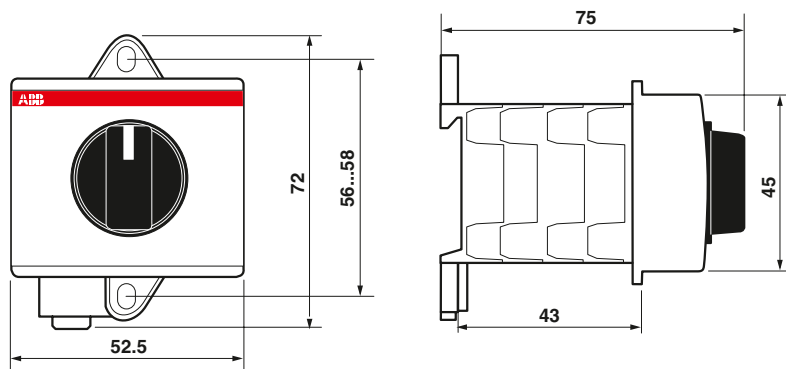

3 modules

QCV - QCA front panel voltmetric and ammetric switches

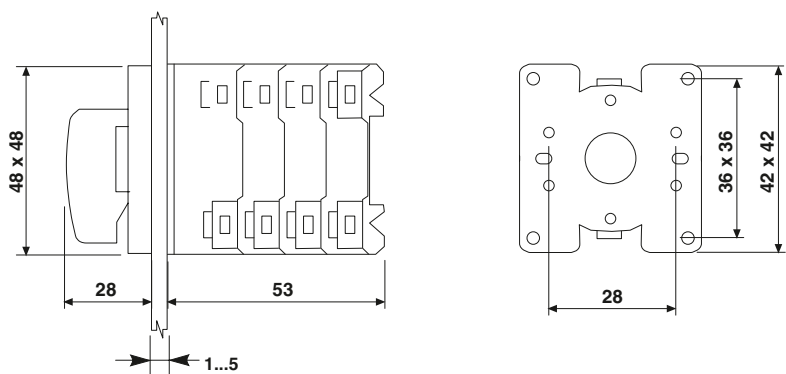

Quick product references

Overall dimensions

Modular current transformers with through primary

TRF M

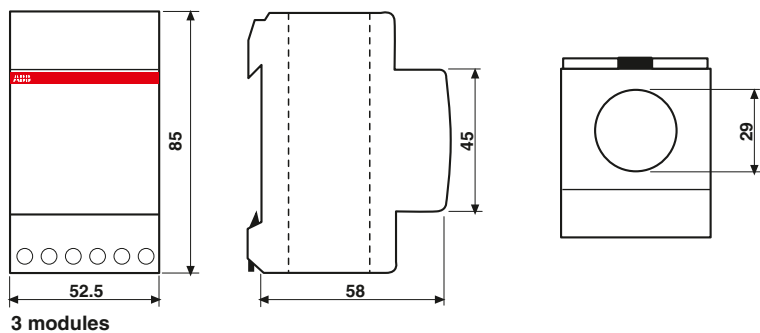

Standard type current transformers.../5 A with wound primary

CTA

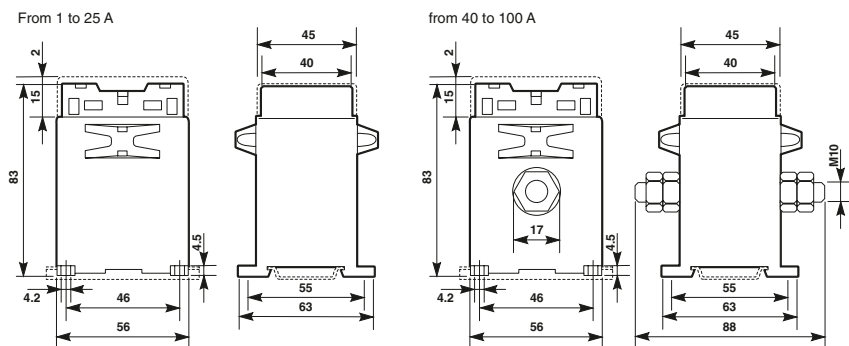

Quick product references

Overall dimensions

Standard type current transformers...5 A with through primary

CT PRO XT

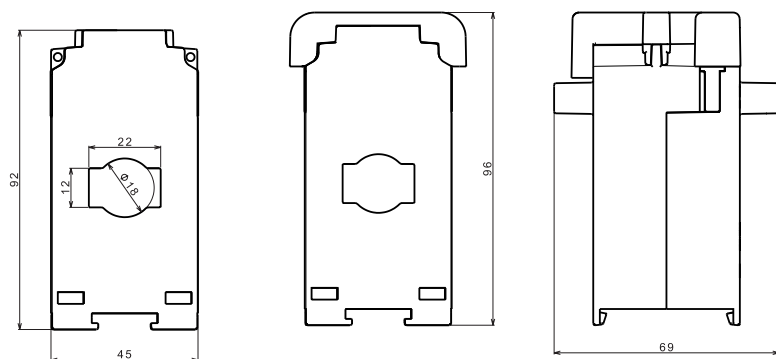

CT MAX

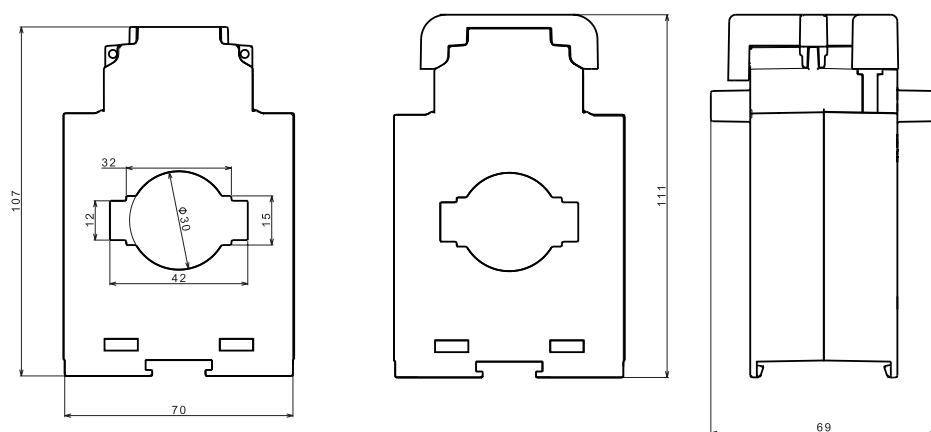

Quick product references

Overall dimensions

CTO

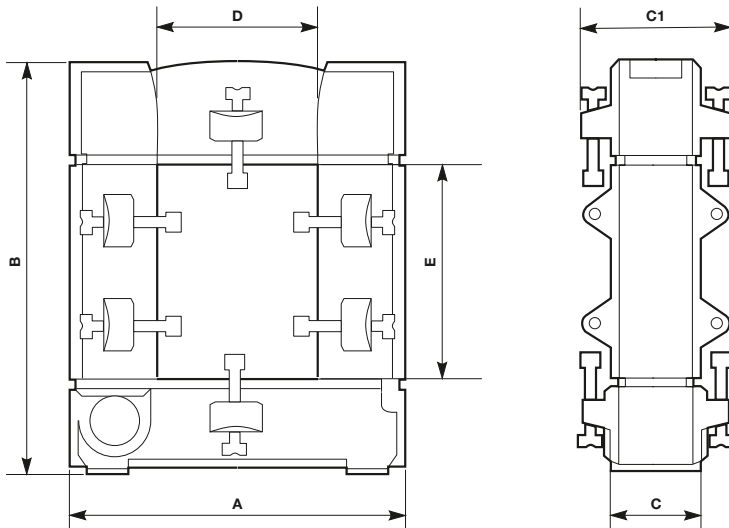

Tipo	A	B	C	C1	D	E
CT30...	93	106	34	58	20	30
CT80...	125	152	34	58	50	80
CT120...	155	198	34	58	80	120

Voltage transformers

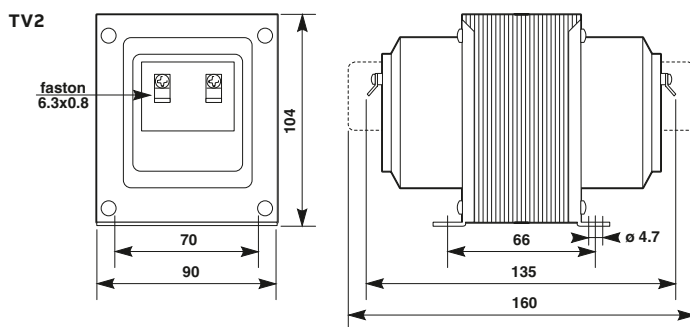

Quick product references

Overall dimensions

Shunts

SNT1 ÷ 25 A/60 mV

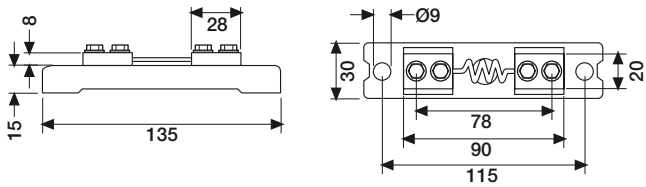

SNT30 ÷ 150 A/60 mV

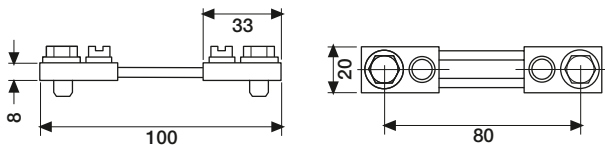

SNT200 ÷ 250 A/60 mV

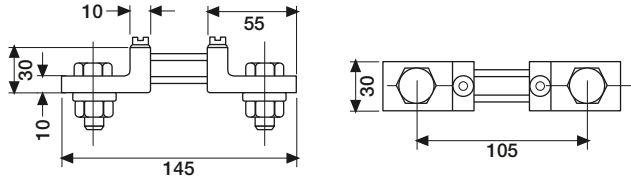

SNT400 ÷ 600 A/60 mV

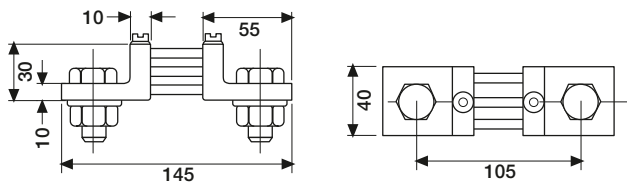

SNT800 ÷ 1000 A/60 mV

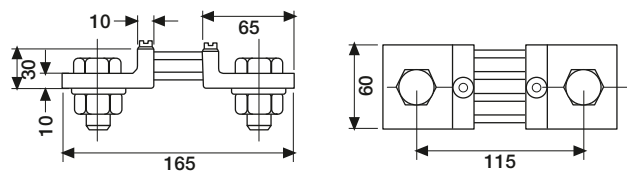

Quick product references

Overall dimensions

TM-C, TM-S, TM-I

from 50 up to 400 VA

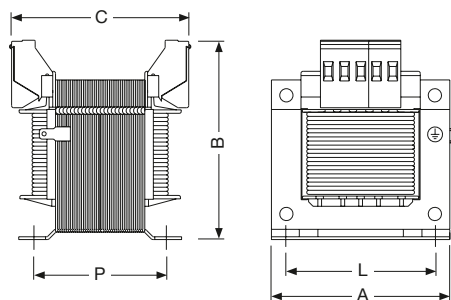

from 630 up to 2500 VA

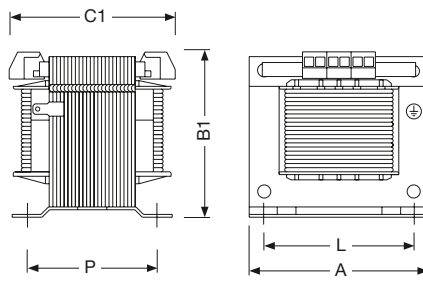

TM-C, TM-S and TM-I Control, Safety and Insulating transformers

Power (VA)	Picture	Dimensions							Screw	Wheigth (Kg)
		A	B	B1	C	C1	P	L		
50	1	80	90	-	74	-	46	56	M4	1.1
100	1	86	96	-	87	-	63	64	M4	2
160	1	100	110	-	90	-	73	84	M5	3
200	1	100	110	-	90	-	73	84	M5	3.2
250	1	100	110	-	110	-	89	84	M5	3.6
320	1	123	122	-	102	-	73	90	M5	4.4
400	1	123	122	-	112	-	85	90	M5	5.5
630	2	154	-	150	-	126	90	122	M6	7.8
1000	2	155	-	150	-	168	133	122	M6	13.2
1600	2	200	-	195	-	200	125	155	M8	21.2
2000	2	200	-	195	-	230	143	155	M8	25.5
2500	2	200	-	195	-	230	153	155	M8	26.8

MA1-8001 DIN rail adapter

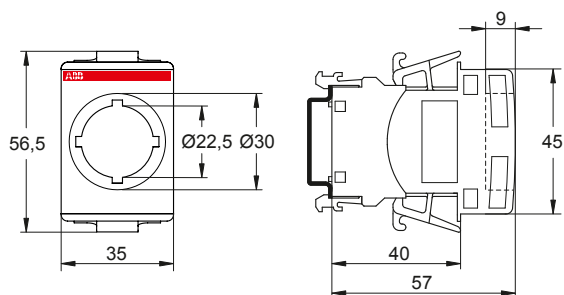

Quick product references

Overall dimensions

1-, 2-, 3- and 4-pole miniature circuit breakers S400

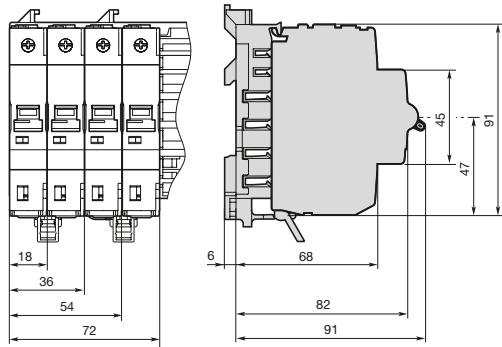

Neutral disconnector

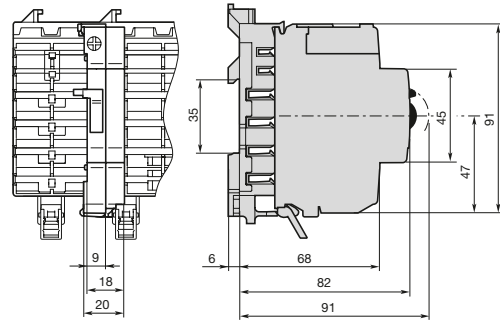

4-pole residual current operated circuit breaker, switch disconnector and surge arrester

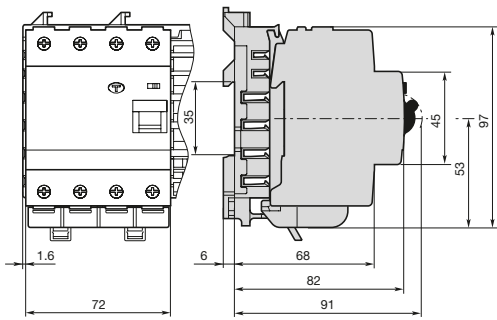

2-pole residual current operated circuit breaker

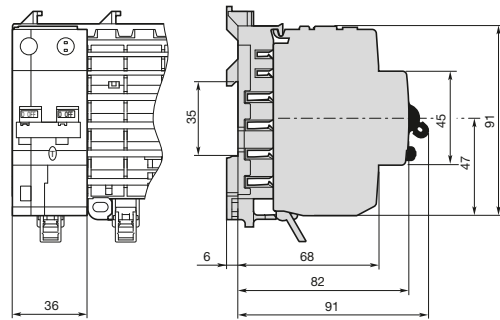

Auxiliary switch and signal contact

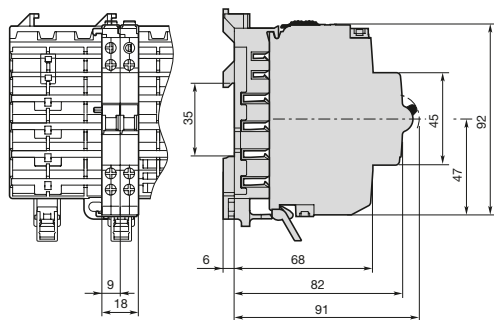

4-pole residual current operated circuit breaker

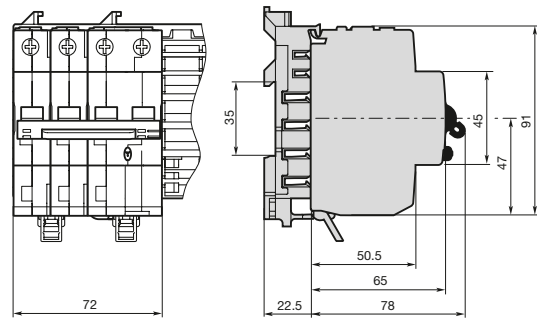

High performance manual motor starter MS325

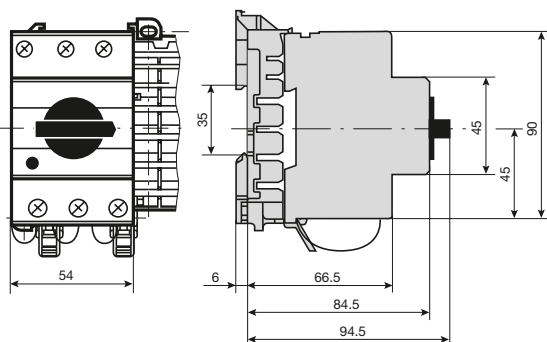

F4C-C M and F4C-AR I

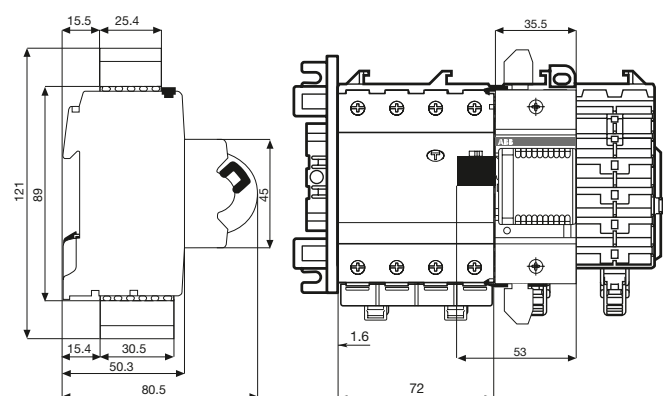

Quick product references

Overall dimensions

Incoming terminal blocks 100 A/160 A

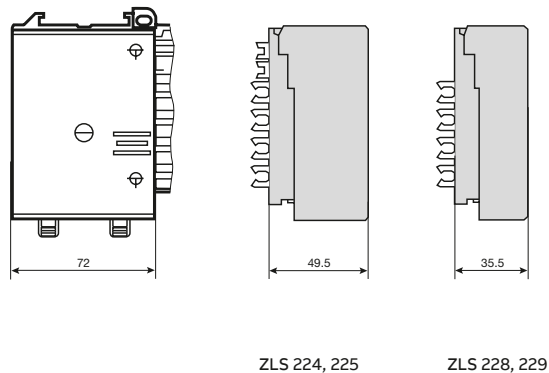

Incoming terminal component 200 A

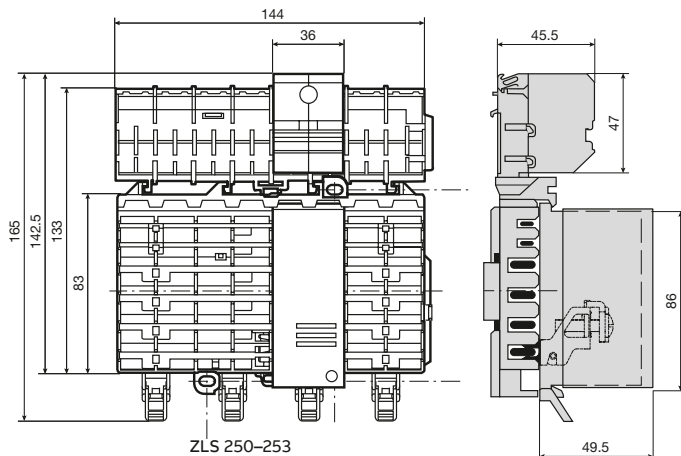

Incoming terminal blocks 63 A Incoming terminal block LA, LB

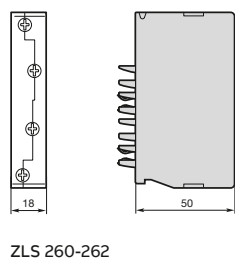

Universal adapter 32 A, 63 A

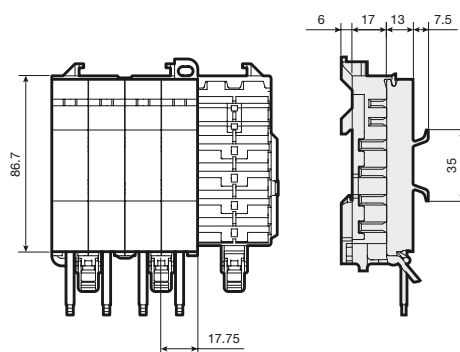

Socket base Z LS908 Receptacle – 8 dimensional units

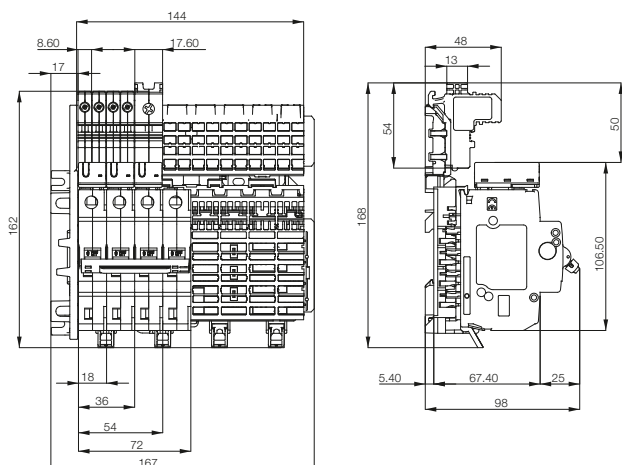

Socket base Z LS906 Receptacle – 6 dimensional units

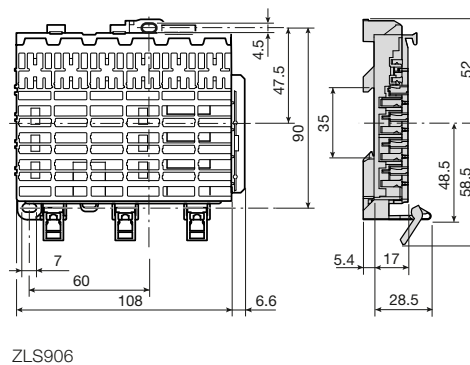

Quick product references

Overall dimensions

Intermediate piece ZLS 725

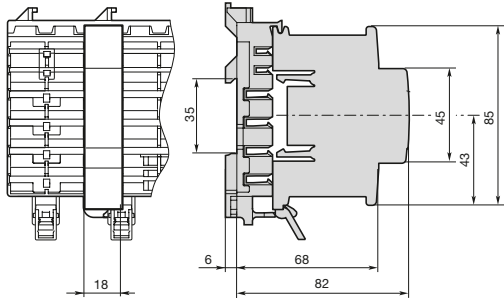

Combi module ZMS132, Adapter MS116/132

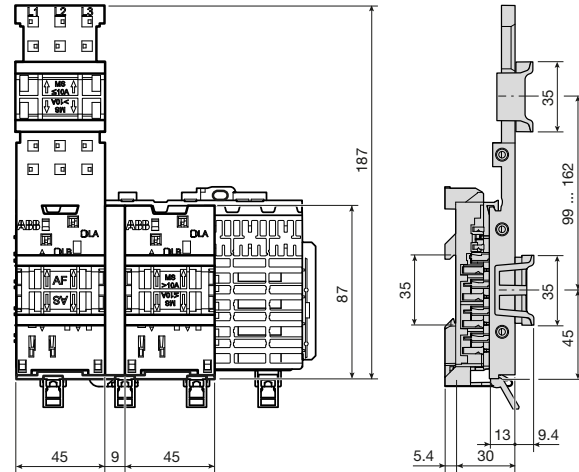

Busbar cover ZLS100

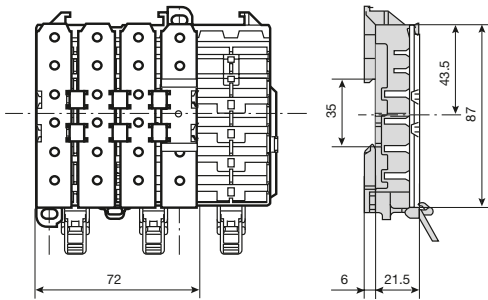

Extension adapter ZLS101

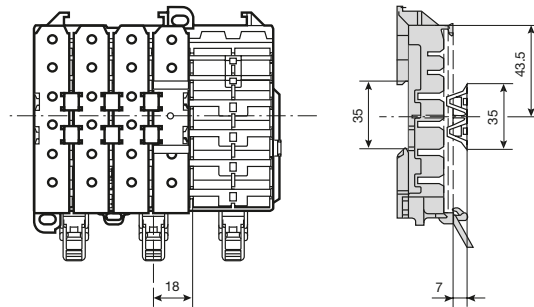

Sensor (CMS-100PS)

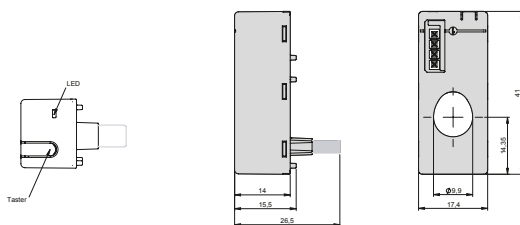

Control Unit (600)

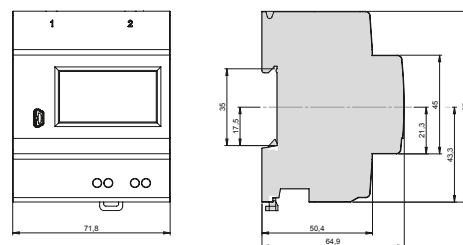

Quick product references

Overall dimensions

UK600 Flush-mounting series – Consumer unit

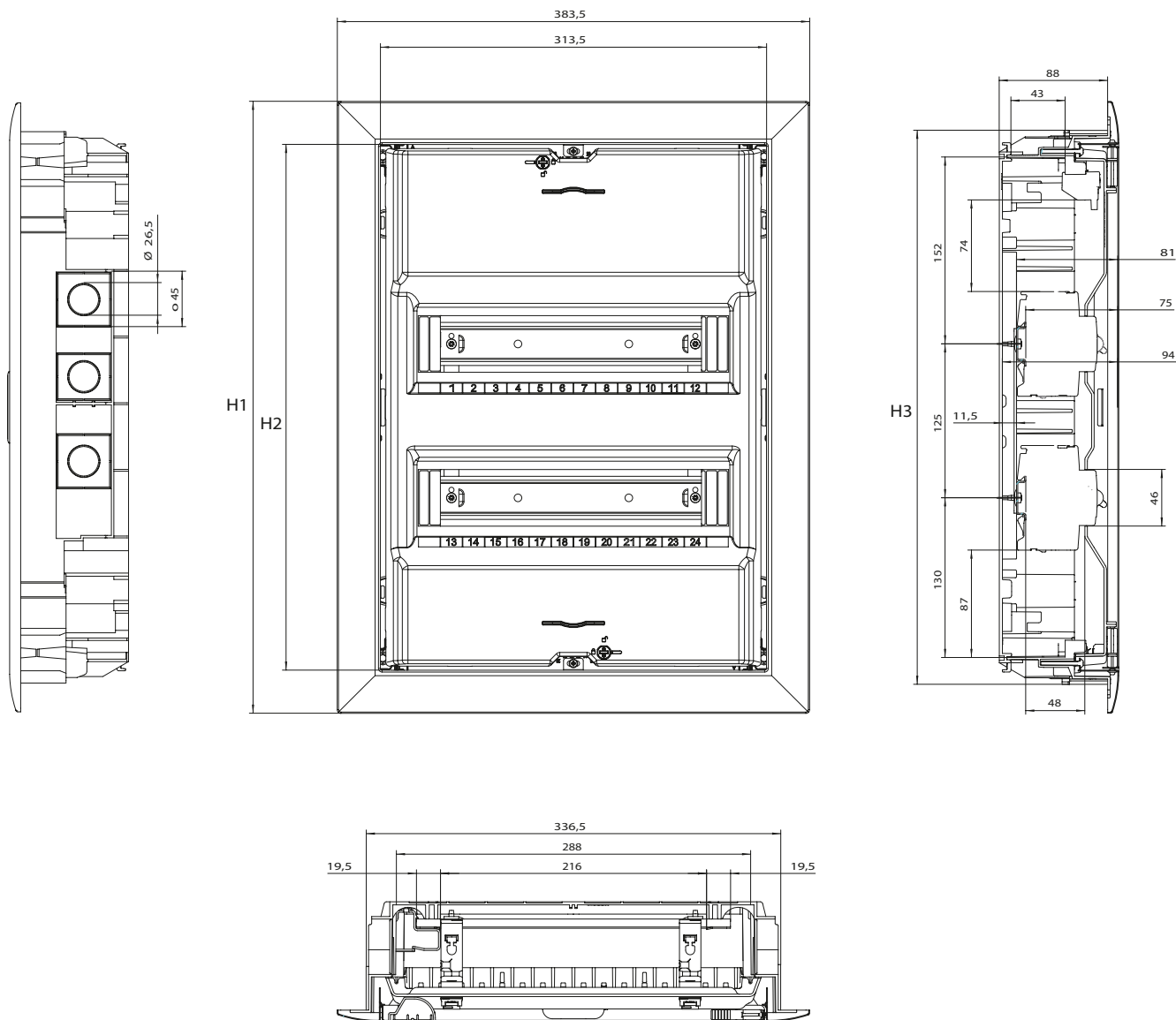

Type	Allowed power loss P _{zul} according to DIN 43671 (W)			Max. output capacity P _{de} in accordance with DIN VDE 60670-24 (W)			Dimensions in mm		
	20K	25K	30K	20K	25K	30K	H1	H2	H3
UK61..	10.0	13.0	16.0	27.8	34.1	41.0	372	302	325
UK62..	11.5	15.0	19.0	38.0	46.5	56.0	497	427	450
UK63..	14.5	19.0	24.0	40.7	49.8	60.0	622	552	575
UK64..	16.5	21.5	27.0	47.7	58.8	71.0	747	677	700
UK66..				56.0	69.0	83.0	872	802	825

Quick product references

Overall dimensions

UK600 Flush-mounting series – Media enclosure

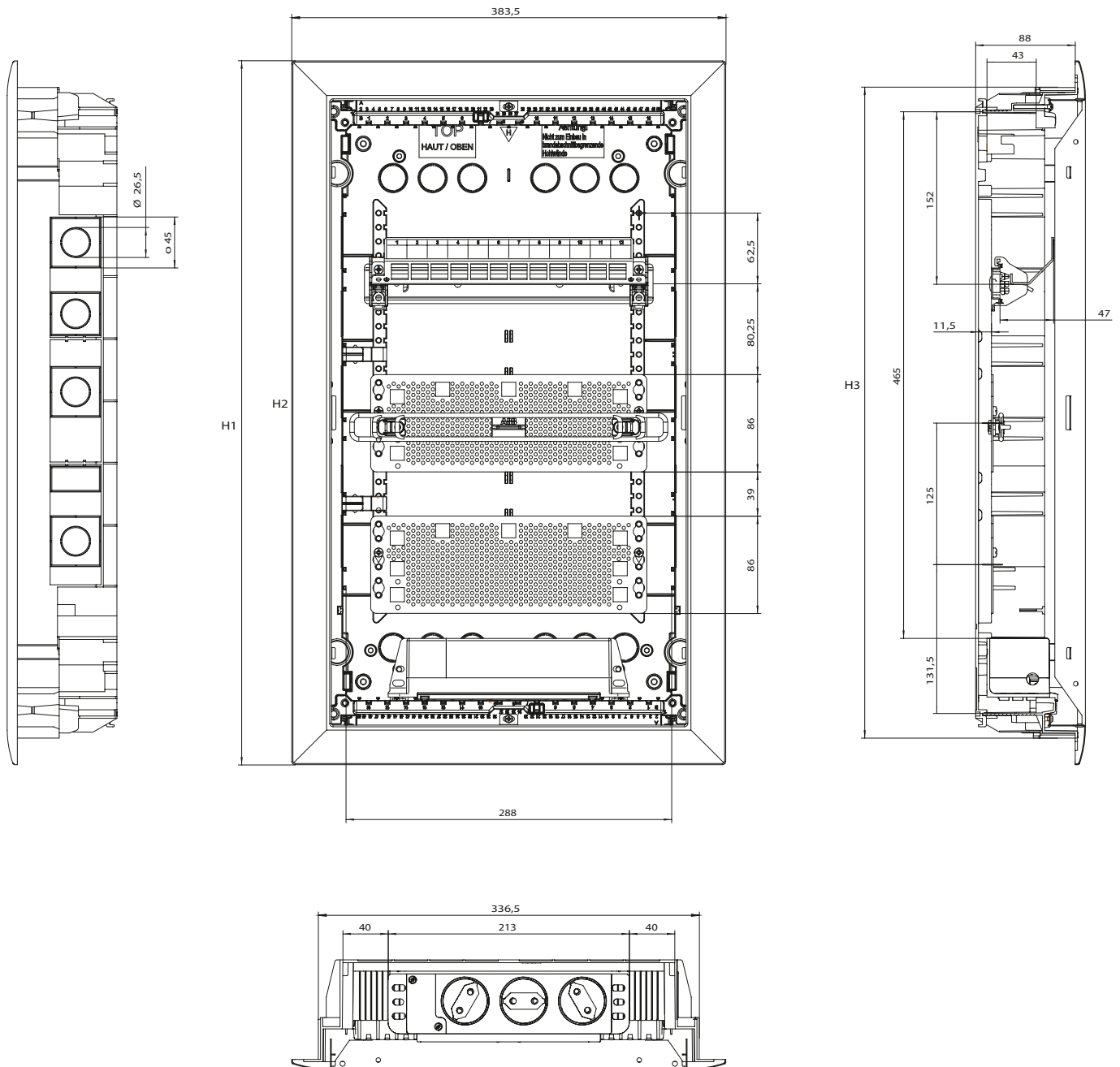

Type	Allowed power loss Pzul according to DIN 43671 (W)			Max. output capacity P de in accordance with DIN VDE 60670-24 (W)			Dimensions in mm		
	20K	25K	30K	20K	25K	30K	H1	H2	H3
UK62..	11.5	15.0	19.0	38.0	46.5	56.0	497	427	450
UK63..	14.5	19.0	24.0	40.7	49.8	60.0	622	552	575
UK64..	16.5	21.5	27.0	47.7	58.8	71.0	747	677	700
UK66..				56.0	69.0	83.0	872	802	825

Quick product references

Overall dimensions

UK600 Flush-mounting series – Combi enclosure

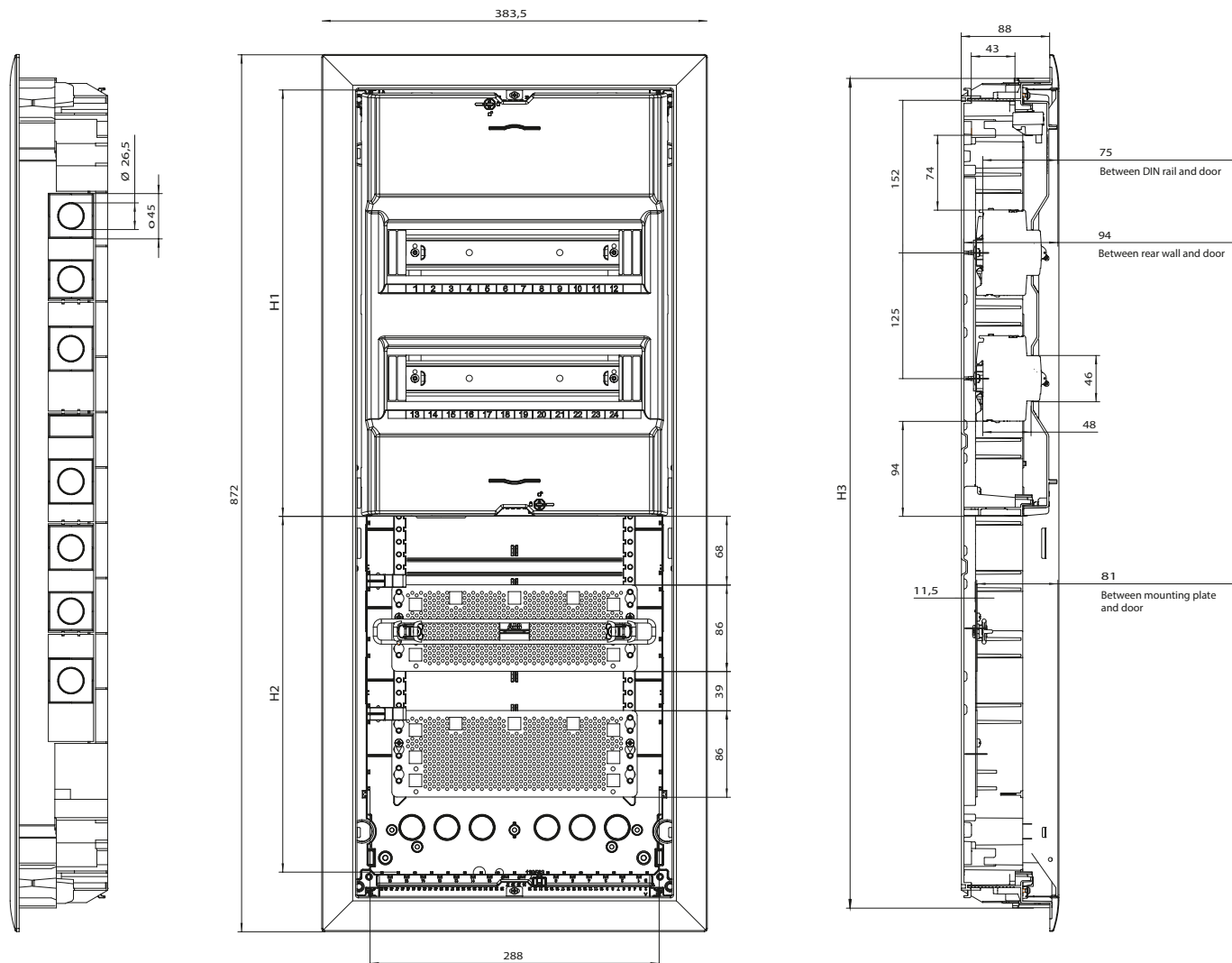

Type	Allowed power loss P _{zul} according to DIN 43671 (W)			Max. output capacity P _{de} in accordance with DIN VDE 60670-24 (W)			Dimensions in mm	
	20K	25K	30K	20K	25K	30K	H1	H2
UK662..				56.0	69.0	83.0	424	353
UK663..				56.0	69.0	83.0	549	228

Quick product references

Overall dimensions

UK600 Flush-mounting series – Trim frame and door

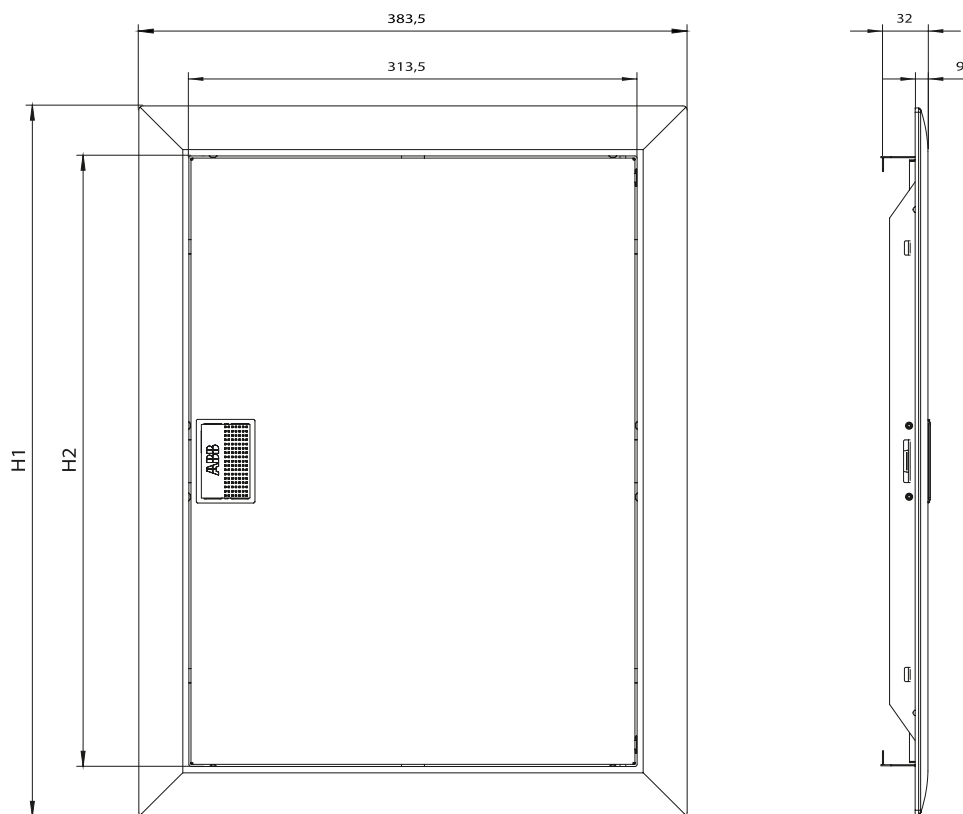

Type	Dimensions in mm	
	H1	H2
BL610	302	372
BL620	497	427
BL630	622	552
BL630	622	552
BL640	747	677
BL650	872	802

Quick product references

Overall dimensions

UK600 Flush-mounting series – Interchangeable design frame

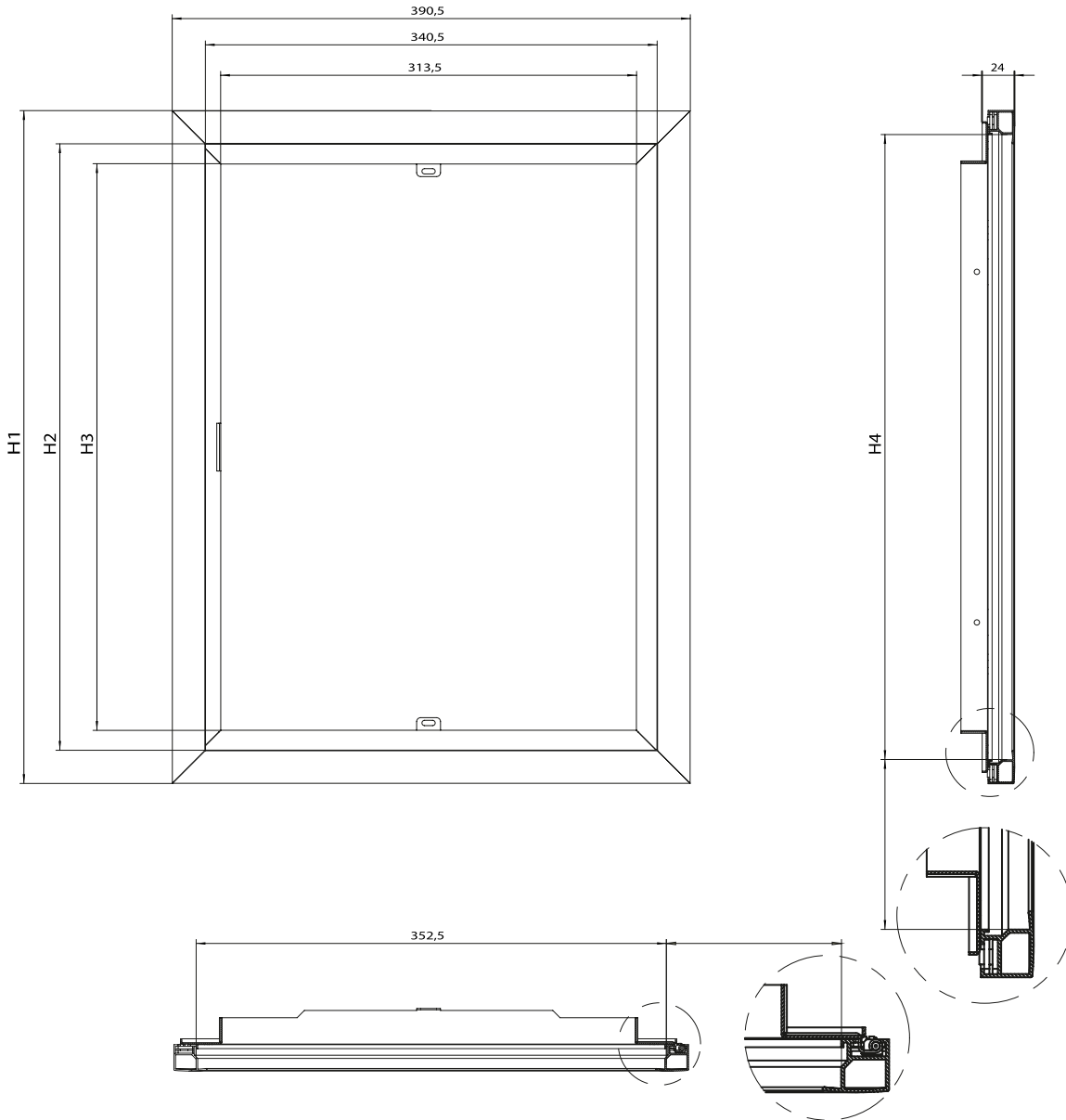

Type	Dimensions in mm				Technical specifications LED panel			
	H1	H2	H3	H4	Type	U	P	Colour temperature
BL520D	507	457	427	469	UZD624	12V DC	9.60 W	4200 K
BL630D	632	582	552	594	UZD634	12V DC	13.20W	4200 K
BL640D	757	707	677	719	UZD644	12V DC	15.60W	4200 K
BL650D	882	832	802	844	UZD654	12V DC	19.60W	4200 K

Quick product references

Overall dimensions

System pro E comfort MISTRAL41F

Box	
Modules	diam. 32
4M	4
6M	4
8M	4
12M	4
18M	4
24M	8
36M - 2F	8
36M - 3F	12
48M	16
54M	12
72M	16

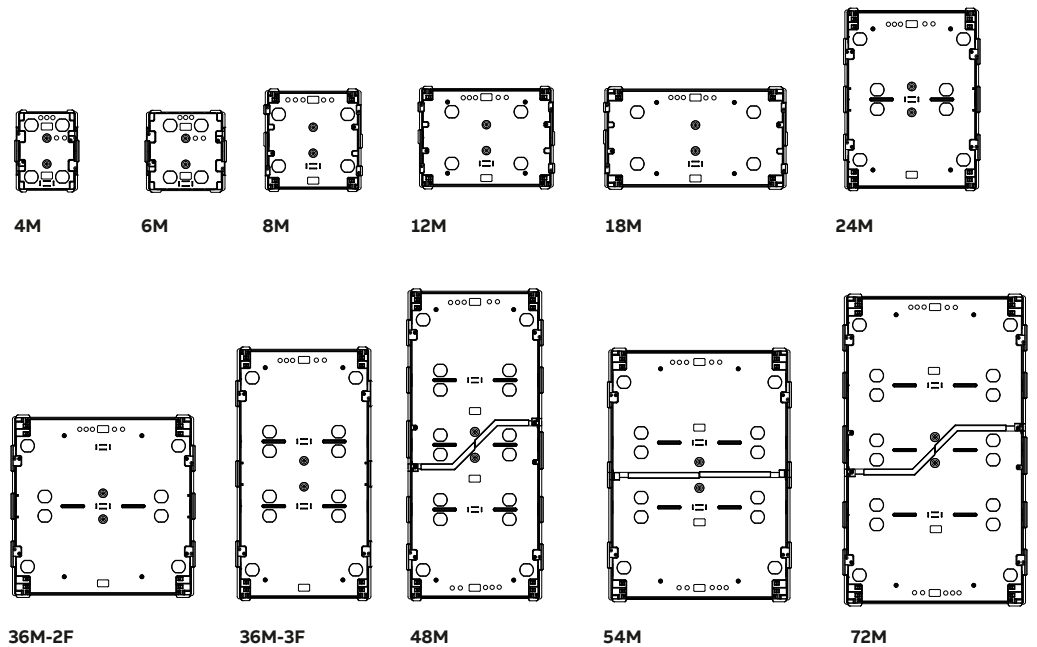

Site	
Modules	diam. 32
4M	1
6M	1
8M	1
12M	1
18M	1
24M	3
36M - 2F	3
36M - 3F	4
48M	5
54M	4
72M	5

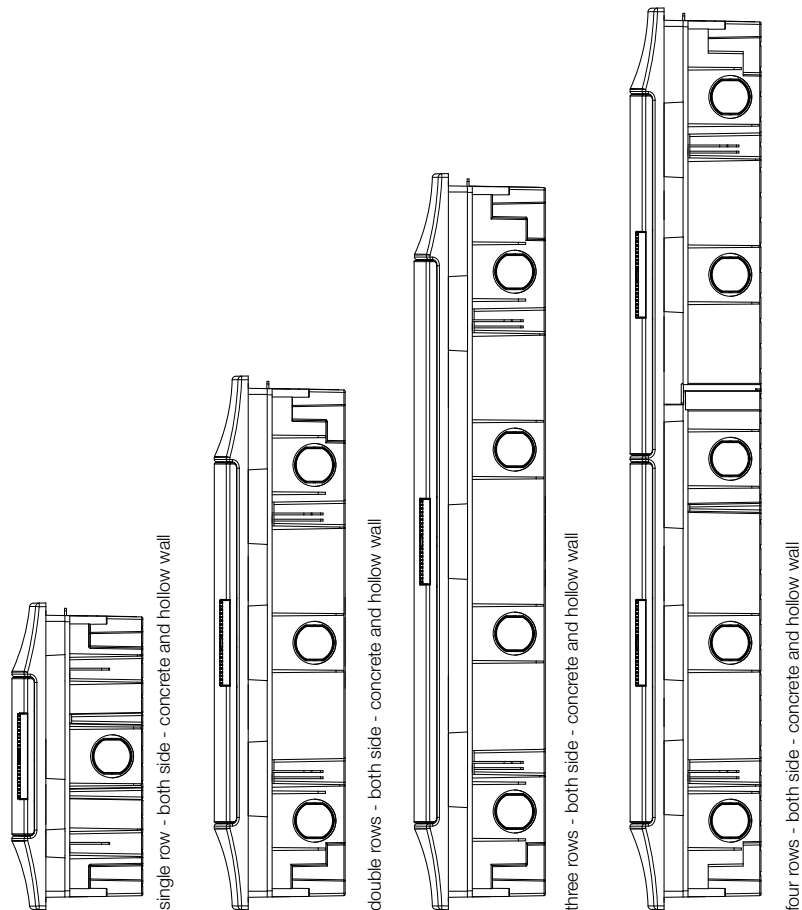

Quick product references

Overall dimensions

Hollow wall holes dimensions

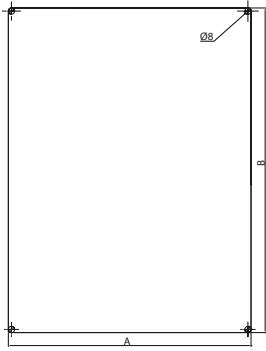

	A	B
4M	143	183
6M	183	183
8M	223	231
12M	311	231
18M	421	231
24M	311	416
36M - 2F	421	416
36M - 3F	311	581
48M	311	716
54M	421	581
72M	421	716

Cable entry

Modules	diam. 40	diam. 32	diam. 25	diam. 20	Flange
4	-	-	3	3	///
6	-	-	5	5	///
8	-	1	9	-	150x55
12	1	8	4	-	240x55
18	1	12	2	-	330x55

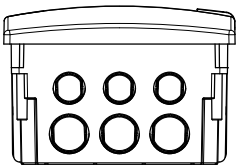

4 modules - top and bottom - concrete and hollow wall

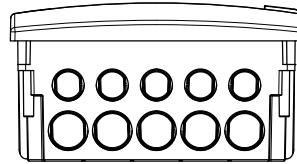

6 modules - top and bottom - concrete and hollow wall

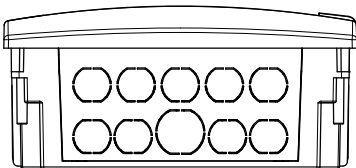

8 modules - top and bottom - hollow wall

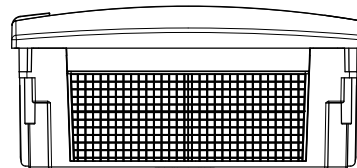

8 modules - top and bottom - concrete wall

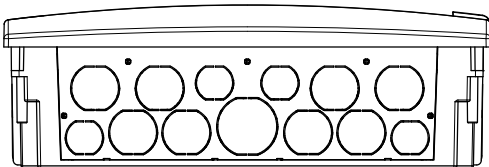

12 modules - top and bottom - hollow wall

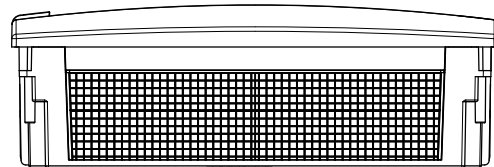

12 modules - top and bottom - concrete wall

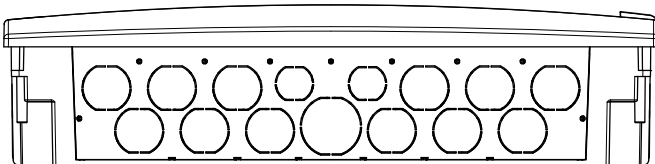

18 modules - top and bottom - hollow wall

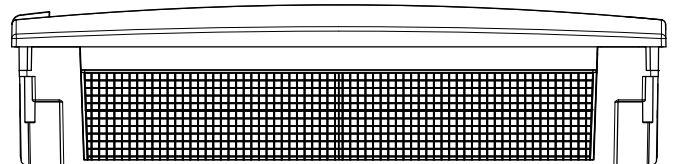

18 modules - top and bottom - concrete wall

Quick product references

Overall dimensions

System pro E comfort MISTRAL41F

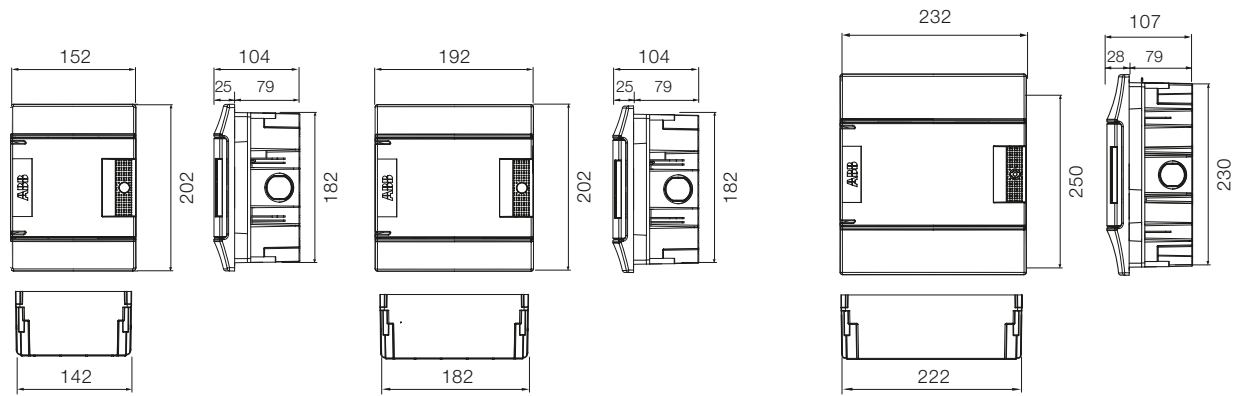

4 modules

6 modules

8 modules

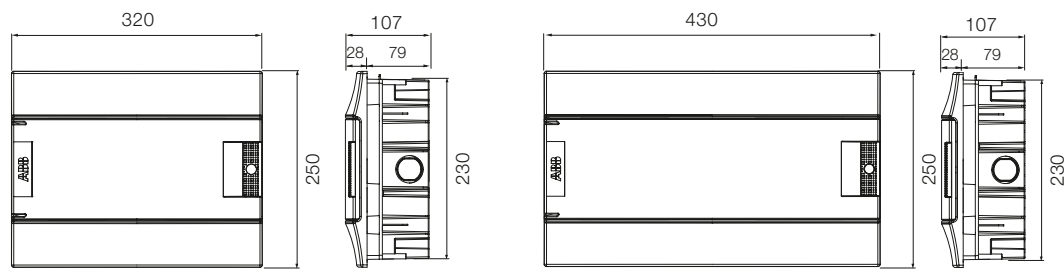

12 modules

18 modules

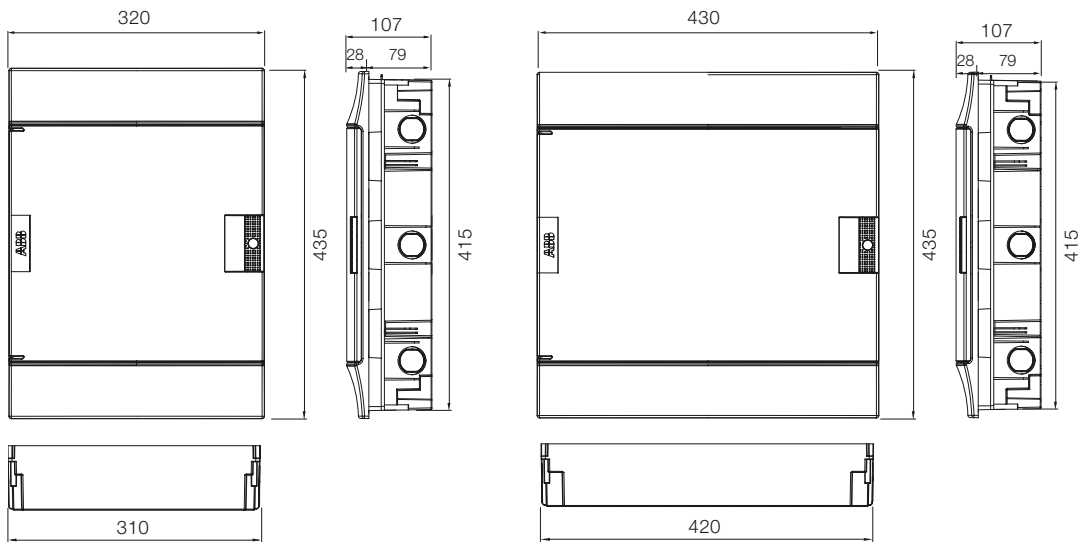

24 modules

36 modules

Quick product references

Overall dimensions

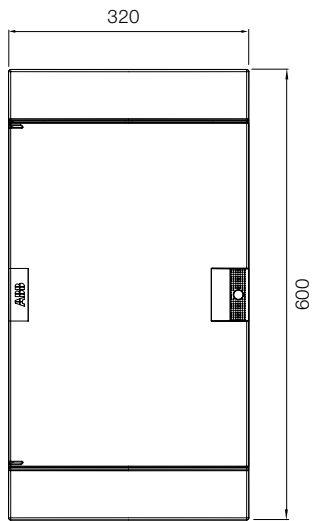

36 modules

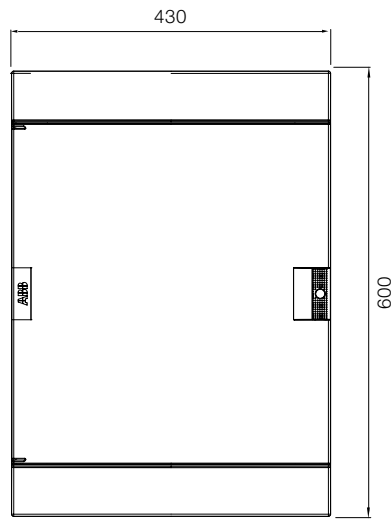

54 modules

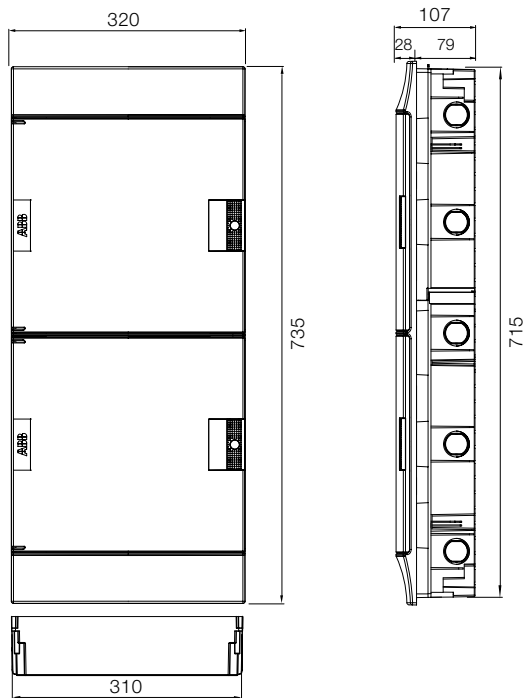

48 modules

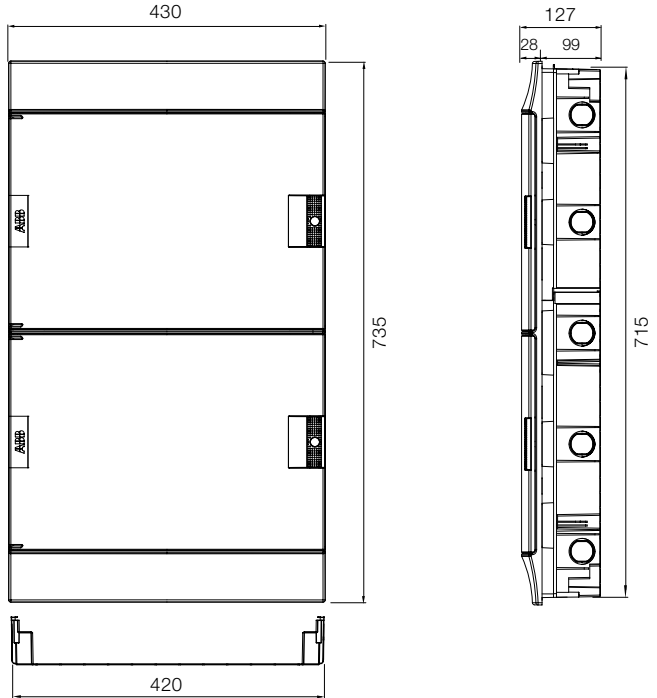

72 modules

Quick product references

Overall dimensions

System pro E comfort MISTRAL41W

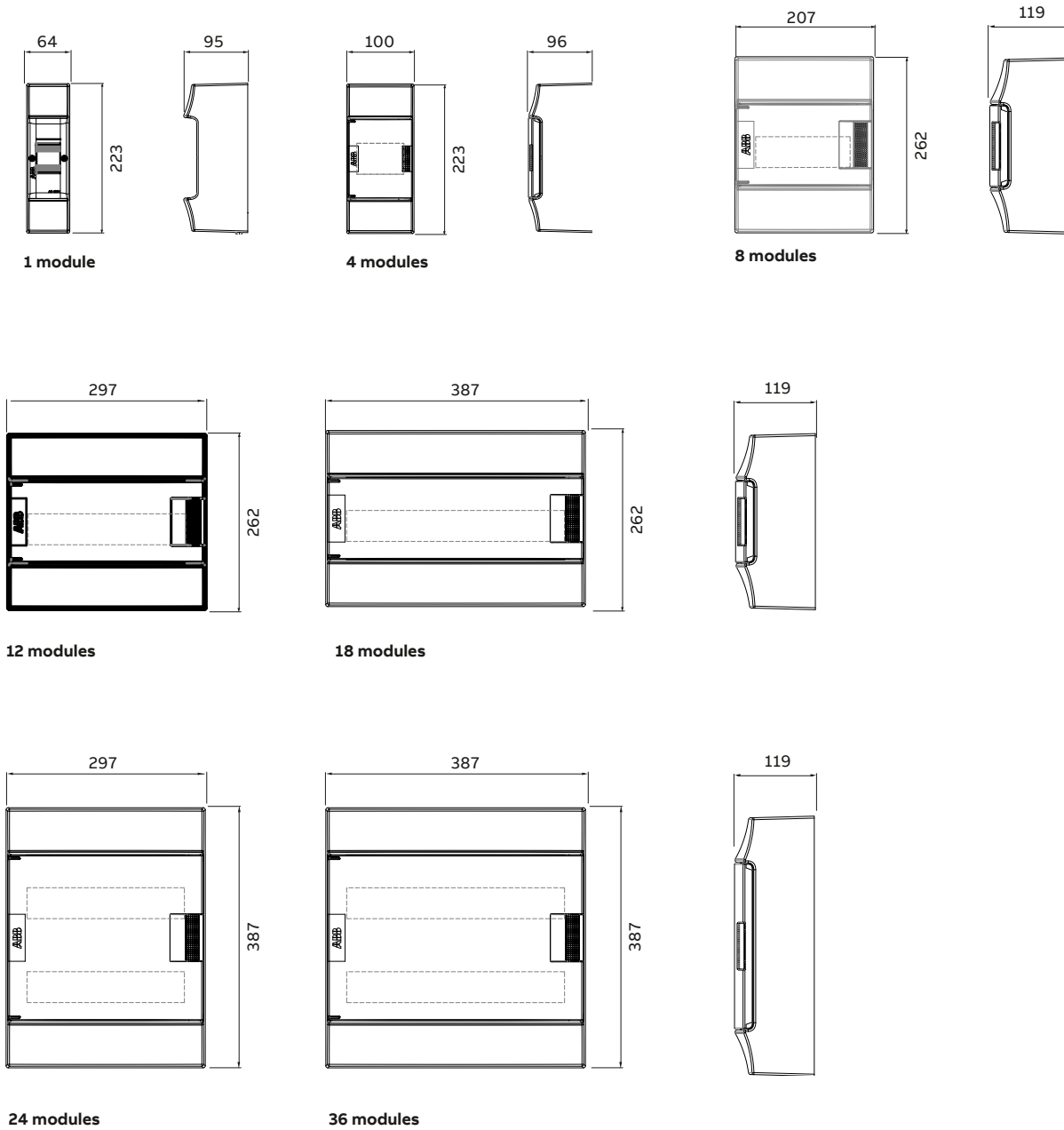

Quick product references

Overall dimensions

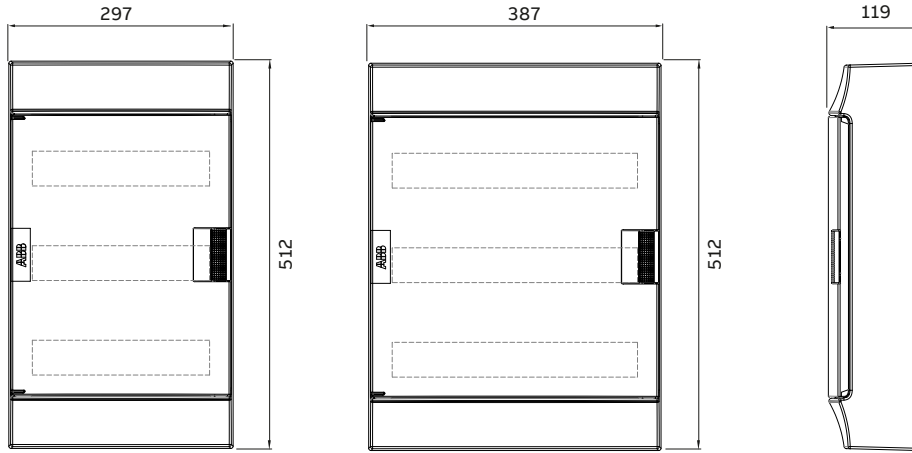

36 modules

54 modules

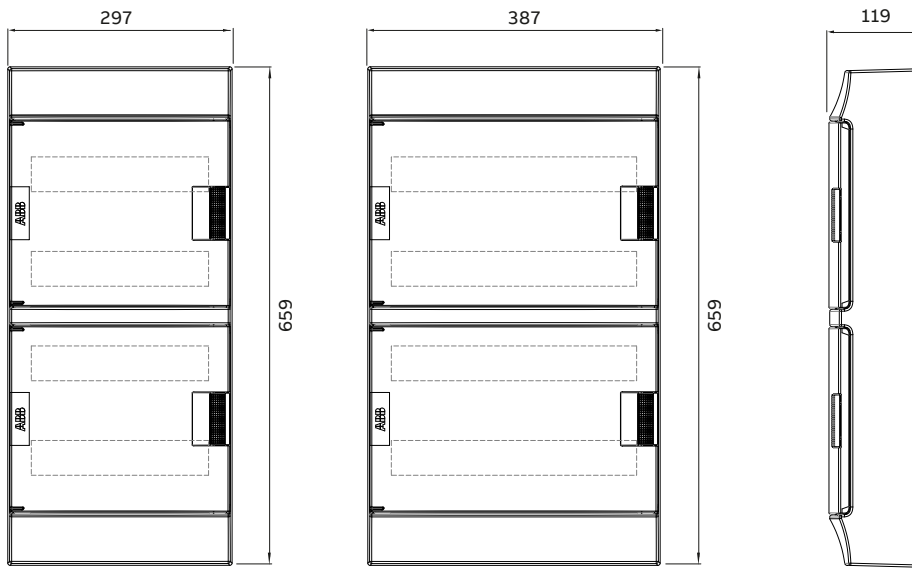

48 modules

72 modules

Quick product references

Overall dimensions

System pro E comfort MISTRAL41W

Consumer unit fixing template System pro E comfort MISTRAL41W

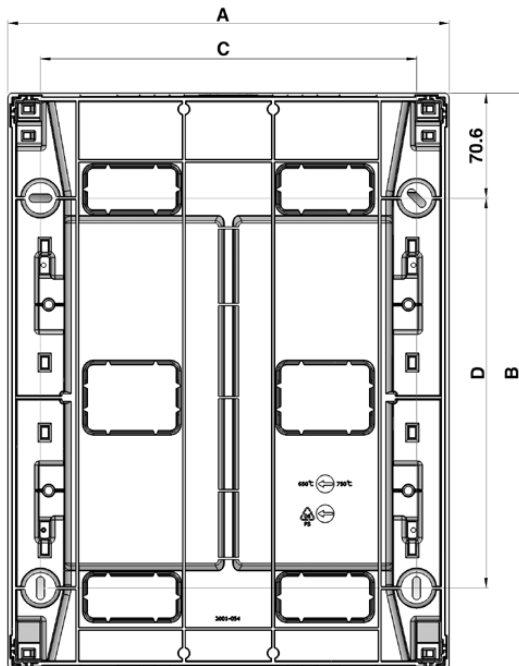

	A	B	C	D
8 Modules	206,5	262	163	137
12 Modules	297	262	253	137
18 Modules	387	262	343	137
24 Modules	297	387	253	262
36 Modules 18x2	387	387	343	262
36 Modules 12x3	297	512	253	387
48 Modules	297	659	253	518
54 Modules	387	512	343	387
72 Modules	387	659	343	518

Quick product references

Overall dimensions

System pro E comfort MISTRAL65

Cable gland table

Cable Glands				
Modules		diam. 16	diam. 20	diam. 25
4	04x1	2	-	-
8	08x1	3	3	-
12	12x1	2	2	2
24	12x2	5	5	2
36	12x3	5	5	2
48	12x4	5	5	2
18	18x1	2	2	2
36	18x2	5	5	2
54	18x3	5	5	2
72	18x4	5	5	2

Holes						
Modules		diam. 12	diam. 16	diam. 20	diam. 25	diam. 32
4	04x1	4	4	-	-	-
8	08x1	-	6	7	2	-
12	12x1	-	10	7	4	2
24	12x2	-	10	7	4	2
36	12x3	-	10	7	4	2
48	12x4	-	10	7	4	2
18	18x1	-	14	9	4	2
36	18x2	-	14	9	4	2
54	18x3	-	14	9	4	2
72	18x4	-	14	9	4	2

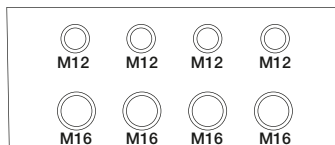

4 modules - top and bottom

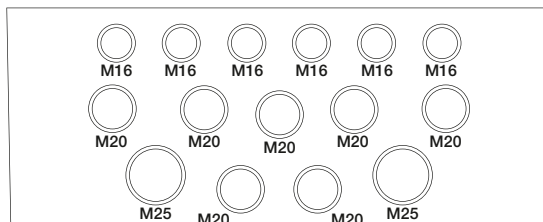

8 modules - top and bottom

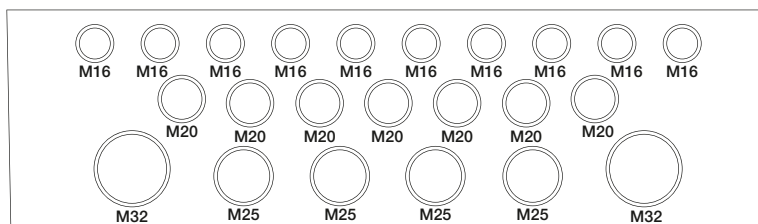

12 modules - top and bottom

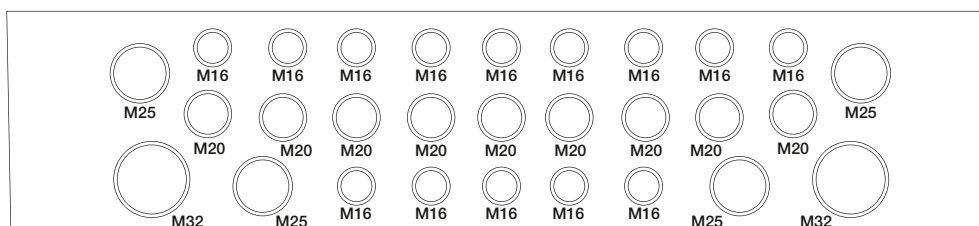

18 modules - top and bottom

Quick product references

Overall dimensions

System pro E comfort MISTRAL65

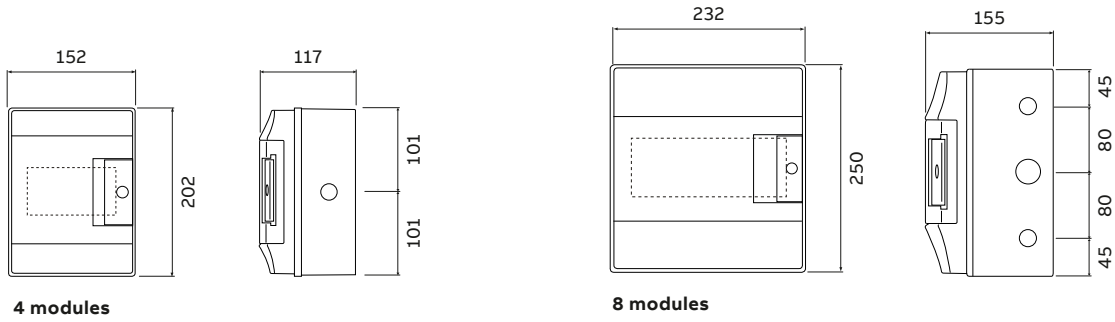

4 modules

8 modules

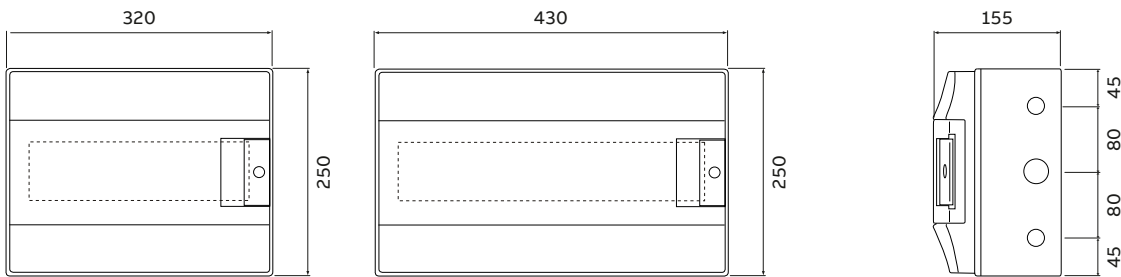

12 modules

18 modules

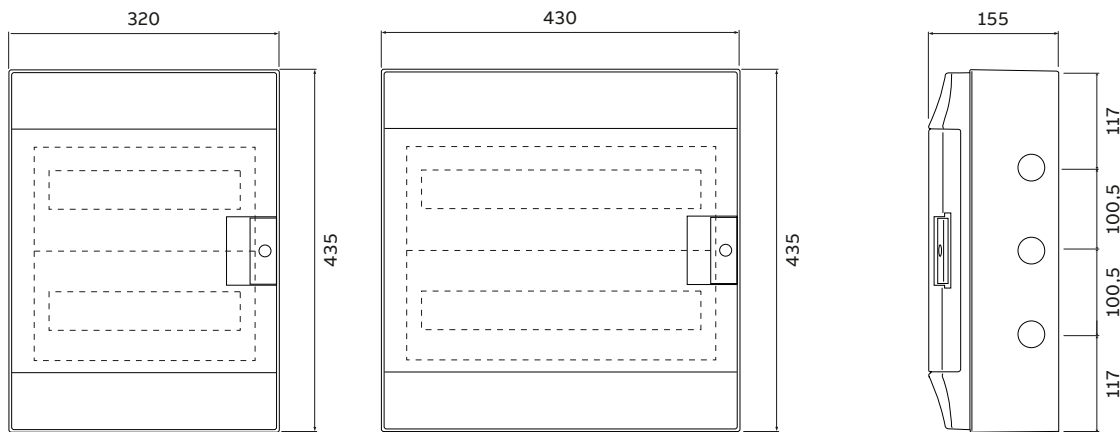

24 modules

36 modules

Quick product references

Overall dimensions

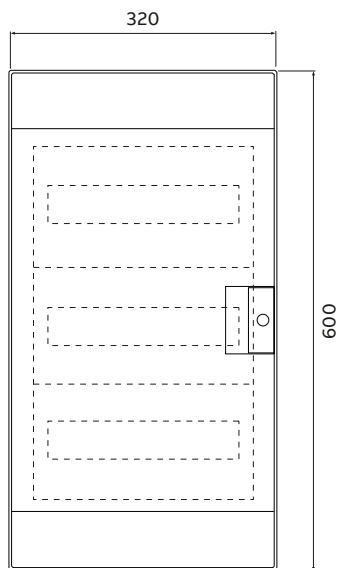

36 modules

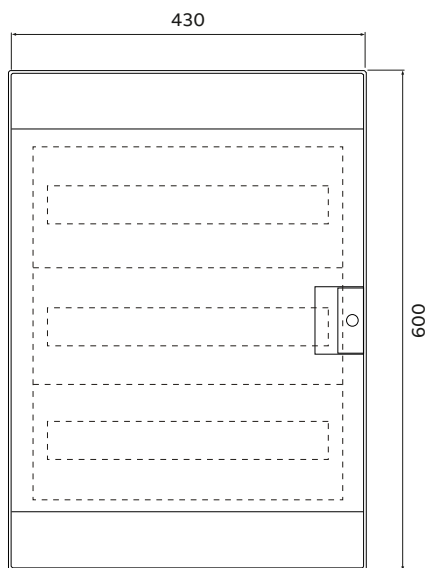

54 modules

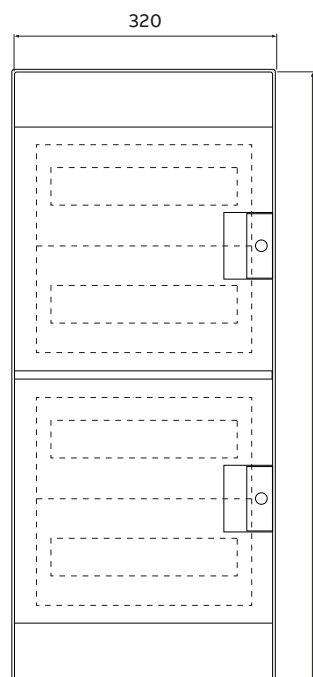
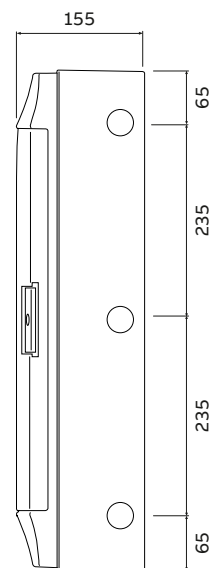

48 modules

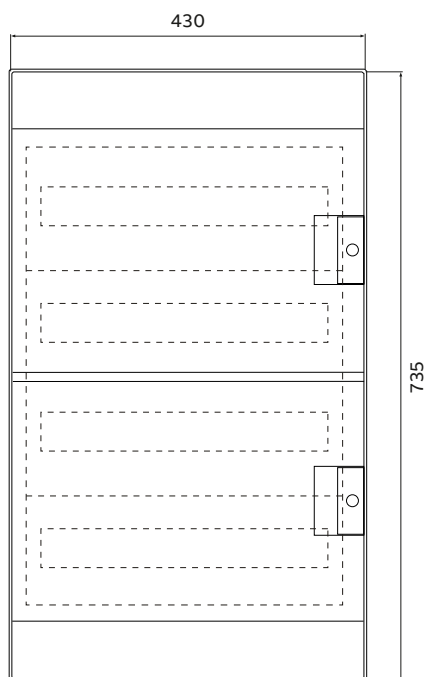

72 modules

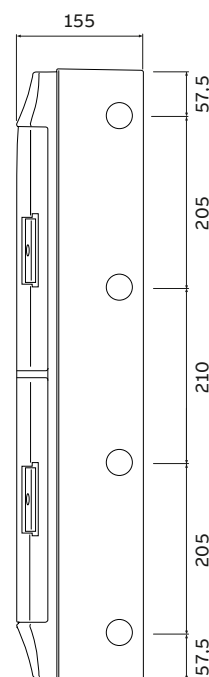

Quick product references

Overall dimensions

System pro E comfort MISTRAL65

Consumer unit fixing template

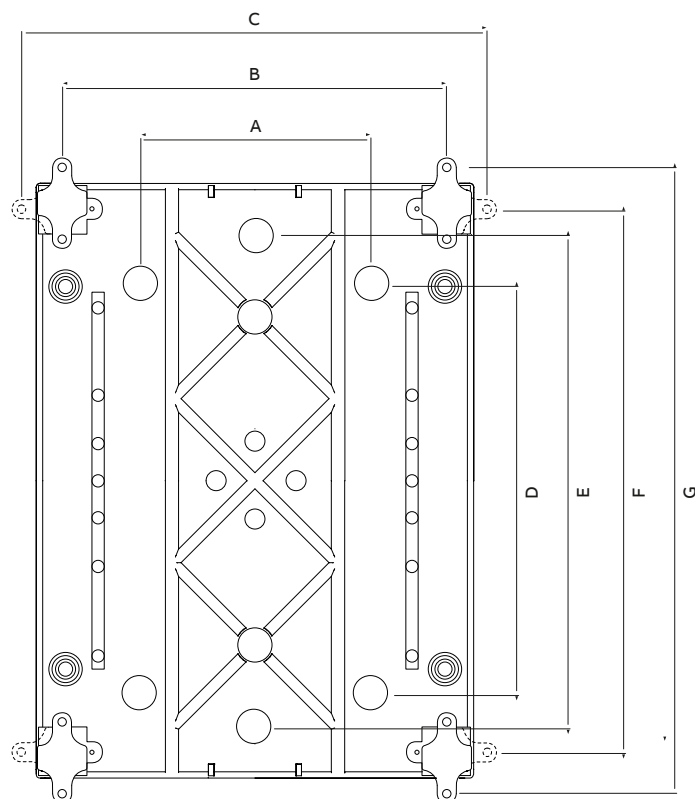

	A	B	C	D	E	F	G
4 Modules		113	173		140	163	223,5
8 Modules	90	194	254,5	180		212	272,5
12 Modules	170	282,5	343	180		212	272,5
18 Modules	280	392	452,5	125	175	212	272,5
24 Modules	170	282,5	343	310	360	397	457,5
36 Modules - 2 F	280	392	452,5	310	360	397	457,5
36 Modules - 3 F	170	282,5	343	475	525	562	622,5
48 Modules	170	282,5	343	610	660	697	757,5
54 Modules	280	392	452,5	475	525	562	622,5
72 Modules	280	392	452,5	610	660	697	757,5

Quick product references

Overall dimensions

AT/U Series

Wall-mounting with door, AT series

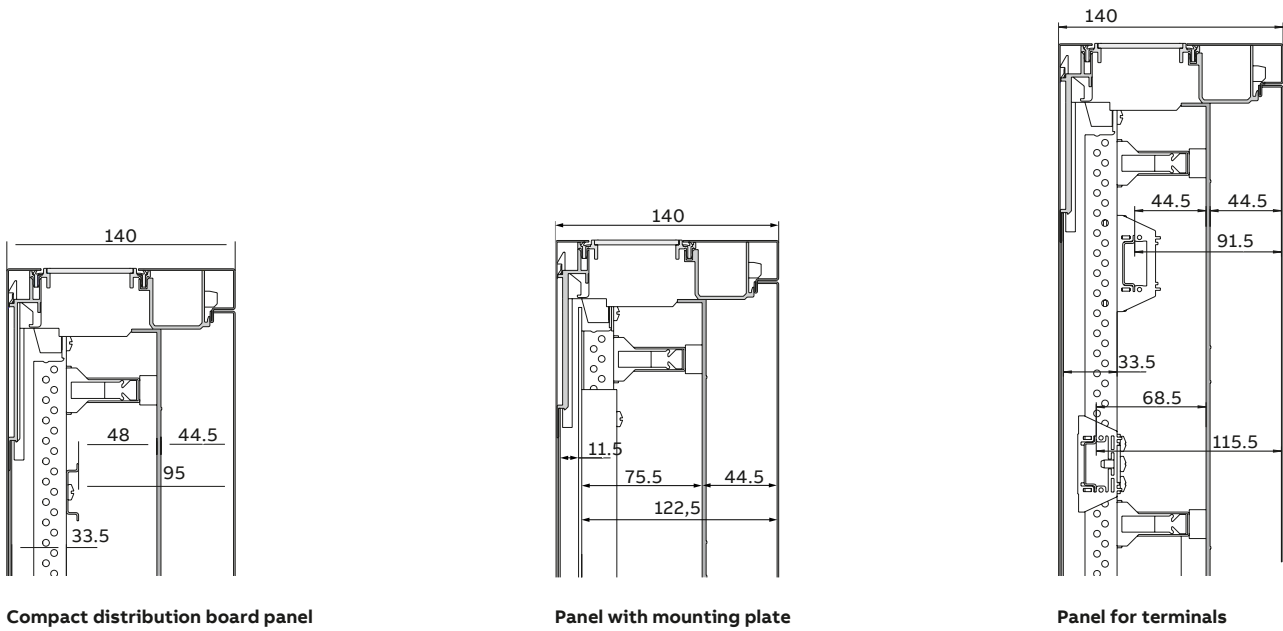

Compact distribution board panel

Panel with mounting plate

Panel for terminals

Flush-mounting with door, U series

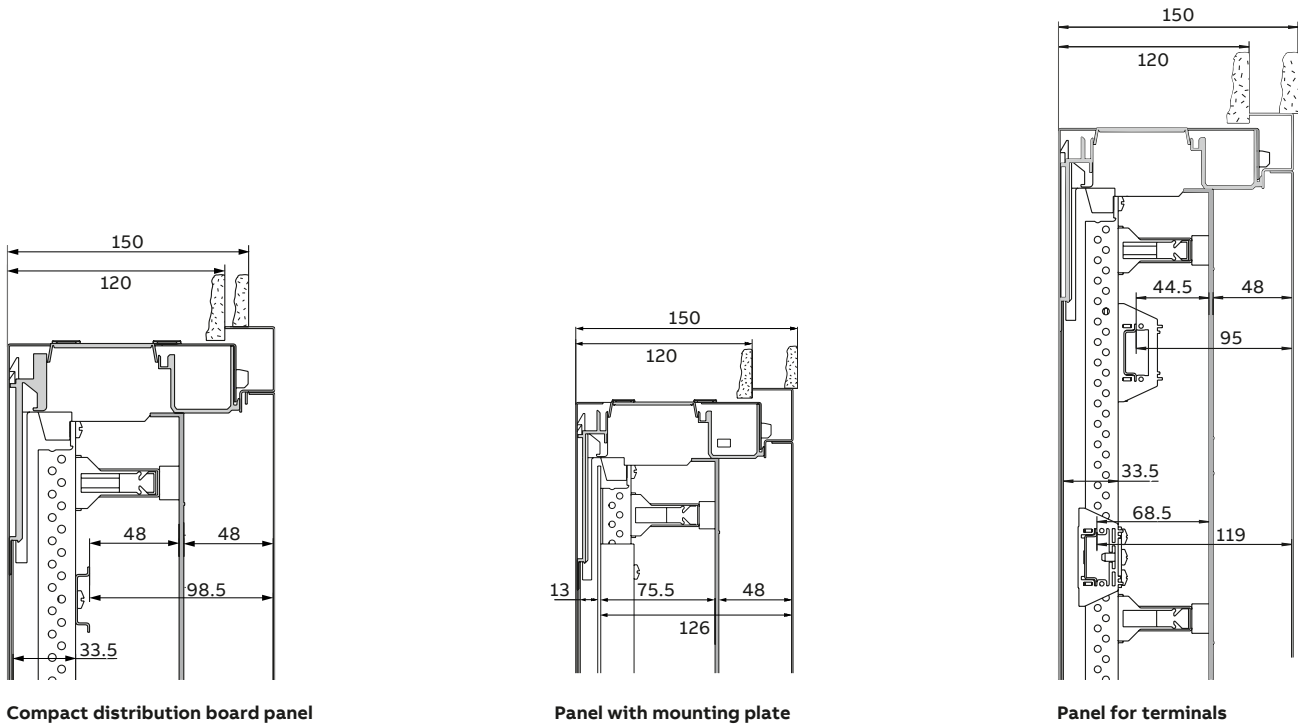

Compact distribution board panel

Panel with mounting plate

Panel for terminals

Quick product references

Overall dimensions

Compact distribution boards

Type	H	W	H1	W1
AT22E	374	574	235	417
AT31	524	324	385	167
AT32, AT32TE, AT32R2, AT32TR2	524	574	385	417
AT41, AT41TE, AT41R3, AT41TR3	674	324	535	167
AT42, AT42TE, AT42M, AT42/2, AT42R3, AT42TR3	674	574	535	417
AT43, AT43R3, AT43TR3	674	824	535	667
AT51, AT51TE, AT51R4, AT51TR4	824	324	685	167
AT52, AT52TE, AT52K, AT52/2, AT52R4, AT52TR4	824	574	685	417
AT53, AT53M, AT53K, AT53R4, AT53TR4	824	824	685	667
AT54K, AK54E, AT54R4	824	1074	685	917
AT61, AT61TE, AT61R5, AT61TR5	974	324	835	167
AT62, AT62TE, AT62K, AT62R5, AT62TR5	974	574	835	417
AT63E, AT63K, AT63R5, AT63TR5	974	824	835	667
AT64K	974	1074	835	917
AT72, AT72K, AT72R6, AT72TR6	1124	574	985	417
AT73K, AT73R6, AT73TR6	1124	824	985	667

Dimensions in mm

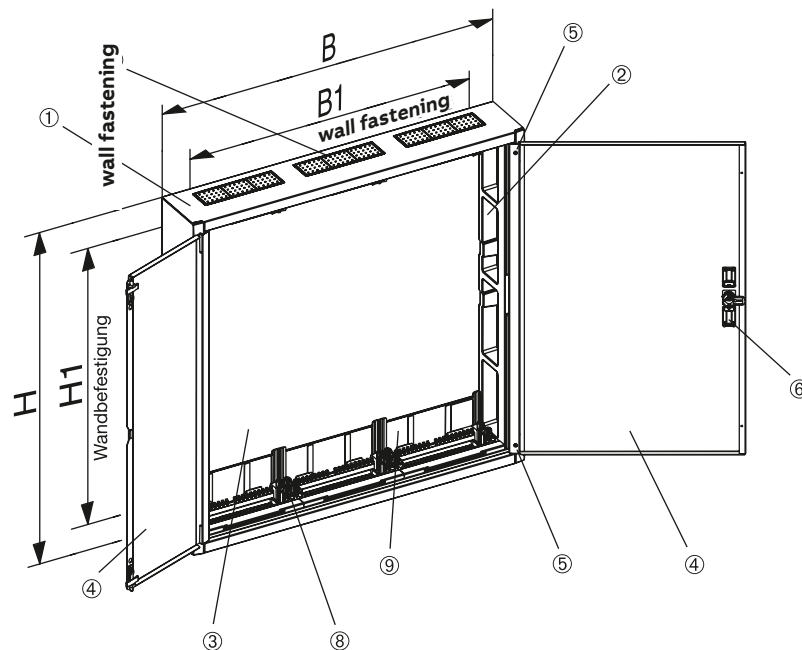

Quick product references

Overall dimensions

Terminal blocks for MISTRAL series

Terminal holders – dimensions

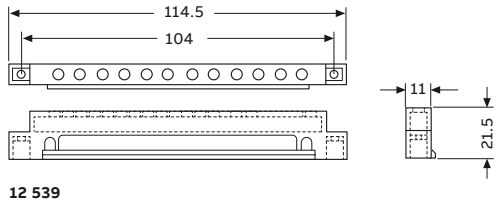

12 539

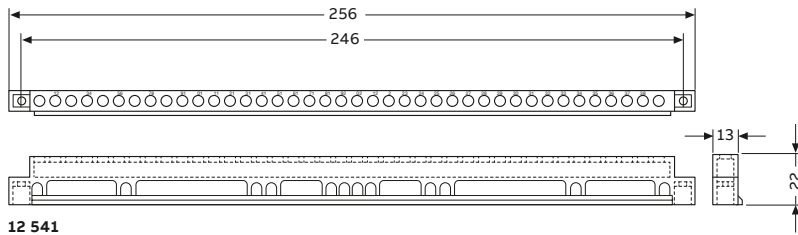

12 541

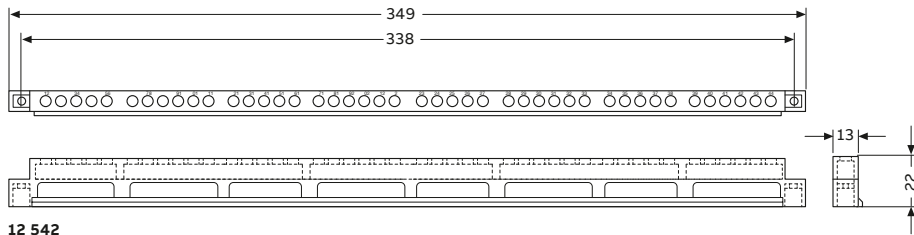

12 542

Quick product references

Overall dimensions

Terminal blocks for MISTRAL series

Terminal bars – dimensions

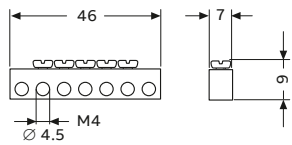

12 531

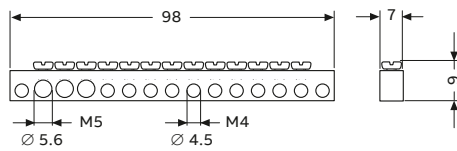

12 532

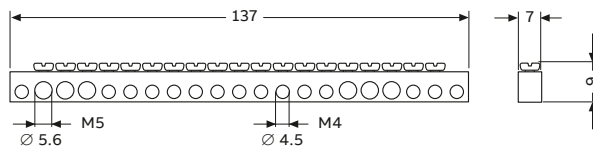

12 533

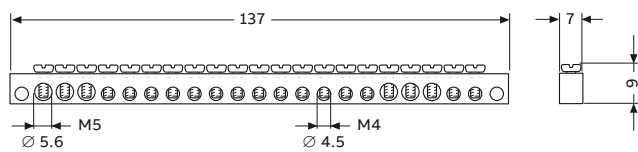

12 534

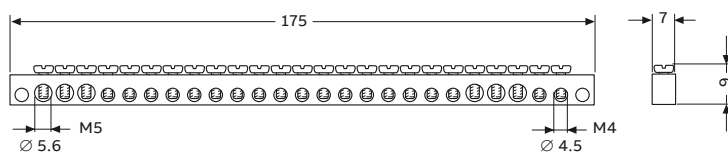

12 535

Quick product references

Overall dimensions

EUROPA65 Series wall-mounting consumer units

Front view

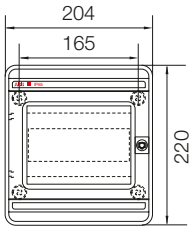

8 modules

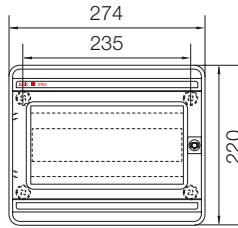

12 modules

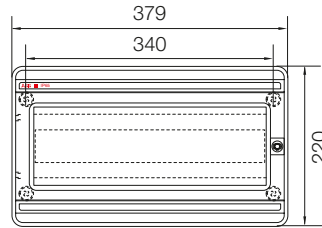

18 modules

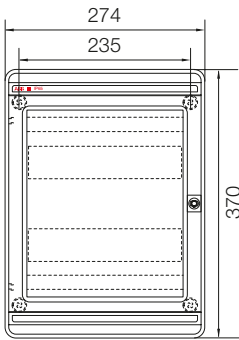

24 modules

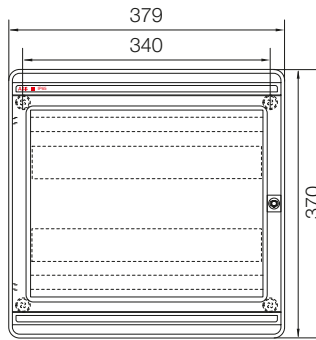

36 modules

Side view

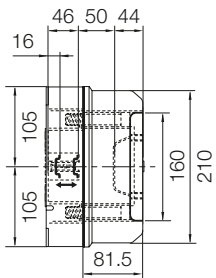

8 - 12 modules

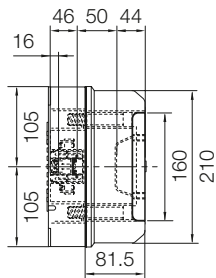

18 modules

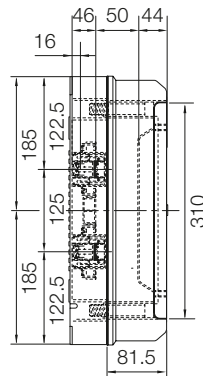

24 -36 modules

Dimensions mm

Quick product references

Overall dimensions

EUROPA65 Series wall-mounting consumer units

Drilling sheets

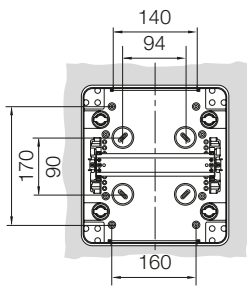

8 modules

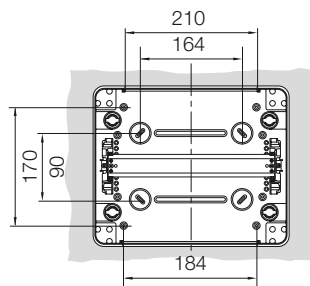

12 modules

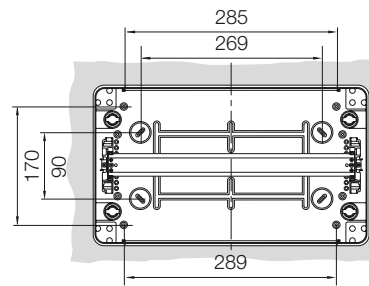

18 modules

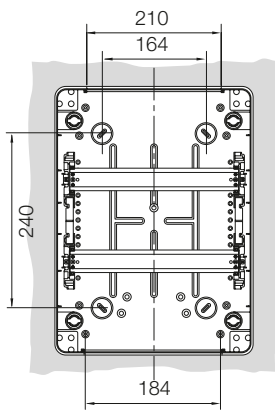

24 modules

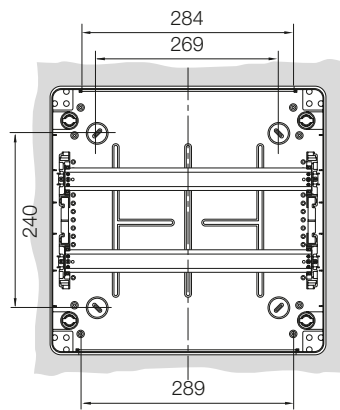

36 modules

Modules	Code
8	1SL2748A01
12	1SL2752A01
18	1SL2753A01
24	1SL2754A01
36	1SL2755A01

Quick product references

Overall dimensions

IP44, IP55 and IP65 junction boxes

Front view

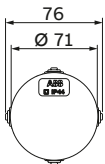

00 800
1SL0900A00

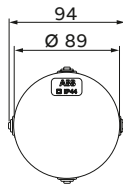

00 802
1SL0901A00

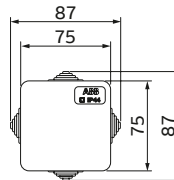

00 808
1SL0902A00

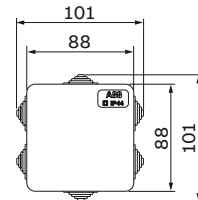

00 810
1SL0903A00

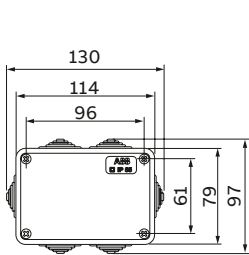

00 820
00 850
1SL0820A00
1SL0850A00
1SL0905A00
1SL0909A00
1SL0920A00
1SL0950A00

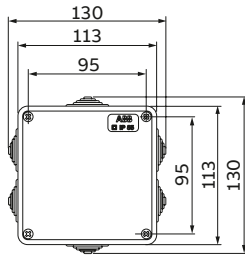

00 816
00 821
00 846
00 851
1SL0816A00
1SL0821A00
1SL0846A00
1SL0851A00

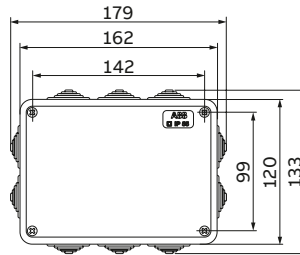

00 822
00 852
00 872
1SL0822A00
1SL0852A00
1SL0872A00

1SL0904A00
1SL0906A00
1SL0908A00
1SL0910A00
1SL0916A00
1SL0921A00
1SL0946A00
1SL0951A00

1SL0907A00
1SL0911A00
1SL0912A00
1SL0922A00
1SL0972A00
1SL0985A00

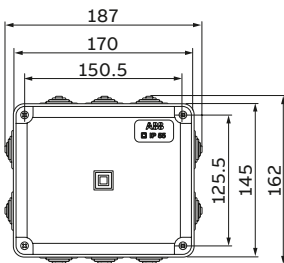

1SL0824A00
1SL0830A00
1SL0854A00
1SL0860A00
1SL0874A00
1SL0880A00

1SL0924A00
1SL0930A00
1SL0954A00
1SL0960A00
1SL0974A00
1SL0980A00

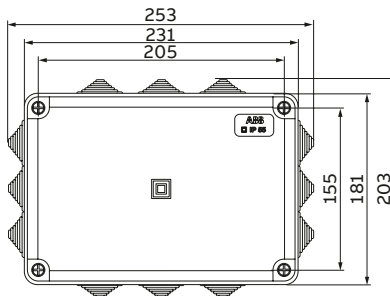

1SL0826A00
1SL0832A00
1SL0856A00
1SL0862A00
1SL0876A00
1SL0884A00

1SL0926A00
1SL0932A00
1SL0956A00
1SL0962A00
1SL0976A00
1SL0984A00

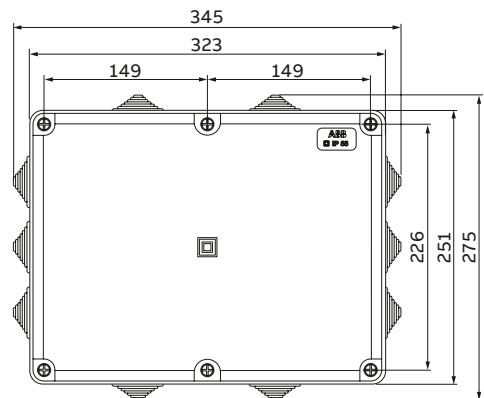

1SL0828A00
1SL0834A00
1SL0858A00
1SL0864A00
1SL0878A00
1SL0884A00

1SL0928A00
1SL0934A00
1SL0958A00
1SL0964A00
1SL0978A00
1SL0984A00

Quick product references

Overall dimensions

IP44, IP55 and IP65 junction boxes

Side view

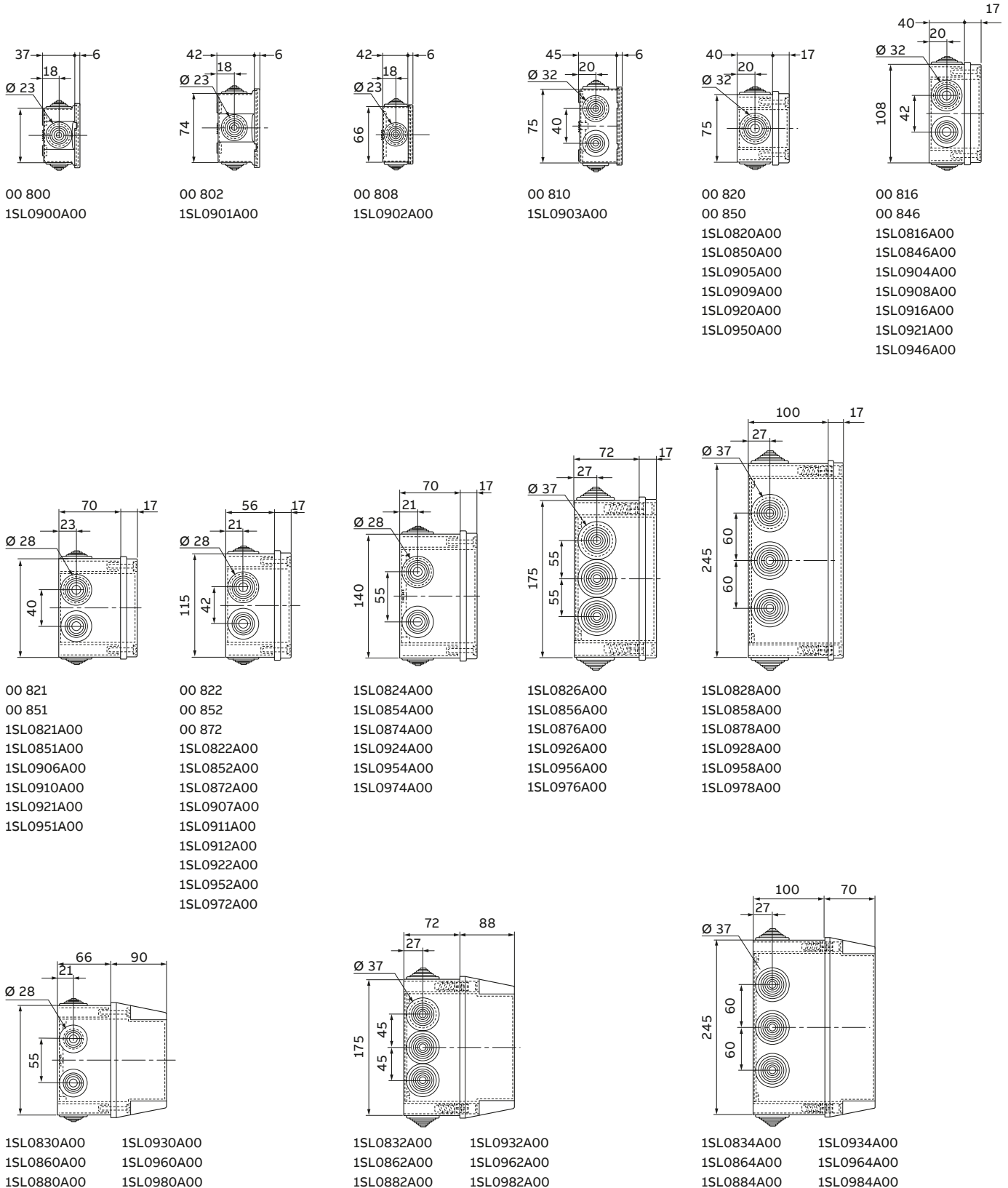

Quick product references

Overall dimensions

Drilling sheets and internal dimensions

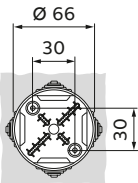

00 800
00 581
1SL0900A00
1SL0910A00

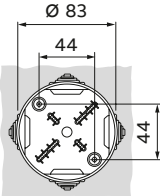

00 802
1SL0901A00

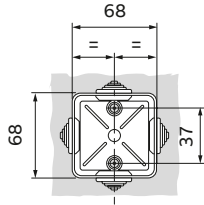

00 808
1SL0902A00

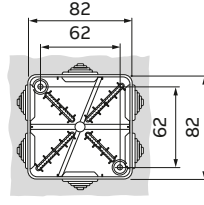

00 810
1SL0903A00

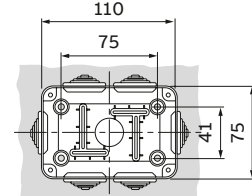

00 820
00 850
1SL0820A00
1SL0850A00

1SL0905A00
1SL0909A00
1SL0920A00
1SL0950A00

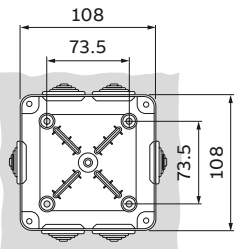

00 816
00 846
1SL0816A00
1SL0846A00

1SL0904A00
1SL0908A00
1SL0916A00
1SL0946A00

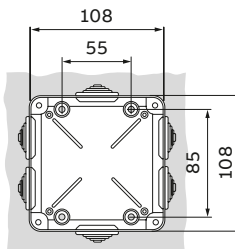

00 821
00 851
1SL0821A00
1SL0851A00

1SL0906A00
1SL0910A00
1SL0921A00
1SL0951A00

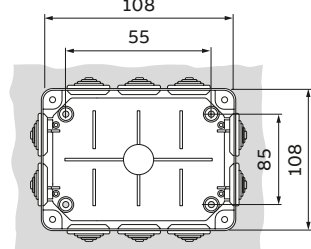

00 822
00 852
00 872
1SL0822A00
1SL0852A00
1SL0872A00

1SL0907A00
1SL0911A00
1SL0912A00
1SL0922A00
1SL0952A00
1SL0972A00

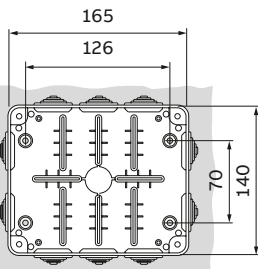

1SL0830A00
1SL0824A00
1SL0874A00
1SL0854A00
1SL0860A00
1SL0880A00

1SL0924A00
1SL0930A00
1SL0954A00
1SL0960A00
1SL0974A00
1SL0980A00

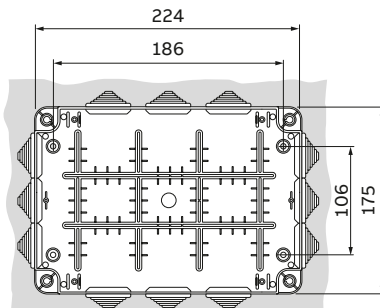

1SL0826A00
1SL0832A00
1SL0876A00
1SL0856A00
1SL0862A00
1SL0884A00

1SL0926A00
1SL0932A00
1SL0956A00
1SL0962A00
1SL0976A00
1SL0984A00

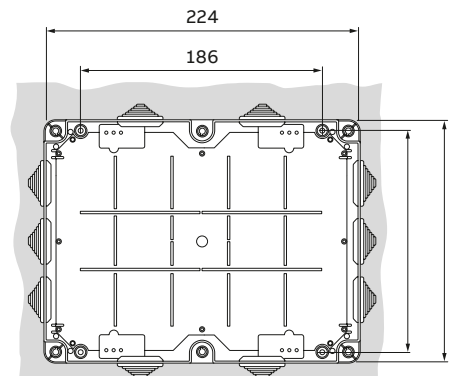

1SL0828A00
1SL0834A00
1SL0878A00
1SL0858A00
1SL0864A00
1SL0884A00

1SL0928A00
1SL0934A00
1SL0958A00
1SL0964A00
1SL0978A00
1SL0984A00

Quick product references

Overall dimensions

TwinLine S 43

Front view
Wall-mounting and
floor-standing cabinet
External/internal dimensions

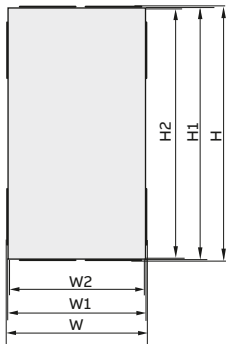

Front view
Wall-mounting cabinet
Wall fastening dimensions

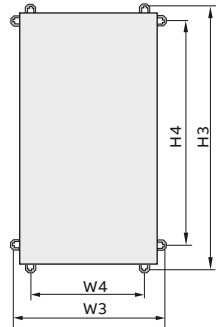

Front view
Floor-standing cabinet
Wall fastening dimensions

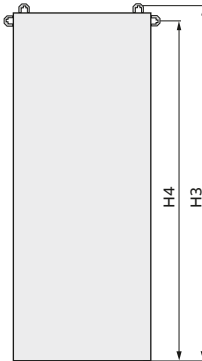

Front view
External fastening
Detail

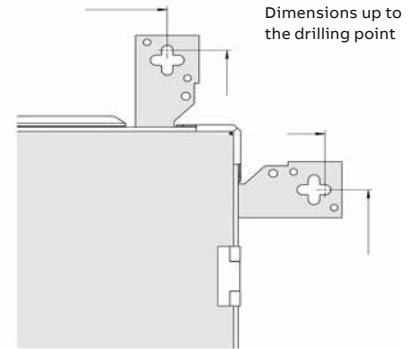

Cabinet types H x W x D	External dimensions in mm			Internal dimensions in mm		External dimensions with embossing in mm		Wall fastening dimensions in mm			
	H1	W1	D1	H2	W2	H	W	H3	W3	H4	W4
400 x 300 x 225	450	390	225	402	342	454	394	578.5	518.5	345	285
600 x 300 x 225	650	390	225	602	342	654	394	778.5	518.5	545	285
800 x 300 x 225	850	390	225	802	342	854	394	978.5	518.5	745	285
1000 x 300 x 225	1050	390	225	1002	342	1054	394	1178.5	518.5	945	285
1200 x 300 x 225	1250	390	225	1202	342	1254	394	1378.5	518.5	1145	285
1400 x 300 x 225	1450	390	225	1402	342	1454	394	1514	518.5	1292.5	285
1600 x 300 x 225	1650	390	225	1602	342	1654	394	1714	518.5	1492.5	285
1800 x 300 x 225	1850	390	225	1802	342	1854	394	1914	518.5	1692.5	285
2000 x 300 x 225	2050	390	225	2002	342	2054	394	2114	518.5	1892.5	285
400 x 600 x 225	450	660	225	402	612	454	664	578.5	788.5	345	555
600 x 600 x 225	650	660	225	602	612	654	664	778.5	788.5	545	555
800 x 600 x 225	850	660	225	802	612	854	664	978.5	788.5	745	555
1000 x 600 x 225	1050	660	225	1002	612	1054	664	1178.5	788.5	945	555
1200 x 600 x 225	1250	660	225	1202	612	1254	664	1378.5	788.5	1145	555
1400 x 600 x 225	1450	660	225	1402	612	1454	664	1514	788.5	1292.5	555
1600 x 600 x 225	1650	660	225	1602	612	1654	664	1714	788.5	1492.5	555
1800 x 600 x 225	1850	660	225	1802	612	1854	664	1914	788.5	1692.5	555
2000 x 600 x 225	2050	660	225	2002	612	2054	664	2114	788.5	1892.5	555
400 x 800 x 225	450	875	225	402	827	454	879	578.5	1003.5	345	770
600 x 800 x 225	650	875	225	602	827	654	879	778.5	1003.5	545	770
800 x 800 x 225	850	875	225	802	827	854	879	978.5	1003.5	745	770
1000 x 800 x 225	1050	875	225	1002	827	1054	879	1178.5	1003.5	945	770
1200 x 800 x 225	1250	875	225	1202	827	1254	879	1378.5	1003.5	1145	770
1400 x 800 x 225	1450	875	225	1402	827	1454	879	1514	1003.5	1292.5	770
1600 x 800 x 225	1650	875	225	1602	827	1654	879	1714	1003.5	1492.5	770
1800 x 800 x 225	1850	875	225	1802	827	1854	879	1914	1003.5	1692.5	770
2000 x 800 x 225	2050	875	225	2002	827	2054	879	2114	1003.5	1892.5	770

Quick product references

Overall dimensions

TwinLine S 43

Front view
Wall-mounting and floor-standing cabinet
External/internal dimensions

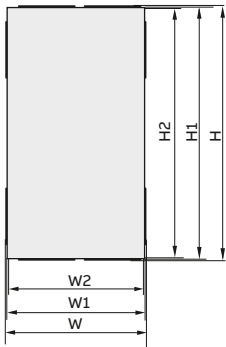

Front view
Wall-mounting cabinet
Wall fastening dimensions

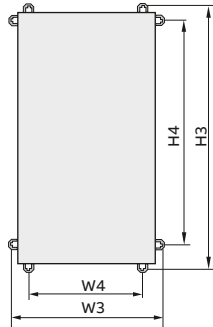

Front view
Floor-standing cabinet
Wall fastening dimensions

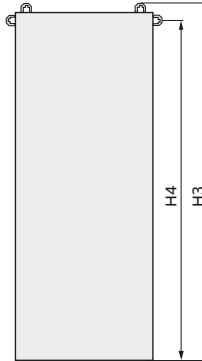

Front view
External fastening
Detail

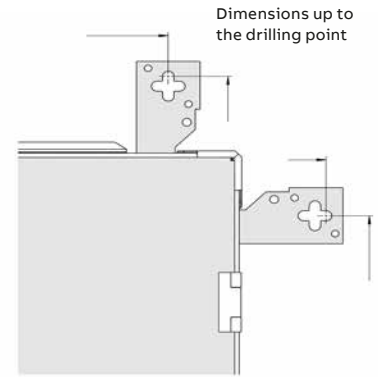

Cabinet types H x W x D	External dimensions in mm			Internal dimensions in mm		External dimensions with embossing in mm		Wall fastening dimensions in mm			
	H1	W1	D1	H2	W2	H	W	H3	W3	H4	W4
400 x 300 x 275	450	390	275	402	342	454	394	578.5	518.5	345	285
600 x 300 x 275	650	390	275	602	342	654	394	778.5	518.5	545	285
800 x 300 x 275	850	390	275	802	342	854	394	978.5	518.5	745	285
1000 x 300 x 275	1050	390	275	1002	342	1054	394	1178.5	518.5	945	285
1200 x 300 x 275	1250	390	275	1202	342	1254	394	1378.5	518.5	1145	285
1400 x 300 x 275	1450	390	275	1402	342	1454	394	1514	518.5	1292.5	285
1600 x 300 x 275	1650	390	275	1602	342	1654	394	1714	518.5	1492.5	285
1800 x 300 x 275	1850	390	275	1802	342	1854	394	1914	518.5	1692.5	285
2000 x 300 x 275	2050	390	275	2002	342	2054	394	2114	518.5	1892.5	285
400 x 600 x 275	450	660	275	402	612	454	664	578.5	788.5	345	555
600 x 600 x 275	650	660	275	602	612	654	664	778.5	788.5	545	555
800 x 600 x 275	850	660	275	802	612	854	664	978.5	788.5	745	555
1000 x 600 x 275	1050	660	275	1002	612	1054	664	1178.5	788.5	945	555
1200 x 600 x 275	1250	660	275	1202	612	1254	664	1378.5	788.5	1145	555
1400 x 600 x 275	1450	660	275	1402	612	1454	664	1514	788.5	1292.5	555
1600 x 600 x 275	1650	660	275	1602	612	1654	664	1714	788.5	1492.5	555
1800 x 600 x 275	1850	660	275	1802	612	1854	664	1914	788.5	1692.5	555
2000 x 600 x 275	2050	660	275	2002	612	2054	664	2114	788.5	1892.5	555
400 x 800 x 275	450	875	275	402	827	454	879	578.5	1003.5	345	770
600 x 800 x 275	650	875	275	602	827	654	879	778.5	1003.5	545	770
800 x 800 x 275	850	875	275	802	827	854	879	978.5	1003.5	745	770
1000 x 800 x 275	1050	875	275	1002	827	1054	879	1178.5	1003.5	945	770
1200 x 800 x 275	1250	875	275	1202	827	1254	879	1378.5	1003.5	1145	770
1400 x 800 x 275	1450	875	275	1402	827	1454	879	1514	1003.5	1292.5	770
1600 x 800 x 275	1650	875	275	1602	827	1654	879	1714	1003.5	1492.5	770
1800 x 800 x 275	1850	875	275	1802	827	1854	879	1914	1003.5	1692.5	770
2000 x 800 x 275	2050	875	275	2002	827	2054	879	2114	1003.5	1892.5	770

Quick product references

Overall dimensions

TwinLine S 43

External dimensions

Dimensions of usable connection area

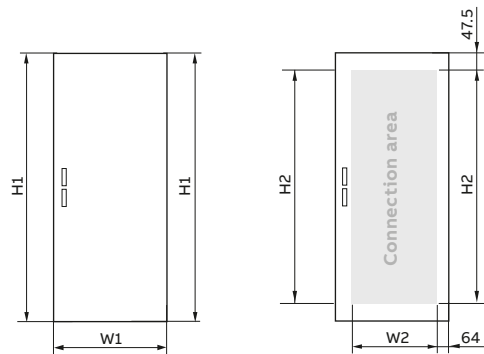

Sheet steel doors Type	External dimensions Height x width in mm		Internal dimensions Height x width in mm		Weight in kg	max. installation weight in kg
	H1	W1	H2	W2		
ESAS0304	443	379	348	213	4.75	5
ESAS0306	643	379	548	213	6.62	5
ESAS0308	843	379	748	213	7.81	5
ESAS0310	1043	379	948	213	9.72	5
ESAS0312	1243	379	1148	213	11.49	5
ESAS0314	1443	379	1348	213	13.50	5
ESAS0316	1643	379	1548	213	15.05	5
ESAS0318	1843	379	1748	213	16.58	5
ESAS0320	2043	379	1948	213	18.14	5
<hr/>						
ESAS0604	443	649	348	483	6.95	5
ESAS0606	643	649	548	483	9.46	5
ESAS0608	843	649	748	483	11.64	5
ESAS0610	1043	649	948	483	13.83	5
ESAS0612	1243	649	1148	483	16.24	5
ESAS0614	1443	649	1348	483	18.88	5
ESAS0616	1643	649	1548	483	21.07	5
ESAS0618	1843	649	1748	483	23.25	5
ESAS0620	2043	649	1948	483	25.43	5
<hr/>						
ESAS0804	443	864	348	698	8.70	7.5
ESAS0806	643	864	548	698	11.72	7.5
ESAS0808	843	864	748	698	14.41	7.5
ESAS0810	1043	864	948	698	17.10	7.5
ESAS0810	1243	864	1148	698	20.02	7.5
ESAS0814	1443	864	1348	698	23.17	7.5
ESAS0816	1643	864	1548	698	25.86	7.5
ESAS0818	1843	864	1748	698	28.54	7.5
ESAS0820	2043	864	1948	698	31.23	7.5

Quick product references

Overall dimensions

TwinLine S 43

External dimensions

Dimensions of viewing area

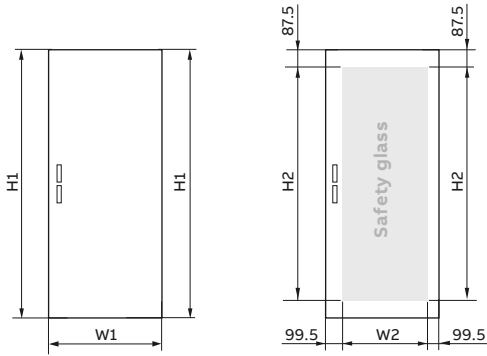

Transparent doors Type	External dimensions Height x width in mm		Viewing area Height x width in mm		Weight in kg
	H1	W1	H2	W2	
ESAT0606	643	649	468	450	9.63
ESAT0608	843	649	668	450	11.67
ESAT0610	1043	649	868	450	13.7
ESAT0612	1243	649	1068	450	15.96
ESAT0614	1443	649	1268	450	18.36
ESAT0616	1643	649	1468	450	20.4
ESAT0618	1843	649	1668	450	22.43
ESAT0620	2043	649	1868	450	24.46
ESAT0806	643	864	468	665	11.85
ESAT0808	843	864	668	665	14.3
ESAT0810	1043	864	868	665	16.74
ESAT0812	1243	864	1068	665	19.4
ESAT0814	1443	864	1268	665	22.23
ESAT0816	1643	864	1468	665	24.67
ESAT0818	1843	864	1668	665	27.12
ESAT0820	2043	864	1868	665	29.56
ESAT2606	643	864	468	450	11.66
ESAT2608	843	864	668	450	14.2
ESAT2610	1043	864	868	450	16.47
ESAT2612	1243	864	1068	450	19.5
ESAT2614	1443	864	1268	450	22.42
ESAT2616	1643	864	1468	450	24.96
ESAT2618	1843	864	1668	450	27.5
ESAT2620	2043	864	1868	450	30

Quick product references

Overall dimensions

TwinLine S 43 mounting plate

External dimensions / Usable connection area
Mounting plate

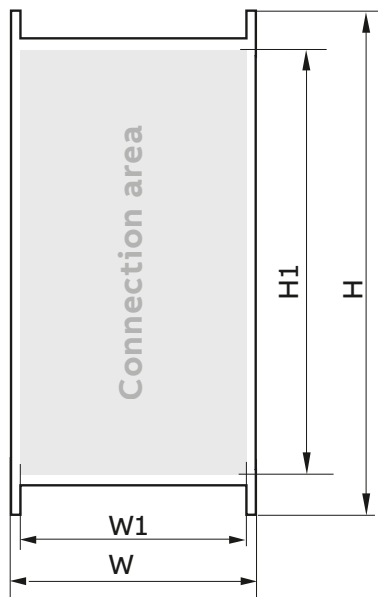

Type	External dimensions Width x depth in mm		Internal dimensions Width x depth in mm		Weight in kg
	H	W	H1	W1	
TZM204	600	496	522	410	3.51
TZM304	600	746	522	660	8.07
TZM208	1200	496	1122	410	11.82
TZM308	1200	746	1122	660	16.45
RM28	1800	496	1722	410	17.8
RM38	1800	746	1722	660	21

Quick product references

Overall dimensions

TwinLine S 43 plinth

External/internal dimensions

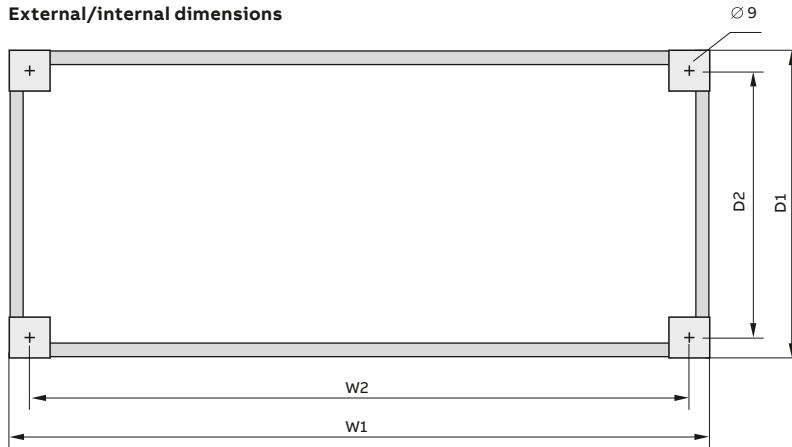

Detail view for side knockout

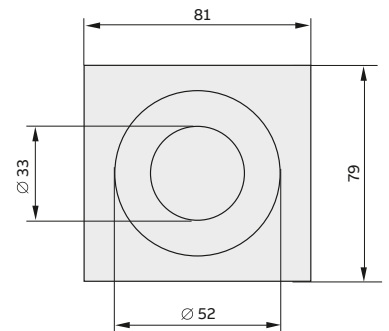

View side knockout TwinLine-G and -L

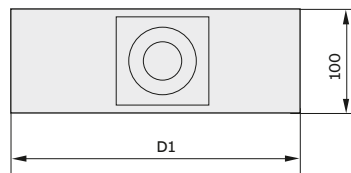
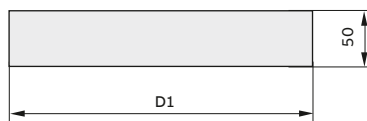

Type	External dimensions Width x depth in mm		Internal dimensions Width x depth in mm		Weight in kg
	W1	D1	W2	D2	
Plinth height 50mm					
ESAL0305	390	253.5	360	223.5	1.57
ESAL0605	660	253.5	630	223.5	2.10
ESAL0805	875	253.5	845	223.5	2.53
ESAG0305	390	203.5	360	173.5	1.44
ESAG0605	660	203.5	630	173.5	1.98
ESAG0805	875	203.5	845	173.5	2.41
Plinth height 100mm					
ESAL0310	390	253.5	360	223.5	2.59
ESAL0610	660	253.5	630	223.5	3.45
ESAL0810	875	253.5	845	223.5	4.13
ESAG0310	390	203.5	360	173.5	2.41
ESAG0610	660	203.5	630	173.5	3.27
ESAG0810	875	203.5	845	173.5	3.95

Quick product references

Overall dimensions

TwinLine S 43 Side view assembly with mounting plate

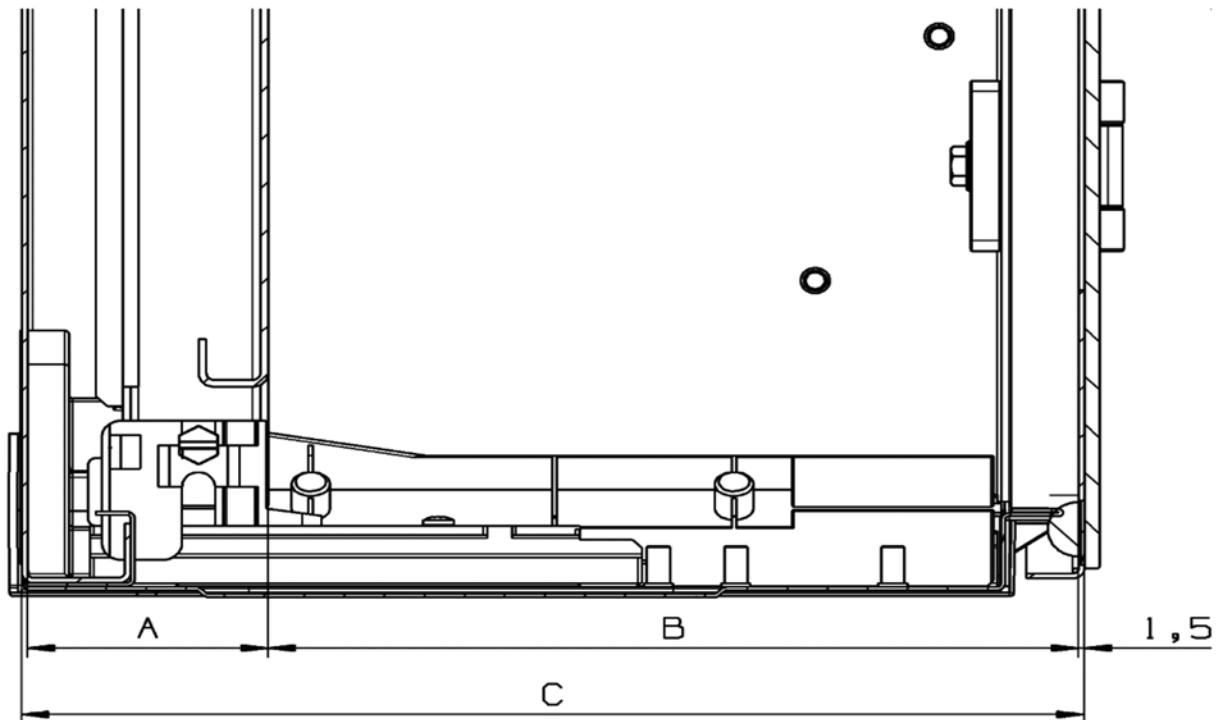

Cabinet series	Depth (C) in mm	A in mm for installation position					
		Pos 3	Pos 2	Pos 1	Pos 0	Pos -1	Pos -2
TwinLine G	225	63	75.5	88	100.5	113	125.5
TwinLine L	275	63	75.5	88	100.5	113	125.5
Cabinet series	Depth (C) in mm	B in mm for installation position					
TwinLine G	225	159	146.5	134	121.5	109	96.5
TwinLine L	275	209	196.5	184	171.5	159	146.5

Quick product references

Overall dimensions

TwinLine S 43 Side view with FlexiLine for 225 mm und 275 mm depth

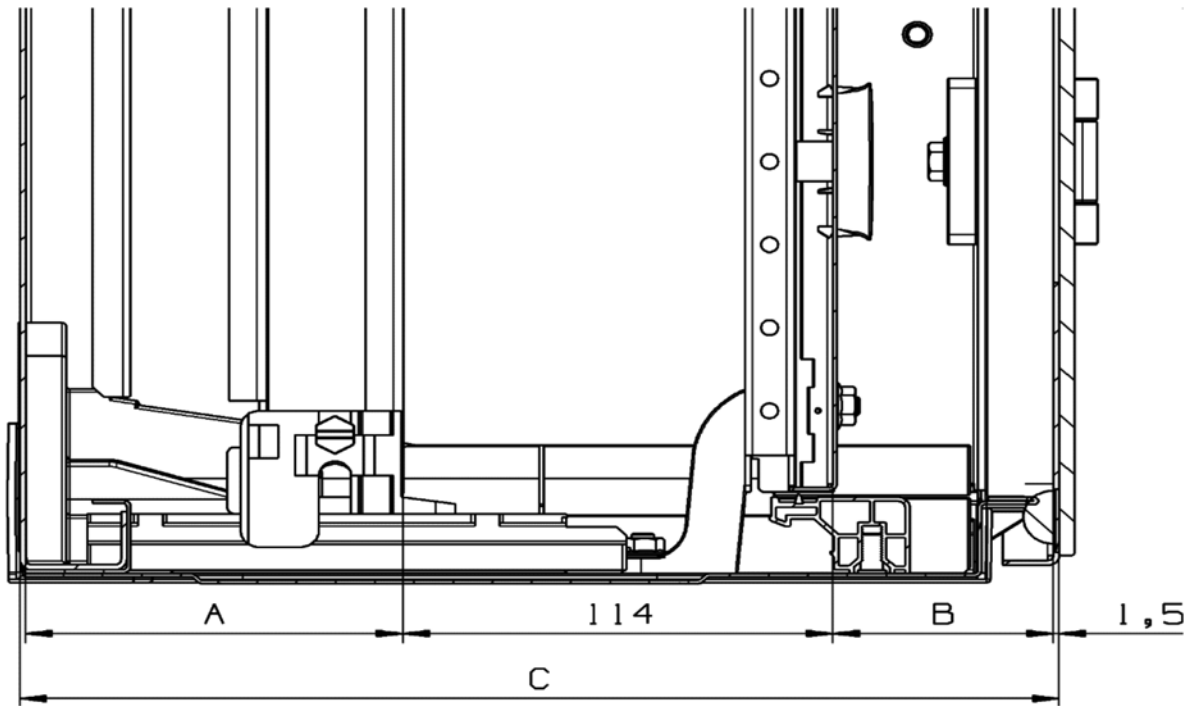

	Depth (C) in mm	A in mm	B in mm
TwinLine G	225	62	46
TwinLine L	275	100	58

Quick product references

Overall dimensions

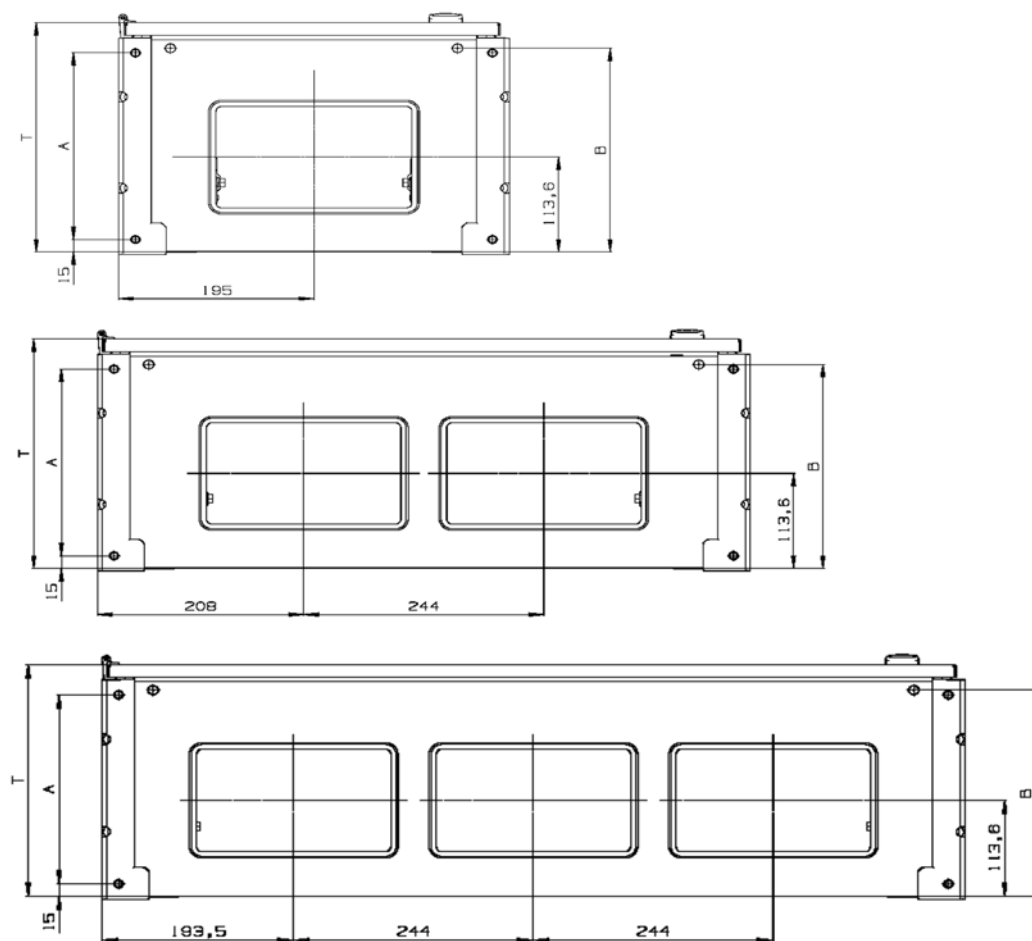

Depth in mm	A in mm	B in mm
225	173,5	170
275	223,5	244

Quick product references

Overall dimensions

Modular consumer units AI10N / AI11N

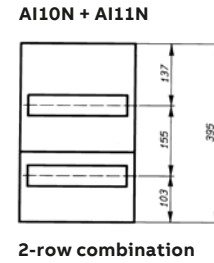
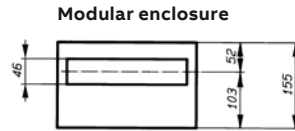
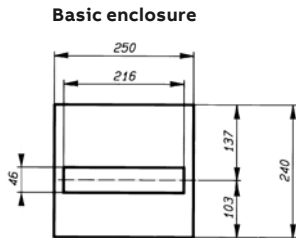

Quick product references

Overall dimensions

Hood-type consumer units A300

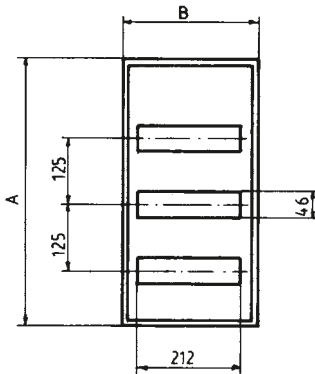

Allowed power loss hood-type consumer units A300

DIN 43871 with over temperature ΔT^*

Type	Power loss (W)		
	ΔT 20 K	ΔT 25 K	ΔT 30 K
A31...	12.5	16.5	21.0
A32...	15.0	20.0	25.0
A33...	17.0	22.0	28.0
A34...	20.5	27.0	34.0

*T is the temperature difference between upper temperature rise limit, mounted devices and ambient.



Type	A	B	C
A31...	245	295	110
A32...	385	295	110
A33...	510	295	110
A34...	635	295	110

Quick product references

Overall dimensions

Compact distribution boards

Type	H	W	H1	W1
AT22E, AL22	374	574	235	417
AT31, AL31	524	324	385	167
AT32, AT32TE, AT32R2, AT32TR2, AL32	524	574	385	417
AT41, AT41TE, AT41R3, AT41TR3, AL41	674	324	535	167
AT42, AT42TE, AT42M, AT42/2, AT42R3, AT42TR3, AL42	674	574	535	417
AT43, AT43R3, AT43TR3, AL43	674	824	535	667
AT51, AT51TE, AT51R4, AT51TR4, AL51	824	324	685	167
AT52, AT52TE, AT52K, AT52/2, AT52R4, AT52TR4, AL52	824	574	685	417
AT53, AT53M, AT53K, AT53R4, AT53TR4, AL53	824	824	685	667
AT54K, AK54E, AT54R4, AL54	824	1074	685	917
AT61, AT61TE, AT61R5, AT61TR5, AL61	974	324	835	167
AT62, AT62TE, AT62K, AT62R5, AT62TR5, AL62	974	574	835	417
AT63E, AT63K, AT63R5, AT63TR5, AL63	974	824	835	667
AT64K, AL64	974	1074	835	917
AT72, AT72K, AT72R6, AT72TR6, AL72	1124	574	985	417
AT73K, AT73R6, AT73TR6, AL73	1124	824	985	667

Dimensions in mm

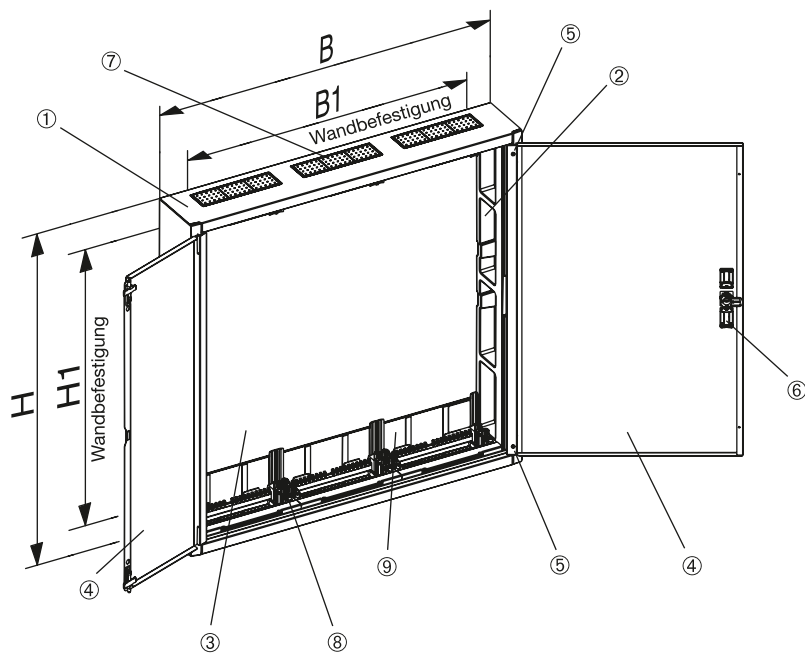

Quick product references

Overall dimensions

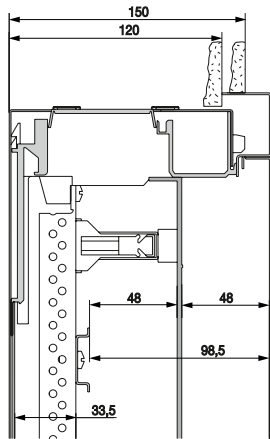

Distribution board panel

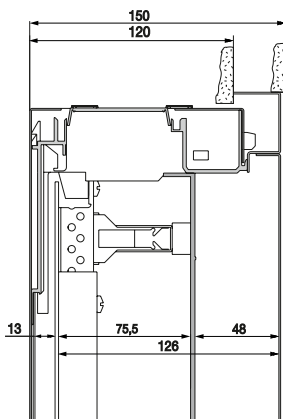

Mounting plate

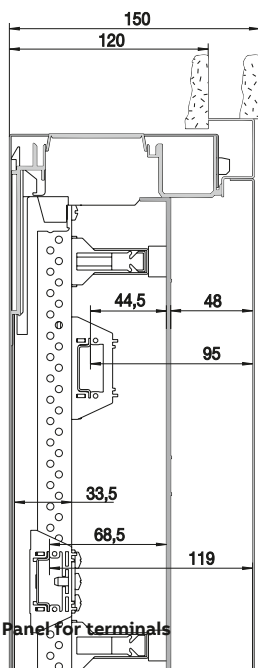

Panel for terminals

Flush-mounting with door. U

Type	Weight in kg	Power loss in Watts $\Delta t_{1,0} 20K$
U32	13.50	33.10
U32R2	13.00	33.10
U32TE	12.50	33.10
U32TR2	11.00	33.10
U41	10.50	24.30
U41R3	10.50	24.30
U41TE	9.00	24.30
U41TR3	9.50	24.30
U42	15.50	40.10
U42/2	16.50	40.10
U42D	16.50	40.10
U42FPT	17.00	40.10
U42M	18.50	40.10
U42R3	16.00	40.10
U42TE	14.00	40.10
U42TR3	14.00	40.10
U43	22.50	57.40
U43R3	23.00	57.40
U43TR3	19.50	57.40
U51	12.50	28.40
U51R4	12.00	28.40
U51TE	12.00	28.40
U51TR4	10.50	28.40
U52	18.50	46.30
U52/2	19.00	46.30
U52K	18.50	46.30
U52R4	18.00	46.30
U52TE	16.00	46.30
U52TR4	16.00	46.30
U53	26.50	65.60
U53K	26.00	65.60
U53M	29.00	65.60
U53R4	26.50	65.60
U53TR4	22.00	65.60
U54E	33.00	61.80
U54K	32.50	61.80
U54R4	33.50	61.80
U61	14.50	32.90
U61R5	14.50	32.90
U61TE	12.50	32.90
U61TR5	12.50	32.90
U62	22.00	53.10
U62K	22.00	53.10
U62R5	22.00	53.10
U62TE	19.00	53.10
U62TR5	19.00	53.10
U63E	31.00	53.30
U63K	30.50	53.30
U63R5	31.50	53.30
U63TR5	26.00	53.30
U64K	38.00	68.30
U72	25.00	59.80
U72K	25.00	59.80
U72R6	26.00	59.80
U72TR6	21.50	59.80
U73K	35.00	62.30
U73R6	35.50	62.30
U73TR6	28.50	62.30

> Dimensions in mm

Quick product references

Overall dimensions

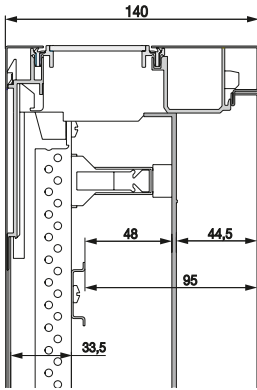

Distribution board panel

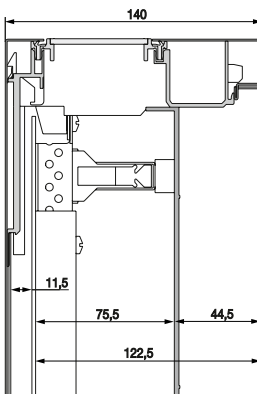

Mounting plate

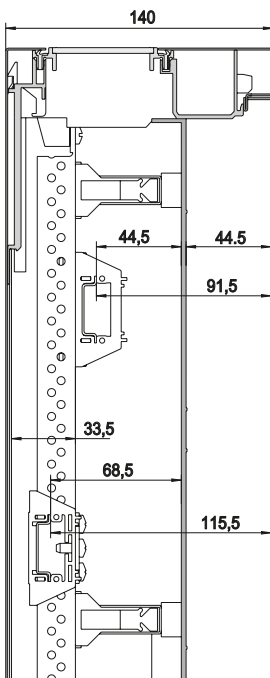

Panel for terminals

Wall-mounting with door. AT		
Type	Weight in kg	Power loss in Watts $\Delta t_{1,0} 20K$
AT22E	9.70	36.30
AT31	7.50	27.30
AT32	12.50	45.30
AT32R2	12.00	45.30
AT32TE	12.00	45.30
AT32TR2	11.50	45.30
AT41	9.50	33.30
AT41R3	10.00	33.30
AT41TE	9.00	33.30
AT41TR3	9.00	33.30
AT42	15.00	53.90
AT42/2	15.50	53.90
AT42M	17.50	53.90
AT42R3	15.00	53.90
AT42TE	13.00	53.90
AT42TR3	13.50	53.90
AT43	21.50	76.30
AT43R3	21.50	76.30
AT43TR3	18.00	76.30
AT51	11.50	39.20
AT51R4	11.50	39.20
AT51TE	11.50	39.20
AT51TR4	11.00	39.20
AT52	17.00	62.60
AT52/2	18.00	62.60
AT52K	17.50	62.60
AT52R4	18.00	62.60
AT52TE	18.00	62.60
AT52TR4	16.00	62.60
AT53	25.00	59.50
AT53K	25.00	59.50
AT53M	28.00	59.50
AT53R4	25.50	59.50
AT53TR4	21.50	59.50
AT54E	32.00	85.10
AT54K	31.00	85.10
AT54R4	32.50	85.10
AT54TR4	26.50	85.10
AT61	13.50	45.40
AT61R5	13.50	45.40
AT61TE	11.50	45.40
AT61TR5	12.00	45.40
AT62	21.00	49.60
AT62K	20.50	49.60
AT62R5	20.00	49.60
AT62TE	20.00	49.60
AT62TR5	20.00	49.60
AT63E	29.50	70.00
AT63K	29.00	70.00
AT63R5	29.00	70.00
AT63TR5	24.00	70.00
AT64K	36.00	100.10
AT72	23.50	57.30
AT72K	23.50	57.30
AT72R6	23.50	57.30
AT72TR6	20.00	57.30
AT73K	33.50	83.60
AT73R6	34.00	83.60
AT73TR6	30.50	83.60

> Dimensions in mm

Quick product references

Overall dimensions

A wall-mounting cabinets IP43

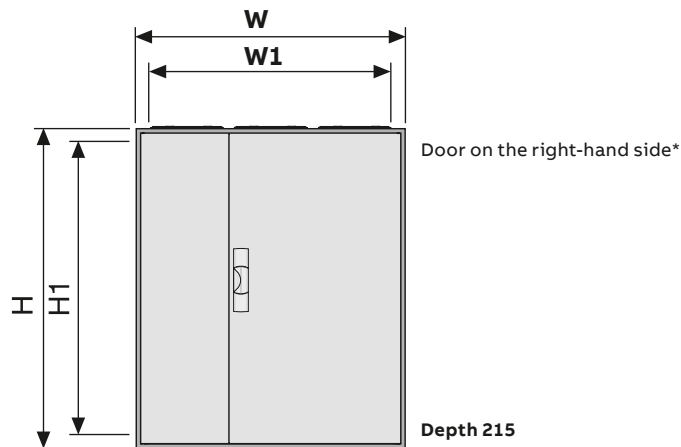

Type	OH	PW	SU	GU	Ext. dimensions		Int. dimensions		Door on the left-hand side*	Door on the right-hand side*	Weight in kg	Power loss in watts $\Delta t_{1,0}$ 20K
					H	W	H1	W1	H x W	H x W		
1/00A	00	1	36	3	500	300	452	252		471.4 x 272	6.20	28.80
2/00A		2	72		500	550	452	502		471.4 x 522	8.40	47.40
3/00A		3	108		500	800	452	752	471.4 x 260	471.4 x 510	12.20	67.10
4/00A		4	144		500	1050	452	1002	471.4 x 510	471.4 x 510	15.80	66.20
5/00A		5	180		500	1300	452	1252	471.4 x 510	471.4 x 760	19.60	83.60
1/0A	0	1	48	4	650	300	602	252		621.4 x 272	7.80	35.20
2/0A		2	96		650	550	602	502		621.4 x 522	11.40	56.20
3/0A		3	144		650	800	602	752	621.4 x 260	621.4 x 510	15.60	59.80
4/0A		4	192		650	1050	602	1002	621.4 x 510	621.4 x 510	16.80	80.90
5/0A		5	240		650	1300	602	1252	621.4 x 510	621.4 x 760	24.00	105.60
1/1A	1	1	60	5	800	300	752	252		771.4 x 272	9.80	41.60
2/1A		2	120		800	550	752	502		771.4 x 522	13.40	65.30
3/1A		3	180		800	800	752	752	771.4 x 260	771.4 x 510	18.00	69.70
4/1A		4	240		800	1050	752	1002	771.4 x 510	771.4 x 510	23.80	96.80
5/1A		5	300		800	1300	752	1252	771.4 x 510	771.4 x 760	28.00	128.40
1/2A	2	1	72	6	950	300	902	252		921.4 x 272	10.80	48.10
2/2A		2	144		950	550	902	502		921.4 x 522	15.60	51.90
3/2A		3	216		950	800	902	752	921.4 x 260	921.4 x 510	21.00	79.20
4/2A		4	288		950	1050	902	1002	921.4 x 510	921.4 x 510	26.80	112.60
5/2A		5	360		950	1300	902	1252	921.4 x 510	921.4 x 760	31.20	150.90
1/3A	3	1	84	7	1100	300	1052	252		1071.4 x 272	12.00	54.50
2/3A		2	168		1100	550	1052	502		1071.4 x 522	17.60	60.70
3/3A		3	252		1100	800	1052	752	1071.4 x 260	1071.4 x 510	23.60	87.50
4/3A		4	336		1100	1050	1052	1002	1071.4 x 510	1071.4 x 510	30.00	131.30
5/3A		5	420		1100	1300	1052	1252	1071.4 x 510	1071.4 x 760	35.20	171.20
1/4A	4	1	96	8	1250	300	1202	252		1221.4 x 272	14.00	60.80
2/4A		2	192		1250	550	1202	502		1221.4 x 522	19.20	68.30
3/4A		3	288		1250	800	1202	752	1221.4 x 260	1221.4 x 510	26.00	101.50
4/4A		4	384		1250	1050	1202	1002	1221.4 x 510	1221.4 x 510	32.40	147.40
5/4A		5	480		1250	1300	1202	1252	1221.4 x 510	1221.4 x 760	40.20	190.50
1/5A	5	1	108	9	1400	300	1352	252		1371.4 x 272	15.00	67.20
2/5A		2	216		1400	550	1352	502		1371.4 x 522	22.40	77.80
3/5A		3	324		1400	800	1352	752	1371.4 x 260	1371.4 x 510	29.20	118.10
4/5A		4	432		1400	1050	1352	1002	1371.4 x 510	1371.4 x 510	35.20	156.00
5/5A		5	540		1400	1300	1352	1252	1371.4 x 510	1371.4 x 760	44.00	205.60

> Dimensions in mm

* Double-wing doors on cabinets with three or more panel widths

Quick product references

Overall dimensions

A wall-mounting cabinets IP43

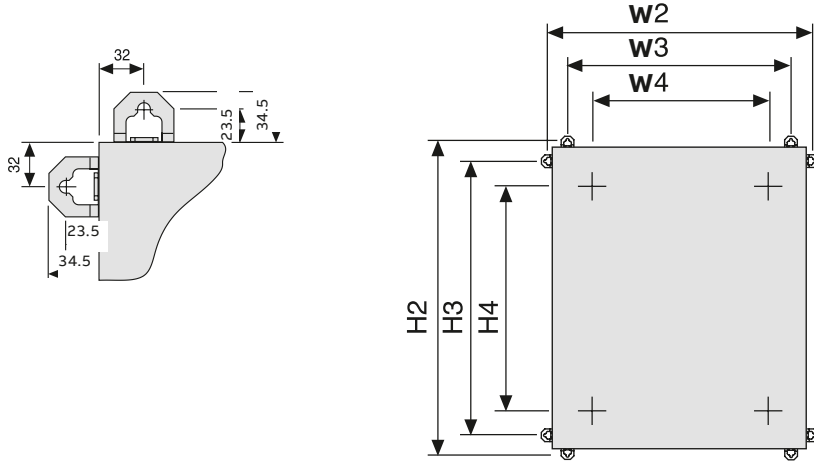

Type	OH	PW	SU	GU	Ext. fastening				Int. fastening		Weight in kg	Power loss in watts $\Delta t_{1,0} 20K$
					H2	H3	W2	W3	H4	W4		
1/00A	00	1	36	3	547	436	347	236	402	170	6.20	28.80
2/00A		2	72		547	436	597	486	402	420	8.40	47.40
3/00A		3	108		547	436	847	736	402	670	12.20	67.10
4/00A		4	144		547	436	1097	986	402	920	15.80	66.20
5/00A		5	180		547	436	1347	1236	402	1170	19.60	83.60
1/0A	0	1	48	4	697	586	347	236	552	170	7.80	35.20
2/0A		2	96		697	586	597	486	552	420	11.40	56.20
3/0A		3	144		697	586	847	736	552	670	15.60	59.80
4/0A		4	192		697	586	1097	986	552	920	16.80	80.90
5/0A		5	240		697	586	1347	1236	552	1170	24.00	105.60
1/1A	1	1	60	5	847	736	347	236	702	170	9.80	41.60
2/1A		2	120		847	736	597	486	702	420	13.40	65.30
3/1A		3	180		847	736	847	736	702	670	18.00	69.70
4/1A		4	240		847	736	1097	986	702	920	23.80	96.80
5/1A		5	300		847	736	1347	1236	702	1170	28.00	128.40
1/2A	2	1	72	6	997	886	347	236	852	170	10.80	48.10
2/2A		2	144		997	886	597	486	852	420	15.60	51.90
3/2A		3	216		997	886	847	736	852	670	21.00	79.20
4/2A		4	288		997	886	1097	986	852	920	26.80	112.60
5/2A		5	360		997	886	1347	1236	852	1170	31.20	150.90
1/3A	3	1	84	7	1147	1036	347	236	1002	170	12.00	54.50
2/3A		2	168		1147	1036	597	486	1002	420	17.60	60.70
3/3A		3	252		1147	1036	847	736	1002	670	23.60	87.50
4/3A		4	336		1147	1036	1097	986	1002	920	30.00	131.30
5/3A		5	420		1147	1036	1347	1236	1002	1170	35.20	171.20
1/4A	4	1	96	8	1297	1186	347	236	1152	170	14.00	60.80
2/4A		2	192		1297	1186	597	486	1152	420	19.20	68.30
3/4A		3	288		1297	1186	847	736	1152	670	26.00	101.50
4/4A		4	384		1297	1186	1097	986	1152	920	32.40	147.40
5/4A		5	480		1297	1186	1347	1236	1152	1170	40.20	190.50
1/5A	5	1	108	9	1447	1336	347	236	1302	170	15.00	67.20
2/5A		2	216		1447	1336	597	486	1302	420	22.40	77.80
3/5A		3	324		1447	1336	847	736	1302	670	29.20	118.10
4/5A		4	432		1447	1336	1097	986	1302	920	35.20	156.00
5/5A		5	540		1447	1336	1347	1236	1302	1170	44.00	205.60

> Dimensions in mm

Quick product references

Overall dimensions

A wall-mounting cabinets IP43 Interior configuration

Cross section with distribution boards panels and combination sets

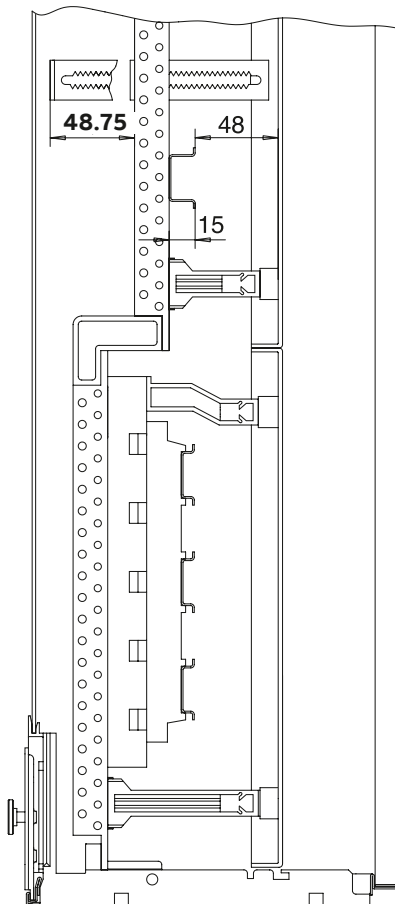
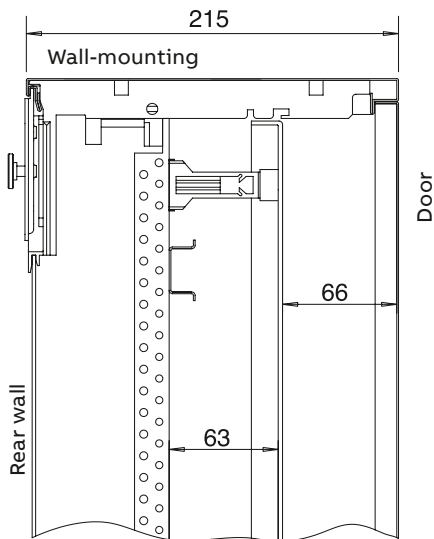

> Dimensions in mm

Quick product references

Overall dimensions

A wall-mounting cabinets IP43 transparent doors

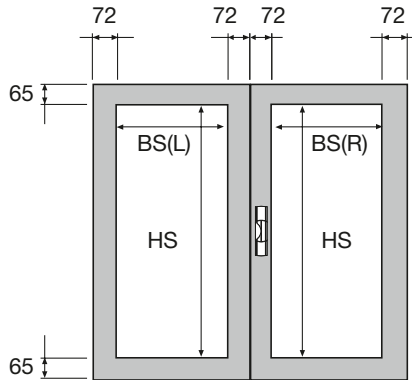

Type	Cabinet				Door on the left	Door on the right	Window on the left	Window on the right
	A Cabinet	OH	PW	GU	H x W	H x W	HW x WW(L)	HW x WW(R)
TTS100	1/00A	00	1	3	-	471.4 x 272	-	341.4 x 128
TTS200	2/00A		2		-	471.4 x 522	-	341.4 x 378
TTS300	3/00A		3		471.4 x 260	471.4 x 510	341.4 x 116	341.4 x 366
TTS400	4/00A		4		471.4 x 510	471.4 x 510	341.4 x 366	341.4 x 366
TTS500	5/00A		5		471.4 x 510	471.4 x 760	341.4 x 366	341.4 x 616
TTS10	1/0A	0	1	4	-	621.4 x 272	-	491.4 x 128
TTS20	2/0A		2		-	621.4 x 522	-	491.4 x 378
TTS30	3/0A		3		621.4 x 260	621.4 x 510	491.4 x 116	491.4 x 366
TTS40	4/0A		4		621.4 x 510	621.4 x 510	491.4 x 366	491.4 x 366
TTS50	5/0A		5		621.4 x 510	621.4 x 760	491.4 x 366	491.4 x 616
TTS11	1/1A	1	1	5	-	771.4 x 272	-	641.4 x 128
TTS21	2/1A		2		-	771.4 x 522	-	641.4 x 378
TTS31	3/1A		3		771.4 x 260	771.4 x 510	641.4 x 116	641.4 x 366
TTS41	4/1A		4		771.4 x 510	771.4 x 510	641.4 x 366	641.4 x 366
TTS51	5/1A		5		771.4 x 510	771.4 x 760	641.4 x 366	641.4 x 616
TTS12	1/2A	2	1	6	-	921.4 x 272	-	791.4 x 128
TTS22	2/2A		2		-	921.4 x 522	-	791.4 x 378
TTS32	3/2A		3		921.4 x 260	921.4 x 510	791.4 x 116	791.4 x 366
TTS42	4/2A		4		921.4 x 510	921.4 x 510	791.4 x 366	791.4 x 366
TTS52	5/2A		5		921.4 x 510	921.4 x 760	791.4 x 366	791.4 x 616
TTS13	1/3A	3	1	7	-	1071.4 x 272	-	941.4 x 128
TTS23	2/3A		2		-	1071.4 x 522	-	941.4 x 378
TTS33	3/3A		3		1071.4 x 260	1071.4 x 510	941.4 x 116	941.4 x 366
TTS43	4/3A		4		1071.4 x 510	1071.4 x 510	941.4 x 366	941.4 x 366
TTS53	5/3A		5		1071.4 x 510	1071.4 x 760	941.4 x 366	941.4 x 616
TTS14	1/4A	4	1	8	-	1221.4 x 272	-	1091.4 x 128
TTS24	2/4A		2		-	1221.4 x 522	-	1091.4 x 378
TTS34	3/4A		3		1221.4 x 260	1221.4 x 510	1091.4 x 116	1091.4 x 366
TTS44	4/4A		4		1221.4 x 510	1221.4 x 510	1091.4 x 366	1091.4 x 366
TTS54	5/4A		5		1221.4 x 510	1221.4 x 760	1091.4 x 366	1091.4 x 616
TTS15	1/5A	5	1	9	-	1371.4 x 272	-	1241.4 x 128
TTS25	2/5A		2		-	1371.4 x 522	-	1241.4 x 378
TTS35	3/5A		3		1371.4 x 260	1371.4 x 510	1241.4 x 116	1241.4 x 366
TTS45	4/5A		4		1371.4 x 510	1371.4 x 510	1241.4 x 366	1241.4 x 366
TTS55	5/5A		5		1371.4 x 510	1371.4 x 760	1241.4 x 366	1241.4 x 616

> Dimensions in mm

*Double-wing doors on cabinets with three or more panel widths

Quick product references

Overall dimensions

B wall-mounting cabinets IP43

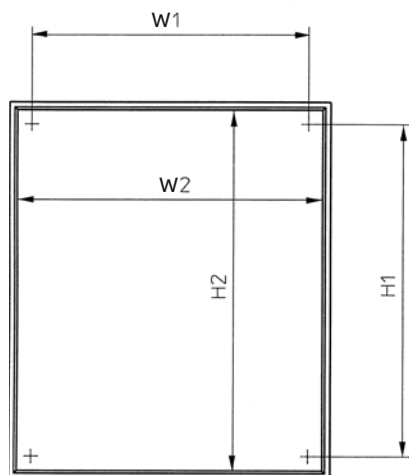

Type	OH	PW	SU	GU	Ext. dimensions			Int. dimensions		Int. fastening dimensions		Weight in kg	Power loss in watts $\Delta t_{1,0} 20K$
					H	W	D	H2	W2	H1	W1		
1/00B	00	1	36	3	500	300	215	452	252	388	188	7,40	28,80
2/00B		2	72		500	550	215	452	502	388	438	9,60	47,40
3/00B		3	108		500	800	215	452	752	388	688	13,40	67,10
1/0B	0	1	48	4	650	300	215	602	252	538	188	9,00	35,20
2/0B		2	96		650	550	215	602	502	538	438	12,60	56,20
3/0B		3	144		650	800	215	602	752	538	688	16,80	59,80
4/0B		4	192		650	1050	215	602	1002	538	938	18,00	80,90
5/0B		5	240		650	1300	215	602	1252	538	1188	25,20	105,60
1/1B	1	1	60	5	800	300	215	752	252	688	188	10,80	41,60
2/1B		2	120		800	550	215	752	502	688	438	14,60	65,30
3/1B		3	180		800	800	215	752	752	688	688	19,20	69,70
4/1B		4	240		800	1050	215	752	1002	688	938	24,80	96,80
5/1B		5	300		800	1300	215	752	1252	688	1188	29,20	128,40
1/2B	2	1	72	6	950	300	215	902	252	838	188	12,00	48,10
2/2B		2	144		950	550	215	902	502	838	438	16,80	51,90
3/2B		3	216		950	800	215	902	752	838	688	22,20	79,20
4/2B		4	288		950	1050	215	902	1002	838	938	28,00	112,60
5/2B		5	360		950	1300	215	902	1252	838	1188	32,40	150,90
1/3B	3	1	84	7	1100	300	215	1052	252	988	188	13,20	54,50
2/3B		2	168		1100	550	215	1052	502	988	438	18,80	60,70
3/3B		3	252		1100	800	215	1052	752	988	688	24,80	87,50
4/3B		4	336		1100	1050	215	1052	1002	988	938	31,20	131,30
5/3B		5	420		1100	1300	215	1052	1252	988	1188	36,40	171,20
1/4B	4	1	96	8	1250	300	215	1202	252	1138	188	15,00	60,80
2/4B		2	192		1250	550	215	1202	502	1138	438	20,40	68,30
3/4B		3	288		1250	800	215	1202	752	1138	688	27,20	101,50
4/4B		4	384		1250	1050	215	1202	1002	1138	938	33,60	147,40
5/4B		5	480		1250	1300	215	1202	1252	1138	1188	41,40	190,50
1/5B	5	1	108	9	1400	300	215	1352	252	1288	188	16,20	67,20
2/5B		2	216		1400	550	215	1352	502	1288	438	23,60	77,80
3/5B		3	324		1400	800	215	1352	752	1288	688	30,40	118,10
4/5B		4	432		1400	1050	215	1352	1002	1288	938	36,40	156,00
5/5B		5	540		1400	1300	215	1352	1252	1288	1188	45,20	205,60

> Dimensions in mm

Quick product references

Overall dimensions

B wall-mounting cabinets IP43

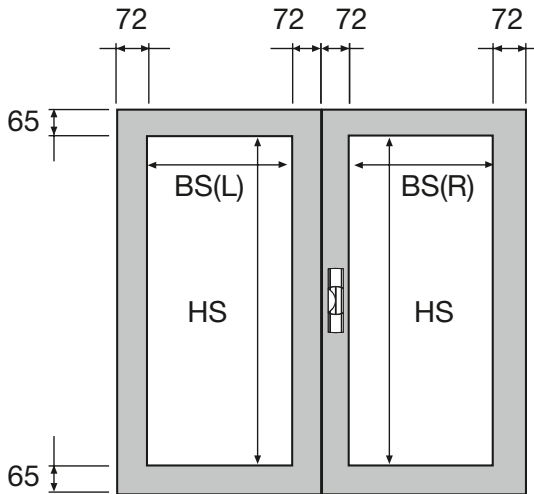

Type	B wall-mounting cabinet	OH	PW	GU	Door on the left-hand side*		Window on the left-hand side	Window on the right-hand side
					H x W	H x W	HW x WW(L)	HW x WW(R)
TTS100	1/00B	00	1	3	-	471.4 x 272	-	341.4 x 128
TTS200	2/00B		2		-	471.4 x 522	-	341.4 x 378
TTS300	3/00B		3		471.4 x 260	471.4 x 510	341.4 x 116	341.4 x 366
TTS400	-		4		471.4 x 510	471.4 x 510	341.4 x 366	341.4 x 366
TTS500	-		5		471.4 x 510	471.4 x 760	341.4 x 366	341.4 x 616
TTS10	1/0B	0	1	4	-	621.4 x 272	-	491.4 x 128
TTS20	2/0B		2		-	621.4 x 522	-	491.4 x 378
TTS30	3/0B		3		621.4 x 260	621.4 x 510	491.4 x 116	491.4 x 366
TTS40	4/0B		4		621.4 x 510	621.4 x 510	491.4 x 366	491.4 x 366
TTS50	5/0B		5		621.4 x 510	621.4 x 760	491.4 x 366	491.4 x 616
TTS11	1/1B	1	1	5	-	771.4 x 272	-	641.4 x 128
TTS21	2/1B		2		-	771.4 x 522	-	641.4 x 378
TTS31	3/1B		3		771.4 x 260	771.4 x 510	641.4 x 116	641.4 x 366
TTS41	4/1B		4		771.4 x 510	771.4 x 510	641.4 x 366	641.4 x 366
TTS51	5/1B		5		771.4 x 510	771.4 x 760	641.4 x 366	641.4 x 616
TTS12	1/2B	2	1	6	-	921.4 x 272	-	791.4 x 128
TTS22	2/2B		2		-	921.4 x 522	-	791.4 x 378
TTS32	3/2B		3		921.4 x 260	921.4 x 510	791.4 x 116	791.4 x 366
TTS42	4/2B		4		921.4 x 510	921.4 x 510	791.4 x 366	791.4 x 366
TTS52	5/2B		5		921.4 x 510	921.4 x 760	791.4 x 366	791.4 x 616
TTS13	1/3B	3	1	7	-	1071.4 x 272	-	941.4 x 128
TTS23	2/3B		2		-	1071.4 x 522	-	941.4 x 378
TTS33	3/3B		3		1071.4 x 260	1071.4 x 510	941.4 x 116	941.4 x 366
TTS43	4/3B		4		1071.4 x 510	1071.4 x 510	941.4 x 366	941.4 x 366
TTS53	5/3B		5		1071.4 x 510	1071.4 x 760	941.4 x 366	941.4 x 616
TTS14	1/4B	4	1	8	-	1221.4 x 272	-	1091.4 x 128
TTS24	2/4B		2		-	1221.4 x 522	-	1091.4 x 378
TTS34	3/4B		3		1221.4 x 260	1221.4 x 510	1091.4 x 116	1091.4 x 366
TTS44	4/4B		4		1221.4 x 510	1221.4 x 510	1091.4 x 366	1091.4 x 366
TTS54	5/4B		5		1221.4 x 510	1221.4 x 760	1091.4 x 366	1091.4 x 616
TTS15	1/5B	5	1	9	-	1371.4 x 272	-	1241.4 x 128
TTS25	2/5B		2		-	1371.4 x 522	-	1241.4 x 378
TTS35	3/5B		3		1371.4 x 260	1371.4 x 510	1241.4 x 116	1241.4 x 366
TTS45	4/5B		4		1371.4 x 510	1371.4 x 510	1241.4 x 366	1241.4 x 366
TTS55	5/5B		5		1371.4 x 510	1371.4 x 760	1241.4 x 366	1241.4 x 616

> Dimensions in mm

*Double-wing doors on cabinets with three or more panel widths

Quick product references

Overall dimensions

H and HS floor-standing cabinets IP43

HS floor-standing cabinets

With mounted EDF installation set for installing distribution board panels, combination sets and modules on the EDF mounting frame, using the ZB15 assembly set, it is also possible to incorporate meter panels.

H floor-standing cabinets

With mounted EDF installation set for installing distribution board panels, combination sets and modules on the EDF mounting frame.

Type	Weight (kg) with plinth	Power loss (W) $\Delta t_{1,0}$ 20K	Ext. dimensions with plinth H x W x D	Int. dimensions H1 x W1
1/8HS	30.33	67,40	1900 x 300 x 225	1802 x 252
2/8HS	44.62	119,20	1900 x 550 x 225	1802 x 502
3/8HS	57.20	170,90	1900 x 800 x 225	1802 x 752
4/8HS	73.41	206,80	1900 x 1050 x 225	1802 x 1002
1/8H	29.63	67,40	1900 x 300 x 225	1802 x 252
2/8H	43.88	119,20	1900 x 550 x 225	1802 x 502
3/8H	56.06	170,90	1900 x 800 x 225	1802 x 752
4/8H	70.83	206,80	1900 x 1050 x 225	1802 x 1002

> Dimensions in mm

Cross section, HS cabinet
with meter panel

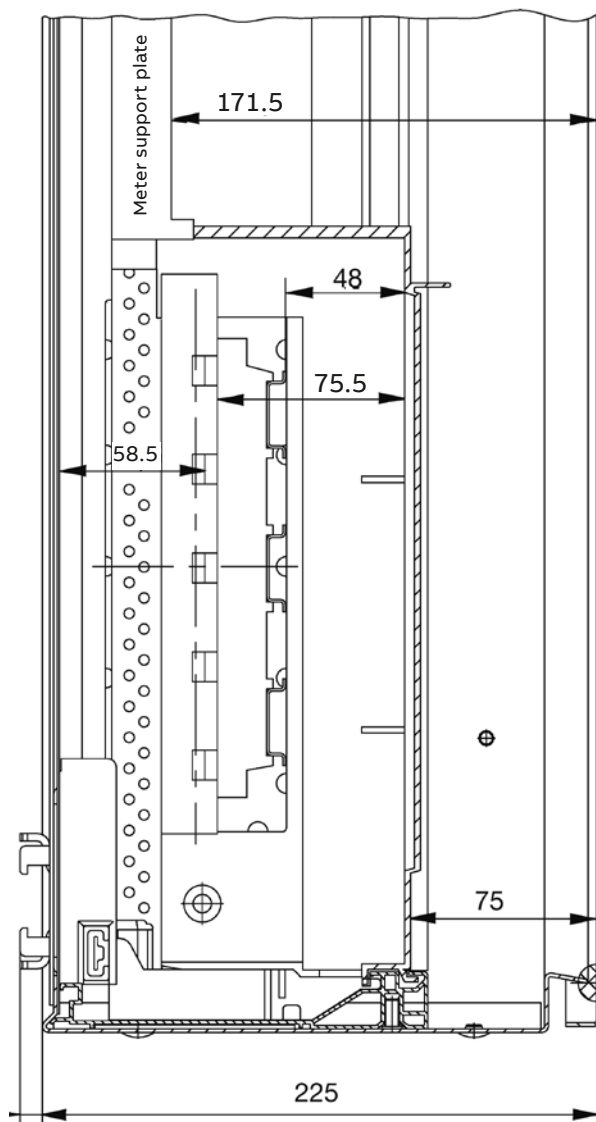

Cross section H-cabinet
with distribution board panels/modules
on the EDF mounting frame

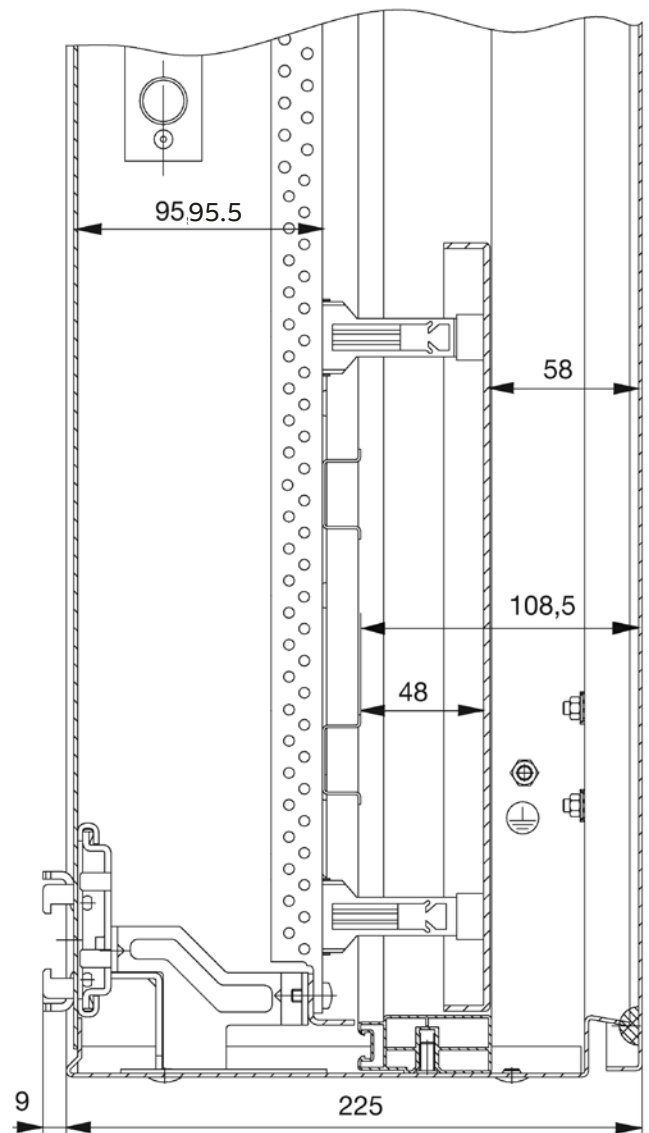

Quick product references

Overall dimensions

H and HS floor-standing cabinets IP43 Plinth dimensions

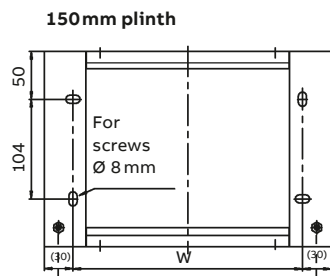
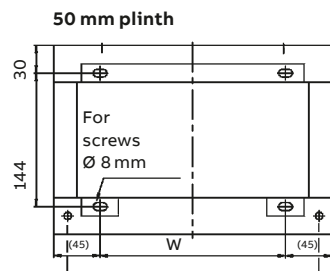

	Type	Fixing the plinth on the cabinet A in mm	Fixing the plinth on the floor B in mm
Hole spacing for fixing the plinth on the floor Plinth, height 50mm	GSR1	270 mm	210 mm
	GSR2	520 mm	460 mm
	GSR3	770 mm	710 mm
	GSR4	1020 mm	960 mm
Hole spacing for fixing the plinth on the floor Plinth, height 150mm	GRG1	270 mm	240 mm
	GRG2	520 mm	490 mm
	GRG3	770 mm	740 mm
	GRG4	1020 mm	990 mm

TwinLine-G, cabinet depth 225 mm,

**Front view
Wall-mounting and
floor-standing cabinet
External/internal dimensions**

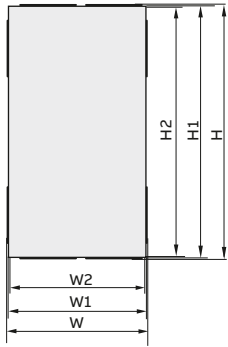

**Front view
Wall-mounting cabinet
Wall fastening dimensions**

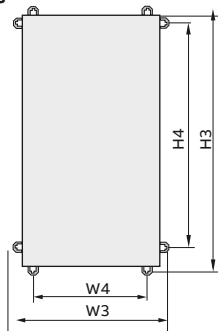

**Front view
Floor-standing cabinet
Wall fastening dimensions**

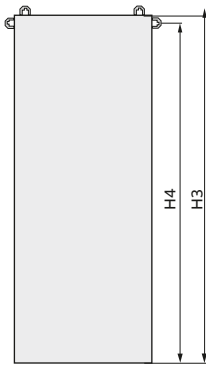

**Front view
External fastening
Detail**

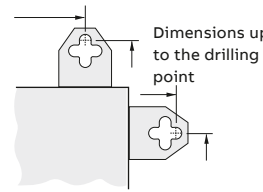

**Side view
With/without
door**

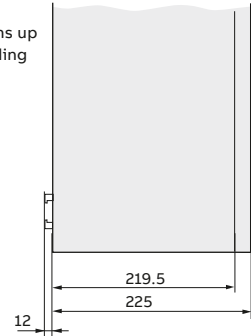

Height			Width	Type	External dimensions in mm		Internal dimensions in mm		External dimensions with flange knockout in mm		Wall fastening dimensions in mm			
GU	OH	PW			H1	W1	H2	W2	H	W	H3	W3	H4	W4
TwinLine-G wall-mounting cabinets $\frac{1}{2}$ \square														
4	0	1	TG104	650	300	602	252	654	304	693.5	328	542	192	
		2	TG204	650	550	602	502	654	554	693.5	578	542	442	
		3	TG304	650	800	602	752	654	804	693.5	828	542	692	
		4	TG404	650	1050	602	1002	654	1054	693.5	1078	542	942	
		5	TG504	650	1300	602	1252	654	1304	693.5	1328	542	1192	
5	1	1	TG105	800	300	752	252	804	304	843.5	328	692	192	
		2	TG205	800	550	752	502	804	554	843.5	578	692	442	
		3	TG305	800	800	752	752	804	804	843.5	828	692	692	
		4	TG405	800	1050	752	1002	804	1054	843.5	1078	692	942	
		5	TG505	800	1300	752	1252	804	1304	843.5	1328	692	1192	
6	2	1	TG106	950	300	902	252	954	304	993.5	328	842	192	
		2	TG206	950	550	902	502	954	554	993.5	578	842	442	
		3	TG306	950	800	902	752	954	804	993.5	828	842	692	
		4	TG406	950	1050	902	1002	954	1054	993.5	1078	842	942	
		5	TG506	950	1300	902	1252	954	1304	993.5	1328	842	1192	
7	3	1	TG107	1100	300	1052	252	1104	304	1143.5	328	992	192	
		2	TG207	1100	550	1052	502	1104	554	1143.5	578	992	442	
		3	TG307	1100	800	1052	752	1104	804	1143.5	828	992	692	
		4	TG407	1100	1050	1052	1002	1104	1054	1143.5	1078	992	942	
		5	TG507	1100	1300	1052	1252	1104	1304	1143.5	1328	992	1192	
8	4	1	TG108	1250	300	1202	252	1254	304	1293.5	328	1142	192	
		2	TG208	1250	550	1202	502	1254	554	1293.5	578	1142	442	
		3	TG308	1250	800	1202	752	1254	804	1293.5	828	1142	692	
		4	TG408	1250	1050	1202	1002	1254	1054	1293.5	1078	1142	942	
		5	TG508	1250	1300	1202	1252	1254	1304	1293.5	1328	1142	1192	
9	5	1	TG109	1400	300	1352	252	1404	304	1443.5	328	1292	192	
		2	TG209	1400	550	1352	502	1404	554	1443.5	578	1292	442	
		3	TG309	1400	800	1352	752	1404	804	1443.5	828	1292	692	
		4	TG409	1400	1050	1352	1002	1404	1054	1443.5	1078	1292	942	
		5	TG509	1400	1300	1352	1252	1404	1304	1443.5	1328	1292	1192	
TwinLine-G floor-standing cabinets $\frac{1}{2}$ \square														
12	8	1	TG112	1850	300	1802	252	1854	304	1872	328	1796	192	
		2	TG212	1850	550	1802	502	1854	554	1872	578	1796	442	
		3	TG312	1850	800	1802	752	1854	804	1872	828	1796	692	
		4	TG412	1850	1050	1802	1002	1854	1054	1872	1078	1796	942	
		5	TG512	1850	1300	1802	1252	1854	1304	1872	1328	1796	1192	

> Dimensions in mm

Quick product references

Overall dimensions

TwinLine-G, cabinet depth 225 mm, ..

Type of installation
Cabinet to the wall

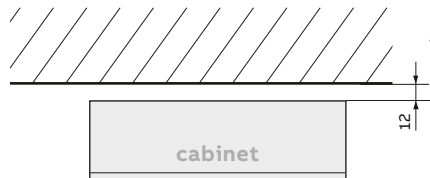

Type of installation
Cabinet combination
in series

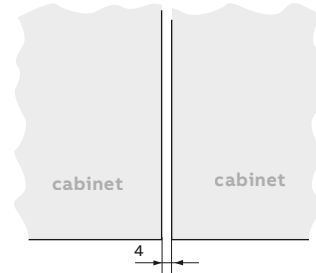

Type of installation
Cabinet combination
on top of each other

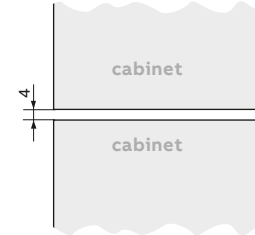

Height		Width		±/▣ Power loss in Watt* Δt _{1,0} 20K	± Cabinet weight in kg		▣ Cabinet weight in kg		max. installation weight in kg
GU	OH	PW	Type		With door	Without door	With door	Without door	
TwinLine-G wall-mounting cabinets ±/▣									
4	0	1	TG104	35.80	11.40	7.43	12.89	8.92	15.00
		2	TG204	57.00	16.17	9.95	17.80	11.59	30.00
		3	TG304	61.00	21.02	12.47	22.80	14.25	45.00
		4	TG404	82.30	28.03	15.54	29.95	17.46	60.00
		5	TG504	107.80	32.86	18.07	34.92	20.13	75.00
5	1	1	TG105	42.30	13.17	8.40	14.86	10.10	20.50
		2	TG205	66.10	18.72	11.22	20.60	13.11	41.00
		3	TG305	71.00	24.29	14.03	26.37	16.11	61.50
		4	TG405	99.00	32.45	17.40	34.71	19.67	82.50
		5	TG505	131.20	38.03	20.22	40.49	22.68	103.00
6	2	1	TG106	48.80	14.89	9.37	16.78	11.26	26.00
		2	TG206	52.60	21.23	12.43	23.36	14.61	52.50
		3	TG306	80.90	27.55	15.59	29.92	17.37	78.50
		4	TG406	115.10	36.84	19.25	39.46	21.86	105.00
		5	TG506	153.70	43.18	22.36	46.03	25.09	131.00
7	3	1	TG107	55.40	17.14	10.72	19.23	12.81	31.50
		2	TG207	61.40	24.36	14.25	26.74	16.64	63.50
		3	TG307	93.50	31.56	17.79	34.23	20.46	95.50
		4	TG407	133.70	42.23	21.87	45.19	24.83	127.50
		5	TG507	174.30	49.44	25.41	52.69	28.66	159.00
8	4	1	TG108	61.80	18.90	11.68	21.20	13.98	37.50
		2	TG208	69.30	26.87	15.51	29.50	18.15	75.00
		3	TG308	102.90	34.82	19.34	37.80	22.31	112.50
		4	TG408	150.30	46.64	23.72	50.01	27.10	150.00
		5	TG508	193.30	54.59	27.55	58.31	31.27	187.50
9	5	1	TG109	68.20	20.66	12.65	23.15	15.14	43.00
		2	TG209	79.10	29.38	16.77	32.23	19.65	86.00
		3	TG309	119.30	38.08	20.89	41.35	24.16	129.00
		4	TG409	157.50	51.04	25.57	54.77	29.31	172.50
		5	TG509	208.80	59.74	29.69	63.87	33.82	215.50
TwinLine-G floor-standing cabinets ±/▣									
12	8	1	TG112	64.00	26.17	15.78	28.89	18.50	60.00
		2	TG212	113.00	40.22	23.81	43.73	27.31	120.00
		3	TG312	162.60	51.87	29.54	56.17	33.84	180.00
		4	TG412	202.10	69.40	36.27	74.59	41.46	240.00
		5	TG512	230.80	80.19	41.11	86.17	47.09	300.00

* General remarks on the determination of the power loss: Values according to DIN EN 61439-1 section 10.10.4.2.2; ambient temperature 35°C, internal temperature 55°C, the allowed device temperature must not be exceeded, levelling of the place of installation ≤ 2000 m altitude; internal form of separation = 1; side walls not covered

TwinLine-L, cabinet depth 275 mm,

Front view
Wall-mounting and floor-standing cabinet
External/internal dimensions

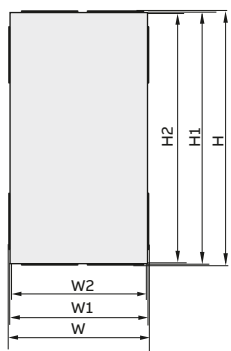

Front view
Wall-mounting cabinet
Wall fastening dimensions

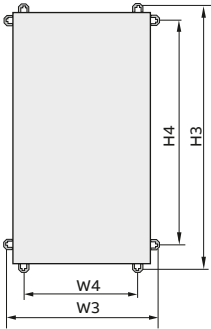

Front view
Floor-standing cabinet
Wall fastening dimensions

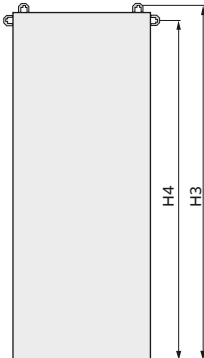

Front view
External fastening
Detail

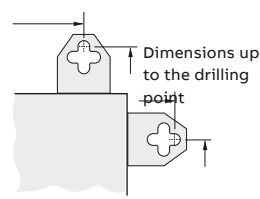

Side view
With/without door

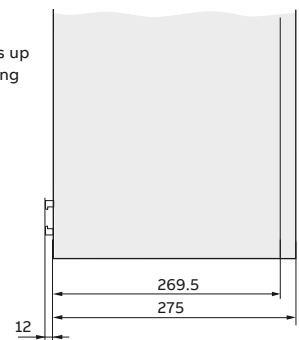

Height		Width		External dimensions in mm		Internal dimensions in mm		External dimensions with flange knockout in mm		Wall fastening dimensions in mm			
GU	OH	PW	Type	H1	W1	H2	W2	H	W	H3	W3	H4	W4
TwinLine-L wall-mounting cabinets $\frac{1}{2}$ \square													
4	0	1	TL104	650	300	602	252	654	304	693.5	328	542	192
		2	TL204	650	550	602	502	654	554	693.5	578	542	442
		3	TL304	650	800	602	752	654	804	693.5	828	542	692
		4	TL404	650	1050	602	1002	654	1054	693.5	1078	542	942
		5	TL504	650	1300	602	1252	654	1304	693.5	1328	542	1192
5	1	1	TL105	800	300	752	252	804	304	843.5	328	692	192
		2	TL205	800	550	752	502	804	554	843.5	578	692	442
		3	TL305	800	800	752	752	804	804	843.5	828	692	692
		4	TL405	800	1050	752	1002	804	1054	843.5	1078	692	942
		5	TL505	800	1300	752	1252	804	1304	843.5	1328	692	1192
6	2	1	TL106	950	300	902	252	954	304	993.5	328	842	192
		2	TL206	950	550	902	502	954	554	993.5	578	842	442
		3	TL306	950	800	902	752	954	804	993.5	828	842	692
		4	TL406	950	1050	902	1002	954	1054	993.5	1078	842	942
		5	TL506	950	1300	902	1252	954	1304	993.5	1328	842	1192
7	3	1	TL107	1100	300	1052	252	1104	304	1143.5	328	992	192
		2	TL207	1100	550	1052	502	1104	554	1143.5	578	992	442
		3	TL307	1100	800	1052	752	1104	804	1143.5	828	992	692
		4	TL407	1100	1050	1052	1002	1104	1054	1143.5	1078	992	942
		5	TL507	1100	1300	1052	1252	1104	1304	1143.5	1328	992	1192
8	4	1	TL108	1250	300	1202	252	1254	304	1293.5	328	1142	192
		2	TL208	1250	550	1202	502	1254	554	1293.5	578	1142	442
		3	TL308	1250	800	1202	752	1254	804	1293.5	828	1142	692
		4	TL408	1250	1050	1202	1002	1254	1054	1293.5	1078	1142	942
		5	TL508	1250	1300	1202	1252	1254	1304	1293.5	1328	1142	1192
9	5	1	TL109	1400	300	1352	252	1404	304	1443.5	328	1292	192
		2	TL209	1400	550	1352	502	1404	554	1443.5	578	1292	442
		3	TL309	1400	800	1352	752	1404	804	1443.5	828	1292	692
		4	TL409	1400	1050	1352	1002	1404	1054	1443.5	1078	1292	942
		5	TL509	1400	1300	1352	1252	1404	1304	1443.5	1328	1292	1192
TwinLine-L floor-standing cabinets $\frac{1}{2}$ \square													
12	8	1	TL112	1850	300	1802	252	1854	304	1872	328	1796	192
		2	TL212	1850	550	1802	502	1854	554	1872	578	1796	442
		3	TL312	1850	800	1802	752	1854	804	1872	828	1796	692
		4	TL412	1850	1050	1802	1002	1854	1054	1872	1078	1796	942
		5	TL512	1850	1300	1802	1252	1854	1304	1872	1328	1796	1192

> Dimensions in mm

Quick product references

Overall dimensions

TwinLine-L, cabinet depth 275 mm .,

Type of installation
Cabinet to the wall

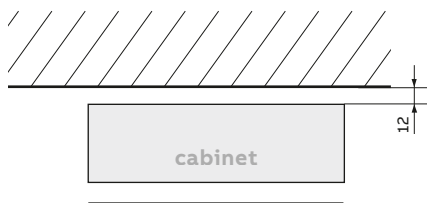

Type of installation
Cabinet combination
in series

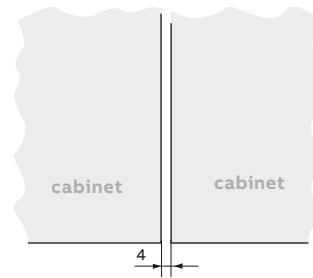

Type of installation
Cabinet combination
on top of each other

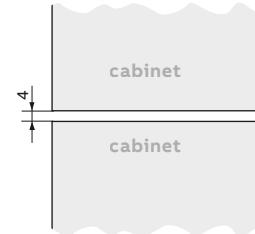

Height		Width		Type	≡/⊠ Power loss in Watt* Δt _{1,0} 20K	≡ Cabinet weight in kg		⊠ Cabinet weight in kg		max. installation weight in kg
GU	OH	PW				With door	Without door	With door	Without door	
TwinLine-L wall-mounting cabinets ≡⊠										
4	0	1	TL104	38.80	12.25	8.28	13.80	9.83	15.00	
		2	TL204	60.80	17.23	10.97	18.94	12.72	30.00	
		3	TL304	67.10	22.30	13.75	24.16	15.61	45.00	
		4	TL404	89.70	29.54	17.06	31.54	19.08	60.00	
		5	TL504	116.80	34.59	19.79	36.76	21.97	75.00	
5	1	1	TL105	45.80	14.13	9.37	15.89	11.13	20.50	
		2	TL205	70.20	19.90	12.40	21.86	14.36	41.00	
		3	TL305	78.00	25.68	15.43	27.86	17.60	61.50	
		4	TL405	108.90	34.08	19.03	36.45	21.38	82.50	
		5	TL505	145.10	39.87	22.06	42.46	24.64	103.00	
6	2	1	TL106	52.80	15.97	10.45	17.94	12.35	26.00	
		2	TL206	59.90	22.53	13.78	24.75	16.00	52.50	
		3	TL306	89.80	29.06	17.10	31.54	19.58	78.50	
		4	TL406	128.10	38.59	21.00	41.32	23.73	105.00	
		5	TL506	168.00	45.14	24.32	48.09	27.28	131.00	
7	3	1	TL107	59.80	18.34	11.89	20.51	14.09	31.50	
		2	TL207	65.20	25.77	15.67	28.25	18.15	63.50	
		3	TL307	102.80	33.19	19.41	35.97	22.20	95.50	
		4	TL407	145.70	44.10	23.74	47.19	27.14	127.50	
		5	TL507	189.20	51.51	27.48	54.91	30.88	159.00	
8	4	1	TL108	66.70	20.22	13.00	22.61	15.39	37.50	
		2	TL208	74.40	28.40	17.04	31.14	19.78	75.00	
		3	TL308	117.80	36.57	21.09	39.66	24.18	112.50	
		4	TL408	163.70	48.62	25.70	52.14	29.22	150.00	
		5	TL508	207.70	56.79	29.75	60.65	33.61	187.50	
9	5	1	TL109	52.20	22.39	14.09	24.69	16.68	43.00	
		2	TL209	86.00	31.03	18.42	34.03	21.42	86.00	
		3	TL309	126.00	39.95	22.76	43.35	26.16	129.00	
		4	TL409	179.10	53.14	27.68	57.02	31.55	172.50	
		5	TL509	222.10	62.05	32.01	66.34	36.29	215.50	
TwinLine-L floor-standing cabinets ≡⊠										
12	8	1	TL112	69.60	27.96	17.57	30.84	20.45	60.00	
		2	TL212	120.90	42.23	25.81	45.91	29.49	120.00	
		3	TL312	171.90	54.09	31.76	58.58	36.24	180.00	
		4	TL412	207.00	71.86	38.72	77.25	44.12	240.00	
		5	TL512	250.30	83.46	44.37	89.66	50.57	300.00	

* General remarks on the determination of the power loss: Values according to DIN EN 61439-1, section 10.10.4.2.2; ambient temperature 35°C, internal temperature 55°C, the allowed device temperature must not be exceeded, levelling of the place of installation ≤ 2000 m altitude; internal form of separation = 1; side walls not covered

TwinLine-W, cabinet depth 350 mm,

**Front view
Wall-mounting and
floor-standing cabinet
External/internal dimensions**

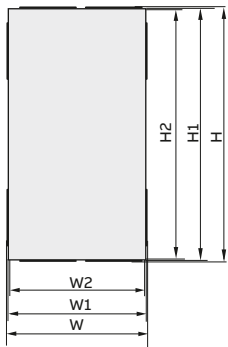

**Front view
Wall-mounting cabinet
Wall fastening dimensions**

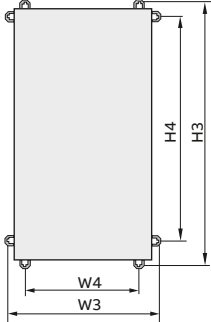

**Front view
Floor-standing cabinet
Wall fastening
dimensions**

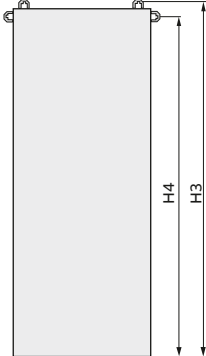

**Front view
External fastening
Detail**

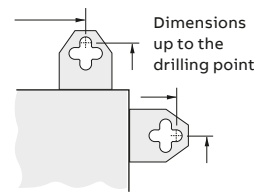

**Side view
With/without door**

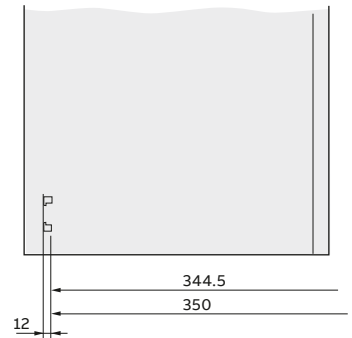

Height		Width		External dimensions in mm		Internal dimensions in mm		External dimensions with flange knockout in mm		Wall fastening dimensions in mm			
GU	OH	PW	Type	H1	W1	H2	W2	H	W	H3	W3	H4	W4
TwinLine-W wall-mounting cabinets $\frac{\perp}{\square}$													
4	0	1	TW104	650	300	602	252	654	304	693.5	328	542	192
		2	TW204	650	550	602	502	654	554	693.5	578	542	442
		3	TW304	650	800	602	752	654	804	693.5	828	542	692
		4	TW404	650	1050	602	1002	654	1054	693.5	1078	542	942
		5	TW504	650	1300	602	1252	654	1304	693.5	1328	542	1192
5	1	1	TW105	800	300	752	252	804	304	843.5	328	692	192
		2	TW205	800	550	752	502	804	554	843.5	578	692	442
		3	TW305	800	800	752	752	804	804	843.5	828	692	692
		4	TW405	800	1050	752	1002	804	1054	843.5	1078	692	942
		5	TW505	800	1300	752	1252	804	1304	843.5	1328	692	1192
6	2	1	TW106	950	300	902	252	954	304	993.5	328	842	192
		2	TW206	950	550	902	502	954	554	993.5	578	842	442
		3	TW306	950	800	902	752	954	804	993.5	828	842	692
		4	TW406	950	1050	902	1002	954	1054	993.5	1078	842	942
		5	TW506	950	1300	902	1252	954	1304	993.5	1328	842	1192
7	3	1	TW107	1100	300	1052	252	1104	304	1143.5	328	992	192
		2	TW207	1100	550	1052	502	1104	554	1143.5	578	992	442
		3	TW307	1100	800	1052	752	1104	804	1143.5	828	992	692
		4	TW407	1100	1050	1052	1002	1104	1054	1143.5	1078	992	942
		5	TW507	1100	1300	1052	1252	1104	1304	1143.5	1328	992	1192
8	4	1	TW108	1250	300	1202	252	1254	304	1293.5	328	1142	192
		2	TW208	1250	550	1202	502	1254	554	1293.5	578	1142	442
		3	TW308	1250	800	1202	752	1254	804	1293.5	828	1142	692
		4	TW408	1250	1050	1202	1002	1254	1054	1293.5	1078	1142	942
		5	TW508	1250	1300	1202	1252	1254	1304	1293.5	1328	1142	1192
9	5	1	TW109	1400	300	1352	252	1404	304	1443.5	328	1292	192
		2	TW209	1400	550	1352	502	1404	554	1443.5	578	1292	442
		3	TW309	1400	800	1352	752	1404	804	1443.5	828	1292	692
		4	TW409	1400	1050	1352	1002	1404	1054	1443.5	1078	1292	942
		5	TW509	1400	1300	1352	1252	1404	1304	1443.5	1328	1292	1192
TwinLine-W floor-standing cabinets $\frac{\perp}{\square}$													
12	8	1	TW112	1850	300	1802	252	1854	304	1872	328	1796	192
		2	TW212	1850	550	1802	502	1854	554	1872	578	1796	442
		3	TW312	1850	800	1802	752	1854	804	1872	828	1796	692
		4	TW412	1850	1050	1802	1002	1854	1054	1872	1078	1796	942
		5	TW512	1850	1300	1802	1252	1854	1304	1872	1328	1796	1192
		6	TW612	1850	1550	1802	1502	1854	1554	1872	1578	1796	1442

Quick product references

Overall dimensions

TwinLine-W, cabinet depth 350 mm

Type of installation
Cabinet to the wall

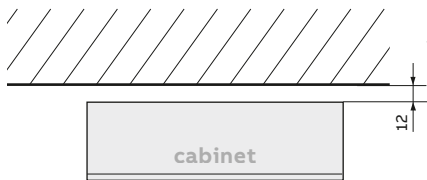

Type of installation
Cabinet combination
in series

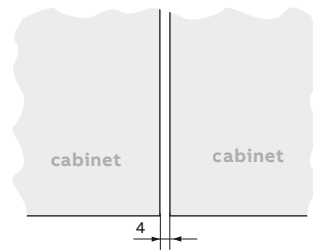

Type of installation
Cabinet combination
on top of each other

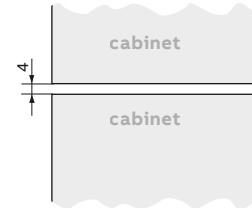

Height		Width		±/▣ Power loss in Watt* Δt _{1,0} 20K	± Cabinet weight in kg		▣ Cabinet weight in kg		max. installation weight in kg
GU	OH	PW	Type		With door	Without door	With door	Without door	
TwinLine-W wall-mounting cabinets ±/▣									
4	0	1	TW104	43.00	13.50	9.47	15.13	11.16	15.00
		2	TW204	65.90	18.79	12.58	20.60	14.38	30.00
		3	TW304	75.90	24.17	15.62	26.16	17.61	45.00
		4	TW404	100.10	31.76	19.27	33.92	21.44	60.00
		5	TW504	129.30	37.12	22.32	39.46	24.66	75.00
5	1	1	TW105	50.50	15.56	10.80	17.41	12.65	20.50
		2	TW205	59.80	21.64	14.14	23.72	16.21	41.00
		3	TW305	87.70	27.74	17.48	30.04	19.78	61.50
		4	TW405	121.30	36.47	21.42	39.00	23.95	82.50
		5	TW505	158.90	42.58	24.77	45.33	27.52	103.00
6	2	1	TW106	58.20	17.58	12.06	19.65	14.13	26.00
		2	TW206	68.20	24.44	15.69	26.79	18.04	52.50
		3	TW306	102.80	31.29	19.33	33.91	21.95	78.50
		4	TW406	144.80	41.16	23.57	44.06	26.46	105.00
		5	TW506	185.80	48.02	27.20	51.19	30.07	131.00
7	3	1	TW107	65.80	20.12	13.70	22.41	15.99	31.50
		2	TW207	75.70	27.87	17.76	30.48	20.38	63.50
		3	TW307	116.50	35.59	21.82	38.53	24.76	95.50
		4	TW407	163.60	46.84	26.48	50.11	29.75	127.50
		5	TW507	209.30	54.58	30.55	58.16	34.13	159.00
8	4	1	TW108	52.00	22.18	14.96	24.81	17.48	37.50
		2	TW208	82.70	30.67	19.32	33.56	22.20	75.00
		3	TW308	132.60	39.15	23.67	42.42	26.93	112.50
		4	TW408	180.80	51.55	28.63	55.25	32.33	150.00
		5	TW508	227.50	60.03	32.98	64.10	37.06	187.50
9	5	1	TW109	58.60	24.23	16.22	26.96	18.95	43.00
		2	TW209	93.90	33.48	20.87	36.63	24.03	86.00
		3	TW309	146.40	42.71	25.52	46.29	29.10	129.00
		4	TW409	197.10	56.24	30.77	60.32	34.85	172.50
		5	TW509	238.20	65.47	35.42	69.97	39.93	215.50
TwinLine-W floor-standing cabinets ±/▣									
12	8	1	TW112	78.90	30.62	20.24	33.72	23.33	60.00
		2	TW212	131.70	45.10	28.69	49.02	32.60	120.00
		3	TW312	181.50	57.38	35.05	62.12	39.79	180.00
		4	TW412	226.00	75.29	42.15	80.95	47.82	240.00
		5	TW512	269.40	87.20	48.12	93.70	54.61	300.00
		6	TW612	354.50	99.02	53.98	106.34	61.30	360.00

* General remarks on the determination of the power loss: Values according to DIN EN 61439-1, section 10.10.4.2.2; ambient temperature 35°C, internal temperature 55°C, the allowed device temperature must not be exceeded, levelling of the place of installation ≤ 2000 m altitude; internal form of separation = 1; side walls not covered

Quick product references

Overall dimensions

TwinLine plinth, height 50 mm

External/internal dimensions

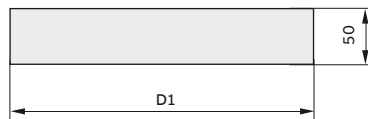
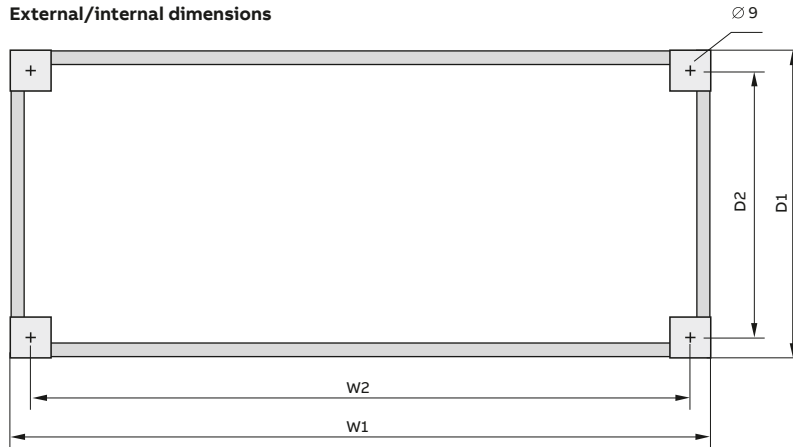

Height mm	Depth mm	Width		External dimensions Width x depth in mm		Internal dimensions Width x depth in mm		Weight in kg
		PW	Type	W1	D1	W2	D2	
TwinLine-G, plinth 50 mm								
50	225	1	TZG105	300	203.5	270	173.5	1.37
		2	TZG205	550	203.5	520	173.5	1.91
		3	TZG305	800	203.5	770	173.5	3.14
		4	TZG405	1050	203.5	1020	173.5	2.93
		5	TZG505	1300	203.5	1270	173.5	3.44
TwinLine-L, plinth 50 mm								
50	275	1	TZL105	300	253.5	270	223.5	1.49
		2	TZL205	550	253.5	520	223.5	2.03
		3	TZL305	800	253.5	770	223.5	2.54
		4	TZL405	1050	253.5	1020	223.5	3.34
		5	TZL505	1300	253.5	1270	223.5	5.78
TwinLine-W, plinth 50 mm								
50	350	1	TZW105	300	328.5	270	298.5	1.67
		2	TZW205	550	328.5	520	298.5	2.21
		3	TZW305	800	328.5	770	298.5	2.72
		4	TZW405	1050	328.5	1020	298.5	5.03
		5	TZW505	1300	328.5	1270	298.5	5.97
		6	TZW605	1550	328.5	1520	298.5	6.90

Quick product references

Overall dimensions

TwinLine plinth, height 100 mm

External/internal dimensions

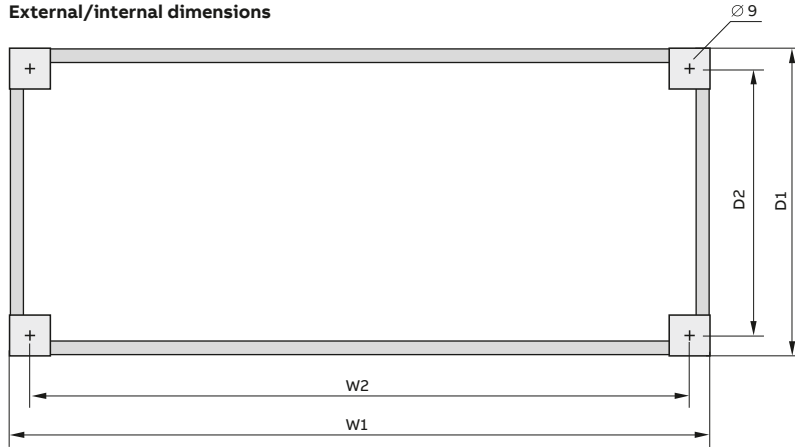

View side knockout
TwinLine-G and -L

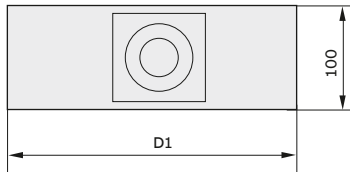

View side knockout
TwinLine-W

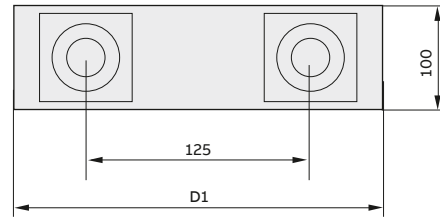

Detail view for side knockout

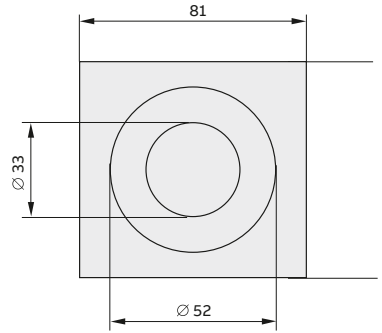

Height mm	Depth mm	Width		External dimensions Width x depth in mm		Internal dimensions Width x depth in mm		Weight in kg
		PW	Type	W1	D1	W2	D2	
TwinLine-G, plinth 100mm								
100	225	1	TZG110	300	203.5	270	173.5	2.22
		2	TZG210	550	203.5	520	173.5	3.06
		3	TZG310	800	203.5	770	173.5	3.87
		4	TZG410	1050	203.5	1020	173.5	4.67
		5	TZG510	1300	204.5	1270	173.5	5.47
TwinLine-L, plinth 100mm								
100	275	1	TZL110	300	253.5	270	223.5	2.41
		2	TZL210	550	253.5	520	223.5	3.24
		3	TZL310	800	253.5	770	223.5	4.05
		4	TZL410	1050	253.5	1020	223.5	6.71
		5	TZL510	1300	254.5	1270	223.5	7.95
TwinLine-W, plinth 100mm								
100	350	1	TZW110	300	328.5	270	298.5	2.68
		2	TZW210	550	328.5	520	298.5	3.52
		3	TZW310	800	328.5	770	298.5	4.32
		4	TZW410	1050	328.5	1020	298.5	6.98
		5	TZW510	1300	329.5	1270	298.5	8.22
		6	TZW610	1550	329.5	1520	298.5	9.45

Quick product references

Overall dimensions

TwinLine doors, height 4 up to 7 GU

External dimensions

For all cabinets of a width of 4 panels and more
Double-wing doors

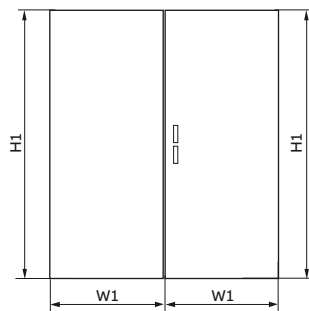

Usable connection area

For all cabinets of a width of 4 panels and more
Double-wing doors

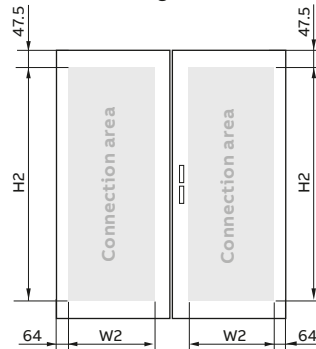

Height		Width		Remark	External dimensions Height x width in mm		External dimensions Height x width in mm		Weight in kg
GU	OH	PW	Type		H1	W1	H2	W2	
TwinLine wall-mounting cabinets, doors									
4	0	1	TZB104		643	289	548	123	5.46
		2	TZB204		643	539	548	373	7.75
		3	TZB304		643	789	548	623	10.11
		4*1	TZB204L	Door left	643	526 *2	548	373	7.77
			TZB204R	Door right	643	539	548	373	7.78
		5*1	TZB304L	Door left	643	776 *2	548	623	10.11
			TZB204R	Door right	643	539	548	373	7.78
		5	1	1	TZB105		793	289	698
2	TZB205				793	539	698	373	9.05
3	TZB305				793	789	698	623	11.85
4*1	TZB205L			Door left	793	526 *2	698	373	9.10
	TZB205R			Door right	793	539	698	373	9.05
5*1	TZB305L			Door left	793	776 *2	698	623	11.89
	TZB205R			Door right	793	539	698	373	9.05
6	2			1	TZB106		943	289	848
		2	TZB206		943	539	848	373	10.32
		3	TZB306		943	789	848	623	13.58
		4*1	TZB206L	Door left	943	526 *2	848	373	10.41
			TZB206R	Door right	943	539	848	373	10.32
		5*1	TZB306L	Door left	943	776 *2	848	623	13.68
			TZB206R	Door right	943	539	848	373	10.32
		7	3	1	TZB107		1093	289	998
2	TZB207				1093	539	998	373	11.69
3	TZB307				1093	789	998	623	15.42
4*1	TZB207L			Door left	1093	526 *2	998	373	11.85
	TZB207R			Door right	1093	539	998	373	11.69
5*1	TZB307L			Door left	1093	776 *2	998	623	15.57
	TZB207R			Door right	1093	539	998	373	11.69

1 4 or more panels wide: double-wing doors

2 Dimensions incl. central door bar

Quick product references

Overall dimensions

TwinLine doors, height 8 up to 12 GU

External dimensions

For all cabinets of a width of 4 panels and more
Double-wing doors

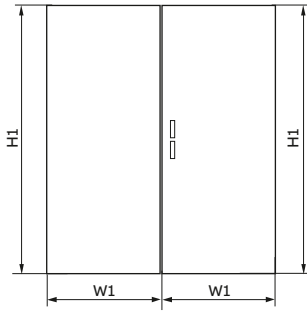

Usable connection area

For all cabinets of a width of 4 panels and more
Double-wing doors

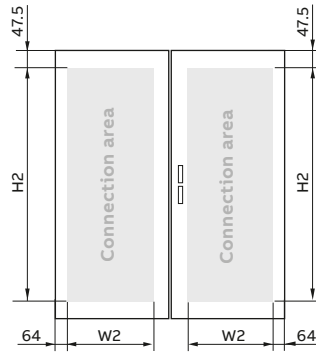

Height		Width		External dimensions		External dimensions		Weight		
GU	OH	PW	Type	Remark	Height x width in mm	Height x width in mm	in kg			
		H1	W1		H2	W2				
TwinLine wall-mounting cabinets, doors										
8	4	1	TZB108		1243	289	1148	123	8.75	
		2	TZB208		1243	539	1148	373	12.96	
		3	TZB308		1243	789	1148	623	17.15	
	4*		TZB208L	Door left	1243	526 * ²	1148	373	13.17	
			TZB208R	Door right	1243	539	1148	373	12.96	
	5*		TZB308L	Door left	1243	776 * ²	1148	623	17.36	
			TZB208R	Door right	1243	539	1148	373	12.96	
	9	5	1	TZB109		1393	289	1298	123	9.55
2			TZB209		1393	539	1298	373	14.23	
3			TZB309		1393	789	1298	623	18.88	
4*				TZB209L	Door left	1393	526 * ²	1298	373	14.49
				TZB209R	Door right	1393	539	1298	373	14.23
5*				TZB309L	Door left	1393	776 * ²	1298	623	19.14
				TZB209R	Door right	1393	539	1298	373	14.23
TwinLine floor-standing cabinets, doors										
12	8	1	TZB112		1843	289	1748	123	11.96	
		2	TZB212		1843	539	1748	373	18.07	
		3	TZB312		1843	789	1748	623	24.08	
		4*		TZB212L	Door left	1843	526 * ²	1748	373	18.45
				TZB212R	Door right	1843	539	1748	373	18.03
		5*		TZB312L	Door left	1843	776 * ²	1748	623	24.49
				TZB212R	Door right	1843	539	1748	373	18.03
		6*		TZB312L	Door left	1843	776 * ²	1748	623	24.49
				TZB312R	Door right	1843	789	1748	623	24.08

*Double-wing doors for all cabinets of a width of 4 panels and more

*² Dimensions incl. central door bar

Quick product references

Overall dimensions

TwinLine Transparent doors, height 4 up to 7 GU

External dimensions

For all cabinets of a width of 4 panels and more
Double-wing doors

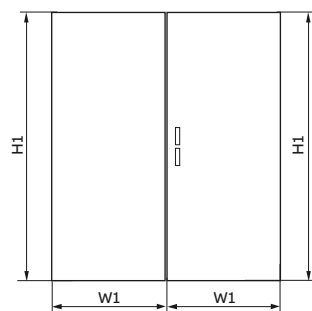

Dimensions of viewing area

For all cabinets of a width of 4 panels and more
Double-wing doors

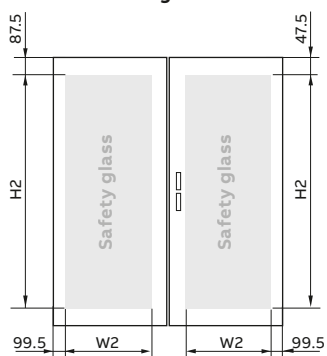

Height GU	Width OH	PW	Type	Remark	External dimensions Height x width in mm		Viewing area Height x width in mm		Weight in kg
					H1	W1	H2	W2	
TwinLine wall-mounting cabinets, doors									
4	0	2	TZT204		643	539	468	340	6.40
		3	TZT304		643	789	468	590	8.70
		4 ^{*1}	TZT204L	Door left	643	526 ^{*2}	468	340	6.50
			TZT204R	Door right	643	539	468	340	6.50
		5 ^{*1}	TZT304L	Door left	643	776 ^{*2}	468	590	8.40
			TZT204R	Door right	643	539	468	340	6.50
5	1	2	TZT205		793	539	618	340	7.60
		3	TZT305		793	789	618	590	10.20
		4 ^{*1}	TZT205L	Door left	793	526 ^{*2}	618	340	7.40
			TZT205R	Door right	793	539	618	340	7.50
		5 ^{*1}	TZT305L	Door left	793	776 ^{*2}	618	590	9.90
			TZT205R	Door right	793	539	618	340	7.50
6	2	2	TZT206		943	539	768	340	8.70
		3	TZT306		943	789	768	590	11.50
		4 ^{*1}	TZT206L	Door left	943	526 ^{*2}	768	340	8.50
			TZT206R	Door right	943	539	768	340	8.60
		5 ^{*1}	TZT306L	Door left	943	776 ^{*2}	768	590	11.40
			TZT206R	Door right	943	539	768	340	8.60
7	3	2	TZT207		1093	539	918	340	10.00
		3	TZT307		1093	789	918	590	13.00
		4 ^{*1}	TZT207L	Door left	1093	526 ^{*2}	918	340	9.70
			TZT207R	Door right	1093	539	918	340	9.80
		5 ^{*1}	TZT307L	Door left	1093	776 ^{*2}	918	590	13.00
			TZT207R	Door right	1093	539	918	340	9.80

^{*1} 4 or more panels wide: double-wing doors

^{*2} Dimensions incl. central door bar

Quick product references

Overall dimensions

TwinLine Transparent doors, height 8 up to 12 GU

External dimensions
For all cabinets of a width of 4 panels
and more Double-wing doors

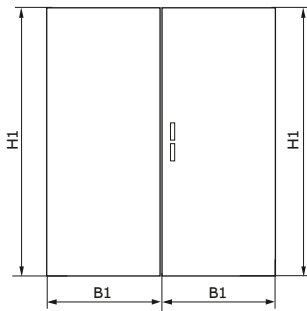

Dimensions of viewing area
For all cabinets of a width of 4 panels
and more Double-wing doors

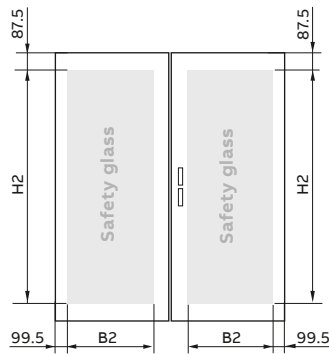

Height		Width			External dimensions Height x width in mm		Viewing area Height x width in mm		Weight
GU	OH	PW	Type	Remark	H1	W1	H2	W2	in kg
TwinLine wall-mounting cabinets, doors									
8	4	2	TZB208		1243	539	1068	340	11.10
		3	TZB308		1243	789	1068	590	14.60
	4*	TZB208L	Door left	1243	526 * ²	1068	340	10.90	
		TZB208R	Door right	1243	539	1068	340	11.10	
	5*	TZB308L	Door left	1243	776 * ²	1068	590	14.60	
		TZB308R	Door right	1243	539	1068	340	11.10	
9	5	2	TZB209		1393	539	1218	340	12.20
		3	TZB309		1393	789	1218	590	16.10
	4*	TZB209L	Door left	1393	526 * ²	1218	340	12.00	
		TZB209R	Door right	1393	539	1218	340	11.50	
	5*	TZB309L	Door left	1393	776 * ²	1218	590	16.00	
		TZB309R	Door right	1393	539	1218	340	11.50	
TwinLine floor-standing cabinets, doors									
12	8	2	TZB212		1843	539	1668	340	15.60
		3	TZB312		1843	789	1668	590	20.70
	4*	TZB212L	Door left	1843	526 * ²	1668	340	15.60	
		TZB212R	Door right	1843	539	1668	340	15.40	
	5*	TZB312L	Door left	1843	776 * ²	1668	590	20.70	
		TZB312R	Door right	1843	539	1668	340	15.40	
	6*	TZB312L	Door left	1843	776 * ²	1668	590	20.70	
		TZB312R	Door right	1843	789	1668	590	19.90	

*Double-wing doors for all cabinets of a width of 4 panels and more

*²Dimensions incl. central door bar

Quick product references

Overall dimensions

TwinLine mounting plates

External dimensions / Usable connection area

Mounting plate

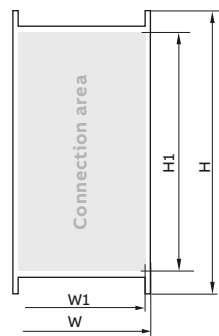

Height		Width		External dimensions in mm		Connection area in mm		Weight
GU	OH	PW	Type	H	W	H1	W1	in kg
Mounting plates for TwinLine wall-mounting cabinets \pm								
4	0	1	TZM104	600	246	522	160	3.51
		2	TZM204	600	496	522	410	5.79
		3	TZM304	600	746	522	660	8.07
		4	TZM404	600	996	522	910	10.35
		5	TZM504	600	1246	522	1160	12.62
5	1	1	TZM105	750	246	672	160	4.43
		2	TZM205	750	496	672	410	7.30
		3	TZM305	750	746	672	660	10.17
		4	TZM405	750	996	672	910	13.03
		5	TZM505	750	1246	672	1160	15.90
6	2	1	TZM106	900	246	822	160	5.35
		2	TZM206	900	496	822	410	8.80
		3	TZM306	900	746	822	660	12.26
		4	TZM406	900	996	822	910	15.72
		5	TZM506	900	1246	822	1160	19.20
7	3	1	TZM107	1050	246	972	160	6.26
		2	TZM207	1050	496	972	410	10.31
		3	TZM307	1050	746	972	660	14.36
		4	TZM407	1050	996	972	910	18.40
		5	TZM507	1050	1246	972	1160	22.45
8	4	1	TZM108	1200	246	1122	160	7.18
		2	TZM208	1200	496	1122	410	11.82
		3	TZM308	1200	746	1122	660	16.45
		4	TZM408	1200	996	1122	910	21.09
		5	TZM508	1200	1246	1122	1160	25.72
9	5	1	TZM109	1350	246	1272	160	8.10
		2	TZM209	1350	496	1272	410	13.33
		3	TZM309	1350	746	1272	660	18.55
		4	TZM409	1350	996	1272	910	23.77
		5	TZM509	1350	1246	1272	1160	29.00
Mounting plates for TwinLine floor-standing cabinets \pm								
12	8	1	RM18	1800	246	1722	160	10.80
		2	RM28	1800	496	1722	410	17.80
		3	RM38	1800	746	1722	660	21.00
		4	RM48	1800	996	1722	910	31.80

Quick product references

Overall dimensions

TwinLine Assembly with mounting plate

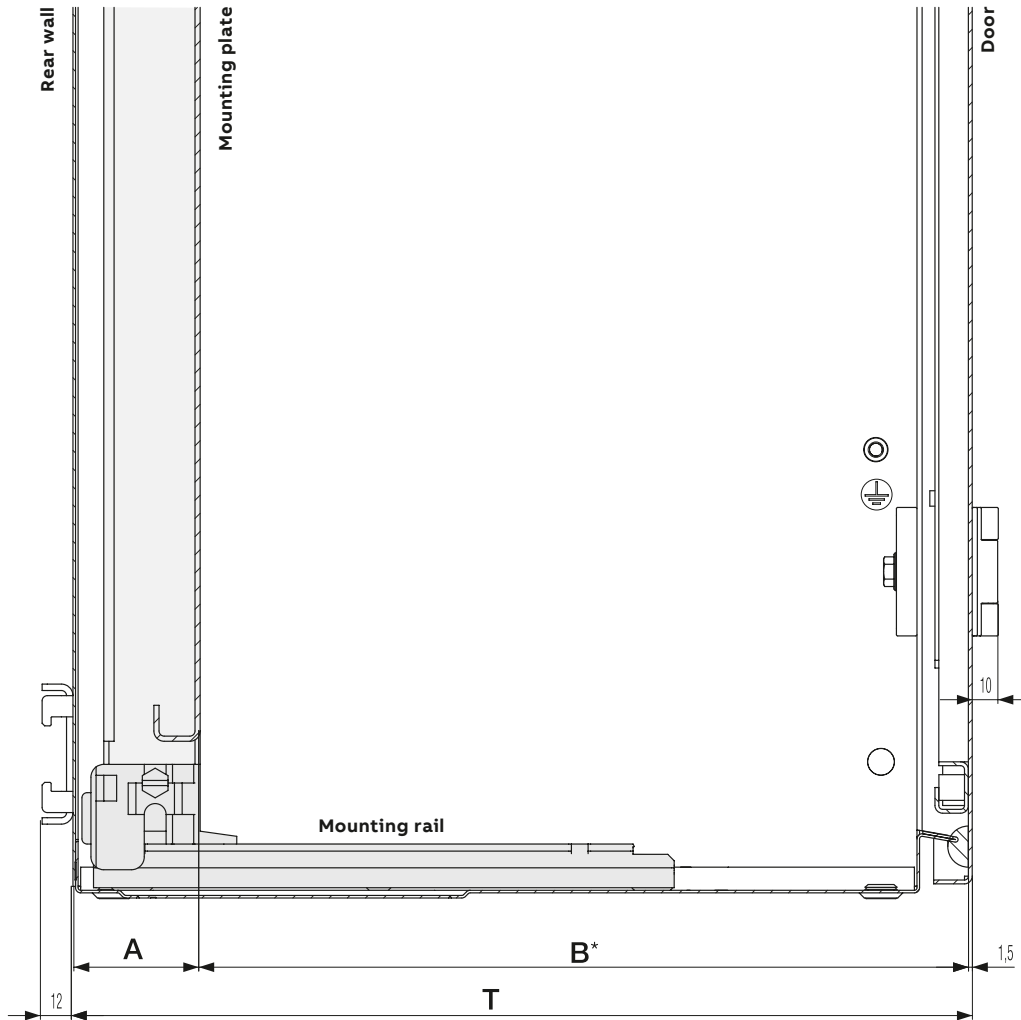

Mounting rail
Top view

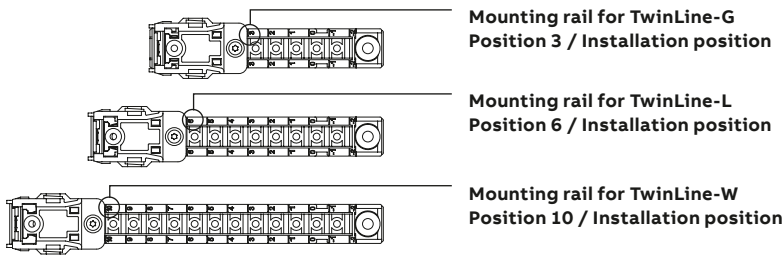

		A in mm for installation position													
Cabinet series	Depth in mm	10	9	8	7	6	5	4	3	2	1	0	-1	-2	
TwinLine G	225	-	-	-	-	-	-	-	52.5	65	77.5	90	102.5	115	
TwinLine L	275	-	-	-	-	50	62.5	75	87.5	100	112.5	125	137.5	150	
TwinLine W	350	48.5	61	73.5	86	98.5	111	123.5	136	148.5	161	173.5	186	198.5	
		B* in mm for installation position													
Cabinet series	Depth in mm														
TwinLine G	225	-	-	-	-	-	-	-	170	157.5	145	132.5	120	107.5	
TwinLine L	275	-	-	-	-	222.5	210	197.5	185	172.5	160	147.5	135	122.5	
TwinLine w	350	299	286.5	274	261.5	249	236.5	224	211.5	199	186.5	174	161.5	149	

* Referred to the surface of the connection area; (see page155); outside the connection area this dimension is reduced by 35 mm
> Dimensions in mm

Quick product references

Overall dimensions

CombiLine modules on EDF mounting frame

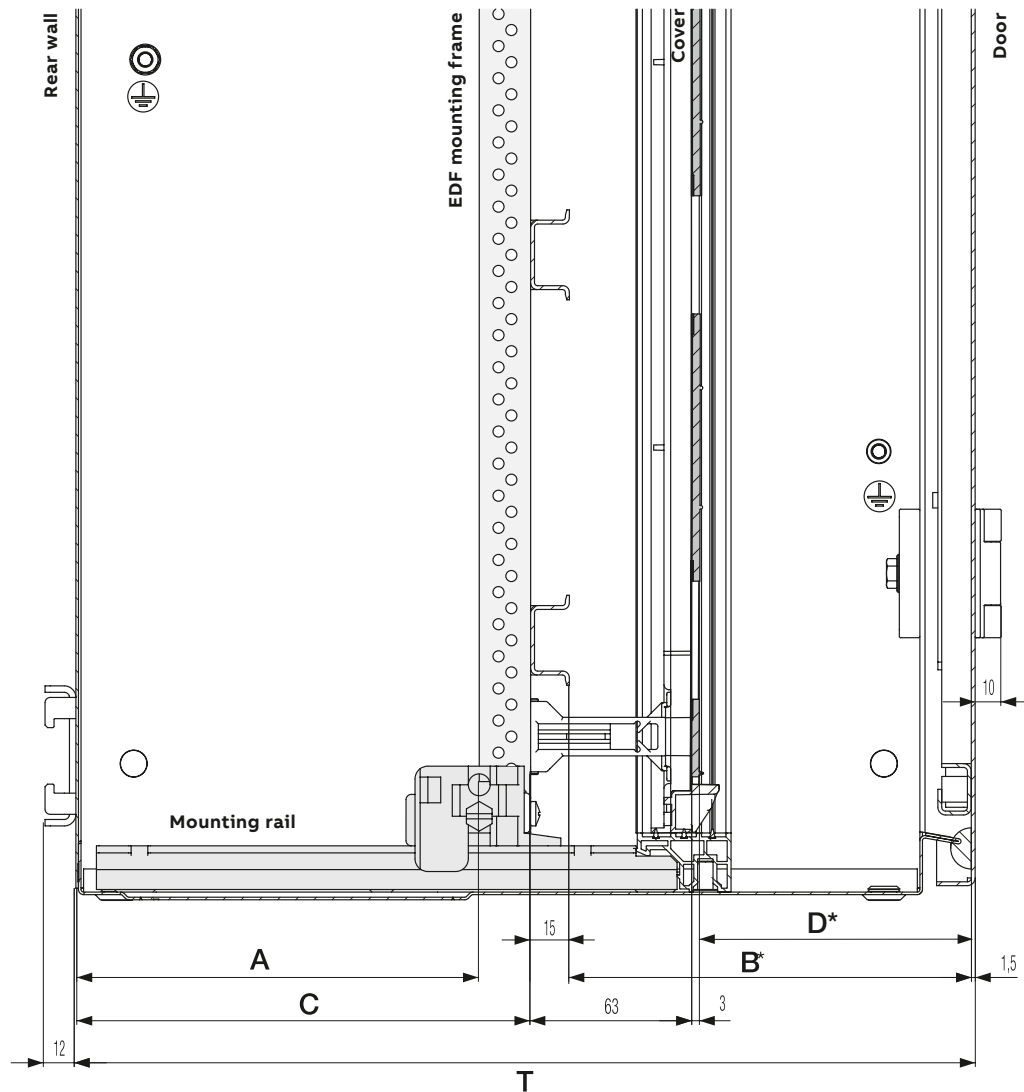

Mounting rail
Top view

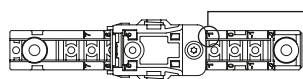

Mounting rail
Position 1

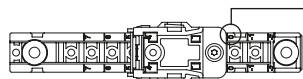

Mounting rail
Position 0 / as delivered / Installation position

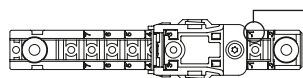

Mounting rail
Position -1

Cabinet series	Depth in mm	A in mm for installation part position			B in mm for installation position*			C in mm for installation position			D in mm for installation position*		
		1	0	-1	1	0	-1	1	0	-1	1	0	-1
TwinLine-G	225	60	72.5	85	127.5	115	102.5	80	92.5	105	76.5	64	51.5
TwinLine-L	275	95	107.5	120	142.5	130	117.5	115	127.5	140	91.5	79	66.5
TwinLine-W	350	143.5	156	168.5	169	156.5	144	163.5	176	188.5	117.5	105	92.5

* Referred to the surface of the connection area (see page 156); outside the connection area this dimension is reduced by 35 mm
> Dimensions in mm

Quick product references

Overall dimensions

CombiLine modules on WR mounting frame

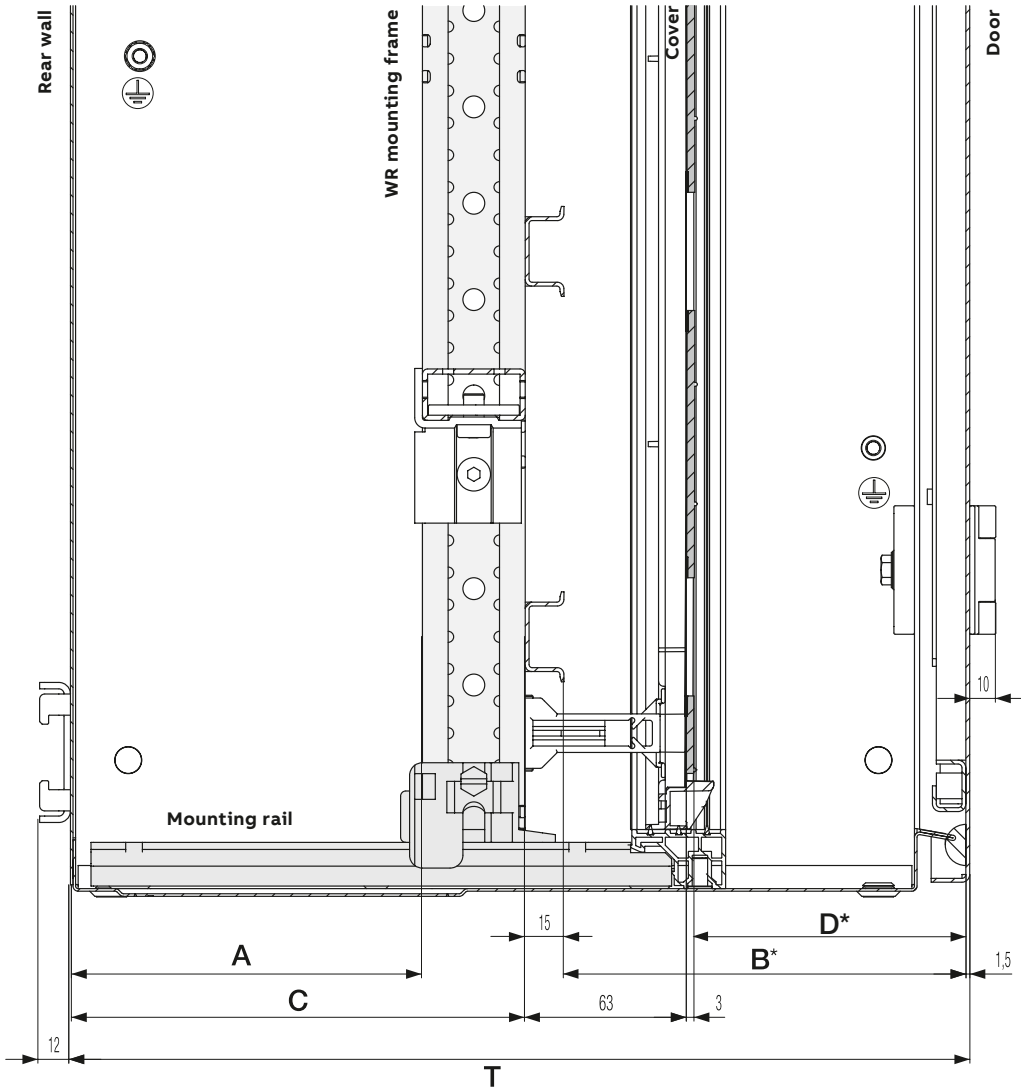

Mounting rail
Top view

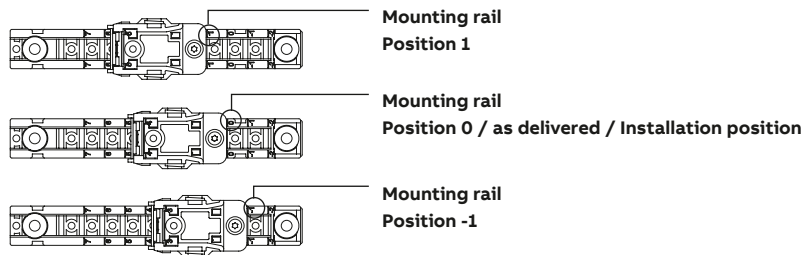

Schrankserie	Depth in mm	A in mm for installation part position			B in mm for installation position*			C in mm for installation position			D in mm for installation position*		
		1	0	-1	1	0	-1	1	0	-1	1	0	-1
TwinLine-G	225	40	52.5	65	127.5	115	102.5	80	92.5	105	76.5	64	51.5
TwinLine-L	275	75	87.5	100	142.5	130	117.5	115	127.5	140	91.5	79	66.5
TwinLine-W	350	123.5	136	148.5	169	156.5	144	163.5	176	188.5	117.5	105	92.5

* Referred to the surface of the connection area (see page 157); outside the connection area this dimension is reduced by 35 mm
> Dimensions in mm

Quick product references

Overall dimensions

Assembly with meter panel for TwinLine-G

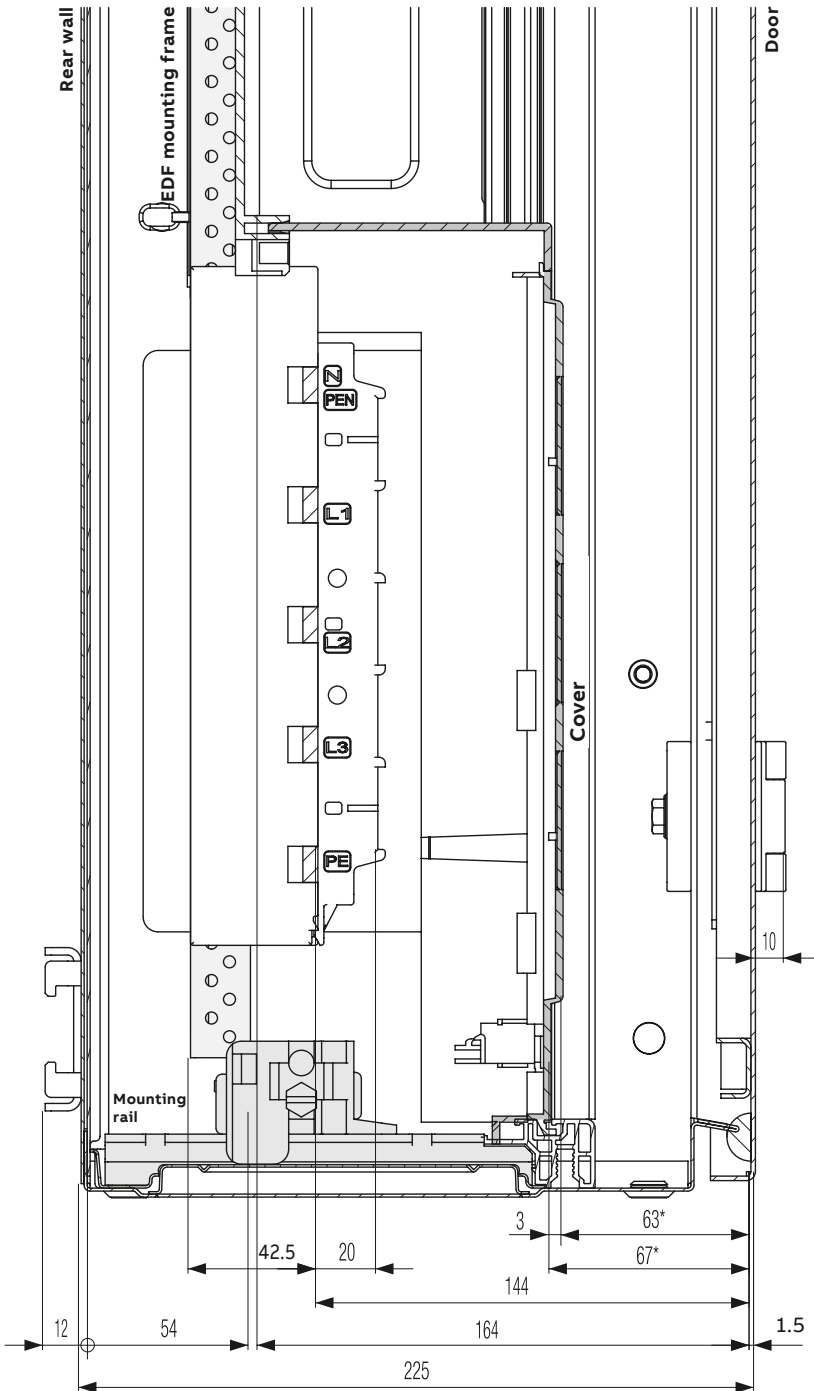

Mounting rail
Top view

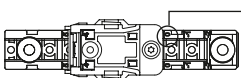

Mounting rail
Position 0 / as delivered

* Referred to the surface of the connection area (see page 159); outside the connection area this dimension is reduced by 35 mm
> Dimensions in mm

Quick product references

Overall dimensions

TwinLine Top view / side flange knockout, top and bottom

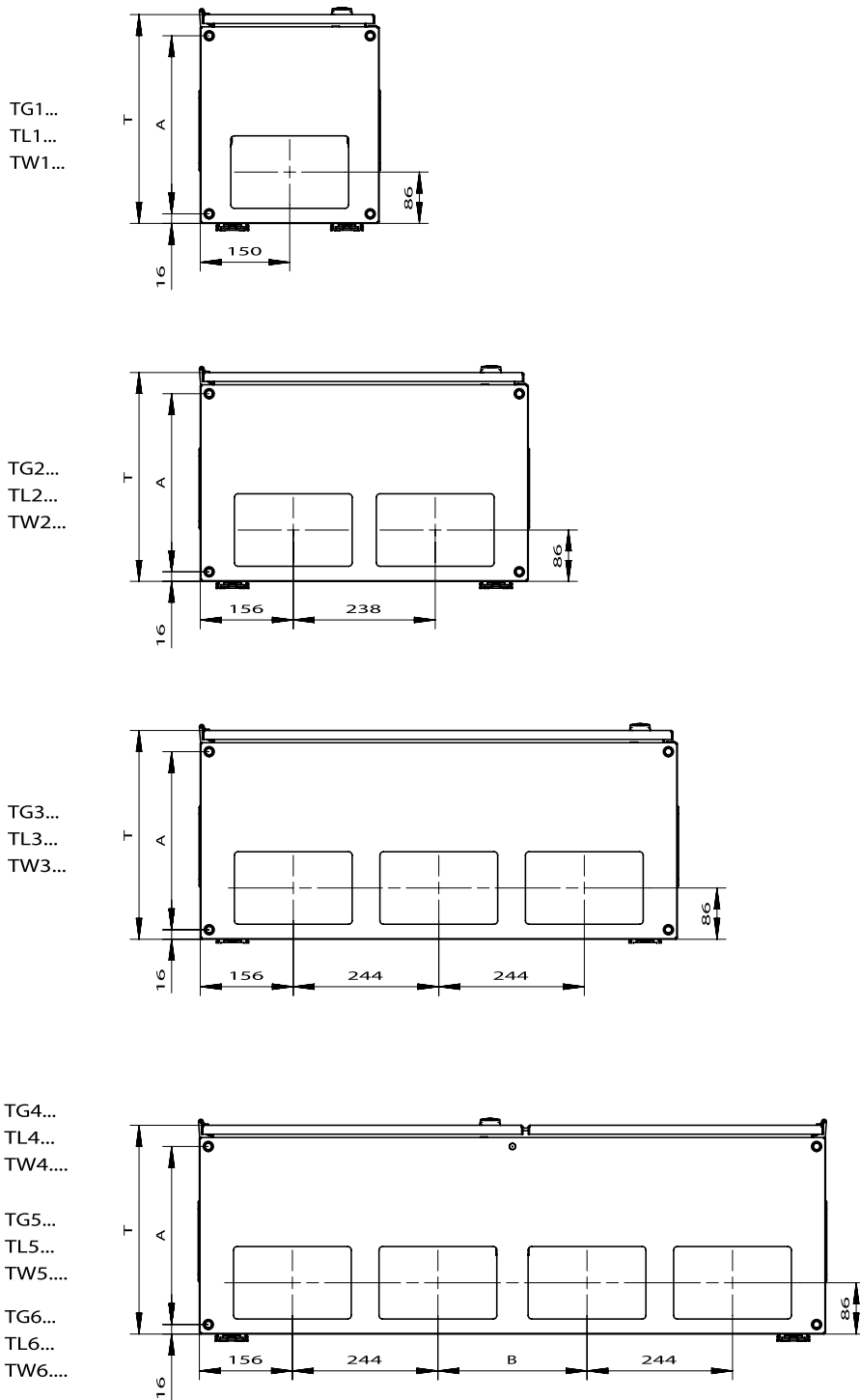

Cabinet series	Depth in mm	A in mm	B in mm / 4 panel wide	B in mm / 5 panel wide	B in mm / 6 panel wide
TwinLine-G	225	173.5			
TwinLine-L	275	223.5	1 x 250 (250)	2 x 250 (500)	3 x 250 (750)
TwinLine-W	350	298.5			

Quick product references

Overall dimensions

TwinLine Side view / side flange knockout, top and bottom

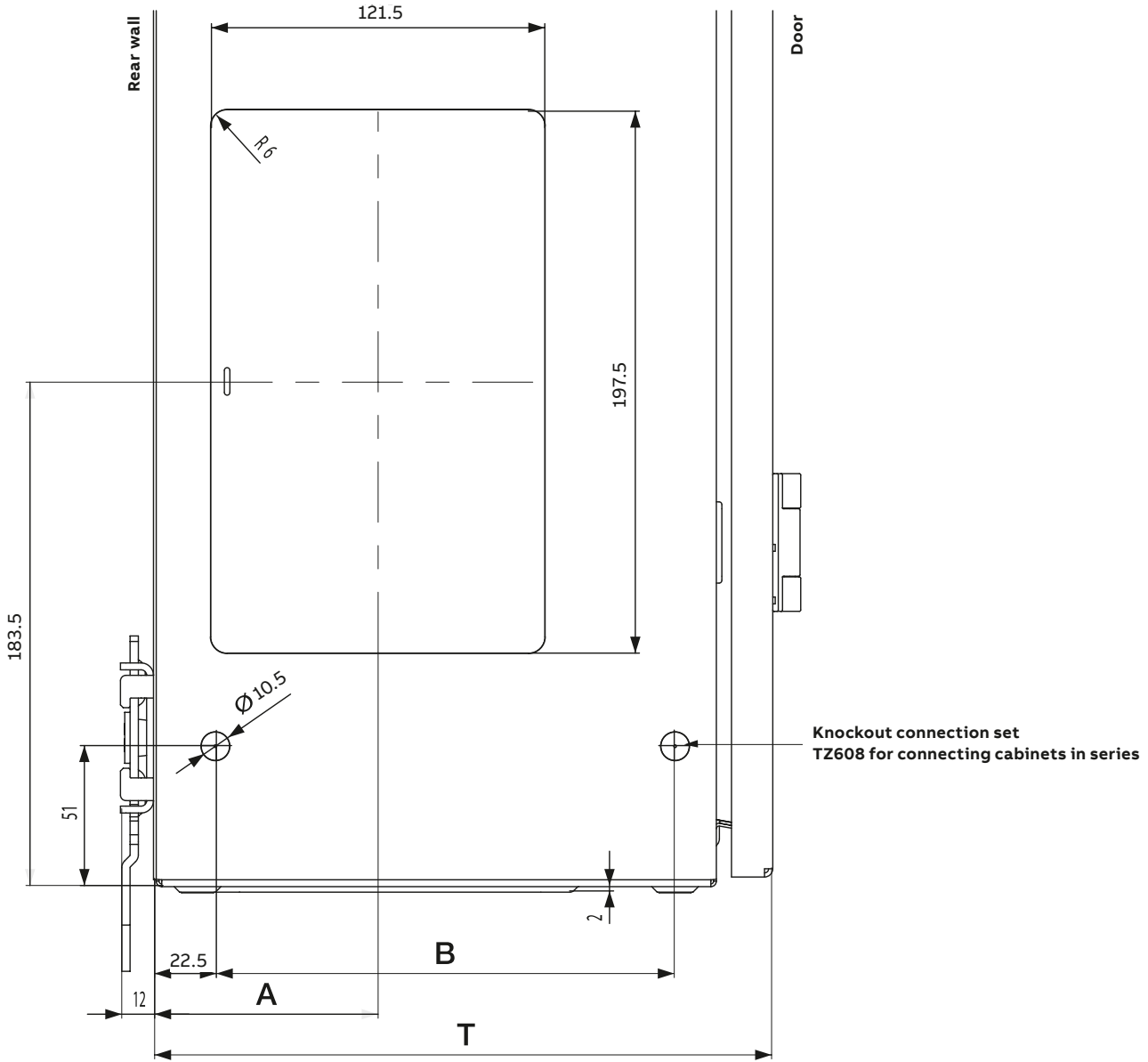

Cabinet series	Depth in mm	A in mm	B in mm
TwinLine-G	225	80.5	167
TwinLine-L	275	106.5	217
TwinLine-W	350	154.5	292

Quick product references

MCBs and RCDs worldwide marks and approvals







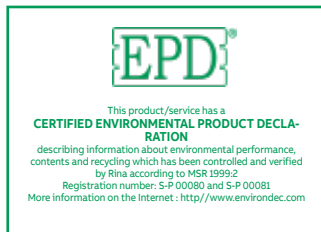

This is the present situation regarding worldwide marks and approvals for ABB System pro M compact range devices.

Although some products already obtained some approvals or certificates, they don't necessarily bear the related marks on the product.

For detailed list of approval, please check our product detail page and download section

The F 200 range has obtained the EPD (Environmental Product Declaration), according to ISO 14040.



				
	AENOR - Spain	BBJ - Poland	BSMI - Taiwan	CCC - China
				
S 200	■ S 200	■ S 200	■ S 200	■ S 200
S 200M	■ S 200M	■ S 200M	■ S 200M	■ S 200M
S 200M UC				
S 200 P	■ S 200 P	■ S 200 P		■ S 200 P
S 300 P			■ S 300 P	■ S 300 P
S 200 S				
S 200 U				■ S 200 U
S 200 UP				■ S 200 UP
S 200 UDC				
S 200 MR / S 200 PR				
SU 200 MR / SU 200 PR				
SN 201				■ SN 201
S 200 80 - 100 A				■ S 200 80 - 100 A
S 750 DR				
S400M				■ S400M ^⑩
S 800*				■ S 800
F 200	■ F 200		■ F 200 ^③	■ F 200 ^③
F-ATI Test				
F-ARI Test				
DDA 200				
DS 200				
DS201				■ DS201
DS301C				■ DS301C
DS202CR				■ DS202CR
DS203NC				■ DS203NC
DDA 800				
SN201-S, SN201-IH				■ SN201-S, SN201-IH
DS401/402				■ DS401/402
S200C				■ S200C

Legend:

■ Approved

● Waiting for approval

① Supplementary protection













② Branch circuit protection

③ Available for F200 type for overseas markets

⑤ Only DS202C M Type A and APR









The indicated approvals generally cover all available approvals worldwide. To verify the approval status in your country please contact your LSO.

* For further details on worldwide marks & approvals for specific S800 ranges please visit the dedicated download section in our websites.

					
CEBEC - Belgium	CERTIF - Portugal	CSA - Canada	DEMKO - Denmark	EZO - Czech Republic	FIMKO - Finland
					
■ S 200	■ S 200		■ S 200	■ S 200	■ S 200
■ S 200M	■ S 200M	■ S 200M ①	■ S 200M	■ S 200M	■ S 200M
■ S 200 P	■ S 200 P	■ S 200 P (≤ 25 A) ①	■ S 200 P	■ S 200 P	■ S 200 P
■ S 300 P	■ S 300 P	■ S 300 P ①		■ S 300 P	■ S 300 P
		■ S 200 U ②			
		■ S 200 UP ②			
		■ S 200 UDC ②			
		■ S 200 MR / S 200 PR ①			
		■ SU 200 MR / SU 200 PR ②			
■ F 200	■ F 200				■ F 200
		■ DS201 UL			
■ DS301C					

Quick product references

MCBs and RCDs worldwide marks and approvals













				
	EAC - Russia	IIS - Israel	IMQ - Italy	IMQ CSV - Italy
				
S 200	■ S 200	■ S 200	■ S 200	
S 200M	■ S 200M		■ S 200M	
S 200M UC				
S 200 P	■ S 200 P		■ S 200 P	
S 300 P	■ S 300 P		■ S 300 P	
S 200 S			● S 200 S	
S 200 U				
S 200 UP				
S 200 UDC				
S 200 MR / S 200 PR				
SU 200 MR / SU 200 PR				
SN 201		■ SN 201	■ SN 201	
S 200 80 - 100 A	■ S 200 80 - 100 A		■ S 200 80 - 100 A	
S 750 DR	■ S 750 DR			
S400M	■ S400M			
S 800*	■ S 800			
F 200	■ F 200	■ F 200	■ F 200	
F-ATI Test				
F-ARI Test				■ F-ARI Test
DDA 200	■ DDA 200	■ DDA 200	■ DDA 200	
DS 200	■ DS 200	■ DS 200	■ DS 200	
DS201	■ DS201	■ DS201	■ DS201	
DS301C			■ DS301C	
DS202CR			■ DS202CR	
DS203NC	■ DS203NC	■ DS203NC	■ DS203NC	
DDA 800				
F2C..	■ F2C..			
S 290 accessories	■ S 290 accessories			
DS401/402	■ DS401/402			
S-ARC1	■ S-ARC1		■ S-ARC1	
DS-ARC1	■ DS-ARC1		■ DS-ARC1	
S200C			■ S200C	

Legend:

- Approved
- Waiting for approval
- ① Supplementary protection
- ② Branch circuit protection
- ③ Available for F200 type for overseas markets
- ④ Only S 500-K range
- ⑤ Only DS202C M Type A and APR
- ⑥ Not available for F200 left neutral
- ⑦ Only DS201 (2019) APR and DS201 neutral left series









The indicated approvals generally cover all available approvals worldwide. To verify the approval status in your country please contact your LSO.

* For further details on worldwide marks & approvals for specific S800 ranges please visit the dedicated download section in our websites.

					
IRAM - Argentina	KC - South Korea	KEMA - Netherland	LCIE - France	NEMKO - Norway	OVE - Austria
					
■ S 200	■ S 200	■ S 200	■ S 200	■ S 200	■ S 200
		■ S 200M	■ S 200M	■ S 200M	■ S 200M
		■ S 200 P	■ S 200 P	■ S 200 P	■ S 200 P
	■ S 300 P	■ S 300 P	■ S 300 P	■ S 300 P	■ S 300 P
		● S 200 S	■ S 200 S		■ S 200 S
		■ SN 201	■ SN 201		
■ F 200 ③	■ S 800	■ F 200	■ F 200		■ F 200
			■ DDA 200		
			■ DS 200		
	■ DS201	■ DS201	■ DS201 ⑦		■ DS201
		■ DS301C	■ DS301C		■ DS301C
	■ DS202CR		■ DS202CR		
		■ DS203NC			
■ S-ARC1	■ S-ARC1				
	■ DS-ARC1				
■ S200C		■ S200C	■ S200C		

Quick product references

MCBs and RCDs worldwide marks and approvals











				
	HDB/PSB - Singapore	SABS - South Africa	SEMKO - Sweden	SEV - Switzerland
				
S 200	■ S 200	■ S 200	■ S 200	■ S 200
S 200M	■ S 200M		■ S 200M	■ S 200M
S 200M UC				
S 200 P			■ S 200 P	■ S 200 P
S 300 P			■ S 300 P	■ S 300 P
S 200 S				● S 200 S
S 200 U				
S 200 UP				
S 200 UDC				
S 200 MR / S 200 PR				
SU 200 MR / SU 200 PR				
SN 201				
S 200 80 - 100 A		■ S 200 80 - 100 A		
S 700				
S 750 DR				
S400E				■ S400E
S400M				■ S400M
S 800*				■ S 800
F 200	■ F 200 ③	■ F 200 ③		■ F 200
F-ATI Test				
F-ARI Test				
DDA 200		■ DDA 200		
DS 200				
DS201				■ DS201
DS301C				■ DS301C
DS202CR				
DS203NC				
DSE201 - DSE201 M				
DDA 800				
DS401/402			■ DS401/402	■ DS401/402
S-ARC1				
DS-ARC1				
S200C				

Legend:

- Approved
- Waiting for approval
- ① Supplementary protection
- ② Branch circuit protection
- ③ Available for F200 type for overseas markets
- ④ Only S 500-K range
- ⑤ Only DS202C M Type A and APR
- ⑥ not available for F200 left neutral







The indicated approvals generally cover all available approvals worldwide. To verify the approval status in your country please contact your LSO.

* For further details on worldwide marks & approvals for specific S800 ranges please visit the dedicated download section in our websites.

					
SIQ - Slovenia	SIRIM - Malaysia	UL - USA			VDE - Germany
					
■ S 200	■ S 200		■ S 200 ①		■ S 200
■ S 200M	■ S 200M	■ S 200M ①			■ S 200M
					■ S 200M UC
■ S 200 P			■ S 200 P ①		■ S 200 P
			■ S 300 P ①		■ S 300 P
					■ S 200 S
				■ S 200 U ②	
				■ S 200 UP ②	
				■ S 200 UDC ②	
		■ S 200 MR / S 200 PR ①			■ S 200 MR / S 200 PR
				■ SU 200 MR / SU 200 PR ②	■ SU 200 MR / SU 200 PR
					■ S 700
					■ S 750 DR
					■ S400E
					■ S400M ⑩
		■ S 800		■ S 800	■ S 800
	■ F 200 ③	■ F 200 ④			■ F 200
					■ F-ATI Test
					■ DS 200
		■ DS201 UL			■ DS201
					■ DS301C
					■ DS202CR
					■ DS203NC
					■ DS401/402
					■ S-ARC1
					■ DS-ARC1
					■ S200C

Quick product references

MCBs and RCDs worldwide marks and approvals







RIVER	MARINE	MARINE
		
RRR - Russia	ABS - USA	DNV-GL - Germany
		
S 200	■ S 200	■ S 200
S 200M	■ S 200M	■ S 200M
S 200 MUC		
S 200 P		
S 300 P		■ S 300 P
S 200 S		
S 200 U		
S 200 UP		
S 200 UDC		
S 200 MR / S 200 PR		
SU 200 MR / SU 200 PR		
SN 201		■ SN 201
S 200 80 - 100 A		
S 700		
S 750 DR		
S400E		
S400M		■ S400M
S 800*		■ S 800
F 200		■ F 200 ③
F 204 B		
F-ATI Test		
F-ARI Test		
DDA 200		
DS 200		
DS201	■ DS201, DS201 M, DS201 M 110 V	■ DS201, DS201 M, DS201 M 110 V
DS301C		
DS202CR	■ DS202CR M, DS202CR M 110 V	■ DS202CR M, DS202CR M 110 V
DS203NC		
DSE201 - DSE201 M		■ DSE201 - DSE201 M
DS 271		
DDA 800		
S200C		

Legend:

- Approved
- Waiting for approval
- ① Supplementary protection
- ② Branch circuit protection
- ③ Available for F200 type for overseas markets
- ④ Only DS202C M Type A and APR
- ⑤ Not available for F200 left neutral



















The indicated approvals generally cover all available approvals worldwide. To verify the approval status in your country please contact your LSO.

* For further details on worldwide marks & approvals for specific S800 ranges please visit the dedicated download section in our websites.

MARINE	MARINE	MARINE
		
LRS - Great Britain	RINA - Italy	RMRS - Russia
		
■ S 200	■ S 200	■ S 200
■ S 200M	■ S 200M	■ S 200M
■ S 200 P	■ S 200 P	■ S 200 P
■ S 300 P	■ S 300 P	■ S 300 P
■ S 800	■ S 800	■ S 800
	■ DDA 200 110 V	■ DS 200
	■ DS201 M 110 V	■ DS201, DS201 M, DS201 M 110 V
	■ DS202CR M, DS202CR M 110 V	
■ S200C	■ S200C	





















Quick product references

MDRCs worldwide marks and approvals

									
	BSI UK	CCC China	CEBEC Belgium	ENEC Europe	EAC Russia	GOST Russia	IMQ Italy	KEMA Netherland	NF France
									
OVR		■ OVR QS for AC (CQC)			■ OVR T1-T2, T2 and T2-T3	■ OVR T2			■ OVR T1-T2, T2 and T2-T3
eOVR		■ eOVR (CQC)							
RD						■ RD			
TR-TRM						■ TR-TRM			
E 90		■ E90 ③, E90h ③, E90 PV*			■ E90, E90h, E90 PV*		■ E90 ③, E90h ③		■ E90 ⑤, E90h ⑥
E90 50/125		■ E90 50/125			■ E90 50/125				
E90									
E 200		■ E 200			■ E 200			■ E 200	
SD 200		■ SD 200			■ SD 200			■ SD 200	
SHD 200		■ SHD 200			■ SHD 200			■ SHD 200	
E210		■ E210 ②			■ E210				
ESB		■ ESB							
EN		■ EN							
E290					■ E290				
E297					■ E297				
E 260					■ E 260				
E 234		■ E 234				■ E 234			
AG					■ AG				
DBT					■ DBT				
E 232					■ E 232				

Legend:

- Approved whole range
- Waiting for approval
- ① Except for ESB/EN 20
- ② For series E219 CCC mark not needed
- ③ Just no LED versions
- ⑤ Version without neutral
- ⑥ Dedicated range with neutral on left
- ⑦ IMQ available for TM up to 30 VA
- ⑧ VDE available only on M1175 (standard grey version) and M1175-C (with cover)
- * E90 PV 1000 V DC only

									
SEV Swiss	UL/CSA USA/Canada	UL/CSA USA/Canada	VDE Germany	BV/F France	GL/D Germany	LRS Great Britain	RINA Italy	RMRS Russia	KR Korea
									

■ OVR T2
40 275

■ E90 PV, E90 CC	■ E90		■ E90, E90h, E90 PV*	■ E90 ③, E90h ③	■ E90 ③, E90h ③	■ E90
	■ E90 50/125		■ E90 50/125	■ E90 50/125	■ E90 50/125	
■ E90 J						
		■ E 200				
		■ SD 200				
		■ SHD 200				
	■ E210	■ E210				
	■ ESB		■ ESB ①	■ ESB ①		
	■ EN		■ EN ①	■ EN ①		
		■ E290			■ E290 60Hz	
		■ E297				
				■ E 260		
	■ E 234					
		■ E 232				

Quick product references

MDRCs worldwide marks and approvals

        	
        	
TL Line	■ TL Line
LCR	■ LCR
SQZ3	■ SQZ3
CT / CTA / TRFM	■ CT/CTA/ TRFM
MCA/MCV	■ MCA/MCV
HMT	■ HMT
TM	■ TM ■ TM ②
TS	■ TS
TS-C	■ TS-C
TSM/TSR	■ TSM/TSR
SM/RM	■ SM/RM
M1170	■ M1170
M1173	■ M1173 ■ M1173
M1174	■ M1174 ■ M1174
M1175	■ M1175
M1363	■ M1363
M1011	
TM-C, TM-I, TM-S	■ TM-C, TM-I, TM-S ■ TM-C, TM-I, TM-S

Legend:

- Approved whole range
- Waiting for approval
- ① Except for ESB/EN 20
- ② For series E219 CCC mark not needed
- ③ Just no LED versions
- ④ Dedicated range for chinese market
- ⑤ Version without neutral
- ⑥ Dedicated rang with neutral on left
- ⑦ E291S in preparation: will be available in 2016



SEV
Swiss



UL/CSA
USA/Canada



UL/CSA
USA/Canada



VDE
Germany



BV/F
France



GL/D
Germany



LRS
Great Britain



RINA
Italy



RMRS
Russia



KR
Korea



■ TS

■ M1175 ⑧

■ M1011

■ TM-C, TM-I, TM-S

■ TM-C