

—
SAFETY PRODUCTS

Tina 3A/3Aps Adapter unit Product Manual



Read and understand this document

Please read and understand this document before using the products. Please consult ABB with any questions or comments.

Suitability for use

ABB shall not be responsible for conformity with any standards, codes, or regulations that apply to the combination of products in the customer's application or use of the product. Third party certificates for the products are available at <https://new.abb.com/low-voltage/products/safety-products>. This information by itself is not sufficient for a complete determination of the suitability of the products in combination with the end product, machine, system, or other application or use.

The following are some examples of applications for which particular attention must be given. This is not intended to be an exhaustive list of all possible uses of the products, nor is it intended to imply that the uses listed may be suitable for the products:

- Outdoor use, uses involving potential chemical contamination or electrical interference, or conditions or uses not described in this document.
- Nuclear energy control systems, combustion systems, railroad systems, aviation systems, medical equipment, amusement machines, vehicles, and installations subject to separate industry or government regulations.
- Systems, machines, and equipment that could present a risk to life or property.

Please know and observe all prohibitions of use applicable to the products.

NEVER USE THE PRODUCTS FOR AN APPLICATION INVOLVING SERIOUS RISK TO LIFE OR PROPERTY WITHOUT ENSURING THAT THE SYSTEM AS A WHOLE HAS BEEN DESIGNED TO ADDRESS THE RISKS, AND THAT THE ABB PRODUCT IS PROPERLY RATED AND INSTALLED FOR THE INTENDED USE WITHIN THE OVERALL EQUIPMENT OR SYSTEM.

Descriptions and examples show how the product works and can be used. It does not mean that it fulfills the requirements for all types of machines and processes. The buyer/user is responsible for installing and using the product according to applicable standards and regulations. We reserve the right to make changes to the product and the documentation without prior notice.

Table of Contents

1	Introduction	4
1.1	Purpose of document	4
1.2	Intended audience	4
1.3	Reading prerequisites.....	4
1.4	Special notes.....	4
2	Safety	5
2.1	Safety precautions	5
3	Product description.....	6
4	Installation.....	7
4.1	Installation precautions	7
4.2	Testing safety functions	7
5	Connections	8
5.1	Connection examples	9
6	Functions	10
6.1	LED Indications	10
6.2	Information output signal attributes.....	10
7	Maintenance	11
7.1	Maintenance precautions	11
8	Troubleshooting	12
8.1	LED indications	12
9	Dimensions.....	13
10	Technical data	14
11	Declaration of conformity	16

1 Introduction

1.1 Purpose of document

The purpose of this document is to describe the functions and to provide instructions for installation, operation, maintenance and troubleshooting of the product.

1.2 Intended audience

This document is intended for authorized personnel.



1.3 Reading prerequisites

It is assumed that the reader of this document has knowledge of the following:

- Basic knowledge of ABB safety products
- Knowledge of machine safety

1.4 Special notes

Pay attention to special notes in the document:





-  **Warning!** Risk of severe personal injury!
An instruction or procedure which, if not carried out correctly, may result in injury to the technician or other personnel.
-  **Caution!** Risk of damage to the equipment!
An instruction or procedure which, if not carried out correctly, may damage the equipment.
-  **Note!** Important or explanatory information.

2 Safety

2.1 Safety precautions

The safety precautions must be followed during installation, operation, maintenance and troubleshooting.

It is the responsibility of the user to ensure the correct overall functionality.

-  **Warning!** Carefully read through the entire product manual before using the device.
-  **Warning!** The devices shall be installed by authorized personnel following applicable Safety regulations, standards and the Machinery directive.
-  **Warning!** Failure to comply with instructions, operation that is not in accordance with the use prescribed in the instructions, improper installation or handling of the device can affect the safety of people and the plant.
-  **Warning!** For installation and prescribed use of the product, the special notes in the instructions must be carefully observed and the technical standards relevant to the application must be considered.
-  **Warning!** In case of failure to comply with the instructions or standards, especially when tampering with and/or modifying the product, any liability is excluded.

3 Product description

Tina 3A and Tina 3Aps are used to adapt safety devices with mechanical contacts to the DYNlink safety circuit monitored by a safety controller or a safety PLC. Examples of such safety devices are emergency stops and switches or light curtains and light beams with internal relay outputs.

Tina 3A is intended for safety devices prepared with a M20 entry. This allows easy installation of the adapter unit within the physical enclosure of the safety device while keeping the status LED visible on the outside of the housing.

Tina 3A/3Aps is equipped with a LED for visual status information of the safety device and the DYNlink safety circuit.

Tina 3A is also equipped with a M12 5-pole connector for easy connection to the DYNlink safety circuit.

Tina 3Aps is identical to Tina 3A but also equipped with two additional connection cables for external power supply.

The Tina 3A/Tina 3Aps adapter unit is intended for use in safety circuits in accordance with EN 60204-1.

4 Installation

- The Tina unit shall be attached to the M20 entry before the safety loops are connected to the device.
- See max. tightening torques in chapter “Technical data”.

4.1 Installation precautions

 **Warning!** To maintain highest safety level and reduce risk of electrical interference the unit shall be installed within the same physical encapsulation as the safety device.

 **Warning!** The safety loop cables (safety loop A and B) shall be as short as possible (max. 300 mm), as longer cables increase the risk for electrical interference.

 **Warning!** All safety functions shall be tested before starting up the system.

4.2 Testing safety functions

After each step the status of the input can be read on the monitoring device.

Steps for testing	LED indication	DYNlink signal output
1. Interrupt the DYNlink safety circuit before the unit to be tested	Green/red flashing	Shall go low
2. Close the DYNlink safety circuit	Green	Shall generate a DYNlink signal
3. Interrupt safety loop A and/or B	Red	Shall go low

5 Connections

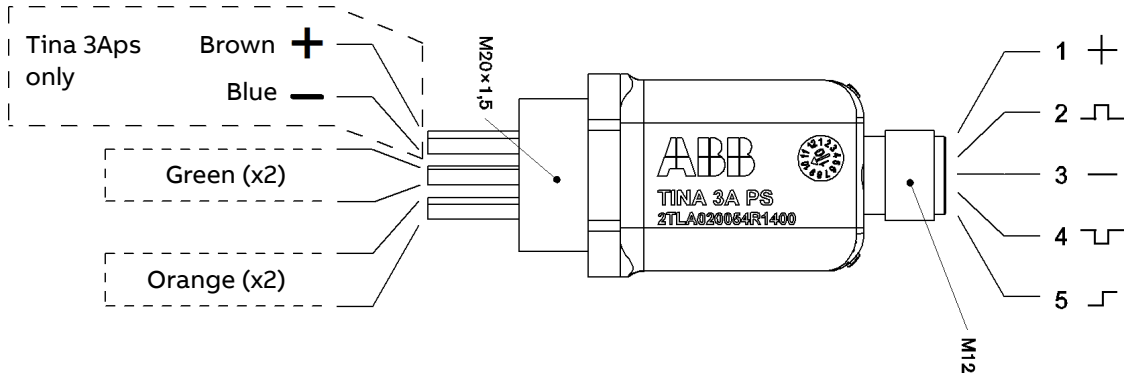

Connection cables to mechanical contacts and power supply (Tina 3Aps only)

Brown	+24 VDC (Tina 3Aps only)
Blue	0 VDC (Tina 3Aps only)
Green	Safety loop A1-A2
Orange	Safety loop B1-B2

M12 5-pole male connector, A-coded to DYNlink safety circuit

1	Brown	+24 VDC
2	White	DYNlink signal input
3	Blue	0 VDC
4	Black	DYNlink signal output
5	Grey	Information output

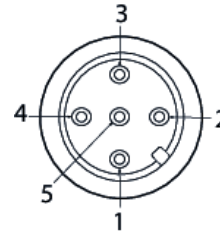

M12 5-pole male connector

- Note!** See connection cable cross section area and cable length in chapter 'Technical data/General'.
- Caution!** All cable colors according to ABB standard cables.
- Warning!** Information output signals shall **never** be used for safety purpose(s).
- Warning!** The connection cables are not monitored and shall therefore be installed within the same physical enclosure as the safety device to maintain the highest safety level (fault exclusion, refer to EN ISO 13849-2:2012, Annex D).
- Warning!** The safety loops shall **not** be used for purposes other than intended. All tampering with safety loops can lead to serious risk to life.

5.1 Connection examples

Tina 3A

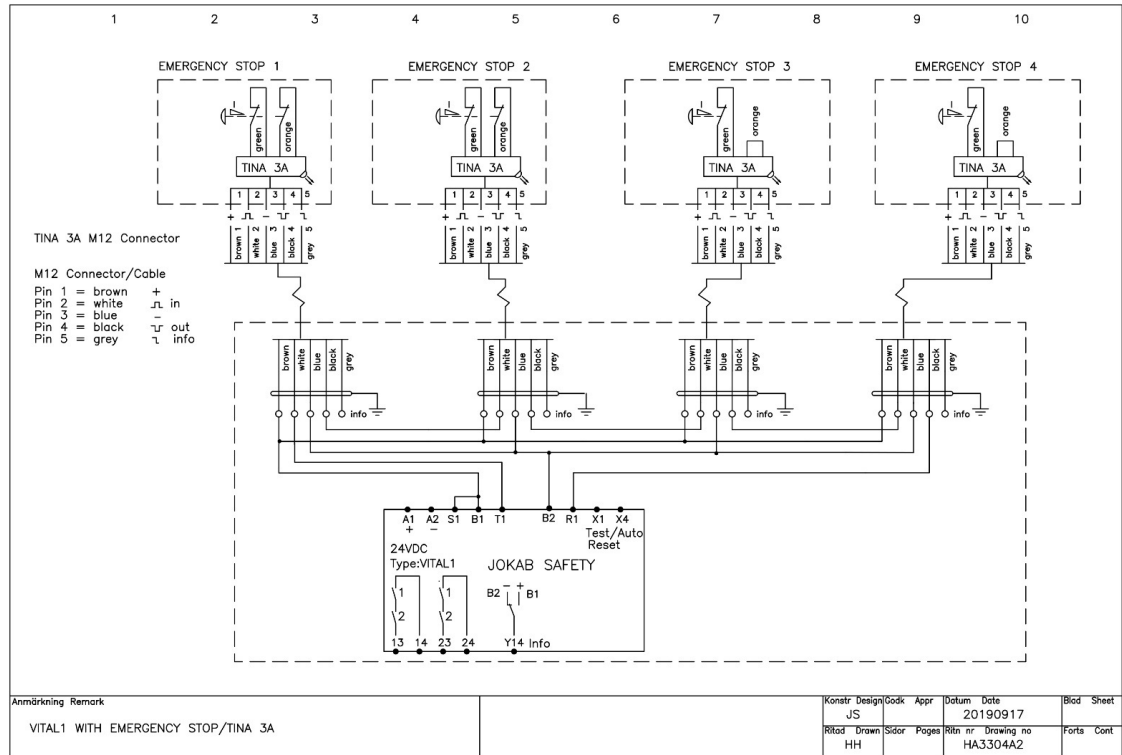

Caution! All cable colors according to ABB standard cables.

Tina 3Aps

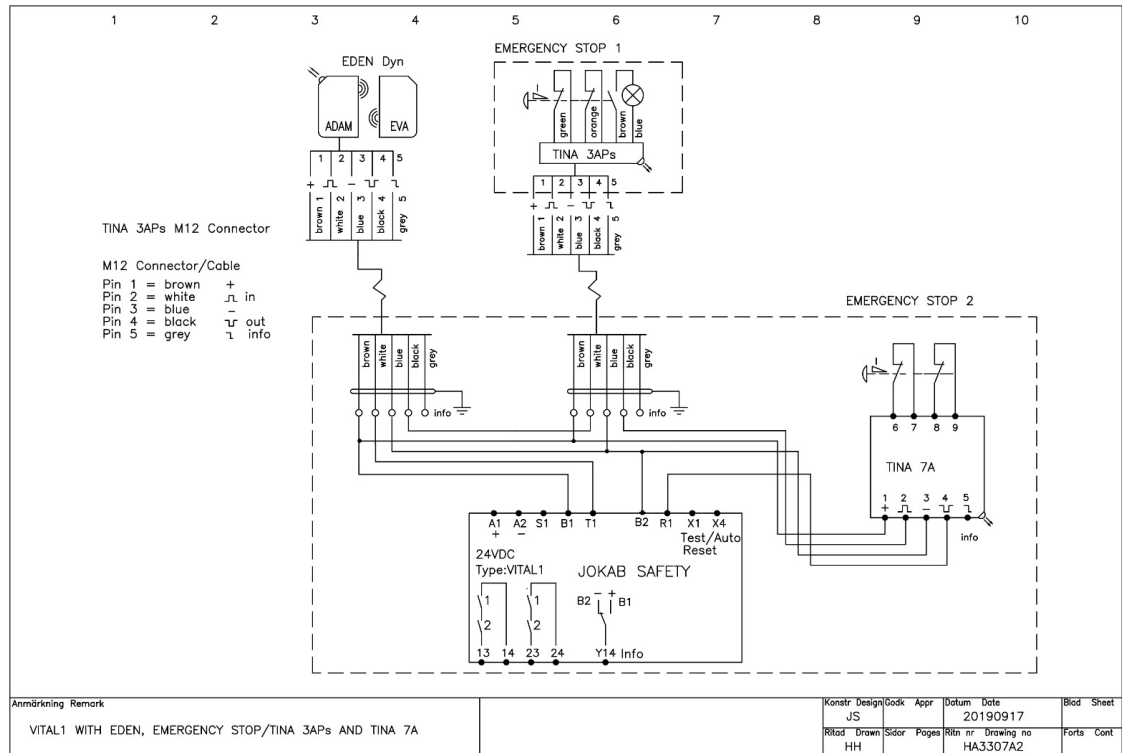

Caution! All cable colors according to ABB standard cables.

6 Functions

6.1 LED Indications

LED indication	Description	DYNlink state
Green	DYNlink input signal, both safety loops closed	OK
Green/red flashing	DYNlink input open or 0 VDC, both safety loops closed	Interrupted before this unit
Red	One or both safety loops open	Interrupted in this unit

6.2 Information output signal attributes

The information output of the unit is set depending on the state of the internal safety loop A/B:

Safety loops (A and B)	Information output
One or both safety loops open	Low
Both safety loops closed	High

The delay for switching the information output signal:

Information output signal switch	High -> Low	Low -> High
Delay	~ 60 ms	~ 10 ms

 **Note!** If any of the safety loops are open longer than 70 ms the information output is set low for approximately 1.2 s. If any of the safety loops stay open the information output stays low. If any of the safety loops are open for less than 50 ms the information output will stay high.

 **Warning!** Information output signals shall never be used for safety purpose(s).

7 Maintenance

Maintenance shall be done in accordance with a risk assessment for the individual application.

7.1 Maintenance precautions

 **Warning!** The safety functions and the mechanics shall be tested regularly, at least once every year to confirm that all the safety functions are working properly (EN 62061:2005+A1:2013+A2:2015, EN ISO 13849-1:2015).

 **Warning!** In case of breakdown or damage to the product, contact ABB. Do not try to repair the product yourself since it may accidentally cause permanent damage to the product, impairing the safety of the device which in turn could lead to serious injury to personnel.

8 Troubleshooting

8.1 LED indications

LED indication	Probable cause	Action
Red	Device pushed/opened	Check status of the device.
	Bad connection between loops (A and/or B) and device terminals	Check terminals and fasten them carefully.
	+24 VDC connected to DYNlink signal input	Check if there is +24 VDC on DYNlink signal input. If yes, check cable connections or the unit before.
No LED light	Loss of power supply	Check +24 VDC / 0 VDC power supply.
Green (but no DYNlink output detected)	Defective DYNlink signal input to unit	Check the DYNlink input or the unit before.
Weak lights	Unit is defective	Replace the unit.

9 Dimensions

All dimensions are in mm.

Tina 3A/Tina 3Aps

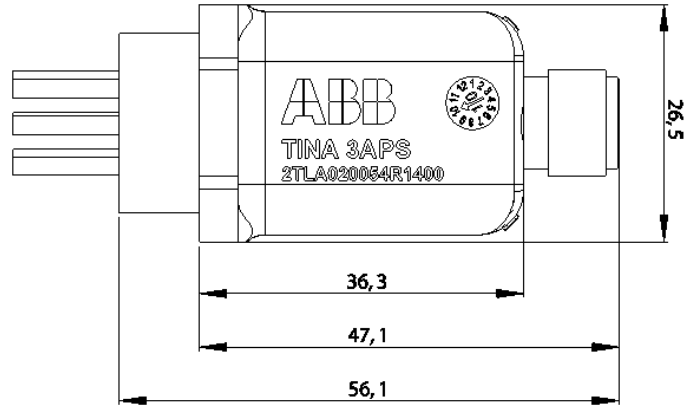
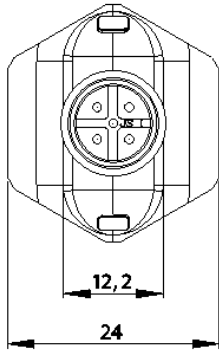

10 Technical data

Further information about the product and accessories is found at:

new.abb.com/low-voltage/products/safety-products

Stated technical data apply when power supply voltage is +24 VDC and ambient temperature is +25 °C, unless stated otherwise.

Manufacturer	
Address	ABB Electrification Sweden AB SE-721 61 Västerås Sweden
Order code/Ordering data	2TLA020054R0200: Tina 3A Adapter 2 contacts M12-5 2TLA020054R1400: Tina 3Aps Adapter 2 contacts + supply M12-5
Power supply	
Required power supply type	PELV/SELV, not intended to be connected to a DC distribution network. Note: A DC distribution network is defined in IEC 61326-3-1:2017 as “Local DC electricity supply network in the infrastructure of a certain site or building intended for connection of any type of equipment”.
Operating voltage	+24 VDC +15 %, -25 %
Total current consumption	Maximum: 35 mA _{RMS}
Note: Total current consumption is the supply current when there is no information output current, no current on Tina 3 Aps power output. Valid over the operating voltage and ambient temperature range.	
DYNlink signal	
DYNlink Input signal voltage	Minimum: 8 V _{RMS} Maximum: 15 V _{RMS}
DYNlink Output signal voltage	Minimum: 8 V _{RMS} Maximum: 15 V _{RMS}
Note: The purpose of stating the voltage in RMS is to facilitate the measurement of the square-wave DYNlink signal with a multimeter.	
Time delay between DYNlink input and output signal (T _{DELAY})	Maximum: 70 μs
Information output	
Output voltage high low	Nominal: Operating voltage - 2 VDC Maximum: 2 VDC
Output current	Maximum: 10 mA
Safety loop output	
Current through safety device contacts	Closed, nominal: 2 mA _{RMS} Wetting, nominal: 12 mA for 700 μs after closing contact
Short circuit current between contacts	Nominal: 12 mA
Loop resistance	Closed, maximum: 500 Ω Open, minimum: 20 kΩ

Power output (Tina 3Aps only)	
Source current	Maximum: 1 A
General	
Protection class	IP67
Ambient temperature	Operation: -10 to +55 °C Storage: -30 to +70 °C
Humidity range	35 to 85 % (with no icing or condensation)
Housing material	TPU
Connectors	M12 5-pole male connector
Cables	Conductor cross section area: 0.34 mm ² (AWG 22) Length: 300 mm Insulation: PVC Conductor material: Tinned stranded copper
Tightening torque	M12 connector: 0.6 Nm M20 nut: 2-2.3 Nm
Size (L x W x H)	56 x 27 x 24 mm
Weight	~ 30 g
Color	Black
Directives / Harmonized standards	
Conformity	European Machinery Directive 2006/42/EC EN ISO 12100:2010 EN 62061:2005+Cor.:2010+A1:2013+A2:2015 EN ISO 13849-1:2015 EN 60204-1:2018
IEC/EN 61508-1...7	SIL3, PFH _D = 4.50·10 ⁻⁹
EN 62061	SIL3
EN ISO 13849-1	PL e, category 4
Certificates	TÜV Nord, cCSAus
Information for use in USA/Canada	
Pollution degree	2
Altitude	2000 m (max)
Humidity	80% max for temperatures up to 31 °C
Indoor use statement	For indoor use only

11 Declaration of conformity

EC Declaration of conformity



EC Declaration of conformity

(according to 2006/42/EC, Annex 2A)

We ABB Electrification Sweden AB
SE-721 61 Västerås
Sweden declare that the safety components of ABB Electrification
Sweden AB make with type designations and safety
functions as listed below, is in conformity with the
Directives
2006/42/EC – Machines
2014/30/EU – EMC
2011/65/EU – RoHS2 + 2015/863

Authorised to compile the technical
file ABB Electrification Sweden AB
SE-721 61 Västerås
Sweden

Product
Adaptor unit
Tina 1-4, Tina 7-8, Tina 11-12

Certificate
44 799 161 35516

Certification body TÜV NORD CERT GmbH
Am TÜV 1
45307 Essen
Germany

Used harmonized standards EN ISO 12100:2010, EN ISO 13849-1:2015,
EN ISO 13849-2:2012, EN 62061:2005+A1:2013+A2:2015,
EN 60204-1:2018, EN 60664-1:2007, EN 61000-6-2:2005,
EN 61000-6-4:2007

Other used standards EN 61508:2010

Viktoria Sakar
R&D team lead Electronics and Software
Västerås 2022-09-27

abb.com/lowvoltage

Original

UK Declaration of conformity



Declaration of conformity

(according to 2008 No 1597)

We ABB Electrification Sweden AB
SE-721 61 Västerås
Sweden declare that the safety components of ABB Electrification Sweden AB make with type designations and safety functions as listed below, is in conformity with UK Statutory Instruments (and their amendments)

2008 No 1597 – Supply of Machinery (Safety) Regulations (MD)
2016 No. 1091 – Electromagnetic Compatibility Regulations (EMC)
2012 No 3032 – Restriction of the Use of Certain Hazardous Substances in Electrical and Electronic Equipment Regulations (RoHS)

Authorized representative ABB Limited
Tower Court
Coventry
CV6 5NX
United Kingdom

Authorised to compile the technical file ABB Limited
Tower Court
Coventry
CV6 5NX
United Kingdom

Product

Adapter unit
Tina 3A
Tina 3Aps

Used designated standards EN ISO 12100:2010, EN ISO 13849-1:2015,
EN 62061:2005+A1:2013+A2:2015, EN 60204-1:2006+A1:2009,
EN 60664-1:2007, EN 61000-6-2:2005, EN 61000-6-4:2007

Other used standards EN 61508:2010

Magnus Backman
R&D Manager
Västerås 2021-04-09

abb.com/lowvoltage

Original