

Power^{IT} Current Limiting Fuses, CEF Power^{IT} Motor Circuits Fuses, CMF

Catalogue 1YMB631051-en



Industrial^{IT}
enabled™



High voltage current limiting fuse links type CEF

Rated voltage: 3,6/7,2-36 kV

Rated current: 6-200 A

Index

1. General.....	3
2. Overvoltages	3
3. Replacement of melted fuse links.....	3
4. Nameplate	3
5. Pre-arcing times	4
6. Current limitation	5
7. Indicator and striker pin	5
8. Choice of fuse links	6
9. Ordering table.....	7
10. Data and dimensions CEF.....	8
11. Accessories	9
12. Data and dimensions CEF-BS.....	10

High voltage current limiting fuse link for MOTOR circuit applications type CMF

Rated voltage:

3,6 kV

7,2 kV

12 kV

Rated current:

100-315 A

63-315 A

63-200 A

Index

1. General	11
2. Nameplate	11
3. Indicator and striker pin	11
4. Ordering table CMF	12
5. Ordering table UCM.....	12
6. Ordering table type CMF-BS	12
7. Pre-arcing times	13
8. Current limitation	13
9. Overvoltages	13
10. Choice of fuse links	14
11. Replacement of melted fuse links.....	15
12. The K-factor	15
13. Data and dimensions CMF	15

High voltage current limiting fuse links type CEF

Rated voltage: 3,6/7,2-36 kV

Rated current: 6-200 A

1. General

The HRC generation of fuse link type CEF are designed and tested according to IEC Publication 282-1. Dimensionally the fuse links are in accordance with DIN 43625.

ABB's high voltage fuse links have the following properties:

- Low minimum breaking current
- Low power losses
- Low arc-voltage
- High breaking capacity
- High current limitation.

Low power losses permit installation of these fuse links in compact switchgear.

CEF fuses are of back-up type. They have a zone between the minimum melting current and the minimum breaking current where the fuse links may fail to interrupt. For CEF fuse links this zone is very narrow. The minimum breaking current I_3 for any type is specified in the table on p. 8.

Other fuse types produced by ABB can be found in the following catalogues:

Fuses for Voltage Transformers WBP/BRT 1YMB6120001-en

Fuses for Railway DC Applications BWT/WBT 1YMB622001-en



2. Overvoltages

In order to be current limiting, the fuse link must generate an arc-voltage exceeding the instantaneous value of the operating voltage. The switching voltage generated by the CEF fuse link is below the maximum permissible value acc. to IEC 282-1. The CEF fuse link can safely be used if the system line voltage is 50-100% of the rated fuse link voltage.

3. Replacement of melted fuse links

Cef fuse links cannot be regenerated. According to IEC Publication 282-1, all 3 fuse links should be replaced, even if only 1 or 2 of the fuse links in the three-phase system have operated. Exceptions are allowed when it can be verified that the fuse link(s) have not experienced any over-current.

4. Nameplate

The symbols on the nameplate have the following meaning:

- I_N = Rated current
- U_N = Rated voltage
- I_3 = Minimum breaking current
- I_1 = Maximum short circuit current for which the fuse is tested

The arrowhead on the nameplate indicates in which end of the fuse link the indicator and striker pin appears. Additionally this end contact of the fuse link is specially marked.

CEF-U is outdoor type.

 STRIKER – SCHLAGSTIFT	ABB	TYPE CEF
	$I_N = 63A$	$I_3 < 3 \times I_N$
	$U_N = 12kV$	$I_1 = 50kA$
	INDOOR – INNENRAUM	
	ABB	

Fuse link type CEF

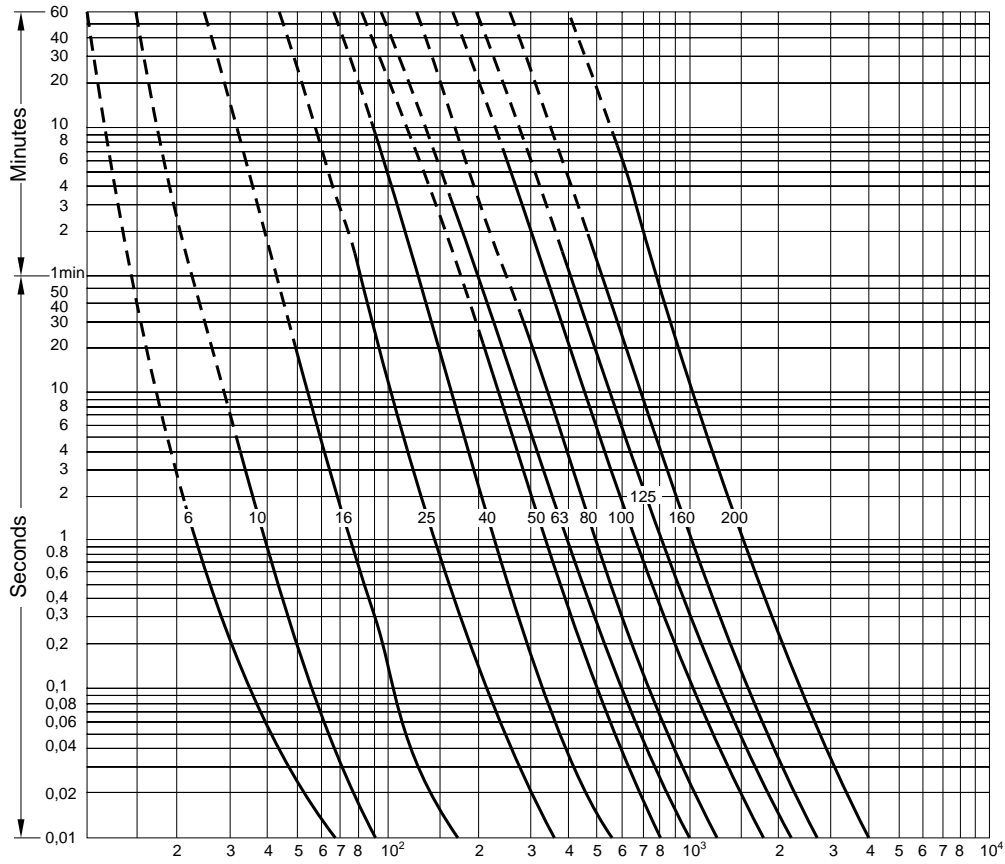

5. Pre-arcing times

The characteristics are equal for all rated voltages and are recorded from cold condition. Dashed sections of the curves indicate the zone of uncertain interruption.

Fuse link type CEF

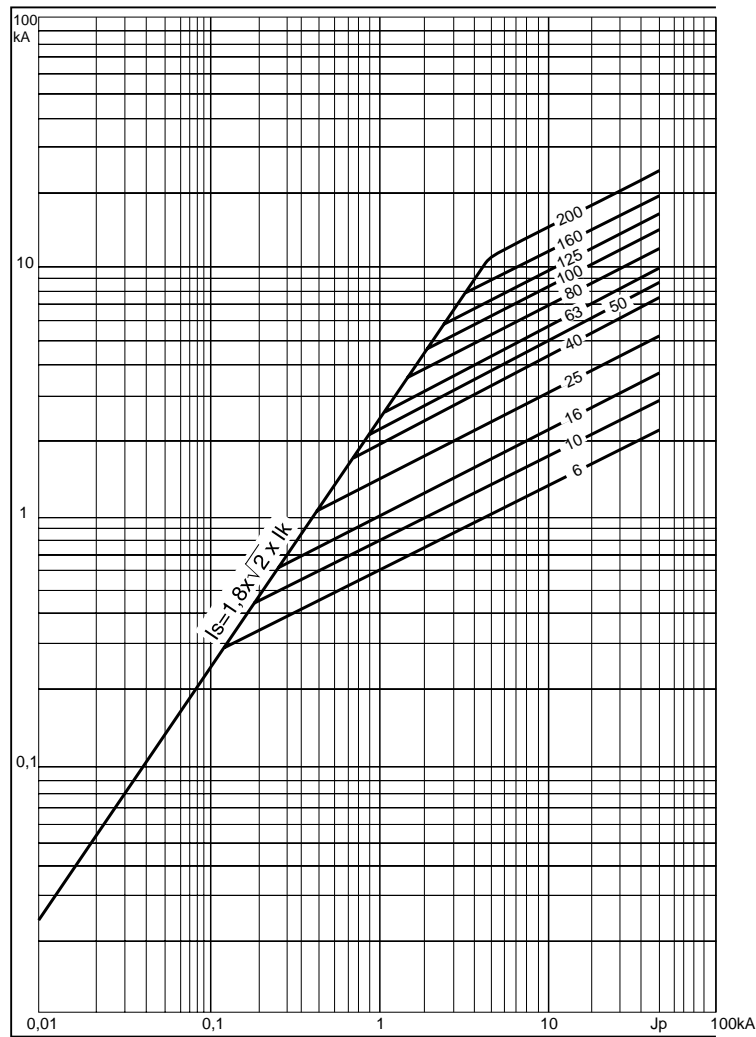

6. Current limitation

CEF fuse links are current limiting. A large short circuit current will therefore not reach its full value. The diagram shows the relation between the prospective short circuit current and the peak value of the cut-off current. Substantial current limitation results in a considerable reduction of the thermal and mechanical stress on the high voltage installation.

7. Indicator and striker pin

The CEF fuse link is equipped with a combined indicator- and striker system, which is activated immediately when the fuse element melts. The force diagram is in accordance with the requirements of IEC 282-1 and DIN 43625.

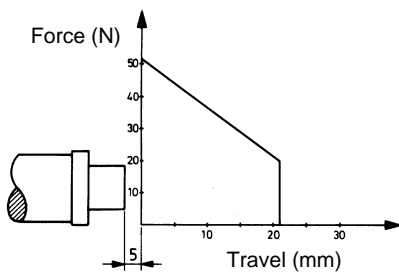

Fuse link type CEF

8. Choice of fuse links

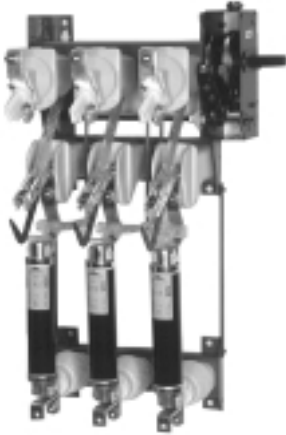

Choice of rated voltage U_N :

The rated voltage of the fuse links must be equal to, or higher than the operating line voltage. By choosing the fuse link rated voltage considerably higher than the line voltage, the maximum arc voltage must not exceed the insulation level of the network.

Choice of rated current I_N :

To obtain the best possible current limitation, and thereby also protection, I_N must be chosen as low as possible compared to the rated current of the object to be protected. However, the following limitations must be taken into consideration:

- the largest load current must not exceed I_N
- cooling conditions (e.g. in compact switchgear).
- inrush current of off load transformers.
- starting currents of motor circuits. (See page 14 with CMF, special motor fuses).

For the choice of rated current of fuse links for protection of transformers, the relation between the power rating of the transformers, operating voltage and rated current of the fuse link is given in the table below. The same table indicates the highest rated current of the low voltage fuse link (on the low voltage side of the transformer) which gives discrimination with the high voltage fuse link. The low voltage fuse link is of the type gL (VDE) or gG / gM (IEC).

For choice of fuse links for transformer protection in switchgear of type Safe Plus or Safering CTC-F, see SF₆ Insulated Compact Switchgear and Ring Main Unit catalogue (NOPOWSR6104GB).

Choice of fuse links for protection of transformers

Line voltage (kV)	TRANSFORMER RATING (kVA)																
	50	75	100	125	160	200	250	315	400	500	630	800	1000	1250	1600	2000	2500
	HIGH VOLTAGE FUSE-LINK I_n (A)																
3	25	25	40	40	63	63	63	80	100	100	160	200	200	250*	315*		
5	16	25	25	25	40	40	63	63	63	80	100	100	160	200	200	250*	315*
6	16	16	25	25	25	40	40	63	63	63	80	100	100	160	200	200	250*
10	10	16	16	16	25	25	25	40	40	63	63	63	80	100	100	160	200
12	10	16	16	16	16	25	25	25	40	40	63	63	63	80	100	160	160
15	10	10	16	16	16	16	25	25	25	40	40	63	63	63	100	100	125
20	10	10	10	16	16	16	16	25	25	25	40	40	63	63	63	80	100
24	10	10	10	10	16	16	16	16	25	25	25	40	40	63	63	63	80
30	10	10	10	10	10	16	16	16	16	25	25	25	40	40	40	2x40	2x40
36	10	10	10	10	10	10	16	16	16	16	25	25	25	40	40	2x40	2x40
	LOW VOLTAGE FUSE-LINK I_n (A)																
220 V	80	100	125	160	200	250	250	315	400	500	630						
380 V	50	63	100	100	125	125	200	250	250	350	400	400	500	630			
500 V	40	50	80	80	100	100	160	160	200	250	350	350	400	500	630		

* CMF - fuse link

Fuse link type CEF

9. Ordering table

High-voltage – HRC fuse links

Type	Rated voltage kV	Rated current A	e/D mm	Old No.	New No.	Weight kg	e/D mm	Old No.	New No.	Weight kg
CEF	3.6/7,2	6	192/65	NHPL052711R1	1YMB531001M0001	1,5	292/65		1YMB531034M0001	2,3
CEF	3.6/7,2	10	192/65	NHPL052713R1	1YMB531001M0002	1,5	292/65		1YMB531034M0002	2,3
CEF	3.6/7,2	16	192/65	NHPL052714R1	1YMB531001M0003	1,5	292/65		1YMB531034M0003	2,3
CEF	3.6/7,2	25	192/65	NHPL052715R1	1YMB531001M0004	1,5	292/65		1YMB531034M0004	2,3
CEF	3.6/7,2	40	192/65	NHPL052716R1	1YMB531001M0005	1,5	292/65		1YMB531034M0005	2,3
CEF	3.6/7,2	50	192/65	NHP 241035R12	1YMB531001M0006	1,5	292/65		1YMB531034M0006	2,3
CEF	3.6/7,2	63	192/65	NHPL052717R1	1YMB531001M0007	1,5	292/65		1YMB531034M0007	2,3
CEF	3.6/7,2	80	192/65	NHPL052701R1	1YMB531001M0008	2,6	292/87		1YMB531034M0008	3,6
CEF	3.6/7,2	100	192/65	NHPL052718R1	1YMB531001M0009	2,6	292/87		1YMB531034M0009	3,6
CEF	3.6/7,2	125					292/87	NHPL052702R1	1YMB531001M0010	3,6
CEF	3.6/7,2	160					292/87	NHPL052719R1	1YMB531001M0011	3,6
CEF	3.6/7,2	200					292/87	NHPL052720R1	1YMB531001M0012	3,6
CEF	12	6	292/65	NHPL052721R1	1YMB531002M0001	2,3	442/65		1YMB531035M0001	3
CEF	12	10	292/65	NHPL052723R1	1YMB531002M0002	2,3	442/65		1YMB531035M0002	3
CEF	12	16	292/65	NHPL052724R1	1YMB531002M0003	2,3	442/65		1YMB531035M0003	3
CEF	12	25	292/65	NHPL052725R1	1YMB531002M0004	2,3	442/65		1YMB531035M0004	3
CEF	12	40	292/65	NHPL052726R1	1YMB531002M0005	2,3	442/65		1YMB531035M0005	3
CEF	12	50	292/65	NHP 241036R12	1YMB531002M0006	2,3	442/65		1YMB531035M0006	3
CEF	12	63	292/65	NHPL052727R1	1YMB531002M0007	2,3	442/65		1YMB531035M0007	3
CEF	12	80	292/87	NHPL052703R1	1YMB531002M0008	3,8	442/87		1YMB531035M0008	5,2
CEF	12	100	292/87	NHPL052728R1	1YMB531002M0009	3,8	442/87		1YMB531035M0009	5,2
CEF	12	125					442/87	NHPL052704R1	1YMB531002M0010	5,2
CEF	12	160					442/87	NHPL052729R1	1YMB531002M0011	5,2
CEF	12	200					442/87	NHPL052730R1	1YMB531002M0012	5,2
CEF	17,5	6	292/65	NHPL052731R1	1YMB531003M0001	2,3	367/65		1YMB531036M0001	2,7
CEF	17,5	10	292/65	NHPL052733R1	1YMB531003M0002	2,3	367/65		1YMB531036M0002	2,7
CEF	17,5	16	292/65	NHPL052734R1	1YMB531003M0003	2,3	367/65		1YMB531036M0003	2,7
CEF	17,5	25	292/65	NHPL052735R1	1YMB531003M0004	2,3	367/65		1YMB531036M0004	2,7
CEF	17,5	40	292/87	NHPL052736R1	1YMB531003M0005	3,8	367/87		1YMB531036M0005	4,4
CEF	17,5	50	292/87	NHP 241037R11	1YMB531003M0006	3,8	367/87		1YMB531036M0006	4,4
CEF	17,5	63	292/87	NHPL052737R1	1YMB531003M0007	3,8	367/87		1YMB531036M0007	4,4
CEF	17,5	6	442/65		1YMB531037M0001	3				
CEF	17,5	10	442/65		1YMB531037M0002	3				
CEF	17,5	16	442/65		1YMB531037M0003	3				
CEF	17,5	25	442/65		1YMB531037M0004	3				
CEF	17,5	40	442/87		1YMB531037M0005	5,3				
CEF	17,5	50	442/87		1YMB531037M0006	5,3				
CEF	17,5	63	442/87		1YMB531037M0007	5,3				
CEF	17,5	80	442/87	NHPL052705R1	1YMB531003M0008	5,3				
CEF	17,5	100	442/87	NHPL052738R1	1YMB531003M0009	5,3				
CEF	17,5	125	442/87	NHPL052739R1	1YMB531003M0010	5,3				
CEF	24	6	442/65	NHPL052741R1	1YMB531004M0001	3				
CEF	24	10	442/65	NHPL052743R1	1YMB531004M0002	3				
CEF	24	16	442/65	NHPL052744R1	1YMB531004M0003	3				
CEF	24	25	442/65	NHPL052745R1	1YMB531004M0004	3				
CEF	24	40	442/65	NHPL052746R1	1YMB531004M0005	3				
CEF	24	50	442/87	NHP 241038R6	1YMB531004M0006	5,3				
CEF	24	63	442/87	NHPL052747R1	1YMB531004M0007	5,3				
CEF	24	80	442/87	NHP 200473R2	1YMB531022M0001	5,3	537/87	NHPL052706R1	1YMB531004M0008	6,2
CEF	24	100	442/87	NHP 200473R1	1YMB531022M0002	5,3	537/87	NHPL052748R1	1YMB531004M0009	6,2
CEF	24	125	442/87	NHP 200473R3	1YMB531022M0003	5,3	537/87	NHPL052749R1	1YMB531004M0010	6,2
CEF	27	6	442/65	NHP 241410R7	1YMB531005M0001	3				
CEF	27	10	442/65	NHP 241410R8	1YMB531005M0002	3				
CEF	27	16	442/65	NHP 241410R9	1YMB531005M0003	3				
CEF	27	25	442/87	NHP 241410R1	1YMB531005M0004	3				
CEF	27	40	442/87	NHP 241410R2	1YMB531005M0005	3				
CEF	27	50	442/87	NHP 241410R5	1YMB531005M0006	5,3				
CEF	27	63	442/87	NHP 241410R3	1YMB531005M0007	5,3				
CEF	27	80	537/87	NHP 241410R10	1YMB531005M0008	6,2				
CEF	27	100	537/87	NHP 241410R4	1YMB531005M0009	6,2				
CEF	36	6	537/65	NHPL052750R1	1YMB531006M0001	3,1				
CEF	36	10	537/65	NHPL052752R1	1YMB531006M0002	3,1				
CEF	36	16	537/65	NHPL052753R1	1YMB531006M0003	3,1				
CEF	36	25	537/87	NHPL052754R1	1YMB531006M0004	6,2				
CEF	36	40	537/87	NHPL052755R1	1YMB531006M0005	6,2				

Other ratings and dimensions on request.

When ordering outdoor version pls. indicate CEF-U.

Fuse link type CEF

10. Data and dimensions CEF

U_N	I_N	e	D	I_1	I_3	P_N	R_0	
kV	A	mm	mm	kA	A	W	mΩ	
3,6/7,2	6	192/292	65	50	35	26	489	
	10	192/292	65	50	55	16	120	
	16	192/292	65	50	55	26	60,2	
	25	192/292	65	50	72	24	30,1	
	40	192/292	65	50	100	30	15,3	
	50	192/292	65	50	190	35	10,4	
	63	192/292	65	50	190	40	7,8	
	80	192/292	87	50	250	52	6,2	
	100	192/292	87	50	275	57	4,4	
	125	292	87	50	375	76	3,5	
	160	292	87	50	480	101	2,6	
200	292	87	50	650	107	1,7		
12	6	292/442	65	50	35	41	735	
	10	292/442	65	50	55	33	180	
	16	292/442	65	50	55	32	105	
	25	292/442	65	50	77	47	52,6	
	40	292/442	65	50	105	52	23,0	
	50	292/442	65	50	190	70	17,9	
	63	292/442	65	50	190	78	13,4	
	80	292/442	87	50	250	82	9,2	
	100	292/442	87	50	275	103	6,6	
	125	442	87	50	375	125	5,3	
	160	442	87	50	480	170	3,9	
200	442	87	50	650	174	2,7		
17,5	6	292/367/442	65	20	35	54	880	
	10	292/367/442	65	20	55	41	271	
	16	292/367/442	65	20	55	67	135	
	25	292/367/442	65	25	72	64	67,7	
	40	292/367/442	87	25	100	80	34,5	
	50	292/367/442	87	25	210	90	23,1	
	63	292/367/442	87	25	210	100	17,3	
	80	442	87	25	250	124	13,8	
	100	442	87	25	275	136	9,9	
	125	442	87	25	375	175	7,9	
	24	6	442	65	25	35	91	1370
10		442	65	25	55	62	361	
16		442	65	25	55	72	181	
25		442	65	25	72	79	90,2	
40		442	65	25	110	106	46,0	
50		442	87	25	210	130	30,7	
63		442	87	25	210	147	23,0	
80		537	87	25	250	165	18,4	
100		537	87	25	300	186	13,2	
125		537	87	25	375	234	10,5	
27		6	442	65	20	35	91	1340
	10	442	65	20	55	80	451,2	
	16	442	65	20	55	90	225,6	
	25	442	87	20	72	100	112,8	
	40	442	87	20	110	130	55,6	
	50	442	87	20	210	130	30,7	
	63	442	87	20	210	147	23,0	
	80	537	87	20	250	210	23,0	
	100	537	87	20	300	235	15,8	
	36	6	537	65	20	35	137	2055
		10	537	65	20	55	93	572
16		537	65	20	55	109	286	
25		537	87	20	72	144	143	
40		537	87	20	100	176	69,1	

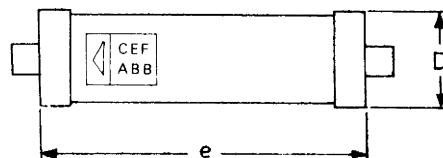

I_1 = maximum short-circuit current tested
 I_3 = minimum breaking current
 P_N = power loss at rated current
 R_0 = resistance at room temp.

Fuse link type CEF

11. Accessories

Fuse base type UCE

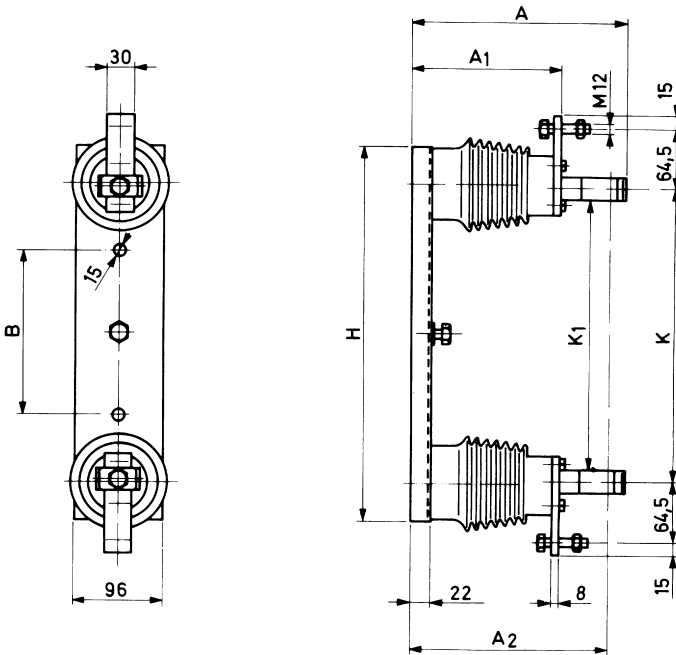

Fuse clips

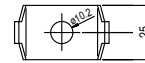
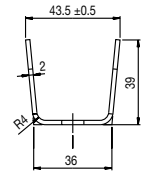

Old No. NHP400728P1
New No. 1YMX400728P0001

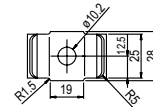
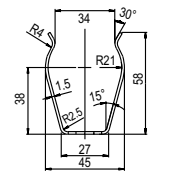

Old No. NHP400727P1
New No. 1YMX400727P0001

Ordering table

Type	Rated voltage	Current ratings	Fuse length	Dimensions in mm							Weight	Old No.	New No.
	kV			A	mm	A	A ₁	A ₂	H	K			
UCE 7,2	3,6/7,2	6-100	192	232	160	220	310	218	193	55	3,4	NHPL52501R1	1YMX052501M001
UCE 12	3,6/7,2 12	125-200	292	232	160	220	410	318	293	180	3,7	NHPL52503R1	1YMX052503M001
		6-100										NHPL52503R1	1YMX052503M001
UCE 12 L	12	125-200	442	232	160	220	570	468	443	300	4,2	NHPL52505R1	1YMX052505M001
UCE 17,5	17,5	6-63	292	327	255	315	410	318	293	180	3,7	HNPL52507R1	1YMX052507M001
UCE 24	17,5 24	80-125	442	327	255	315	570	468	443	300	6,9	NHPL52509R1	1YMX052509M001
		6-63										NHPL52509R1	1YMX052509M001
UCE 24 L	24	80-125	537	327	255	315	675	563	538	380	7,4	NHPL52511R1	1YMX052511M001
UCE 36	36	6-40	537	412	340	400	675	563	538	380	7,6	NHPL52513R1	1YMX052513M001

CEF test fuse-link 3,6/7,2-36 kV for test of striker system.

Old No.	New No.	Weight kg	Dimension in mm	
			e*	Total length
NHP 300062	1YMX300062R001	1,4	192	605
			292	
			442	
			537	

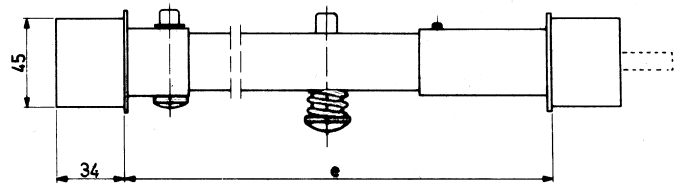

* Adjustable.

The striker has a force-travel characteristic as shown in the figure on page 5.

Operating tong for fuse links CEF 3,6/7,2 – 36 KV

Old No.	New No.	Test voltage kV	Weight kg
NHPL053006R1	1YMX053006M001	100	2,2

Dimensions in mm		
L1	L2	A3(Ø)
700	600	30-90

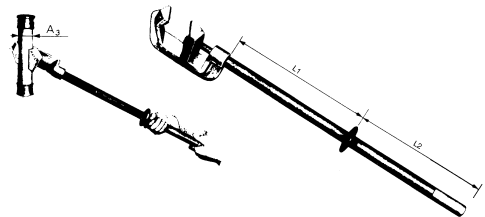

Fuse link type CEF

12. Data and dimensions CEF-BS

Data and dimensions CEF-BS acc. to EN 60282-1:1996

Type	Rated voltage kV	Rated current A	L/D mm	A mm	Old No.	New No.
CEF-BS	3.6/7,2	6	307/65	342	NHP 200380R1	1YMB531007M0001
CEF-BS	3.6/7,2	10	307/65	342	NHP 200380R2	1YMB531007M0002
CEF-BS	3.6/7,2	16	307/65	342	NHP 200380R3	1YMB531007M0003
CEF-BS	3.6/7,2	25	307/65	342	NHP 200380R4	1YMB531007M0004
CEF-BS	3.6/7,2	40	307/65	342	NHP 200380R5	1YMB531007M0005
CEF-BS	3.6/7,2	50	307/65	342	NHP 200380R6	1YMB531007M0006
CEF-BS	3.6/7,2	63	307/65	342	NHP 200380R7	1YMB531007M0007
CEF-BS	3.6/7,2	80	307/65	342	NHP 200380R8	1YMB531007M0008
CEF-BS	3.6/7,2	100	307/65	342	NHP 200380R9	1YMB531007M0009
CEF-BS	3.6/7,2	125	407/87	442	NHP 200380R10	1YMB531007M0010
CEF-BS	3.6/7,2	160	407/87	442	NHP 200380R11	1YMB531007M0011
CEF-BS	3.6/7,2	200	407/87	442	NHP 200380R12	1YMB531007M0012
CEF-BS	12	6	407/65	442	NHP 200381R1	1YMB531008M0001
CEF-BS	12	10	407/65	442	NHP 200381R2	1YMB531008M0002
CEF-BS	12	16	407/65	442	NHP 200381R3	1YMB531008M0003
CEF-BS	12	25	407/65	442	NHP 200381R4	1YMB531008M0004
CEF-BS	12	40	407/65	442	NHP 200381R5	1YMB531008M0005
CEF-BS	12	50	407/65	442	NHP 200381R6	1YMB531008M0006
CEF-BS	12	63	407/65	442	NHP 200381R7	1YMB531008M0007
CEF-BS	12	80	407/65	442	NHP 200381R8	1YMB531008M0008
CEF-BS	12	100	407/65	442	NHP 200381R9	1YMB531008M0009
CEF-BS	12	125	557/87	592	NHP 200381R10	1YMB531008M0010
CEF-BS	12	160	557/87	592	NHP 200381R11	1YMB531008M0011
CEF-BS	12	200	557/87	592	NHP 200381R12	1YMB531008M0012
CEF-BS	17,5	6	407/65	442	NHP 200382R1	1YMB531009M0001
CEF-BS	17,5	10	407/65	442	NHP 200382R2	1YMB531009M0002
CEF-BS	17,5	16	407/65	442	NHP 200382R3	1YMB531009M0003
CEF-BS	17,5	25	407/65	442	NHP 200382R4	1YMB531009M0004
CEF-BS	17,5	40	407/65	442	NHP 200382R5	1YMB531009M0005
CEF-BS	17,5	50	407/65	442	NHP 200382R6	1YMB531009M0006
CEF-BS	17,5	63	407/65	442	NHP 200382R7	1YMB531009M0007
CEF-BS	17,5	80	557/87	592	NHP 200382R8	1YMB531009M0008
CEF-BS	17,5	100	557/87	592	NHP 200382R9	1YMB531009M0009
CEF-BS	17,5	125	557/87	592	NHP 200382R10	1YMB531009M0010
CEF-BS	24	6	557/65	592	NHP 200383R1	1YMB531010M0001
CEF-BS	24	10	557/65	592	NHP 200383R2	1YMB531010M0002
CEF-BS	24	16	557/65	592	NHP 200383R3	1YMB531010M0003
CEF-BS	24	25	557/65	592	NHP 200383R4	1YMB531010M0004
CEF-BS	24	40	557/65	592	NHP 200383R5	1YMB531010M0005
CEF-BS	24	50	557/65	592	NHP 200383R7	1YMB531010M0006
CEF-BS	24	63	557/65	592	NHP 200383R6	1YMB531010M0007

Type	Rated voltage kV	Rated current A	L/D mm	A mm	Old No.	New No.
CEF-BS	3.6/7,2	6	305/65	347	NHP200380R21	1YMB531007M0021
CEF-BS	3.6/7,2	10	307/65	347	NHP200380R22	1YMB531007M0022
CEF-BS	3.6/7,2	16	307/65	347	NHP200380R23	1YMB531007M0023
CEF-BS	3.6/7,2	25	307/65	347	NHP200380R24	1YMB531007M0024
CEF-BS	3.6/7,2	40	307/65	347	NHP200380R25	1YMB531007M0025
CEF-BS	3.6/7,2	50	307/65	347	NHP200380R26	1YMB531007M0026
CEF-BS	3.6/7,2	63	307/65	347	NHP200380R27	1YMB531007M0027
CEF-BS	3.6/7,2	80	307/65	347	NHP200380R28	1YMB531007M0028
CEF-BS	3.6/7,2	100	307/65	347	NHP200380R29	1YMB531007M0029
CEF-BS	3.6/7,2	125	419/87	464	NHP200380R30	1YMB531007M0030
CEF-BS	3.6/7,2	160	407/87	464	NHP200380R31	1YMB531007M0031
CEF-BS	3.6/7,2	200	407/87	464	NHP200380R32	1YMB531007M0032
CEF-BS	12	6	407/65	464	NHP200381R21	1YMB531008M0021
CEF-BS	12	10	407/65	464	NHP200381R22	1YMB531008M0022
CEF-BS	12	16	407/65	464	NHP200381R23	1YMB531008M0023
CEF-BS	12	25	407/65	464	NHP200381R24	1YMB531008M0024
CEF-BS	12	40	407/65	464	NHP200381R25	1YMB531008M0025
CEF-BS	12	50	407/65	464	NHP200381R26	1YMB531008M0026
CEF-BS	12	63	407/65	464	NHP200381R27	1YMB531008M0027
CEF-BS	12	80	407/65	464	NHP200381R28	1YMB531008M0028
CEF-BS	12	100	407/65	464	NHP200381R29	1YMB531008M0029
CEF-BS	12	125	553/87	595	NHP200381R30	1YMB531008M0030
CEF-BS	12	160	557/87	595	NHP200381R31	1YMB531008M0031
CEF-BS	12	200	557/87	595	NHP200381R32	1YMB531008M0032
CEF-BS	17,5	6	419/65	464	NHP200382R21	1YMB531009M0021
CEF-BS	17,5	10	407/65	464	NHP200382R22	1YMB531009M0022
CEF-BS	17,5	16	407/65	464	NHP200382R23	1YMB531009M0023
CEF-BS	17,5	25	407/65	464	NHP200382R24	1YMB531009M0024
CEF-BS	17,5	40	407/65	464	NHP200382R25	1YMB531009M0025
CEF-BS	17,5	50	407/65	464	NHP200382R26	1YMB531009M0026
CEF-BS	17,5	63	407/65	464	NHP200382R27	1YMB531009M0027
CEF-BS	17,5	80	553/87	595	NHP200382R28	1YMB531009M0028
CEF-BS	17,5	100	557/87	595	NHP200382R29	1YMB531009M0029
CEF-BS	17,5	125	557/87	595	NHP200382R30	1YMB531009M0030
CEF-BS	24	6	557/65	595	NHP200383R21	1YMB531010M0021
CEF-BS	24	10	557/65	595	NHP200383R22	1YMB531010M0022
CEF-BS	24	16	557/65	595	NHP200383R23	1YMB531010M0023
CEF-BS	24	25	557/65	595	NHP200383R24	1YMB531010M0024
CEF-BS	24	40	557/65	595	NHP200383R25	1YMB531010M0025
CEF-BS	24	50	557/65	595	NHP200383R26	1YMB531010M0026
CEF-BS	24	63	557/65	595	NHP200383R27	1YMB531010M0027

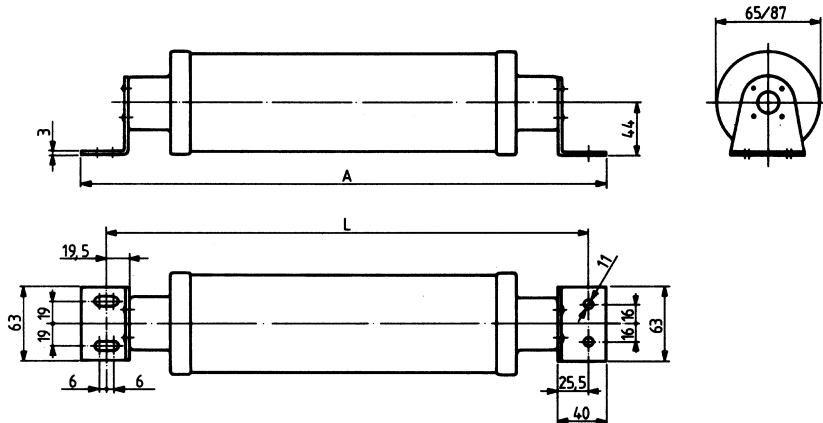

High voltage current limiting fuse link for MOTOR circuit applications type CMF

Rated voltage:
3,6 kV
7,2 kV
12 kV

Rated current:
100-315 A
63-315 A
63-200 A

1. General



The fuse links type CMF are specially designed for motor circuit applications. They are tested according to the IEC Publication 282-1 and Publication 644. The IEC 644 applies to fuse links used with motors started direct-on-line on alternating current systems. High voltage fuses used in motor circuits must have the ability to withstand, without deterioration, the repeated surges associated with motor starting.

The dimensions are in accordance with DIN 43625, i.e. the 3,6 kV rating is realized in the normal 12 kV length ($e = 292$ mm). The 7,2 kV and 12 kV rating in the 24 kV length ($e = 442$ mm). Special connection elements can be delivered in cases where fuses have to be paralleled.

ABB's motor fuses have the following properties:

- higher current rating within single body dimensions
- tested according to IEC 644 which guaranties excellent ability to withstand repeated motor starting conditions
- low power losses
- low minimum-breaking-current
- high breaking capacity and excellent short circuit current limitation.

Although a motor fuse is normally run at a stationary current which is much lower than the fuse rated current, the low-loss characteristics of the CMF fuses make them especially suitable in compact contactor compartments.

2. Nameplate

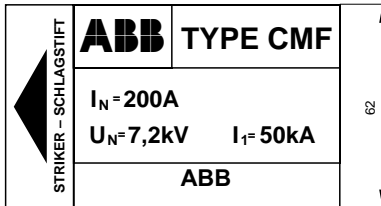

The symbols on the nameplate have the following meaning:

- I_N = Rated current
- U_N = Rated voltage
- I_1 = Maximum short circuit current for which the fuse is tested

The arrowhead on the nameplate indicates in which end of the fuse link the indicator and striker pins appears. Additionally this end contact of the fuse links is specially marked.

3. Indicator and striker pin

The CMF fuse links are equipped with a combined indicator and striker system, which is activated immediately when the fuse element melts. The force diagram is in accordance with the requirements of IEC 282-1 and DIN 43625.

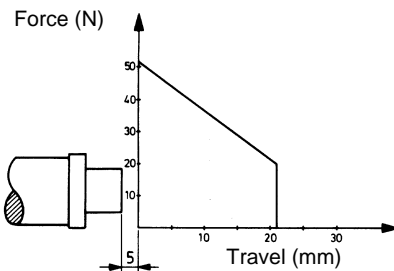

Fuse link type CMF

4. Ordering table type CMF

High voltage – fuse links



Type	Rated voltage kV	Rated current A	e	Old No.	New No.	Weight kg
CMF	3,6	100	292	NHPL052760R1	1YMB531028M0001	2.3
CMF	3,6	160	292	NHPL052761R1	1YMB531028M0002	2.3
CMF	3,6	200	292	NHPL052762R1	1YMB531028M0003	2.3
CMF	3,6	250	292	NHPL052763R1	1YMB531028M0004	3.8
CMF	3,6	315	292	NHPL052764R1	1YMB531028M0005	3.8
CMF	7,2	63	442	NHPL052770R1	1YMB531029M0001	3.0
CMF	7,2	100	442	NHPL052771R1	1YMB531029M0002	3.0
CMF	7,2	160	442	NHPL052772R1	1YMB531029M0003	3.0
CMF	7,2	200	442	NHPL052773R1	1YMB531029M0004	5.3
CMF	7,2	250	442	NHPL052774R1	1YMB531029M0005	5.3
CMF	7,2	315	442	NHPL052775R1	1YMB531029M0006	5.3
CMF	12	63	442	NHPL052776R1	1YMB531030M0001	3.0
CMF	12	100	442	NHPL052777R1	1YMB531030M0002	5.3
CMF	12	160	442	NHPL052778R1	1YMB531030M0003	5.3
CMF	12	200	442	NHPL052779R1	1YMB531030M0004	5.3

FUSE BASE TYPE UCM

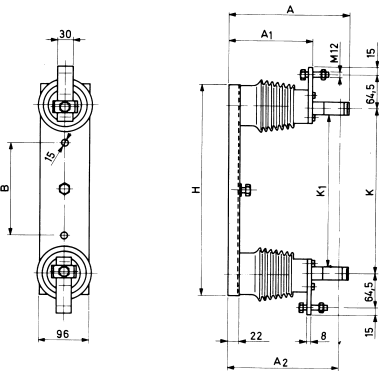

5. Ordering table UCM

Type	Rated voltage kV	Dimensions in mm							Weight kg	Old No.	New No.
		A	A ₁	A ₂	H	K	K ₁	B			
UCM	3,6	232	160	220	410	318	293	180	3,7	NHP139037R1	1YMX139037R001
UCM	7,2/12	232	160	220	570	468	443	300	4,2	NHP139037R2	1YMX139037R002

Dimension CMF-BS

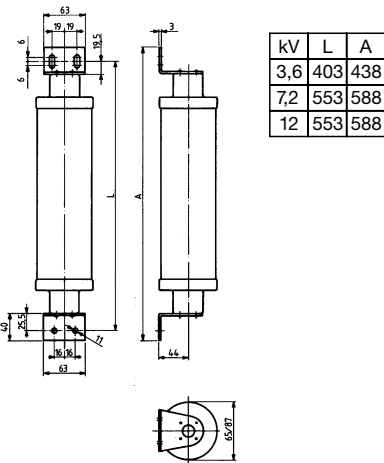

6. Ordering table type CMF-BS

Type	Rated voltage kV	Rated current A	e	Old No.	New No.	Weight kg
CMF-BS	3,6	100	292	NHPL241347R1	1YMB531031M0001	2.3
CMF-BS	3,6	160	292	NHPL241347R2	1YMB531031M0002	2.3
CMF-BS	3,6	200	292	NHPL241347R3	1YMB531031M0003	2.3
CMF-BS	3,6	250	292	NHPL241347R4	1YMB531031M0004	3.8
CMF-BS	3,6	315	292	NHPL241347R5	1YMB531031M0005	3.8
CMF-BS	7,2	63	442	NHPL241347R6	1YMB531032M0001	3.0
CMF-BS	7,2	100	442	NHPL241347R7	1YMB531032M0002	3.0
CMF-BS	7,2	160	442	NHPL241347R8	1YMB531032M0003	3.0
CMF-BS	7,2	200	442	NHPL241347R9	1YMB531032M0004	5.3
CMF-BS	7,2	250	442	NHPL241347R10	1YMB531032M0005	5.3
CMF-BS	7,2	315	442	NHPL241347R11	1YMB531032M0006	5.3
CMF-BS	12	63	442	NHPL241347R13	1YMB531033M0001	3.0
CMF-BS	12	100	442	NHPL241347R14	1YMB531033M0002	5.3
CMF-BS	12	160	442	NHPL241347R15	1YMB531033M0003	5.3
CMF-BS	12	200	442	NHPL241347R16	1YMB531033M0004	5.3

Fuse link type CMF

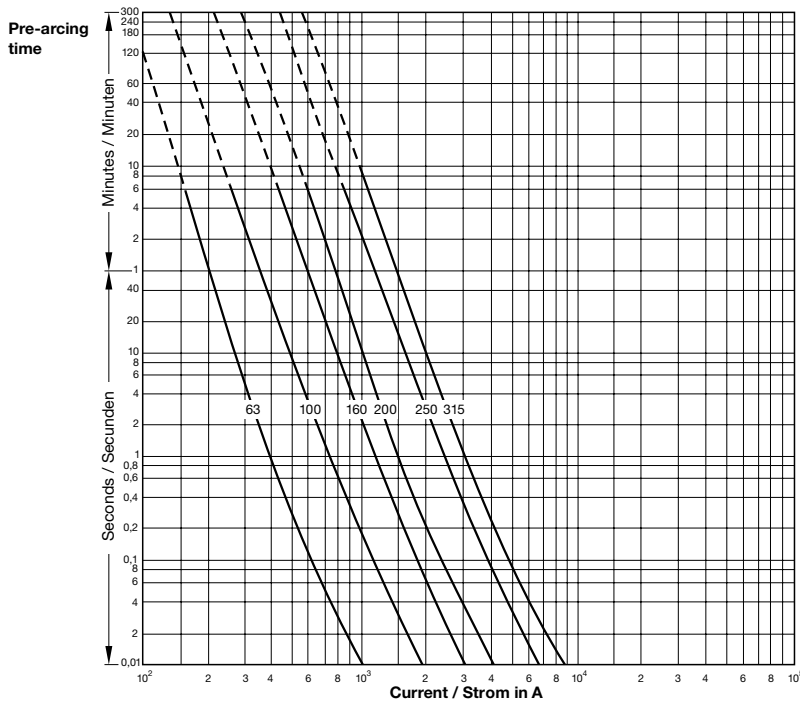

7. Pre-arcing times

The characteristics are equal for all rated voltages and are recorded from cold condition. Dashed sections of the curves indicate the zone of uncertain interruption.

Maximum cut of current kA (peak)

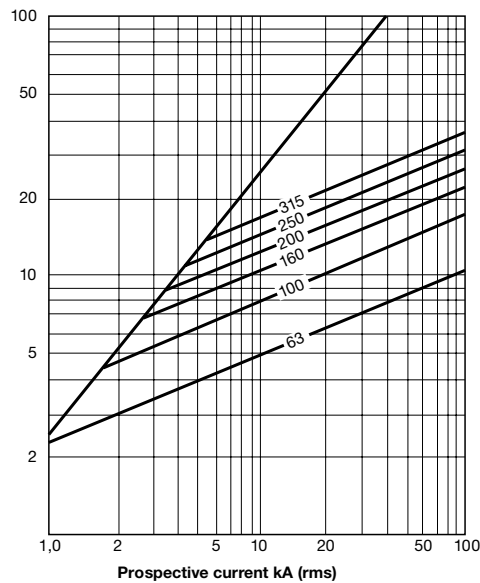

8. Current limitation

CMF fuse links are current limiting. A large short circuit current will therefore not reach its full value. The diagram shows the relation between the prospective short circuit current and the peak value of the cut off current.

9. Overvoltages

In order to be current limiting, the fuse links must generate an arc voltage exceeding the instantaneous value of the operating voltage. The overvoltage generated by the CMF fuse link is below the maximum permissible value acc to IEC 282-1. CMF fuse links can safely be used if the system line voltage is 50-100% of the rated fuse link voltage.

Fuse link type CMF

Fuselink rating [A]

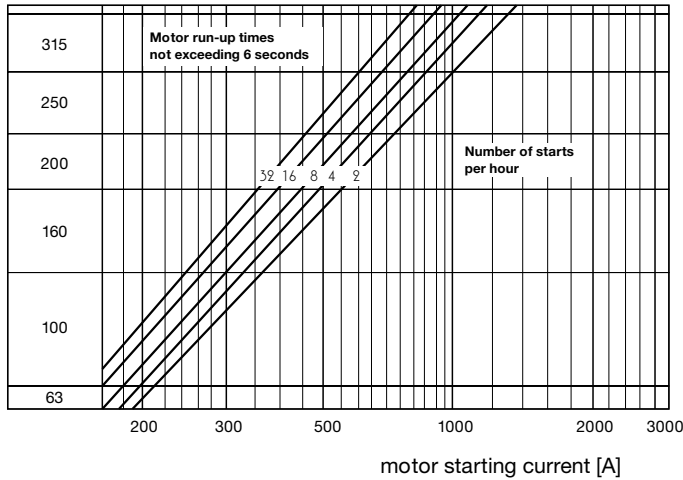

Fuselink rating [A]

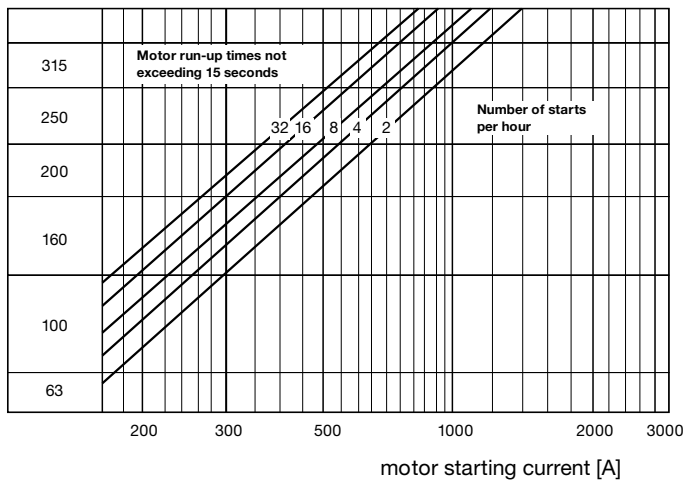

Fuselink rating [A]

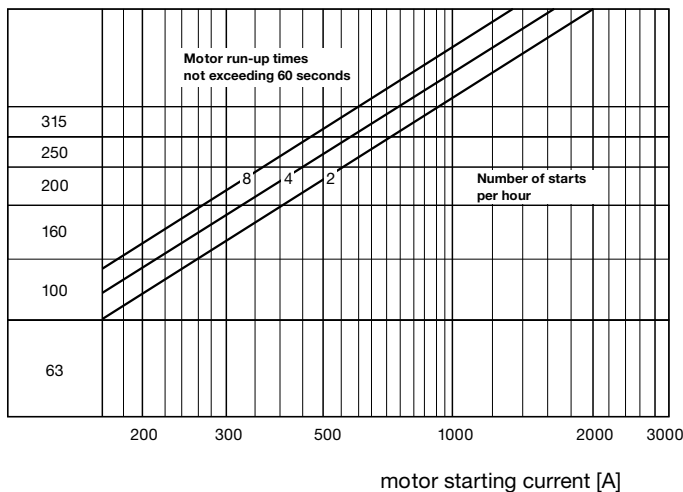

10. Choice of fuse links

Choice of rated voltage U_N

The rated voltage of the fuse links must be equal to, or higher than the operating line voltage. By choosing fuse link rated voltage considerably higher than the line voltage, the maximum arc voltage must not exceed the insulation level of the network.

Choice of rated current I_N

The minimum permissible current rating of the fuse link for motor protection may be determined from the selection charts I, II and III. The three different charts are for run-up times of 6, 15 and 60 seconds respectively. Each chart contains different characteristics, depending on the number of starts per hour. Of this specific number of starts per hour, the first two are in immediate succession, the rest being evenly spaced in the 1 hour period. The number of starts per hour indicates the time interval between separate starts. For example, 4 starts in 15 minutes are represented by 16 starts per hour.

On the horizontal axis of the selection chart, the motor starting current is given, and along the vertical axis the current rating of the fuse link is found.

Selection procedure:

- Select the charts which are appropriate for the run-up time of the motor,
- select the starting current along the horizontal axis,
- depending on the number of starts per hour, select the correct characteristic (2, 4, 8, 16, 32),
- read of the correct rating of the fuse link on the vertical axis.

Example:	A	B
Starting current of the motor	850A	250A
Run-up time	6 sec.	15 sec.
Number of starts per hour	2	16
Chart number	1	2
Rated current of fuse link	250A	160A

Fuse link type CMF

11. Replacement of melted fuse links

CMF fuse link cannot be regenerated. According to IEC, Publication 282-1, all 3 fuse links should be replaced, even if only 1 or 2 of the fuse links in the threephase system have operated. Exceptions are allowed when it can be verified that the fuse link(s) have not experienced any overcurrent.

12. The K-factor

According to the IEC 644, the K-factor is a factor (less than unity) defining an overload characteristic to which the fuse link may be repeatedly subjected under specified motor starting conditions without deterioration. The overload characteristic is obtained by multiplying the current on the prearcing characteristic (melting time characteristics) by K. The Value of K given in the data table is chosen at 10 seconds melting time, and is valid for melting times between 5 and 60 seconds.

13. Data and dimensions CMF

U_N	I_N	e	D	K*	I_1	I_3	R_0	P_N	Minimum	Maximum
kV	A	mm	mm	-	kA	A	mΩ	Watt	Pre-arc A ² s	Interruption A ² s
3,6	100	292	65	0,75	50	275	3,25	49	$1,4 \cdot 10^4$	$17 \cdot 10^4$
	160	292	65	0,7	50	400	1,94	75	$3,8 \cdot 10^4$	$50 \cdot 10^4$
	200	292	87	0,7	50	500	1,42	75	$7,6 \cdot 10^4$	$71 \cdot 10^4$
	250	292	87	0,6	50	760	1,03	90	$14 \cdot 10^4$	$115 \cdot 10^4$
	315	292	87	0,6	50	900	0,85	122	$21 \cdot 10^4$	$180 \cdot 10^4$
7,2	63	442	65	0,75	50	175	8,63	45	$0,48 \cdot 10^4$	$6,5 \cdot 10^4$
	100	442	65	0,75	50	275	4,93	67	$1,40 \cdot 10^4$	$18 \cdot 10^4$
	160	442	65	0,7	50	400	2,96	119	$3,8 \cdot 10^4$	$54 \cdot 10^4$
	200	442	87	0,7	50	500	2,15	118	$7,6 \cdot 10^4$	$75 \cdot 10^4$
	250	442	87	0,6	50	800	1,56	142	$14 \cdot 10^4$	$120 \cdot 10^4$
	315	442	87	0,6	50	950	1,30	193	$21 \cdot 10^4$	$220 \cdot 10^4$
12	63	442	65	0,75	50	190	13,3	77	$0,48 \cdot 10^4$	$11 \cdot 10^4$
	100	442	87	0,75	50	275	6,72	103	$1,4 \cdot 10^4$	$20 \cdot 10^4$
	160	442	87	0,7	50	480	4,04	155	$3,8 \cdot 10^4$	$70 \cdot 10^4$
	200	442	87	0,7	50	560	2,89	173	$9,3 \cdot 10^4$	$91 \cdot 10^4$

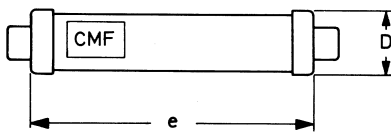

*) The K-factor is referred to the average value of current.

Legends:

e = see figure

D = see figure

K = K-factor acc. to IEC 644

I_1 = max. short circuit current tested

I_3 = minimum breaking current

R_0 = resistance at room temperature

P_N = power loss at rated current

ABB is working to continuously improve the products. Therefore we reserve the right to change design, dimension and data without prior notice.

This product has been certified by ABB Group as **Industrial IT Enabled™ - Information Level**. All product information is supplied in interactive electronic format, based on ABB Aspect Object™ technology. The Industrial IT commitment from ABB ensures that every enterprise building block is equipped with the integral tools necessary to install, operate, and maintain it efficiently throughout the product lifecycle.



ABB Sp. z o.o.

Power Technologies Division

ul. Leszno 59

06-300 Przasnysz, Poland

Phone: (+48 22) 51 52 838, 51 52 831

(+48 29) 75 33 233, 75 33 240

Fax: +48 22 51 52 659, +48 29 75 33 327

e-mail: export.plzwa@pl.abb.com

www.abb.com