

Bjorn Stand System for Light Grids and Mirrors

Bjorn is a very stable and flexible stand system in which Focus II Safety Light Curtains/Grids and Mirrors are mounted in the stand. The hardware for the mirrors in the stand can be turned to provide either vertical or horizontal angles. The robust material of the Bjorn protects Focus II units from direct collisions, thus preventing unnecessary material damage and halts in production.

Applications:

- Protects mirrors and Light Curtains and Light Grids

Features:

- Robust
- Adjustable

Bjorn technical data

Manufacturer	ABB JOKAB SAFETY
Ordering information	see page 43
Color	Yellow powder-coated (RAL 1018)
Material	3 mm steel
Dimensions	
Cross section	146 mm x 130 mm
Foot	230 mm x 190 mm
Weight	
H2, V2 and N2	15 kg/piece
H3	17 kg/piece
H4-1, H4-2	20 kg/piece
N5	27 kg/piece
Mirror reduction	≤10 %

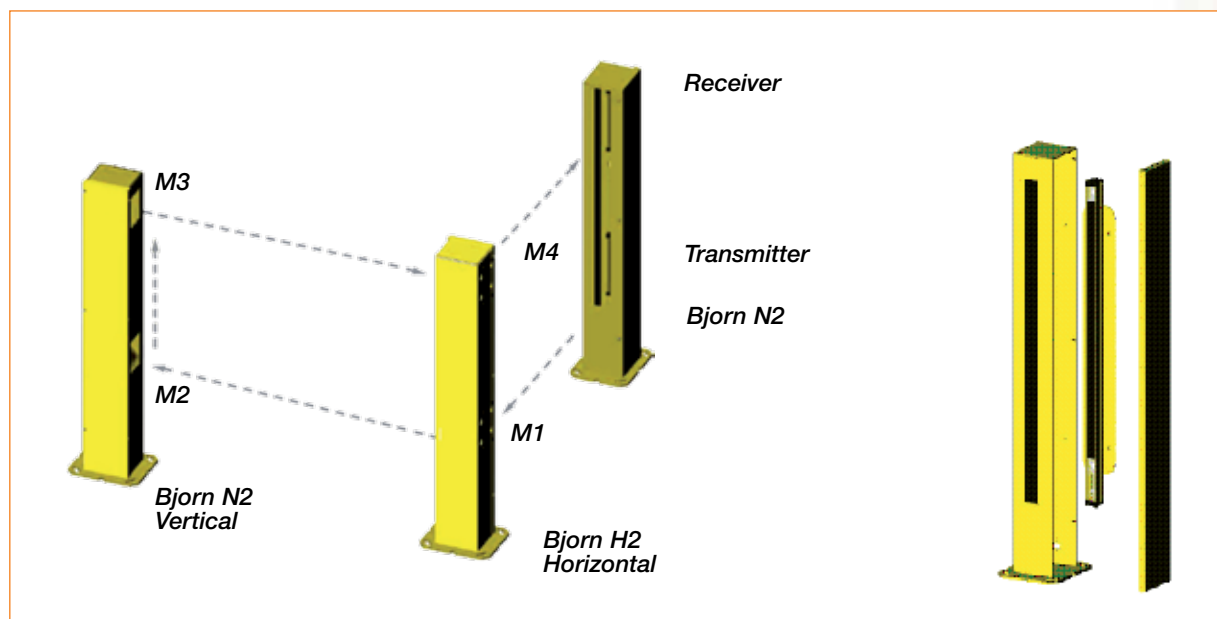

Bjorn dimensions

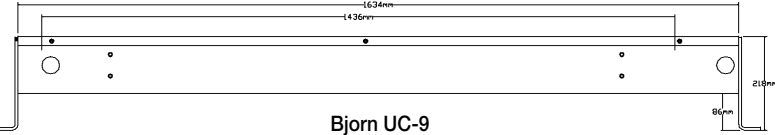
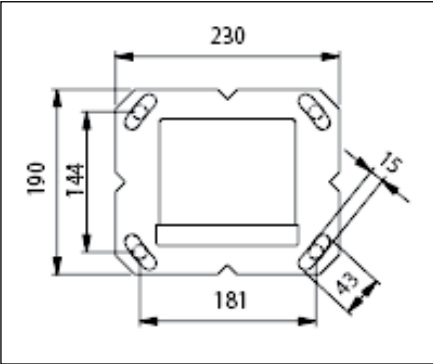

Bjorn UC-9

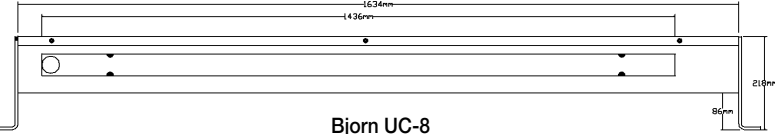

Bjorn UC-8

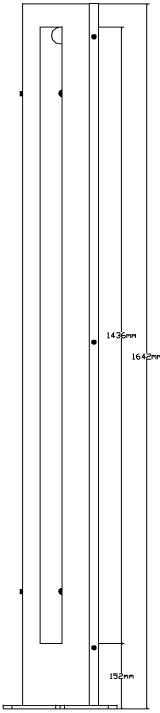

Bjorn UC-10

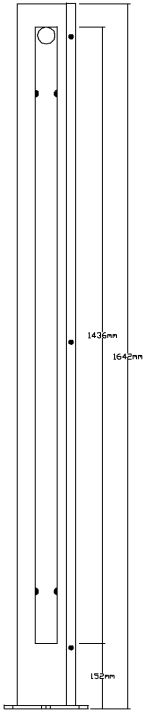

Bjorn UC-3

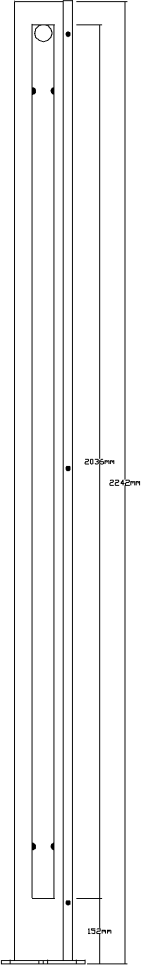

Bjorn UC-4

Mirrors

	Product	Catalog number	Description
	MFII-300	2TLA022041R0200	Mirror, 362mm for Focus
	MFII-450	2TLA022041R0300	Mirror, 512mm for Focus
	MFII-600	2TLA022041R0400	Mirror, 658mm for Focus
	MFII-750	2TLA022041R0500	Mirror, 801mm for Focus
	MFII-900	2TLA022041R0700	Mirror, 958mm for Focus
	MFII-1200	2TLA022041R0800	Mirror, 1258mm for Focus
	MFII-1500	2TLA022041R0900	Mirror, 1551mm for Focus
	MFII-1650	2TLA022041R1000	Mirror, 1709mm for Focus
	MFII-1350	2TLA022041R1300	Mirror, 1408mm for Focus
		2TLA022041R2000	Bracket for MF mirror
		2TLA850010R0900	2000mm Quick Guard Stand 44mmx88mm Light Curtain/Mirror mounting post with endcaps and 2 floor mounts.

Bjorn support for Light Grids and Mirrors

	Product	Catalog number	Description
	Bjorn UC-3	2TLA850210R6100	Protective floor mounted housing for 1 vertically mounted Focus Light Curtain or Grid up to 1200mm in length.
	Bjorn UC-4	2TLA850310R1700	Protective floor mounted housing for 1 vertically mounted Focus Light Curtain or Grid up to 1800mm in length.
	Bjorn UC-8	2TLA850210R8300	Left hand protective floor mounted housing for 1 horizontally mounted Focus Light Curtain or Grid up to 1200mm in length.
	Bjorn UC-9	2TLA850210R8700	Right hand protective floor mounted housing for 1 horizontally mounted Focus Light Curtain or Grid up to 1200mm in length.
	Bjorn UC-10	2TLA850120R5500	Protective floor mounted housing for 2 vertically mounted Focus Light Curtains or Grids at 90 degrees up to 1200mm in length.

Wet Wash Down Tubes

	Product	Catalog number	Description
	WET-150 FII	2TLA022038R4000	Wash down tube kit for use with 150mm Focus Safety Light Curtains
	WET-300 FII	2TLA022038R4100	Wash down tube kit for use with 300mm Focus Safety Light Curtains
	WET-450 FII	2TLA022038R4200	Wash down tube kit for use with 450mm Focus Safety Light Curtains
	WET-600 FII	2TLA022038R4300	Wash down tube kit for use with 600mm Focus Safety Light Curtains
	WET-750 FII	2TLA022038R4400	Wash down tube kit for use with 750mm Focus Safety Light Curtains
	WET-900 FII	2TLA022038R4500	Wash down tube kit for use with 900mm Focus Safety Light Curtains
	WET-1050 FII	2TLA022038R4600	Wash down tube kit for use with 1050mm Focus Safety Light Curtains
	WET-1200 FII	2TLA022038R4700	Wash down tube kit for use with 1200mm Focus Safety Light Curtains
	WET-1350 FII	2TLA022038R4800	Wash down tube kit for use with 1350mm Focus Safety Light Curtains
	WET-1500 FII	2TLA022038R4900	Wash down tube kit for use with 1500mm Focus Safety Light Curtains
	WET-1650 FII	2TLA022038R5000	Wash down tube kit for use with 1650mm Focus Safety Light Curtains
	WET-1800 FII	2TLA022038R5100	Wash down tube kit for use with 1650mm Focus Safety Light Curtains
	WET-K500 FII	2TLA022038R5200	Wash down tube kit for use with 500mm Focus Safety Light Grids
	WET-K800 FII	2TLA022038R5300	Wash down tube kit for use with 800mm Focus Safety Light Grids
	WET-K900 FII	2TLA022038R5400	Wash down tube kit for use with 900mm Focus Safety Light Grids
	WET-K1200 FII	2TLA022038R5500	Wash down tube kit for use with 1200mm Focus Safety Light Grids.
	WET-MF-T FII	2TLA022038R1700	Wash down tube kit for use with 500mm Focus Safety Light Transceivers
	WET-MF-L FII	2TLA022038R1800	Wash down tube kit for use with 500mm Focus Safety Light Transceivers