

RENEWAL PARTS [GE LEGACY DOCUMENT]

Metal-clad switchgear

Types M-26 and M-36

GE legacy product
documentation

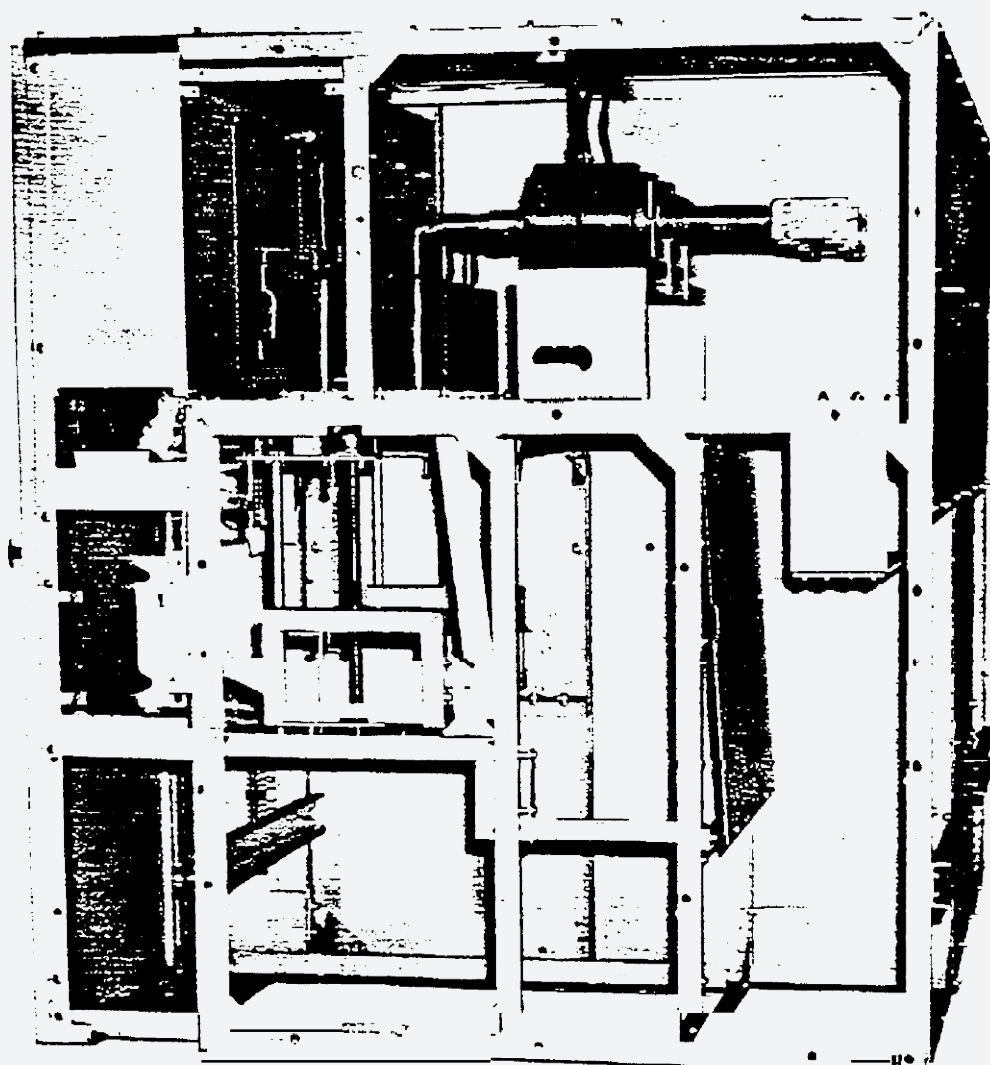

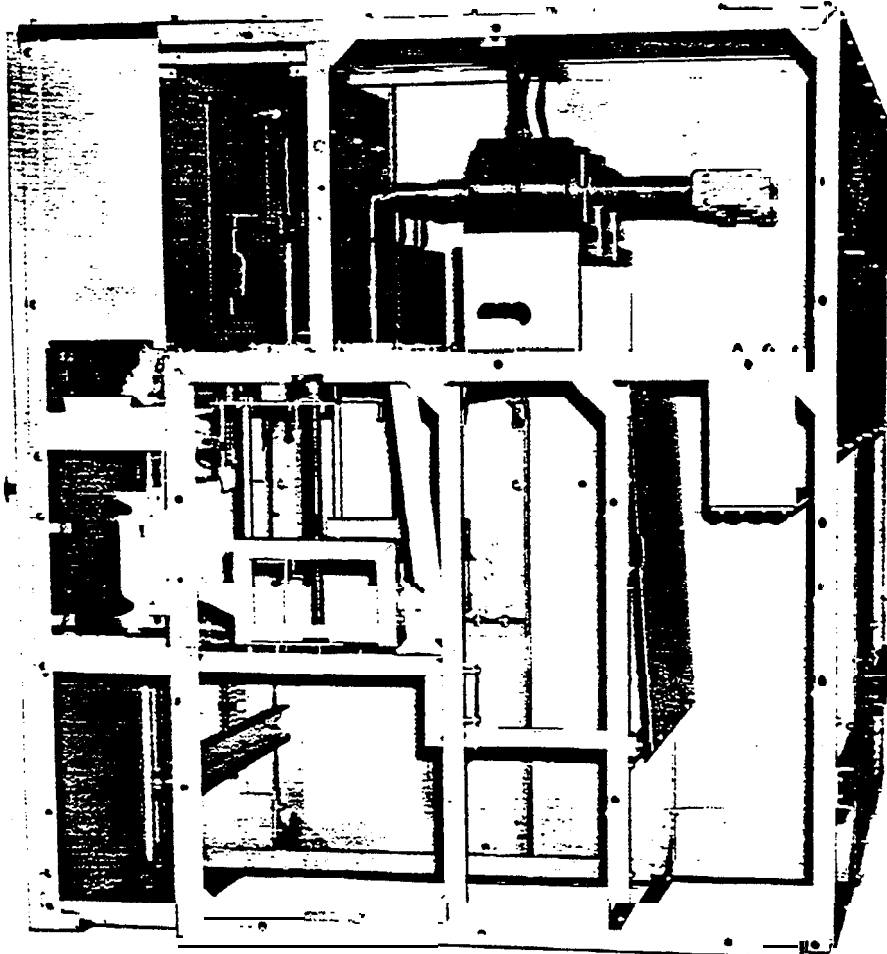

GENERAL ELECTRIC
SWITCHGEAR
REQ.
SUM.
ELEM.



ORDERING INSTRUCTIONS

1. Always specify the complete nameplate data of the equipment.
2. Specify the quantity, catalog number (if listed), reference number (if listed), description, and this bulletin number.
3. Standard hardware, such as screws, bolts, nuts, washers, etc., is not listed in this bulletin. Such items should be purchased locally.
4. For prices, refer to the nearest office of the General Electric Company.

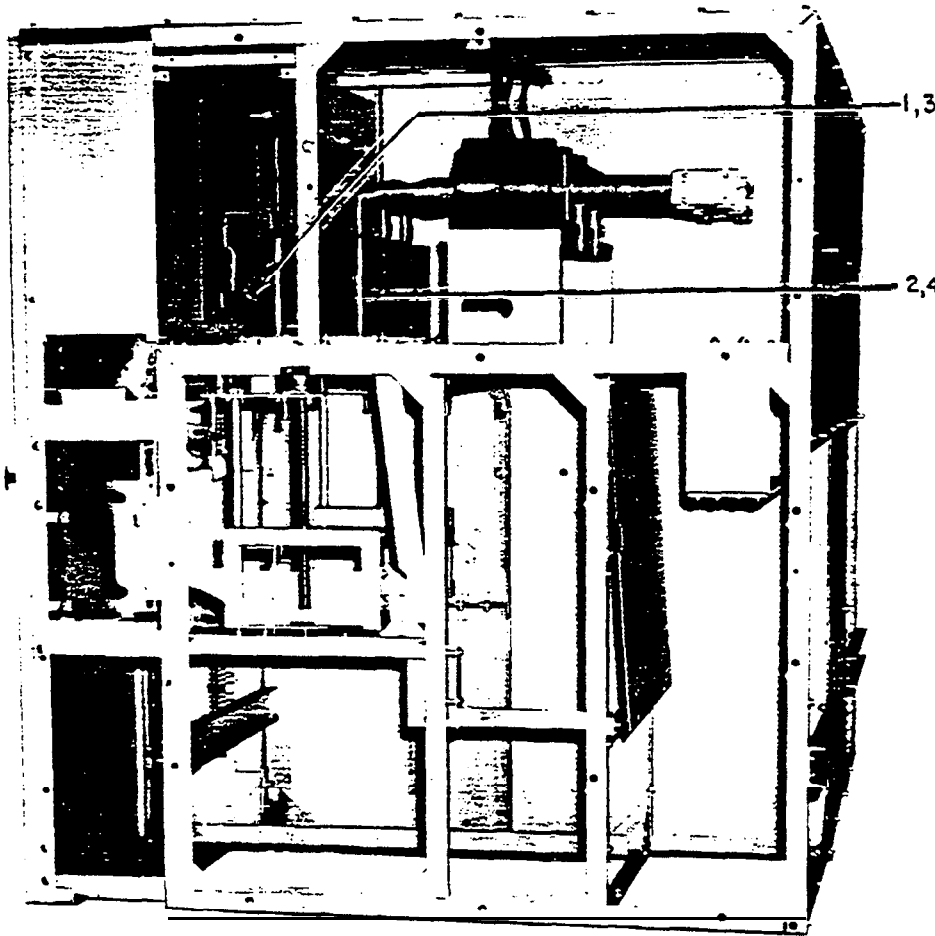

Fig. 1 Metal-clad switchgear

NOTE: The NP data listed below must be supplied for identification.

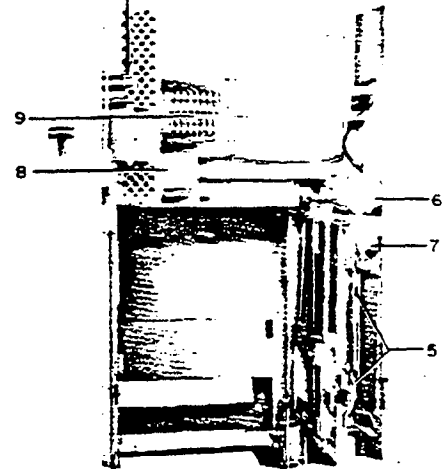
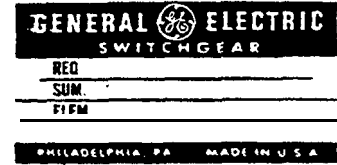

Fig. 2 Motor and control unit

Ref. NO.	KY	Amps	Ordering Number	Description
*1	4.16	1200	7-328X600	Front primary disconnect
*1	4.16	2000	328X601	Front primary disconnect
*1	4.16	3000	328X602	Front primary disconnect
*1	13.8	1200	328X603	Front primary disconnect
*1	13.8	2000	328X604	Front primary disconnect
*1	13.8	2500	328X605	Front primary disconnect
*1	13.8	3000	326X606	Front primary disconnect
*2	4.16	1200	328X607	Rear primary disconnect
*2	4.16	2000	328X608	Rear primary disconnect
*2	4.16	3000	328X609	Rear primary disconnect
*2	13.8	1200	328X610	Rear primary disconnect
*2	13.8	2000	328X611	Rear primary disconnect
*2	13.8	2500	328X612	Rear primary disconnect
1 2	13.8	3000	328X613	Rear primary disconnect
3	4.16	1200	328X614	Front installation accessories
3	4.16	2000	328X615	Front installation accessories
3	4.16	3000	326X616	Front installation accessories
3	13.8	1200	328X617	Ront installation accessories
3	13.8	2000	328X618	Ront installation accessories
3	13.8	2500	328X619	Front installation accessories
3	13.8	3000	328X620	Front installation accessories
4	4.16	1200	328X621	Rear installation accessories
4	4.16	2000	328X622	Rear installation accessories
4	4.16	3000	326X623	Rear installation accessories
4	13.8	1200	328X624	Rear installation accessories
4	13.8	2000	328X625	Rear installation accessories
4	13.8	2500	328X626	Rear installation accessories
4	13.8	3000	328X627	Rear installation accessories

*Recommended spare parts. Suggested one for every ten identical units.
 One for every ten outside of the U.S. A.

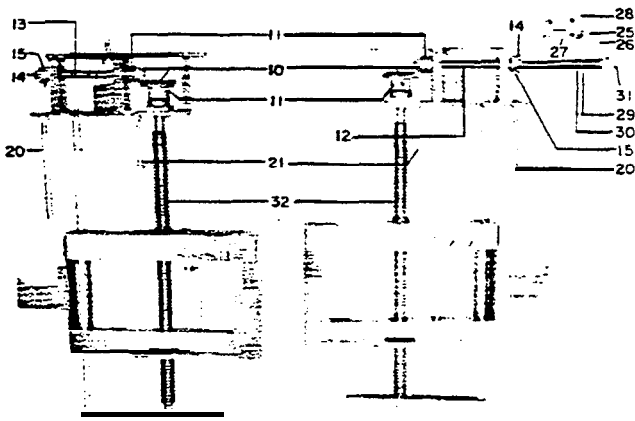

Fig. 3 Elevating mechanism for M-26 equipments rated 250 mva and M-36 rated 1200A 500 mva

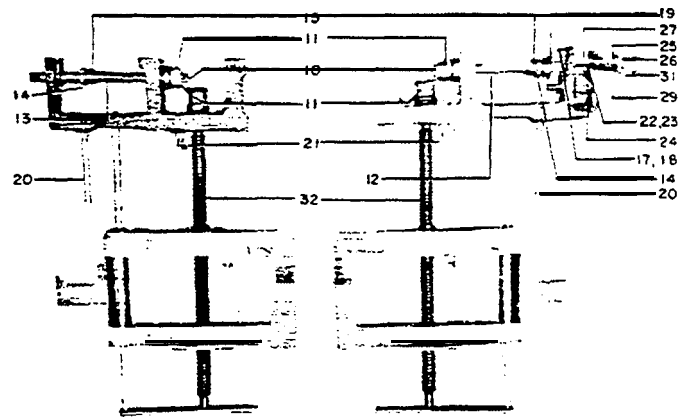

Fig. 4 Elevating mechanism for M-36H equipments rated 750, M-26H rated 350 mva and M-36 rated 500 mva 2000A

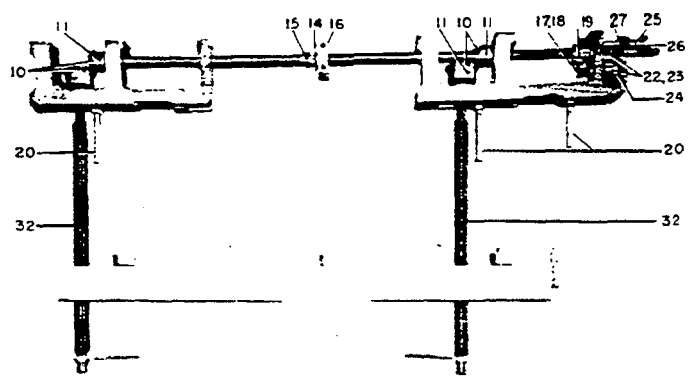
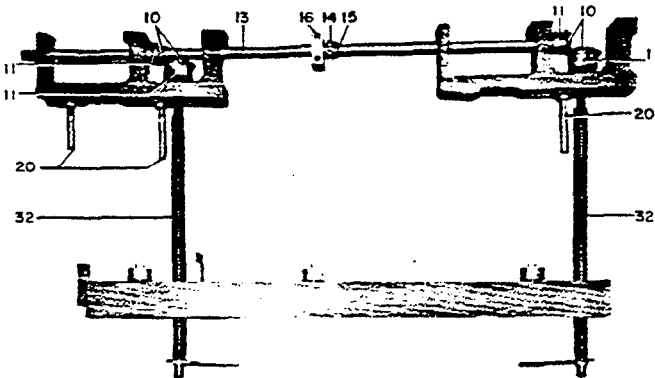

Fig. 5 Elevating mechanism for M-36HH equipments rated 1000 mva

Ref. No.	Ordering Number	Description
*5	773328X628	Positive mechanical interlock assembly, complete
6	328X629	Elevating mechanism motor
7	328X630	Spring
*8	328X631	Complete secondary disconnect device
*9	328X632	Complete stationary auxiliary switch mechanism
10	328X633	Miter gears, pair
11	328X634	Roll pin for miter gears
12	328X635	Shaft, right
13	328X636	Shaft, left
14	328X637	Sprocket
15	328X638	Roll pin for sprocket
16	328X639	Bearing block
17	328X640	Spur gear
18	328X641	Pinion gear and rod
19	328X642	Roll pin for spur gear
20	328X643	stop stud
21	328X644	stop bolt
22	328X645	Pinion gear and rod
23	328X646	Spur gear
24	328X647	Roll pin for spur gear
25	328X648	Locking spring
26	328x849	Stop shaft
27	328X650	Roll pin for stop shaft
28	328X651	Bracket for stop shaft
29	328X652	Clutch spring
30	328X653	Roll pin for clutch spring
31	328X654	Slide clutch
32	328X655	Jack screw

Whenever gears mesh, they must be ordered as a pair.

*Recommended spare parts. Suggested one for every ten identical units.
One for every ten outside of the U.S. A.

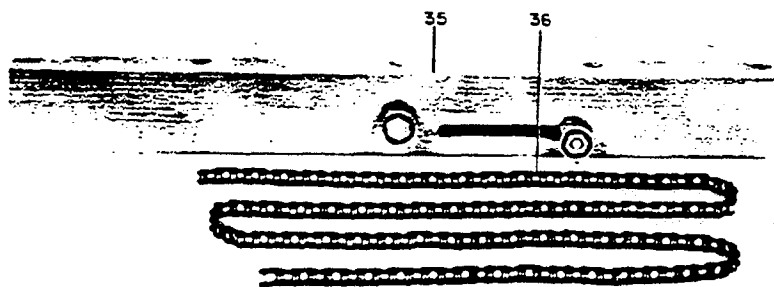

Fig. 6 Angle bracket and chain

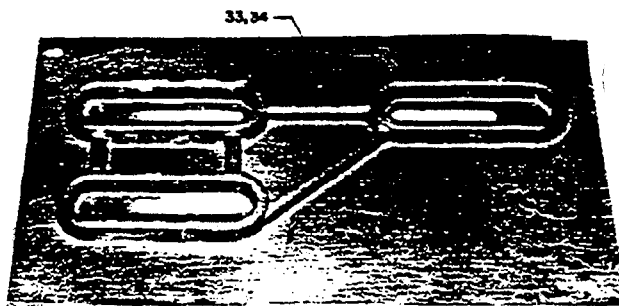

Fig. 10 Bus support, molded

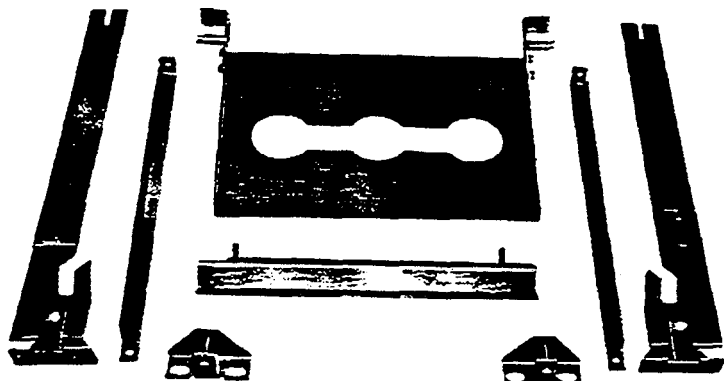

Fig. 7 Shutter mechanism M-26 (Ref. 37)

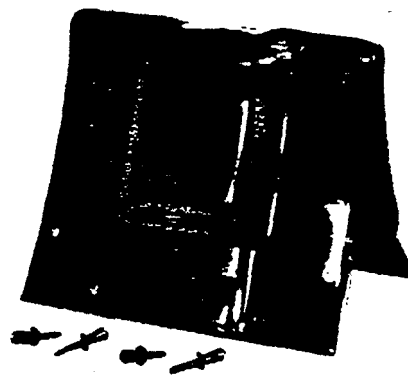

Fig. 11 Bus connection boot (4.16 KV and 13.8 KV)
Specify unit No. and phase on which boot is to be used

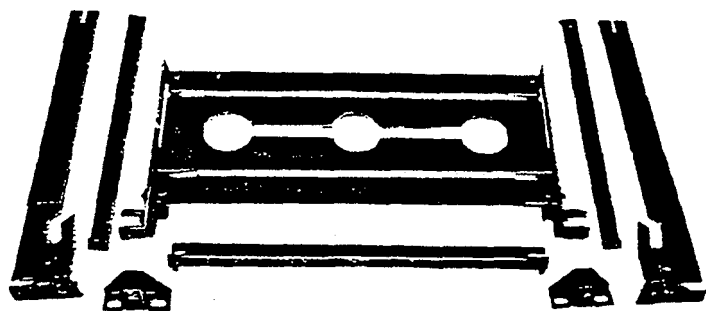

Fig. 8 Shutter mechanism M-36 (Ref. 38)

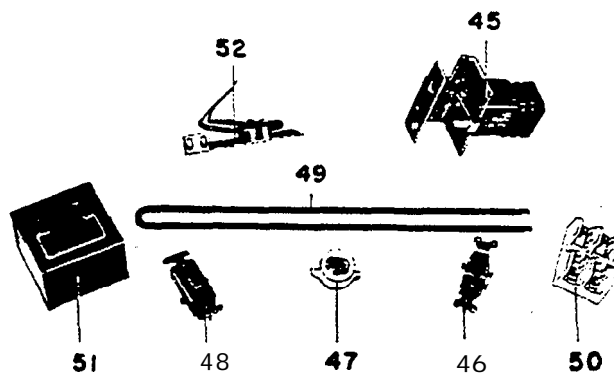

Fig. 12 Wiring devices and miscellaneous

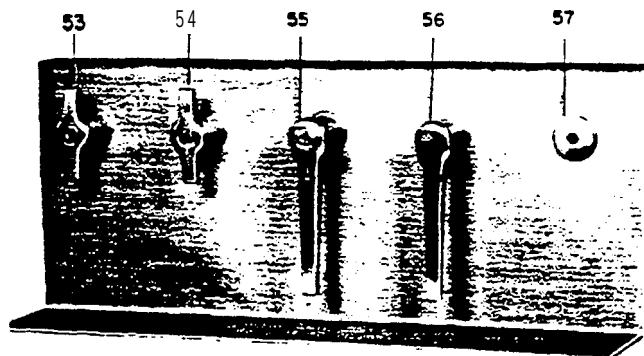

Fig. 13 Door handles and locks

Ref. No.	Ordering Number	Description
33	7-328X656	Bus support, 5KV
34	328X657	Bus support, 15KV
35	328X658	Bracket assembly
*36	328X659	Chain
*37	328X660	Shutter mechanism assembly (M26)
*38	328X661	Shutter mechanism assembly (M36)
*45	328X668	Limit switch, Type SBI
46	328X669	Light switch
47	328X670	Keyless receptacle
48	328X671	Duplex receptacle
49	328X672	Strip heater
60	328X673	Fuse block, open type
*51	328X674	Fuse block, dead front
52	328X675	Limit switch, mercury type
53	328X676	Panel locking handle
54	328X677	Panel handle
55	328X678	Door locking handle
56	328X679	Door handle
57	328X680	Socket

Specify amp rating of fuse and number of poles

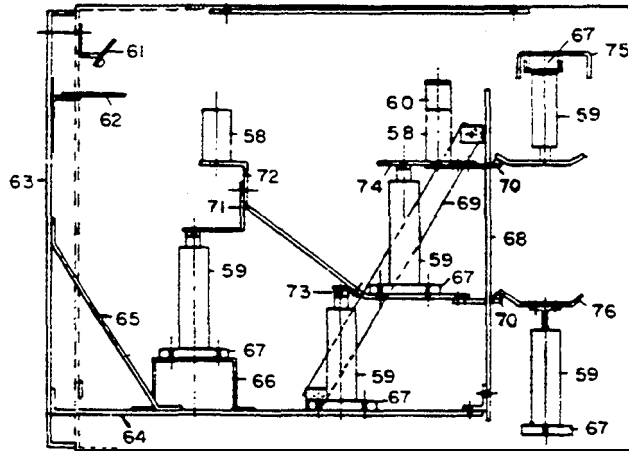

Fig. 14. Fuse rollout unit

‡ ROLLOUT UNIT

Fig. No.	Ref. No.	Ordering Number for			Description
			5K	15KV	
14	58	733-328X681	G1	G2	Fuse clip
14	*59	328X682	G1	a	Insulator
14	60	328X683	G1	G2	Ground bar
14	*61	328X684	G1	G2	Ground finger
14	62	328X685	G1	G2	Barrier
14	63	328X686	Δ	G2	Cover
14	64	328X687	G1	G2	Tray
14	65	328X688	G1	a	Strap
14	66	328X689	Δ	G2	Insulator support
14	67	328X690		a	Insulator clamp
14	68	328X691	G1	a	Barrier
14	69	328X692	G1	a	Compound strap

‡All rollout units and potheads can be either 5 KV or 15 KV. When ordering give complete ordering number plus C1 for 5 KV and G2 for 15 KV.

ΔDoes not apply to 5 KV unit.

*Recommended spare parts. Suggested one for every ten identical units. One for every ten outside of the U.S.A.

METAL-CLAD SWITCHGEAR

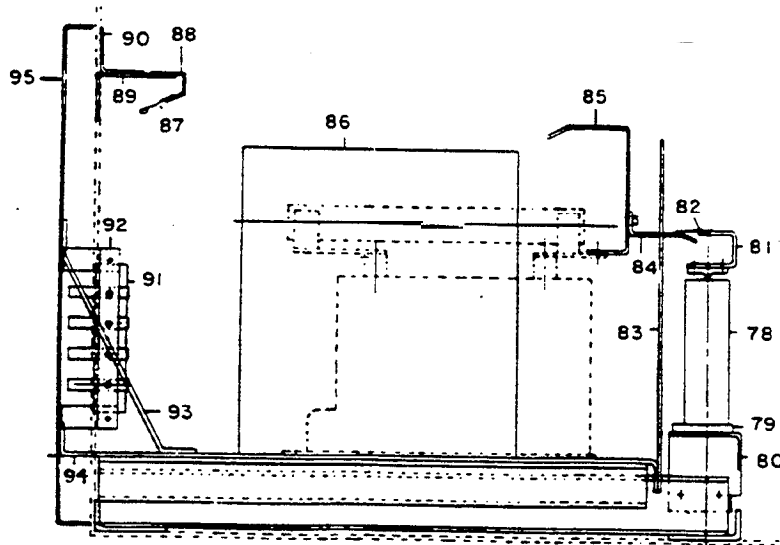

Fig. 15 Potential transformer rollout unit

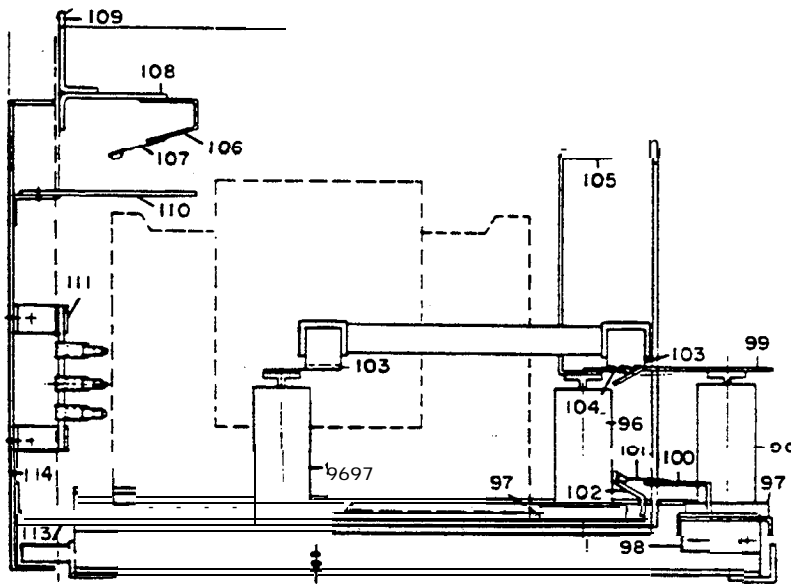

Fig. 16 Control power transformer rollout unit

NOTE: Figure No. 17 and Ref. No's 115 thru 129 have been removed and these parts are no longer available.

‡ ROLLOUT UNIT (Cont'd)

Fig. No.	Ref. No.	Ordering Number for			Description
			5K	15KV	
14	*70	733-328X693	G1	G2	Finger
14	71	328X694	Δ	G2	Connection bar
14	72	328X695	G1	G2	Connection bar
14	73	328X696	Δ	G2	Connection bar
14	74	328X697	G1	G2	Connection bar
14	*75	328X698	G1	G2	Connection bar
14	*76	328X699	G1	G2	Connection bar
15	*78	328X701	G1	G2	Insulator
15	79	328X702	Δ	G2	Insulator clamp
15	80	328X703	G1	G2	Insulator support
15	*81	328x704	G1	G2	Disconnect bar
15	*82	328X705	G1	G2	Finger
15	83	328X706	G1	G2	Barrier
15	*84	328X707	G1	G2	Disconnect bar
15	*85	328X708	G1	G2	Disconnect bar
15	86	328X709	4	G2	Barrier
15	*87	328X710	G1	G2	Ground finger
15	88	328X711	G1	G2	Ground finger support
15	89	328X712	G1	G2	Ground finger support
15	90	328X713	G1	G2	Barrier
15	91	328X714	G1	G2	Secondary disconnect (stationary)
15	92	328X715	G1	G2	Secondary disconnect (movable)
15	93	328X716	G1	G2	Brace
15	94	328X717	G1	G2	Tray
15	95	328X718	G1	G2	Cover
16	*96	328X719	G1	G2	Insulator
16	97	328X720	Δ	G2	Insulator clamp
16	98	328X721	G1	G2	Insulator support
16	*99	328X722	G1	G2	Contact bar
16	100	328X723	G1	G2	Ground finger support
16	*101	328X724	G1	G2	Ground finger
16	*102	328X725	G1	G2	Ground shoe contact
16	103	328X726	G1	G2	Fuse clip
16	*104	328X727	G1	G2	Primary contact
16	105	328X728	G1	G2	Ground bar
16	106	328X729	G1	G2	Ground finger support
16	*107	328X730	G2		Ground finger
16	108	328X731	Δ	G2	Cross angle
16	109	328X732	G1	G2	Barrier
16	110	328X733	Δ	G2	Barrier
16	*111	328X734	G1	G2	Secondary disconnect (movable)
16	*112	320X735	G1	G2	Secondary disconnect (stationary)
16	113	328X736	G1	G2	Tray
16	114	328X737	G1	G2	Cover

‡ All rollout units can be either 5 KV or 15 KV. When ordering give complete ordering number plus G1 for 5 and G2 for 15 KV.

Δ Does not apply to 5 KV unit.

*Recommended spare parts. Suggested one for every ten identical units. One for every ten outside of the U.S.A.

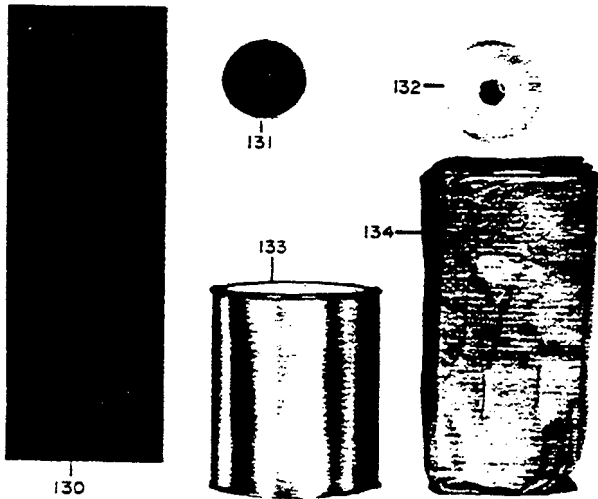
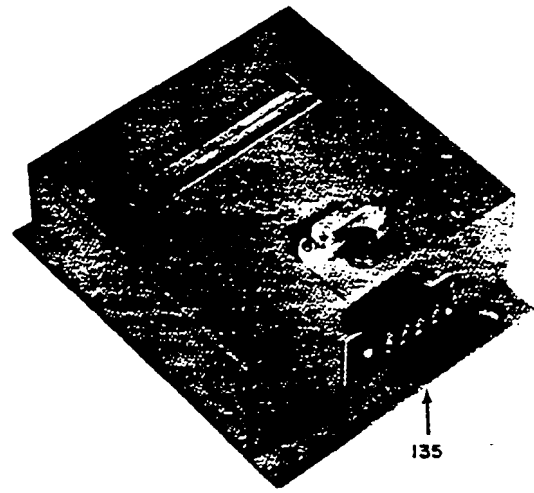
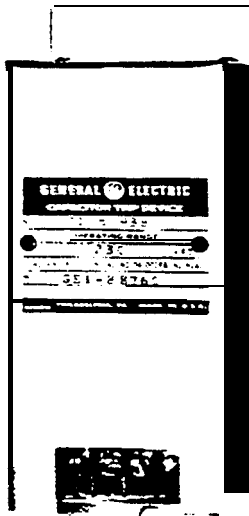

Fig. 18 Taping material for bus connection joints



Refer to GEI-77065

Fig. 19 Auto-charged trip device



Refer to GEI-88760

Fig. 20 Capacitor trip device

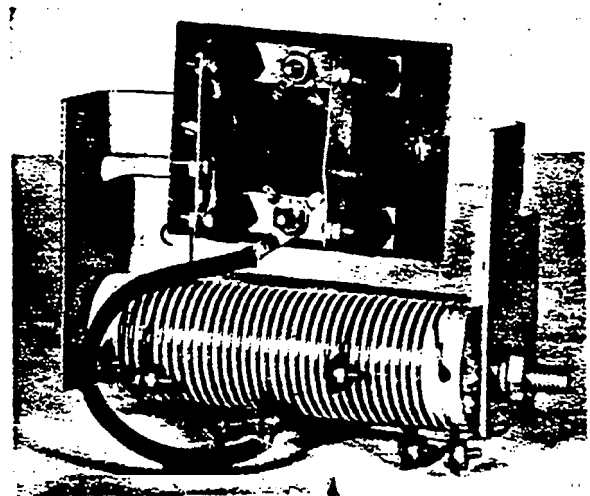

Refer to GEI-77007C

Fig. 21 Silicon rectifiers for circuit breaker closing service

ACCESSORIES

Ref. No.	Ordering Number	Description
130	733-328X753	Irrathene [®] tape (I-202) 4 in. wide by 21 in. long piece (for 1200 amp joint)
130	328X754	Irrathene tape (I-202) 4 in. wide by 29 in. long piece (for 2000 amp joint)
131	328X755	Irrathene tape (I-202) 1 1/2 in. wide by 25 ft roll
132	328X756	Glass cloth tape (A2L12B) 1 1/2 in. wide by 36 yd roll
133	328X757	Black insulating varnish (U-311) (for 2.4 KV and 4.16 KV)
133	328X758	Brown insulating varnish (U-310) (for 7.2 KV and 13.8 KV)
134	328X759	Packing compound (A50H119) 5 lb package
135	328X760	Auto charged trip device (ST-230)
136	328X761	Capacitor trip device
137	328X762	Silicon rectifier assembly for circuit breaker closing service



ABB Inc.

Electrification Services
305 Gregson Dr.
Cary, NC 27511 USA

For further information, please visit:
www.electrification.us.abb.com/services

For service, call:
1-888-434-7378 (US)
1-540-387-8617 (International)

The information contained in this document is for general information purposes only. While ABB strives to keep the information up to date and correct, it makes no representations or warranties of any kind, express or im-plied, about the completeness, accuracy, reliability, suitability or availability with respect to the information, products, services, or related graphics contained in the document for any purpose. Any reliance placed on such information is therefore strictly at your own risk. ABB reserves the right to discontinue any product or service at any time.

© Copyright 2023 ABB. All rights reserved.