

**Top View**

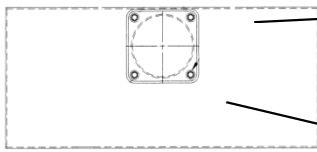

**Hub Dimensions**

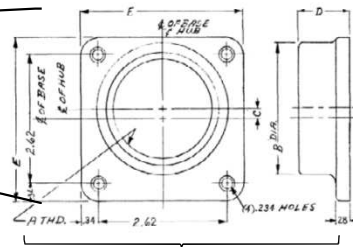

**Hub**

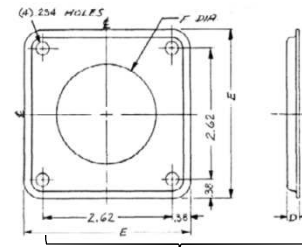

**Closing Cap**

**Available Hubs**

Cat#	Mod#	A-THD	B-DIA	C	D	E
TC75	2	" $\frac{3}{4}$ "-14"	1.31	0.81	1.03	3.31
TC100	2	"1 - 11 $\frac{1}{2}$ "	1.53	0.69	1.03	3.31
TC125	2	"1 $\frac{1}{4}$ " - 11 $\frac{1}{2}$ "	1.88	0.53	1.03	3.31
TC150	2	"1 $\frac{1}{2}$ " - 11 $\frac{1}{2}$ "	2.12	0.42	1.03	3.31
TC200	2	"2 - 11 $\frac{1}{2}$ "	2.62	0.2	1.03	3.31
TC250	2	"2 $\frac{1}{2}$ " - 8"	3.19	NONE	1.22	3.31
TCCP Closing Cap	1	NONE	NONE	NONE	0.25	3.38

**Front View**

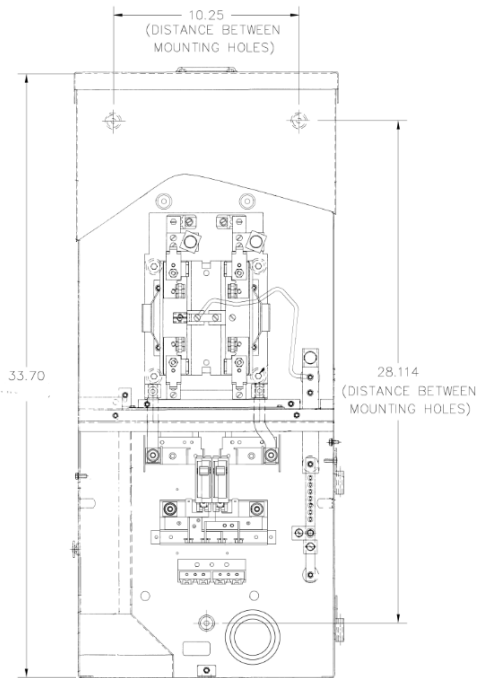

**Front Layout View**

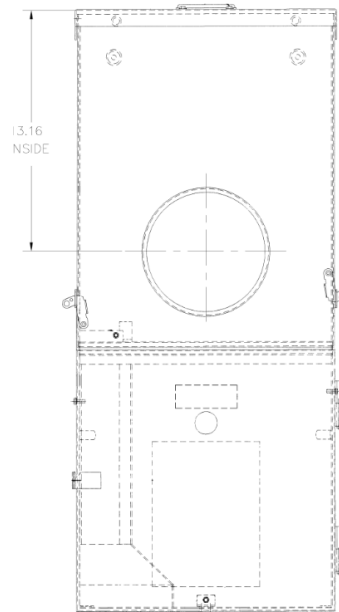

**Side View**

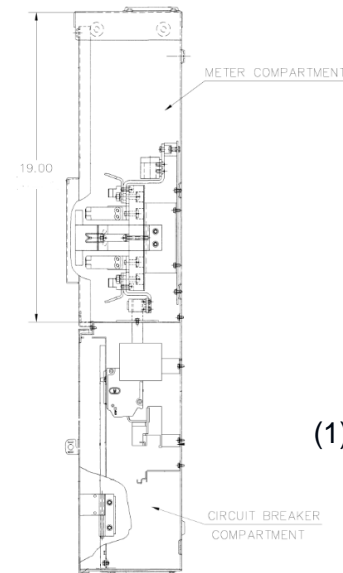

**Bottom View**

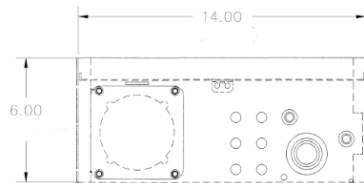

**Main Wire Size**  
(1) 3/0 - 350MCM (AL/CU)



imagination at work

Main Breaker THHQL - Ringless - 125A 22K - 4/8 Circuits - N3R Encl - Surface Front - UG/OH Incoming Feed - Horn Bypass - XCEL Listed

CAT NO	DWG DATE	REV #
TSMR412CSCU	7/1/2015	01