



CATALOG

Solutions for solar energy

Low- and medium-voltage
components, systems and services

Providing sustainable solutions for renewables



ABB is a world leading supplier of innovative technologies for renewables with a comprehensive range of solutions for solar, wind, Energy Storage Systems and EV charging

As renewables and digitalization enable fundamental changes in how we generate, distribute and consume energy, the only certainty is that new technologies are going to challenge our conceptions of what's possible. ABB is a pioneering leader in that technological innovation and we also actively innovate energy solutions that deliver value to customers in this dynamic environment.



Delivering sustainable renewables

The challenge of using renewables in the energy mix is to balance supply and demand.

Balancing renewables power supply and end-user's demand has always been a challenge, but as the renewables share of total generation in many countries is growing, this challenge is increasing. In response to this, ABB supports its customers along the complete renewables power value chain, from consulting, generation, balance of system, storage and connection up to transmission, monitoring and control, as well as maintenance and optimization.

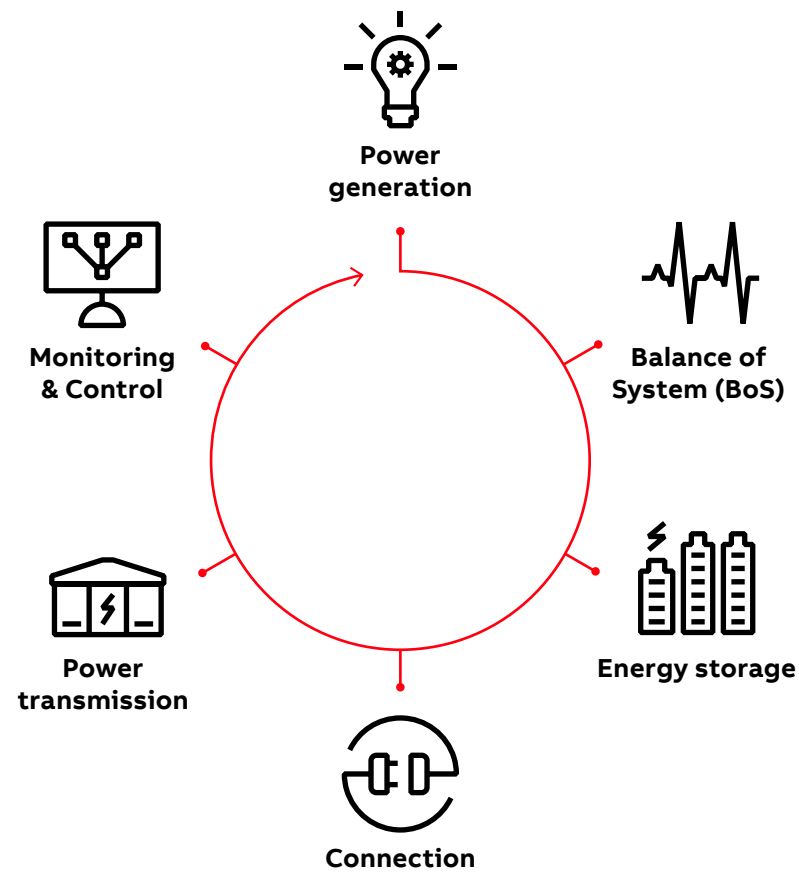

We understand the complexity of implementing solutions that are both sustainable and future-proof.



Digitalization for renewables through ABB Ability™

ABB Ability™ is our unified, cross-industry digital solution, giving you the ability to know more, do more, do better, together.

ABB Ability™ is built on a state-of-the-art hardware and software architecture for data collection, processing and storage, which has been developed together with Microsoft in order to enhance performance and guarantee the highest reliability and security.

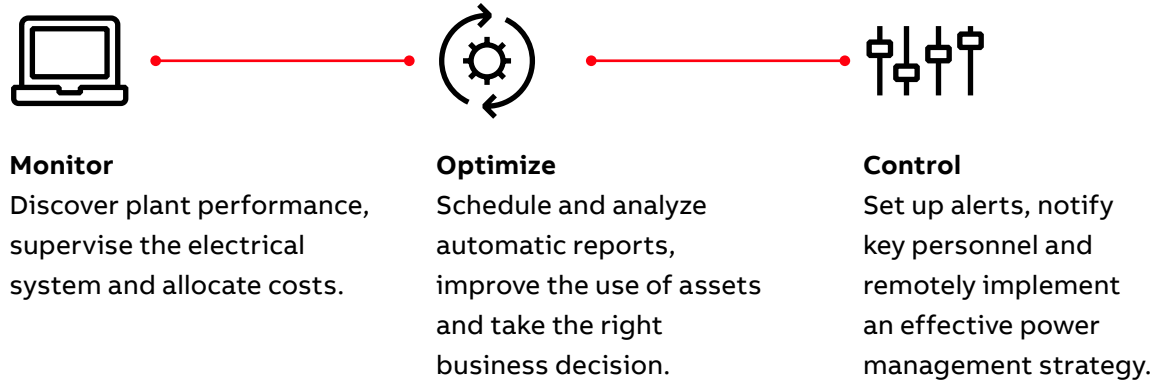

Our leading integrated and collaborative digital solutions build on our knowledge and expertise in renewables, which contributes to:

- Maximized service continuity through smart algorithms, even in an emergency
- Savings of up to 30% on operational costs through energy management system
- Reduction of more than 60% of installed components for the same function
- Switchgear footprint reduction of up to 50% by embedding logics

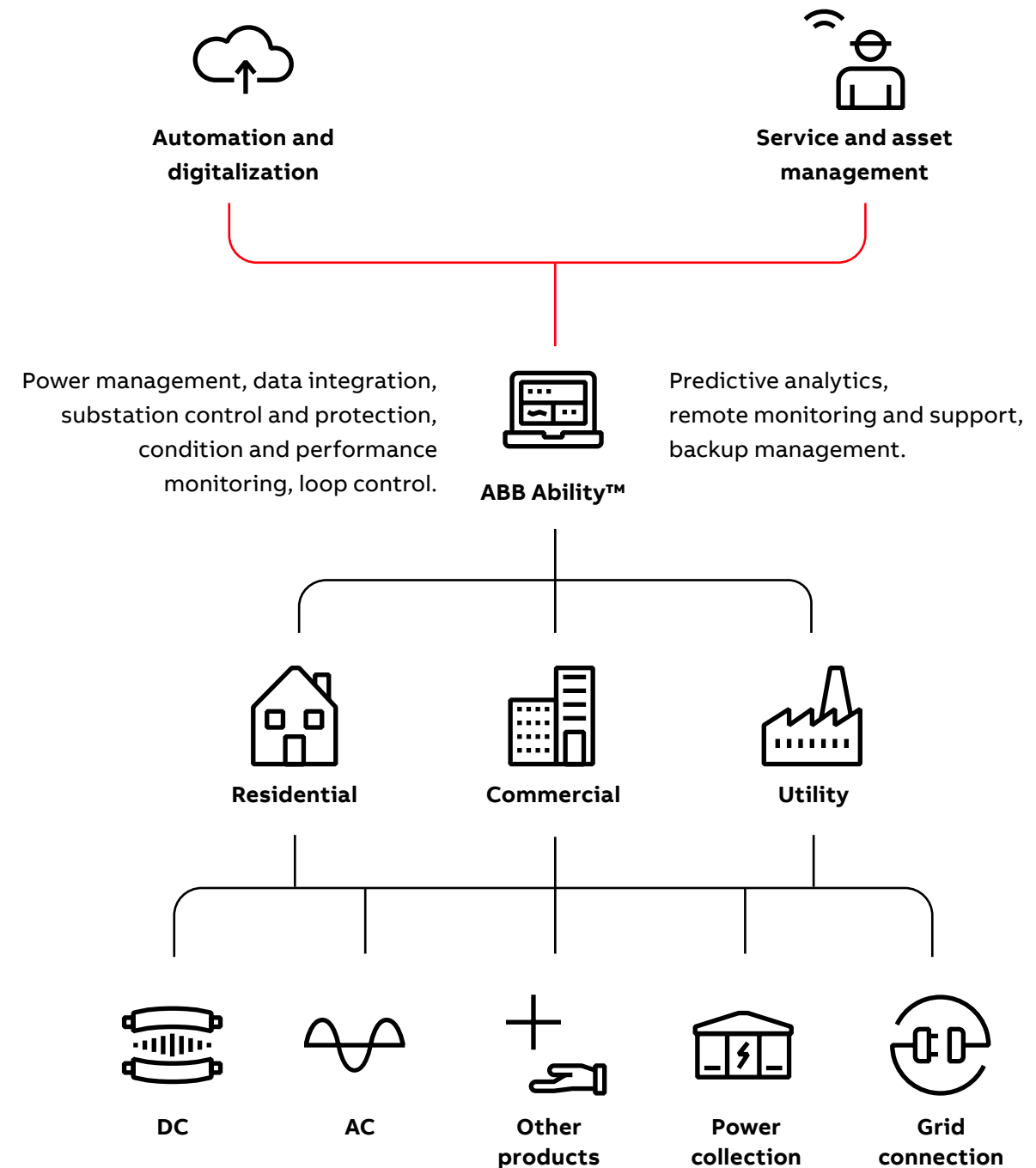

Benefits and advantages for photovoltaic

Systems, products and solutions answering customers needs and market trends. ABB portfolio for photovoltaic applications focus on delivering continuous operation, higher reliability and return on investments, enabling customers to take full advantage of savings by adopting 1500V DC and 800V AC technologies.



Reduced costs and resources

Challenge/trend Hidden costs are typically neglected, but they significantly impact any business.

ABB answer Simplified bidding and negotiation costs with one single supplier thanks to ABB's complete sun-to-socket offering can save up to 50% in time.

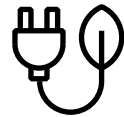

Energy efficiency

Challenge/trend The demand for lower solar energy cost and higher efficiency have pushed higher voltages and more energy efficient equipment:

800V AC:

14% savings in transformer copper windings

1500V DC:

35% savings on arrays in parallel
33% savings on array components.

ABB answer ABB's complete offering helps increase the "Electrical Balance of System" efficiency related to power losses by up to 35%, allowing more power to be delivered to the consumer.



Reliable in extreme conditions

Challenge/trend Solar plants are commonly located in high temperature environments or at high altitudes, requiring equipment that can work properly under harsh conditions: up to 70°C or 5000 m altitude.

ABB answer ABB's offering is designed taking into account the specific application requirements to deliver the most reliable solution with high performance without deratings of the main characteristics: up to 55°C or 4000 m altitude.



Continuous operation

Challenge/trend Keeping priority loads running during an utility outage is crucial for business continuity.

ABB answer ABB's power manager capabilities allow continuous operation of critical loads when an outage happens in the utility side and renewables are present.



Global availability

Challenge/trend Having the ability to streamline operations and serve multiple markets are survival factors in such a competitive market.

ABB answer ABB's multi-listed (eg.: IEC/UL/CCC and more) products and systems allow customers to export one single design virtually anywhere in the world.



Speed up your projects

Challenge/trend An optimized manufacturing operation can provide that extra advantage needed to secure projects.

ABB answer ABB's factory accessorized products and easy-to-install accessories save up to 15% in installation and commissioning time.

Solar power

ABB has been a leading player in the solar power industry since the early 1990s

Since then, we have been involved at a pioneering stage in just about every type of photovoltaic (PV) and concentrating solar power (CSP) technology developed worldwide. This gave us a unique expertise in how best to harness, control and store solar energy and efficiently convert it into a reliable power source, ready for transfer into the local grid. ABB's portfolio of products, systems and solutions for the solar power industry is extensive. It ranges from complete power and automation solutions for utilities to commercial, industrial and residential rooftop photovoltaic installations.



DC

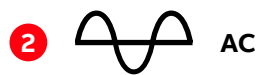

AC



Power collection



Grid connection



Furthermore, to check ABB capabilities and competences about PV applications, scan this QR code and download the Technical Application Paper "Photovoltaic plants".



Application overview

Residential system $\leq 20\text{kW}$ LV

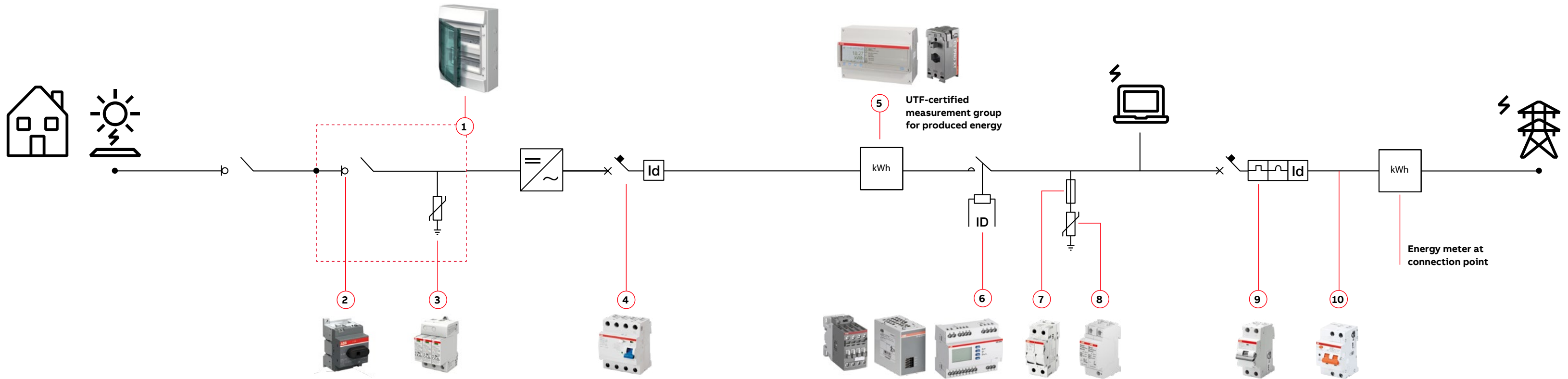

Low-voltage products:

- 1. String boxes
Switchboards: Gemini
Consumer units: MISTRAL65H
Circuit-Breakers: S200 M UC Z, S800 PV-SP
Fuse disconnectors: E 90 PV
Fuses: E 9F PV
- 2. Switch-disconnectors: OTDC, S800 PV-SD
- 3. Surge protection devices: OVR PV
- 4. Residual current devices: F202, F204
- 5. Energy meters: EQmeters and current transformers
- 6. Grid feeding monitoring relays: CM-UFD.MxxM
Contactors AC-3: AF Series
Power supplies and buffers: CP-C.1 e CP-B
- 7. Fuse disconnectors: E 90
- 8. Surge protective devices: OVR T1 / T1-T2 / T2 QS
- 9. Residual Current Circuit-Breakers: DS202C
- 10. Arc fault detection device (AFDD) with integrated residual current Circuit-Breaker with overcurrent protection (RCBO): DS-ARC1



DC

Protection and safety



MISTRAL65H

Strong, resistant and with a modern look, MISTRAL65H is the most innovative series of IP65 rated consumer units, designed to reduce cabling times as well as allow total integration between modular DIN-rail and front panel devices. Thanks to the elegant design, MISTRAL65H can be installed in residential environments where high level of IP protection is required.

For more information visit: [link](#)



E90 PV Fuse Holders and fuses

The E90 PV fuse holders have been specifically designed for photovoltaic applications. Thanks to their rated voltage up to 1500V DC, they are perfect for protection of strings in PV applications. Their compact size is perfect for installation in a string combiner box or in an inverter. E90 PV can be used in combination with E9F PV cylindrical fuses for 1000 or 1500V DC.

For more information visit: [link](#)



OVR PV

Surge Protective Devices are now well integrated in the solar system to protect DC and AC sides with the aim to provide continuity of service and reduce risk of fire, protecting from overvoltages due to lightning strikes or network disturbances. We designed the OVR PV to improve performance and protect any photovoltaic system according to IEC 61643-31 Standard.

For more information visit: [link](#)



High-performance string protection MCB S800PV-SP

The High-Performance MCB S800PV-SP, specially developed for photovoltaic systems, offers reliable protection for PV modules and lines against reverse currents from defective strings and AC regenerative feedback due to defective inverters. The high demands of PV systems have been considered a priority in the development of the S800PV-SP.

For more information visit: [link](#)



DC

Switch and disconnection



High-performance switch-disconnector MCB S800PV-SD

With highly compact design for installation on the DIN rail, the S800PV-SD switch-disconnector offers relevant safety isolation properties. As master switch for PV systems, the whole DC side can thus be safely isolated, locally or from remote.

For more information visit: [link](#)



High-performance polarized disconnecter MCB S800PV-M-H

This disconnecter might be small, but it's a giant when it comes to performance. With a nominal current range up to 100A, it covers a large range of applications. At the same time, the compact S802PV-M-H is only 54 mm wide. As a result, space requirement is minimal.

For more information visit: [link](#)



OTDC switches from 16 to 32 Amperes

High performance and energy efficiency: OTDC has very low power losses and is suitable for applications in high ambient temperatures. The rated currents need no derating even beyond 60°C (140 °F). Save installation space, time and cost: OTDC switches offer various DC voltage ratings up to 1000 V DC and a control of up to three circuits within the same footprint area. Three mounting options are available: door, base and DIN rail.

For more information visit: [link](#)



DC

Metering, monitoring and installation



CMS-660 - Solar string monitoring

How can you detect impairments such as leaves and dirt or even broken cables without great effort?

CMS-660 is a solar monitoring system that remotely checks the DC current produced by each string, allowing to compare it not only with its previous performance but also with the performance of other strings.

CMS allows detection of over-voltages, breaker trips or high temperatures.

For more information visit: [link](#)



Insulation monitoring relays

The insulation monitoring relays CM-IWM-10 and CM-IWM.11 guarantee a continuous insulation monitoring of an IT system. The devices recognize insulation faults as they develop and trip immediately if the value falls below the minimum set threshold.

This ensures a reliable operation of the system and prevents operational interruption caused by a second, more severe, insulation fault which may lead to a short-circuit trip of the main circuit-breaker.

For more information visit: [link](#)



Conduit & fittings

An electrical system is as reliable as its conductors and conduit systems & fittings, which provide unsurpassed protection and insulation for wires and cables in any demanding applications: power generation and solar panels.

For more information visit: [link](#)



Metal framing & support systems

ABB saves time and labor with its comprehensive lines of metal framing and cable tray, including the industry's only 100% plated products, our 1 1/2" modular system and hundreds of accessories to complete any job.

For more information visit: [link](#)



AC

Protection and safety



Residual current devices - RCDs

Residual current devices protect people from life-threatening indirect contacts according to IEC/EN 61008 or IEC/EN 61009 Standards. ABB offers a comprehensive range of devices like RCCBs, RCBOs, RCD-blocks, Earth Leakage Relays DIN-Rail and front panels in order to cope with all the applications in residential, commercial and industrial segments.

For more information visit: [link](#)



OVR QuickSafe®

QuickSafe is our new generation of Surge Protective Devices (SPD) with improved performance. Thanks to innovative technology this new range of SPDs covers residential and industrial applications with an extremely good protection level, simple installation and preventive maintenance. All according to IEC/EN 61643-11 Standard.

For more information visit: [link](#)



E90

Fuse switch-disconnectors

The E 90 fuse switch-disconnectors range for cylindrical fuses 8x31mm, 10x38mm, 14x51mm and 22x58mm, is specifically designed to provide protection against short-circuits and overloads. It is available in a complete range from 1 to 4 poles and provides disconnection properties according to IEC 60947-3 Standard.

For more information visit: [link](#)



DS-ARC1

A reliable protection against series and parallel arc faults, the DS-ARC1 arc fault detection devices offer an additional magnetothermic and differential protection. They can be supplied either top or bottom and are equipped with convenient functions like led monitoring, contact position indication, check button and autotest.

For more information visit: [link](#)



AC

Protection and safety



Miniature circuit-breakers - MCBs

Miniature circuit-breakers ensure electrical safety in multiple applications. They have two different tripping mechanisms, the delayed thermal tripping mechanism for overload protection and the magnetic tripping mechanism for short-circuit protection.

For more information visit: [link](#)



Molded case circuit-breakers

SACE Tmax XT

The SACE Tmax XT series of Molded Case Circuit-Breakers (MCCBs) are designed to maximize ease of use, integration and connectivity while reliably delivering safety and quality. Rather than just offering standalone protection, they are seen as key elements of the system that give you complete flexibility, extreme breaking capabilities and reliable performance under pressure.

For more information visit: [link](#)



AC

Switch and disconnection



Switch-disconnectors SD 200

SD 200 switch-disconnectors can be used as the main switch of the AC side of the inverters. The devices are mounted on a DIN rail or on the rear panel of a switchboard (depending on the rated current) and include a wide range of accessories, facilitating their use in various applications.

For more information visit: [link](#)



SACE Tmax XT switch-disconnectors

SACE Tmax XT switch-disconnectors are devices created from the corresponding circuit-breakers and feature the same overall dimensions and versions, and can be fitted with the same accessories.

For more information visit: [link](#)



EasyLine - XLP

fuse switch-disconnectors

EasyLine range of fuse switch-disconnectors ensures high protection and reliable operation in critical power applications, distribution boards, switchboards, capacitor banks.

For more information visit: [link](#)



AC

Switch and disconnection



Manual operated switch fuses

Our OS range includes manual operated switch fuses from 20 to 1250A, available for all types of fuses: DIN, BS, NFC, CC, JJ and L types.

For more information visit: [link](#)



Switch-disconnectors

16 to 4000A

Reliable in extreme conditions, ABB switch-disconnectors are designed, built and tested for the best possible performance. They are designed to be virtually maintenance-free across their entire extended lifespan and offer reliable performance in any circumstances. Durability has been ensured by testing switches against the IEC60947- 3, UL508, UL98 and CSA Standards.

For more information visit: [link](#)



AC

Metering, monitoring and installation



Energy Meters

Energy consumption awareness is key to reduce energy costs and improve energy efficiency on your machines and electrical assets. Energy meters allow to identify areas for improvement and to generate benefits for owners, facility managers and users. They enable to run smarter buildings in a more energy and cost efficient way.

For more information visit: [link](#)



Circuit Measurement Systems

With the rise of digitalization and the Internet of Things (IoT), data collection from the entire network for analysis becomes easier, enabling optimization of energy usage and assets. From monitoring energy consumption to control of operations and costs, connectivity-based solutions can improve energy efficiency while reducing costs.

For more information visit: [link](#)



Grid feeding monitoring relays CM-UFD

ABB's CM-UFD range are multi-functional grid feeding monitoring relays, installed between the renewable energy system and the public grid. They detect unusual events in the public power grid and automatically disconnect and reconnect the renewable power plant.

For more information visit: [link](#)



System pro E comfort MISTRAL

ABB's series of consumer units combine versatility and performance with an elegant design, reducing installation time while integrating several kinds of devices for DIN-rail and devices to be installed on mounting plate or on blind front panels. With the wide range of sizes and versions, ABB's consumer units are one of the most complete ranges on the market, providing a smarter space for all your installation ideas.

For more information visit: [link](#)



OTHER PRODUCTS



Ty-Rap high performance cable ties

Innovative design and engineered materials make Ty-Rap® cable ties the perfect fastening solution where performance really matters.

Often imitated but never equaled, Ty-Rap® cable ties provide superior performance in any application.

For more information visit: [link](#)



Wire termination & connectors

ABB is a recognized leader in providing electrical connectors suitable for the majority of all electrical applications.

For more information visit: [link](#)



External Lightning Protection - OPR

To provide effective protection, the Solar system must be protected against direct lightning strikes and have a proper grounding system in addition to protection against overvoltage on both sides of the inverter. OPR, ESE lightning rod is an active system that protects against direct lightning.

For more information visit: [link](#)



Kindorf Hold Down Clamps and Ty-rap cable edge solar clips

Easy and durable corrosive resistant solution for solar panel installation and wires and cables management. To be used with all brands of panels, different strut materials and all types of solar wires.

For more information visit: [link](#) and [link](#)

Application overview

Commercial system 20-1000 kW LV/MV

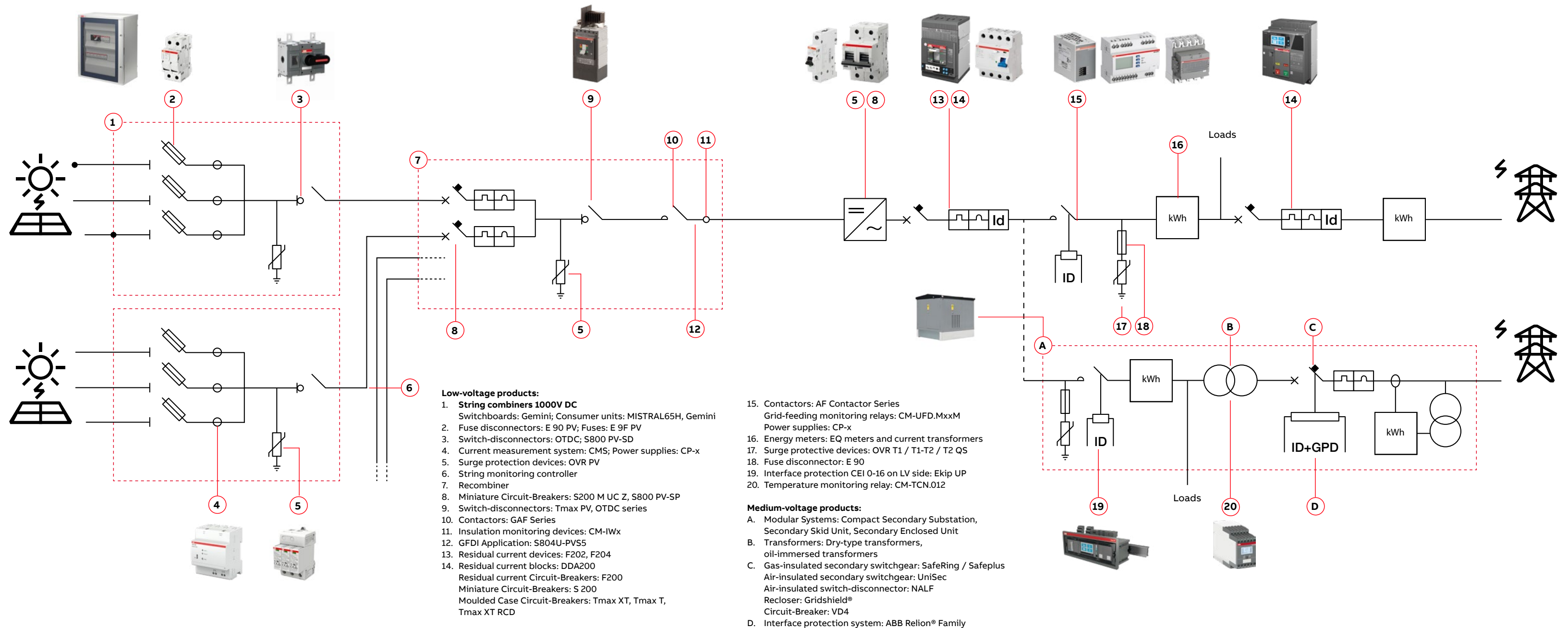



DC

Protection and safety



String combiner boxes GEMINI

In a photovoltaic system, the modules are arranged in strings and arrays depending on the type of inverter used, the total power and the technical characteristics of the modules. ABB offers a complete range of all-in-one combiner boxes hosting string protection devices, disconnectors and surge protective devices (SPDs). It is possible to add also monitoring devices.

For more information visit: [link](#)



E90 PV Fuse Holders and fuses

The E90 PV fuse holders have been specifically designed for photovoltaic applications. Thanks to their rated voltage up to 1500V DC, they are perfect for protection of strings in PV applications. Their compact size is optimal for installation in a string combiner box or in an inverter. E90 PV can be used in combination with E9F PV cylindrical fuses for 1000 or 1500V DC.

For more information visit: [link](#)



OVR PV

Surge Protective Devices are now well integrated in the solar system to protect DC and AC sides with the aim to provide continuity of service and reduce risk of fire, protecting from overvoltages due to lightning strikes or network disturbances. We designed the OVR PV to improve performance and protect any photovoltaic system according to IEC 61643-31 Standard.

For more information visit: [link](#)



High-performance string protection MCB S800PV-SP

The High-Performance MCB S800PV-SP, specially developed for photovoltaic systems, offers reliable protection for PV modules and lines against reverse currents from defective strings and AC regenerative feedback due to defective inverters. The high demands of PV systems have been considered a priority in the development of the S800PV-SP.

For more information visit: [link](#)



DC

Switch and disconnection



SACE Tmax T - PV

The SACE Tmax PV range of molded-case circuit-breakers and switch-disconnectors for IEC and UL applications on both the DC and AC sides of a photovoltaic plant, expands the widely appreciated ability of the SACE Tmax T range to provide the most adaptable and versatile solution for every type of application. The aim is to enhance energy efficiency and limit the rated currents involved, thereby reducing switchgear size, installation time and costs.

For more information visit: [link](#)



DC switch-disconnectors 16...1600 A

The OTDC range of switch-disconnectors from 16 to 1600A is specially designed for DC applications. Thanks to compact design, efficiency and reliability, they bring PV installations to the next level. The versatile OTDC portfolio includes solutions for installations with the most special requirements: 1500 V DC voltages, multi-circuit switching and combined load outputs up to 1600 A.

For more information visit: [link](#)



High-performance switch-disconnector MCB S800PV-SD

With highly compact design for installation on the DIN rail, the S800PV-SD switch-disconnector offers relevant safety isolation properties. As master switch for PV systems, the whole DC side can thus be safely isolated, locally or from remote.

For more information visit: [link](#)



DC

Metering, monitoring and installation



CMS-660 - Solar string monitoring

How can you detect impairments such as leaves and dirt or even broken cables without great effort?

CMS-660 is a solar monitoring system that remotely checks the DC current produced by each string, allowing to compare it not only with its previous performance but also with the performance of other strings.

CMS allows detection of over-voltages, breaker trips or high temperatures.

For more information visit: [link](#)



Insulation monitoring relays

The insulation monitoring relays CM-IWM-10 and CM-IWM.11 guarantee a continuous insulation monitoring of an IT system. The devices recognize insulation faults as they develop and trip immediately if the value falls below the minimum set threshold.

This ensures a reliable operation of the system and prevents operational interruption caused by a second, more severe, insulation fault which may lead to a short-circuit trip of the main circuit-breaker.

For more information visit: [link](#)



Conduit & fittings

An electrical system is as reliable as its conductors and conduit systems & fittings, which provide unsurpassed protection and insulation for wires and cables in any demanding applications: power generation and solar panels.

For more information visit: [link](#)



Metal framing & support systems

ABB saves time and labor with its comprehensive lines of metal framing and cable tray, including the industry's only 100% plated products, our 1 1/2" modular system and hundreds of accessories to complete any job.

For more information visit: [link](#)



AC

Protection and safety



OVR QuickSafe®

QuickSafe is our new generation of Surge Protective Devices (SPD) with improved performance. Thanks to innovative technology this new range of SPDs covers residential and industrial applications with an extremely good protection level, simple installation and preventive maintenance. All according to IEC/EN 61643-11 Standard.

For more information visit: [link](#)



E90 50A/125A

Fuse switch-disconnectors

The E 90 50A/125A fuse switch-disconnectors range for cylindrical fuses 14x51mm and 22x58mm, is specifically designed to provide protection against short-circuits and overloads. It is available in a complete range from 1 to 4 poles and provides disconnection properties according to IEC 60947-3 Standard.

For more information visit: [link](#)



Miniature circuit-breakers - MCBs

Miniature circuit-breakers ensure electrical safety in multiple applications. They have two different tripping mechanisms, the delayed thermal tripping mechanism for overload protection and the magnetic tripping mechanism for short-circuit protection.

For more information visit: [link](#)



Residual current devices - RCDs

Residual current devices protect people from life-threatening indirect contacts according to IEC/EN 61008 or IEC/EN 61009 Standards. ABB offers a comprehensive range of devices like RCCBs, RCBOs, RCD-blocks, Earth Leakage Relays DIN-Rail and front panels in order to cope with all the applications in residential, commercial and industrial segments.

For more information visit: [link](#)



AC

Protection and safety



Molded case circuit-breakers

SACE Tmax XT

The SACE Tmax XT series of Molded Case Circuit-Breakers (MCCBs) are designed to maximize ease of use, integration and connectivity while reliably delivering safety and quality. Rather than just offering standalone protection, they are seen as key elements of the system that give you complete flexibility, extreme breaking capabilities and reliable performance under pressure.

For more information visit: [link](#)



SACE Emax 2

SACE Emax 2 all-in-one is the first circuit-breaker that matches new grid requirements. It enables a direct communication to the new energy management cloud-computing platform ABB Ability™ Electrical Distribution Control System. Smart and plug and play architecture makes Emax 2 all-in-one easy to use. Leveraging also unmatched electrical performances, Emax 2 sets a new circuit-breaker benchmark for the needs of today and tomorrow.

For more information visit: [link](#)



Ekip UP

Ekip UP is a digital unit that can perform different functions. Thanks to its 5 versions, it solves needs ranging from measurement to protection, up to automatic logics. In addition, it is IEC 60255 certified. Ekip UP can monitor the energy consumption of commercial buildings by connecting directly to the cloud for remote monitoring. Ekip UP can protect distribution and generation within an industrial plant by directly controlling switches. Ekip UP offers pre-programmed switching logics without the use of PLCs. Ekip UP offers advanced protections for entire urban micro-grids or islanded microgrids, facilitating the exchange from various energy sources, from solar inverters to diesel generators.

For more information visit: [link](#)



AC

Protection and switch



Switches

The switch family consists of a complete range of switch-disconnectors, switch fuses, change-over switches, automatic transfer switches, bypass switches, cam switches and fuses. ABB's switches are designed for flexibility and reliable performance in a wide variety of applications: power distribution for residential and industrial buildings, HVAC, water pumping stations, data centers and photovoltaic installations.

For more information visit: [link](#)



InLine II - Fuse switch-disconnectors

InLine II is a technically reliable and proven solution for demanding conditions. A wide range of devices with 800-1000V AC ratings up to 120kA is available to support the higher voltage architectures in solar power plants. With a wide range of accessories and cable terminal connections, InLine II guarantees the highest amount of safety and stability.

For voltages up to 880V AC, an Electronic Fuse Monitoring is available as accessory.

For more information visit: [link](#)



SACE Tmax T4V-HA, T5V-HA and T5X-HA

SACE Tmax PV can be used in plants with voltage up to 800V AC and do not require derating in voltages and breaking capacity up to 4000m. SACE Tmax PV T4V-HA, T5X-HA and T5V-HA circuit-breakers for AC applications are available in UL, IEC 60947-2 and GB14048.2 versions. The T4V-HA bearing the three UL, IEC and CCC marks and T5V-HA bearing both the IEC and UL marks, while T5X-HA fulfils the UL 489 requirements.

For more information visit: [link](#)



AC

Switch and disconnection



SlimLine XRG

SlimLine XRG range offer exceptional energy efficiency, reducing the increase in temperature and thus increasing performance inside the switchboard. Thanks to the plug in contacts, installation is quick and easy. The advanced ITS2 management and measurement module facilitates the connection to control systems and remote monitoring.

For more information visit: [link](#)



AF contactors

AF contactors with standard AF technology define a new benchmark. The electronically controlled coil offers numerous advantages over competitors, optimized logistics and lower management costs thanks to few product variations. The 80% reduction in the coil electrical consumption allows energy savings. AF technology allows you to overcome drops and falls of voltage. Main features: up to 1000 A, 690 V AC-1 and 540 A, 600 V for general use, integrated overvoltage charger and mirror contacts mechanically connected.

For more information visit: [link](#)



AC

Grid connection (Low Voltage)



Temperature monitoring relays

The temperature monitoring relay CM-TCN measures temperatures of solids, liquids and gaseous media within up to three sensor circuits using different types of sensors, such as PT100, PT1000, PTC or NTC at the same time. The device allows different thresholds and has three output relays. Easy to configure thanks to predefined settings for key applications and Epic mobile App. Thanks to Modbus RTU can easily communicate with supervisors.

For more information visit: [link](#)



Grid feeding monitoring relays CM-UFD

ABB's CM-UFD range are multi-functional grid feeding monitoring relays, installed between the renewable energy system and the public grid. They detect unusual events in the public power grid and automatically disconnect and reconnect the renewable power plant.

For more information visit: [link](#)



Ekip UP CEI 0-16 (Interface Protection System)

Ekip UP performs the functions of SPI relay for the active systems connected to the MV distribution network. Complying to CEI 0-16 Standard aligned with the European Standards EU 2016/631, EU 2016/1388 and EU 2016/1447. Among its 35 protections, the one for restricted ground fault REF (ANSI 87) can command circuit-breakers both by wired signal and with advanced native communication protocols such as IEC 61850.

For more information visit: [link](#)



UPS PowerValue 11T G2 CEI - 016

UPS PowerValue 11T G2 CEI - 016 is a single-phase, double conversion uninterruptible power supply (VFI) which guarantees up to 3 kW for applications in MV / LV transformer substations compliant with CEI-016. The UPS guarantees continuity for a period of 60 minutes maintaining a power reserve, starting from the battery, useful for resetting the interface protection system (SPI) and subsequent closing of the main switch.

For more information visit: [link](#)



AC

Metering, monitoring and installation



Energy Meters

Energy consumption awareness is key to reduce energy costs and improve energy efficiency on your machines and electrical assets.

Energy meters allow to identify areas for improvement and to generate benefits for owners, facility managers and users. They enable to run smarter buildings in a more energy and cost efficient way.

For more information visit: [link](#)



Circuit Monitoring Systems

With the rise of digitalization and the Internet of Things (IoT), data collection from the entire network for analysis becomes easier, enabling optimization of energy usage and assets.

From monitoring energy consumption to control of operations and costs, connectivity-based solutions can improve energy efficiency while reducing costs.

For more information visit: [link](#)



M4M

M4M is a stand-alone network analyzer that responds to all the monitoring needs of the energy distribution system: from the high-precision monitoring of the electrical parameters of energy efficiency to the complete analysis of the energy quality using advanced KPIs. Thanks to the connectivity features, M4M can take advantage of the integration of scalable energy and asset management in ABB solutions to monitor, optimize and control the entire electrical system.

For more information visit: [link](#)



ABB Ability™ Energy and Asset Manager (EAM)

EAM is the innovative cloud management platform developed to monitor, optimize and manage electrical systems. Among the main features, multisite management, real-time alerts via email and sms, report of the stored values, digital twin of the system, predictive maintenance functions, support to ISO 50001.

For more information visit: [link](#)



AC

Consumer units, enclosures and low voltage switchboards



Gemini multipurpose enclosures

Gemini switchboards are made through co-injection technology and ABB is the first manufacturer to use it as a molding technique. This process obtains a compact external hard covering and an expanded internal soft core, guaranteeing the highest level of mechanical protection against impacts (IK10). Gemini keeps its mechanical characteristics in the long term.

For more information visit: [link](#)



ARIA

Universal polyester enclosures IP66, IK10, UL, CSA and Lloyd's Register certified. 7 sizes from 315 x 215 x 170 mm up to 1035 x 835 x 300 mm. Self-extinguishing and halogen-free. Corrosion resistant and requires no maintenance.

For more information visit: [link](#)



Polysafe

Polyfunctional enclosures in polyester IP65 / IP54, IK10, UL and CSA certified. 14 standard sizes, from 500 x 500 mm up to 1250 x 1000 mm, combinable with each other and with a 320 mm depth extendable to 640 mm. Factory assembled (empty or equipped).

For more information visit: [link](#)



System pro E power

System pro E power is an innovative solution for main distribution boards with rated current up to 6300A and short-circuit current up to 120kA. Designed to easily respond to all electrical installation requirements in terms of degree of protection, form of segregation and electrical characteristics, according to the latest international Standards and in perfect synergy with all ABB low voltage equipment.

For more information visit: [link](#)



POWER COLLECTION / GRID CONNECTION



Unipack CSS

Safe working:

- Internal arc fault and type tested (IEC 62271-202)
- Connected to SCADA
- ABB Ability™ enabled for maintenance and remote management

Optimized life cycle and maintenance cost:

- Corrosion resistant enclosure of Glass Reinforced Polyester

Fast installation, commissioning and relocation:

- Lightweight and factory assembled
- Flexible with wide range of ratings

For more information visit: [link](#)



EcoFlex eHouse

Modular, factory assembled and tested, with ISO dimensions:

- Combinable modules
- Seismic rated
- C5M Coating

Risk mitigation, improved lead time and reduced overall cost:

- Minimal site works
- Factory production

Transportable, configurable and standardized:

- Configurable: electrical equipment, floor/wall material, module combinations
- Reduced engineering
- Standard shipping

For more information visit: [link](#)



Secondary Skid Unit

- Pre-configured design solutions
- Factory assembled and routine tested
- One piece delivery for minimizing site works
- Efficient cooling based on an open air design with no additional HVAC required
- No exposed live parts
- ABB Ability™ digitally enabled solution providing predictive maintenance and remote management

For more information visit: [link](#)



POWER COLLECTION / GRID CONNECTION



Air-insulated secondary switchgear UniSec

UniSec is suitable for up to 24 kV, 1250A, 25kA. It offers a broad portfolio of functional units and technical features. It's suitable for a wide range of applications including solar, industry, substations, data centers and smart grids. Also available as ABB Ability™ UniSec Digital.

For more information visit: [link](#)



Gas-insulated secondary switchgear SafeRing/SafePlus

Compact metal enclosed switchgear for up to 40.5 kV. Unique flexibility thanks to extendibility and the combination of fully modular and semi-modular configurations. High level of reliability, safety and a virtually maintenance-free system. Also available with AirPlus™ or Dry Air insulation gases.

For more information visit: [link](#)



ecoGIS SF6 free Gas-insulated switchgear

ABB has been developing and deploying alternatives to the greenhouse gas sulfur hexafluoride (SF6) on the path towards greater eco-efficiency and lower environmental impact. ABB can offer medium-voltage switchgear Dry Air insulation up to 12kV and above 12kV with AirPlus™ a groundbreaking eco-efficient gas mixture with 99.99% lower global warming potential (GWP). ecoGIS AirPlus™ with a global warming potential (GWP) < 1, it is the world's first MV SF6 free GIS up to 40,5kV which keeps compact switchgear dimensions and all GIS advantages. AirPlus technology is introduced stepwise to the ZX and SafeRing/SafePlus product families – ABB's primary and secondary distribution GIS.

Benefits of AirPlus switchgear:

- Eco-efficient with a GWP < 1
- ABB has the most complete SF6-free portfolio on the market, with ratings from 12 to 40.5 kV.
- Same compactness as equivalent SF6 GIS portfolio
- Low pressure design assure safety and service availability in case of loss of pressure
- Retains advantages of established GIS technology
- Avoids SF6 regulations
- Used in reliable and proven switchgear products

For more information visit: [link](#)



OTHER PRODUCTS



Metal framing & support systems

ABB saves time and labor with its comprehensive lines of metal framing and cable tray, including the industry's only 100% plated products, our 1 1/2" modular system and hundreds of accessories to complete any job.

For more information visit: [link](#)



Cable protection and insulation

ABB offers a wide range of products to guide, protect and insulate your wires and cables in your control panels and equipment. Our range includes braided sleeving, extruded grommeting, heatshrink and spiral wrap.

For more information visit: [link](#)



External Lightning Protection - OPR

To provide effective protection, the Solar system must be protected against direct lightning strikes and have a proper grounding system in addition to protection against overvoltage on both sides of the inverter. OPR, ESE lightning rod is an active system that protects against direct lightning.

For more information visit: [link](#)



Blackburn grounding systems

Blackburn compression, mechanical and exothermic connectors and accessories represent the most comprehensive set of products in the industry for the creation of a safe, code compliant and reliable grounding system.

For more information visit: [link](#)

Application overview

Utility scale system > 1 MW MV/HV - CENTRAL INVERTERS - Low-voltage products

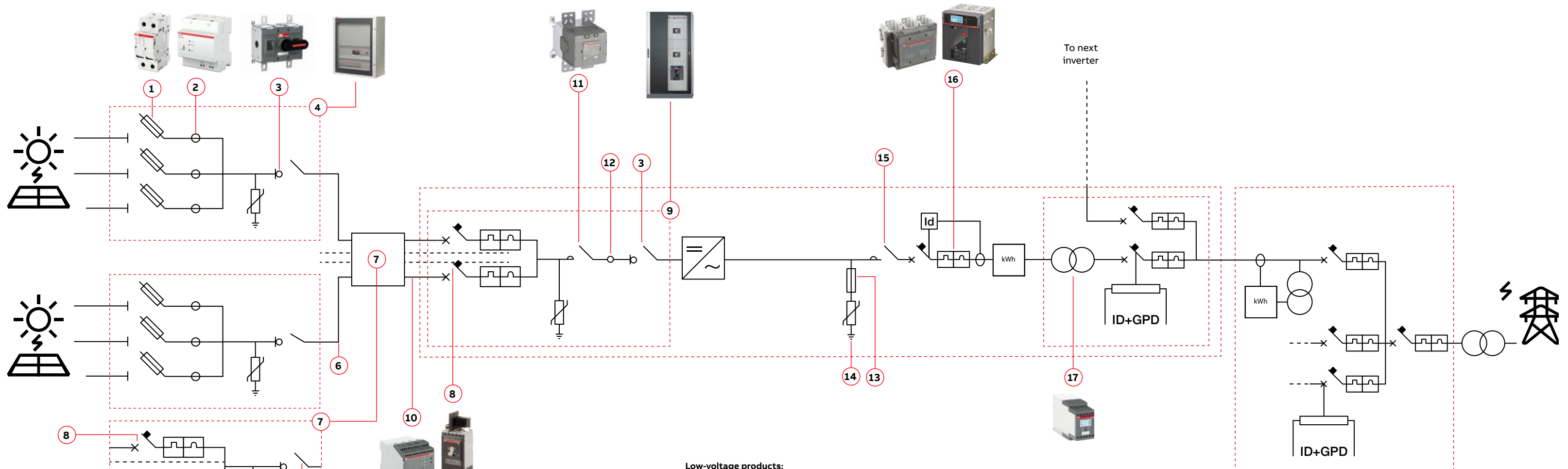

Low-voltage products:

- 1. Fuse disconnectors: E 90 PV; Fuses: E 9F PV
- 2. Current measurement system: CMS
- 3. Switch-disconnectors: OTDC
- 4. **String combiners: 1000V DC/1500V DC**
Switchboards: Gemini, Aria and Polysafe
- 5. Surge Protection Devices: OVR PV
- 6. String Monitoring Controller
- 7. Recombiner
- 8. Moulded Case Circuit-Breakers: Tmax PV
- 9. DC switchboards: System pro E power

- 10. Insulation monitoring devices: CM-IWx
- 11. Contactors: GF and GAF series
- 12. GFDI Application: S804U-PV55
- 13. Fuse disconnectors: E 90
- 14. Surge protection devices: OVR T1 / T1-T2 / T2 QS
- 15. Contactors: AF Series
- 16. Moulded Case Circuit-Breakers: Tmax XT, Tmax T
Air Circuit-Breakers: Emax 2
- 17. Temperature monitoring relay: CM-TCN.012

Application overview

Utility scale system > 1 MW MV/HV - CENTRAL INVERTERS - Medium-voltage products

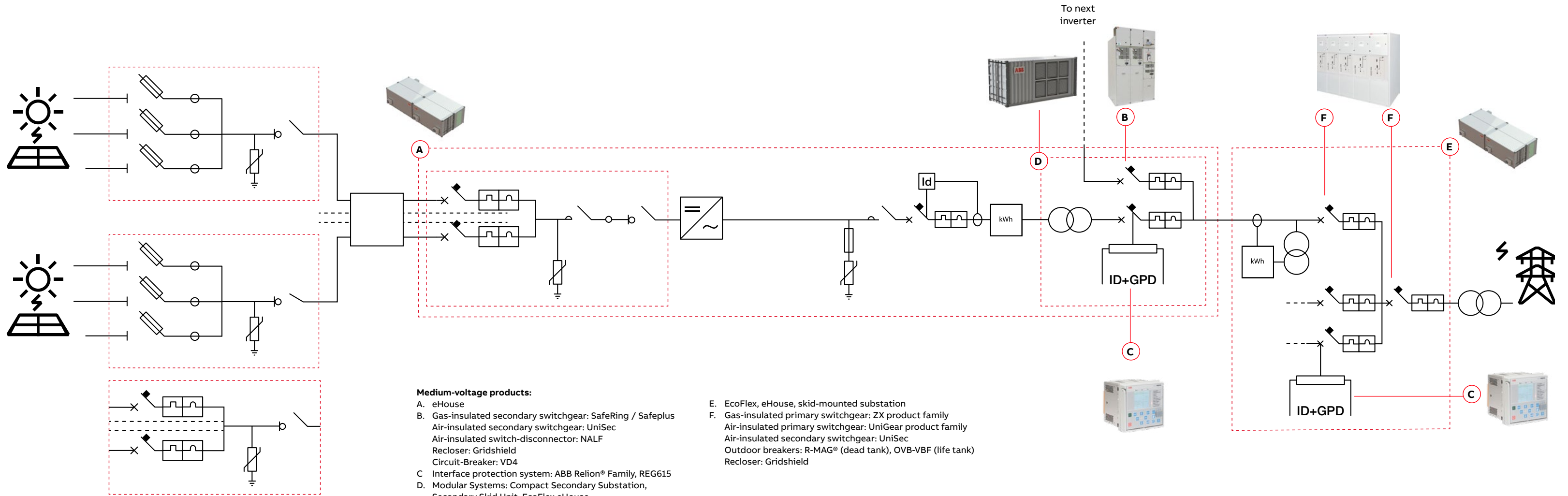

Application overview

Utility scale system > 1 MW MV/HV - STRING INVERTERS - Low-voltage products

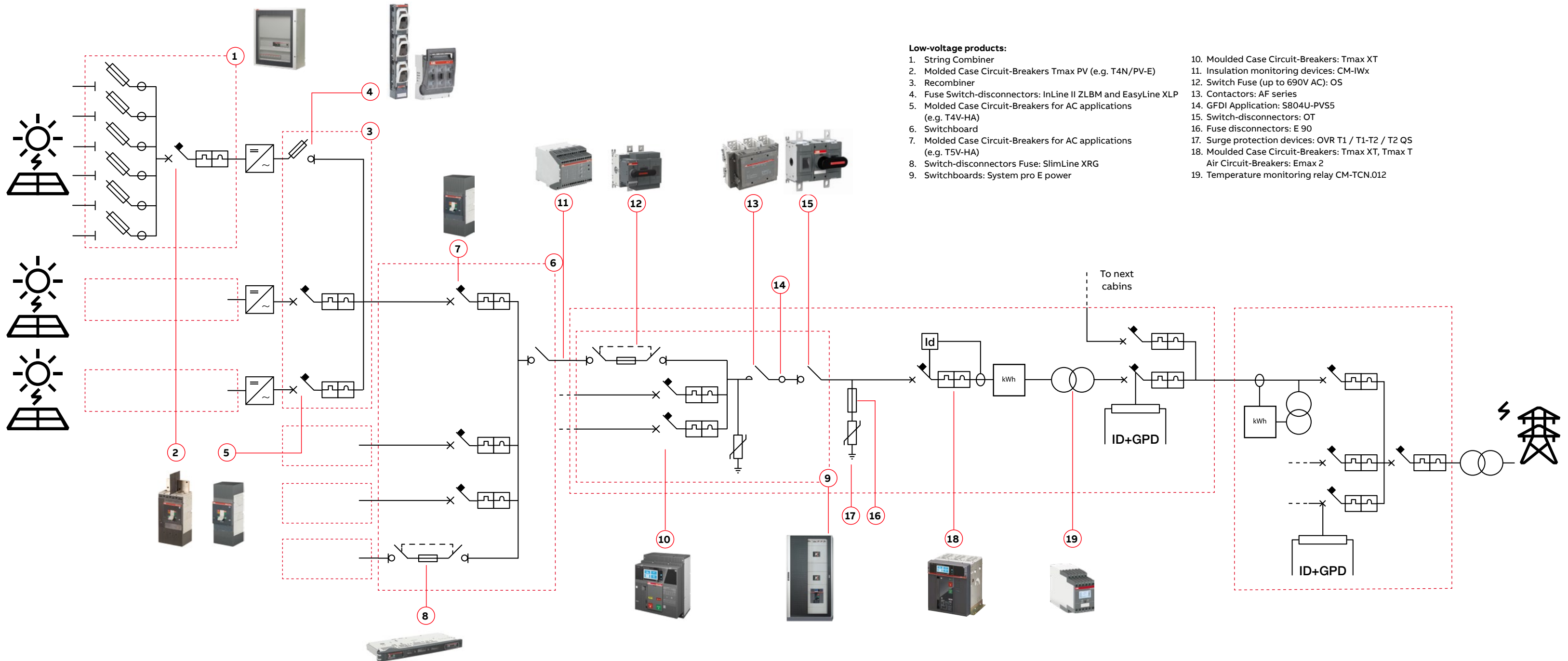

Application overview

Utility scale system > 1 MW MV/HV - STRING INVERTERS - Medium-voltage products

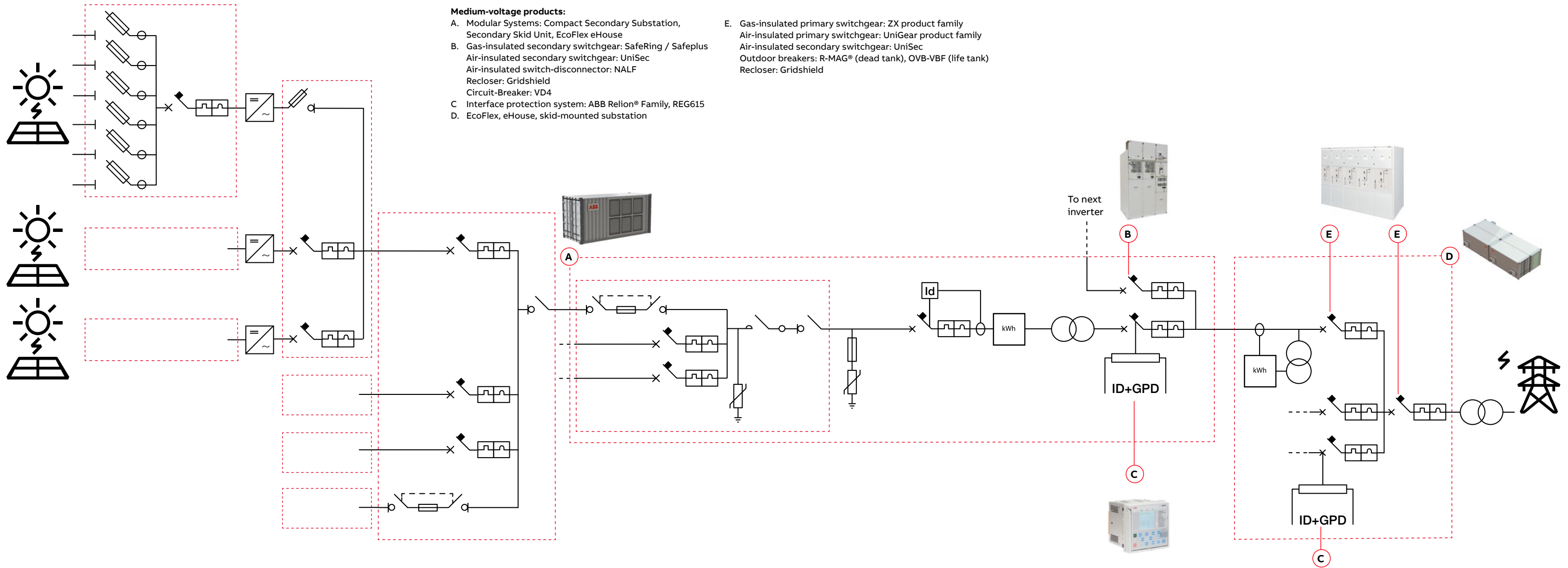

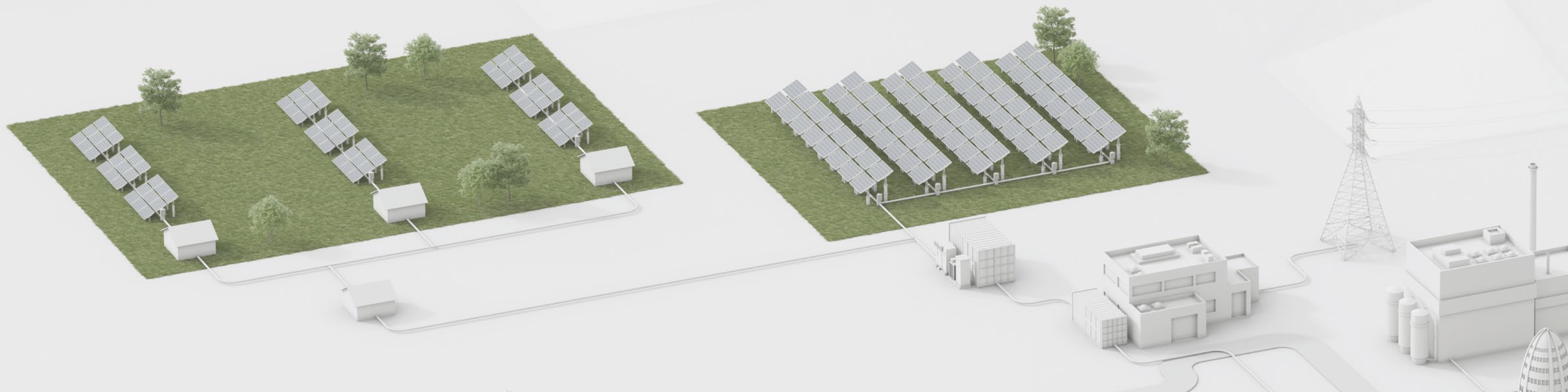

DC

Protection and safety



String combiner boxes GEMINI

In a photovoltaic system, the modules are arranged in strings and arrays depending on the type of inverter used, the total power and the technical characteristics of the modules. ABB offers a complete range of all-in-one combiner boxes hosting string protection devices, disconnectors and surge protective devices (SPDs). It is possible to add also monitoring devices.

For more information visit: [link](#)



E90 PV Fuse Holders and fuses

The E90 PV fuse holders have been specifically designed for photovoltaic applications. Thanks to their rated voltage up to 1500V DC, they are perfect for protection of strings in PV applications. Their compact size is optimal for installation in a string combiner box or in an inverter. E90 PV can be used in combination with E9F PV cylindrical fuses for 1000 or 1500V DC.

For more information visit: [link](#)



OVR PV

Surge Protective Devices are now well integrated in the solar system to protect DC and AC sides with the aim to provide continuity of service and reduce risk of fire, protecting from overvoltages due to lightning strikes or network disturbances. We designed the OVR PV to improve performance and protect any photovoltaic system according to IEC 61643-31 Standard.

For more information visit: [link](#)



S800PV Ground Fault Detector Interrupter

S800PV is used for GFDI application (Ground-Fault Detector Interrupter) in photovoltaic systems. The S804PV-SP5, S804U-PVS5 and S804U-PVSP5 provide ground fault protection according to IEC60947-2 for 1500 VDC, UL489B for 1000 VDC and UL489B (recognized) for 1500 VDC. In case of a ground fault, the breaker will trip, so that the PV generator will not be damaged.

For more information visit: [link](#)

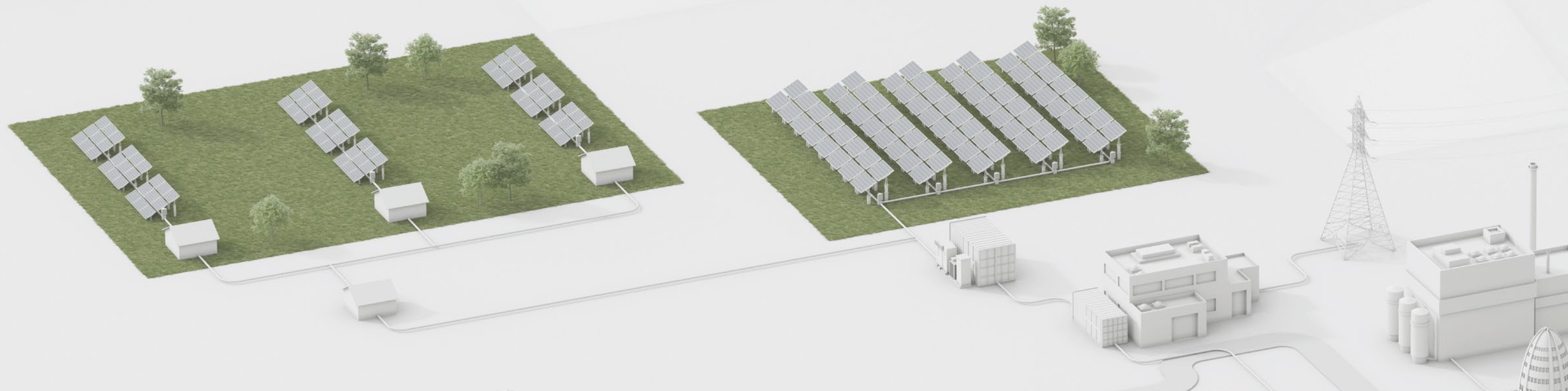

DC

Switch and disconnection



DC switch-disconnectors 16...1600 A

The OTDC range of switch-disconnectors from 16 to 1600A is specially designed for DC applications. Thanks to compact design, efficiency and reliability, they bring PV installations to the next level. The versatile OTDC portfolio includes solutions for installations with the most special requirements: 1500 V DC voltages, multi-circuit switching and combined load outputs up to 1600 A.

For more information visit: [link](#)



SACE Tmax T - PV

The SACE Tmax PV range of molded-case circuit-breakers and switch-disconnectors for IEC and UL applications on both the DC and AC sides of a photovoltaic plant, expands the widely appreciated ability of the SACE Tmax T range to provide the most adaptable and versatile solution for every type of application. The aim is to enhance energy efficiency and limit the rated currents involved, thereby reducing switchgear size, installation time and costs.

For more information visit: [link](#)



GF contactor

Dedicated contactor for PV solar applications. First ever contactor for new IEC utilization category DC-PV3. Gf contactors range enables automatic, remote and efficient DC switching for 1500V DC solar applications. Bringing energy efficiency, continuous operation and reduced project time to central PV inverter manufacturers.

Standards: IEC/UL

Rated operational voltage U_e max: 1500V DC

Rated current 1500V DC-PV3: 875...1050A

For more information visit: [link](#)

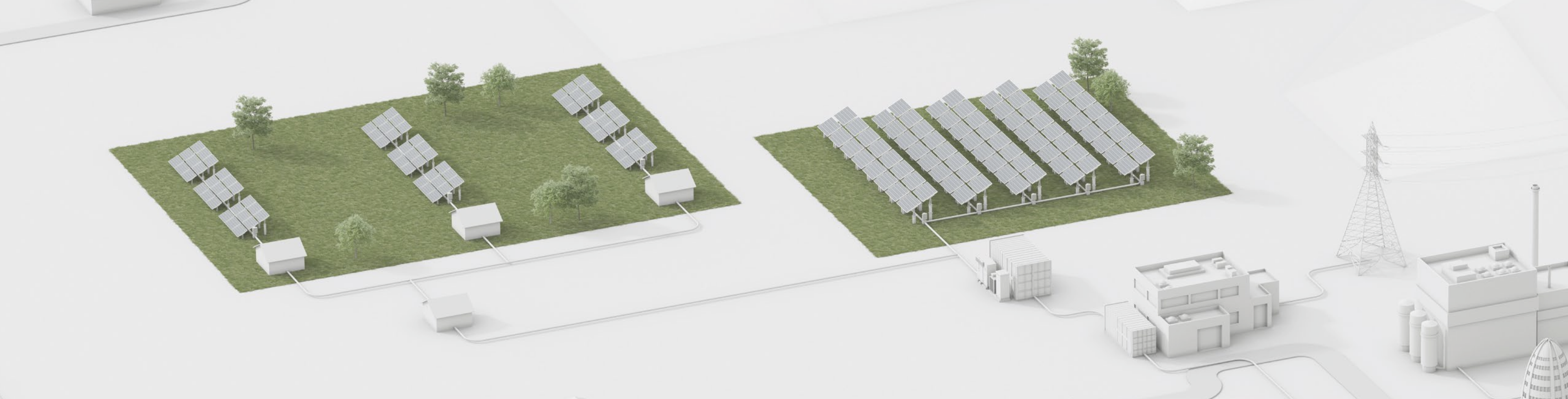

DC

Metering, monitoring and installation



CMS-660 - Solar string monitoring

How can you detect impairments such as leaves and dirt or even broken cables without great effort?

CMS-660 is a solar monitoring system that remotely checks the DC current produced by each string, allowing to compare it not only with its previous performance but also with the performance of other strings.

CMS allows detection of over-voltages, breaker trips or high temperatures.

For more information visit: [link](#)



Insulation monitoring relays

The insulation monitoring relays CM-IWM-10 and CM-IWM.11 guarantee a continuous insulation monitoring of an IT system. The devices recognize insulation faults as they develop and trip immediately if the value falls below the minimum set threshold.

This ensures a reliable operation of the system and prevents operational interruption caused by a second, more severe, insulation fault which may lead to a short-circuit trip of the main circuit-breaker.

For more information visit: [link](#)



Conduit & fittings

An electrical system is as reliable as its conductors and conduit systems & fittings, which provide unsurpassed protection and insulation for wires and cables in any demanding applications: power generation and solar panels.

For more information visit: [link](#)



Metal framing & support systems

ABB saves time and labor with its comprehensive lines of metal framing and cable tray, including the industry's only 100% plated products, our 1 1/2" modular system and hundreds of accessories to complete any job.

For more information visit: [link](#)

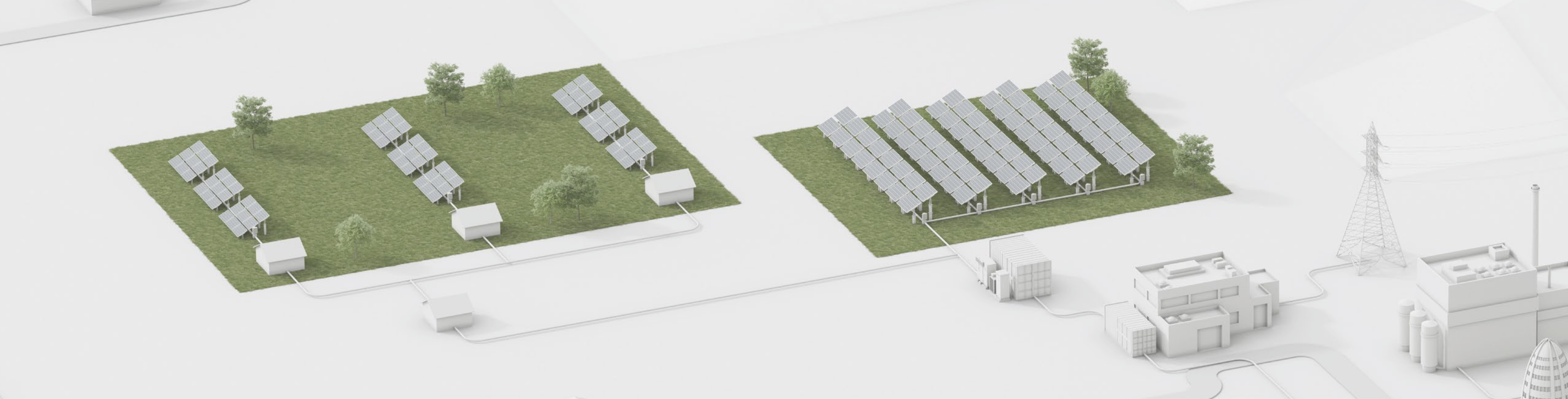

AC

Protection and safety



Residual current devices - RCDs

Residual current devices protect people from life-threatening indirect contacts according to IEC/EN 61008 or IEC/EN 61009 Standards. ABB offers a comprehensive range of devices like RCCBs, RCBOs, RCD-blocks, Earth Leakage Relays DIN-Rail and front panels in order to cope with all the applications in residential, commercial and industrial segments.

For more information visit: [link](#)



OVR QuickSafe®

QuickSafe is our new generation of Surge Protective Devices (SPD) with improved performance. Thanks to innovative technology this new range of SPDs covers residential and industrial applications with an extremely good protection level, simple installation and preventive maintenance. All according to IEC/EN 61643-11 Standard.

For more information visit: [link](#)



SACE Emax 2/E9

- Smart, plug-and-play architecture, easy to use
- The best performance up to 900V of any device on the market
- The first smart circuit-breaker that enables direct communication with ABB Ability™ Energy and Asset Manager
- Emax 2/E9 all-in-one is the most compact circuit-breaker on the market

For more information visit: [link](#)



SACE Tmax T4V-HA, T5V-HA and T5X-HA

SACE Tmax PV can be used in plants with voltage up to 800V AC and do not require derating in voltages and breaking capacity up to 4000m. SACE Tmax PV T4V-HA, T5X-HA and T5V-HA circuit-breakers for AC applications are available in UL, IEC 60947-2 and GB14048.2 versions. The T4V-HA bearing the three UL, IEC and CCC marks and T5V-HA bearing both the IEC and UL marks, while T5X-HA fulfils the UL 489 requirements

For more information visit: [link](#)

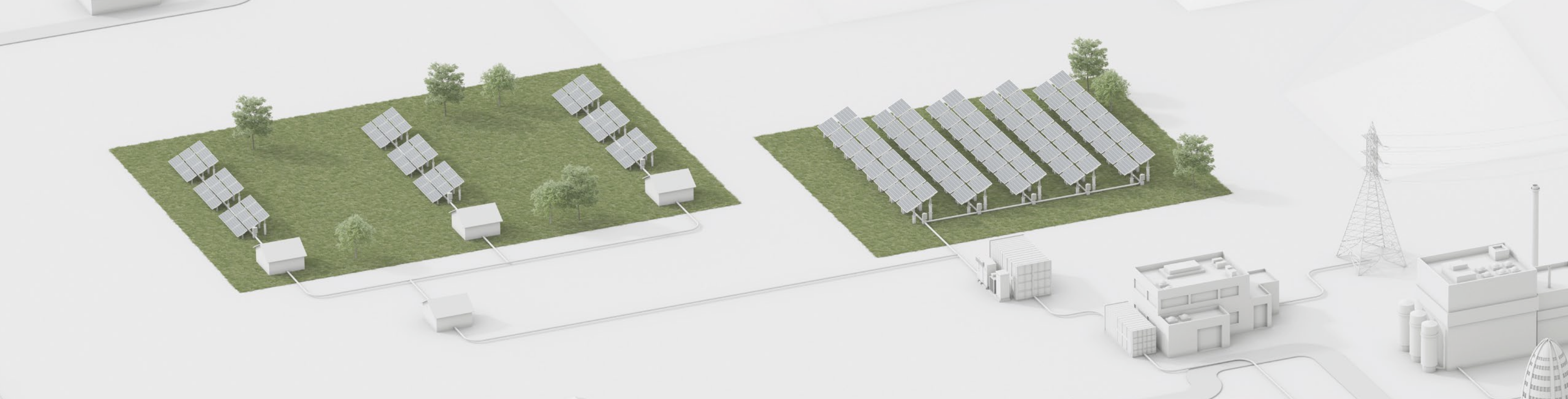

AC

Switch and disconnection



Switches

The switch family consists of a complete range of switch-disconnectors, switch fuses, change-over switches, automatic transfer switches, bypass switches, cam switches and fuses.

ABB's switches are designed for flexibility and reliable performance in a wide variety of applications: power distribution for residential and industrial buildings, HVAC, water pumping stations, data centers and photovoltaic installations.

For more information visit: [link](#)



Fuse switch-disconnectors

InLine II, EasyLine XLP and SlimLine XRG are a technically reliable and proven solution for demanding conditions. A wide range of devices with 800 -1000V AC ratings up to 120kA are available to support the highest voltage architectures in solar power plants. With a wide range of accessories and cable terminal connections, they guarantee the highest amount of safety and stability. For voltages up to 880V AC, an Electronic Fuse Monitoring is available as accessory.

For more information visit: [link](#)

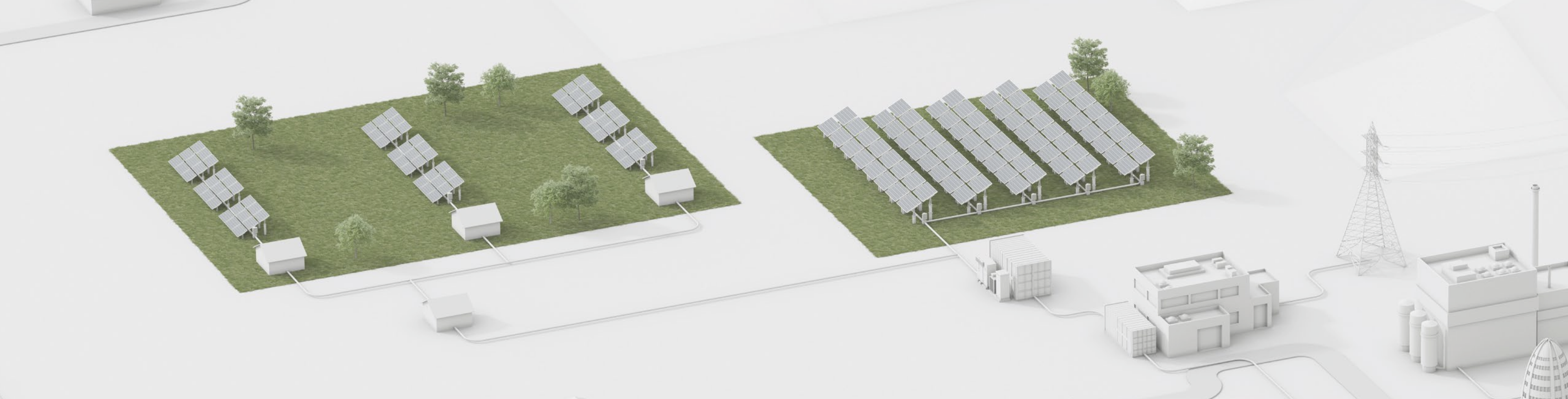

AC

Grid connection (Low Voltage)



Temperature monitoring relays

The temperature monitoring relay CM-TCN measures temperatures of solids, liquids and gaseous media within up to three sensor circuits using different types of sensors, such as PT100, PT1000, PTC or NTC at the same time. The device allows different thresholds and has three output relays. Easy to configure thanks to predefined settings for key applications and Epic mobile App. Thanks to Modbus RTU can easily communicate with supervisors.

For more information visit: [link](#)



Grid feeding monitoring relays CM-UFD

ABB's CM-UFD range are multi-functional grid feeding monitoring relays, installed between the renewable energy system and the public grid. They detect unusual events in the public power grid and automatically disconnect and reconnect the renewable power plant.

For more information visit: [link](#)



Ekip UP CEI 0-16 (Interface Protection System)

Ekip UP performs the functions of SPI relay for the active systems connected to the MV distribution network. Complying to CEI 0-16 Standard aligned with the European Standards EU 2016/631, EU 2016/1388 and EU 2016/1447. Among its 35 protections, the one for restricted ground fault REF (ANSI 87) can command circuit-breakers both by wired signal and with advanced native communication protocols such as IEC 61850.

For more information visit: [link](#)



UPS PowerValue 11T G2 CEI - 016

UPS PowerValue 11T G2 CEI - 016 is a single-phase, double conversion uninterruptible power supply (VFI) which guarantees up to 3 kW for applications in MV / LV transformer substations compliant with CEI-016. The UPS guarantees continuity for a period of 60 minutes maintaining a power reserve, starting from the battery, useful for resetting the interface protection system (SPI) and subsequent closing of the main switch.

For more information visit: [link](#)

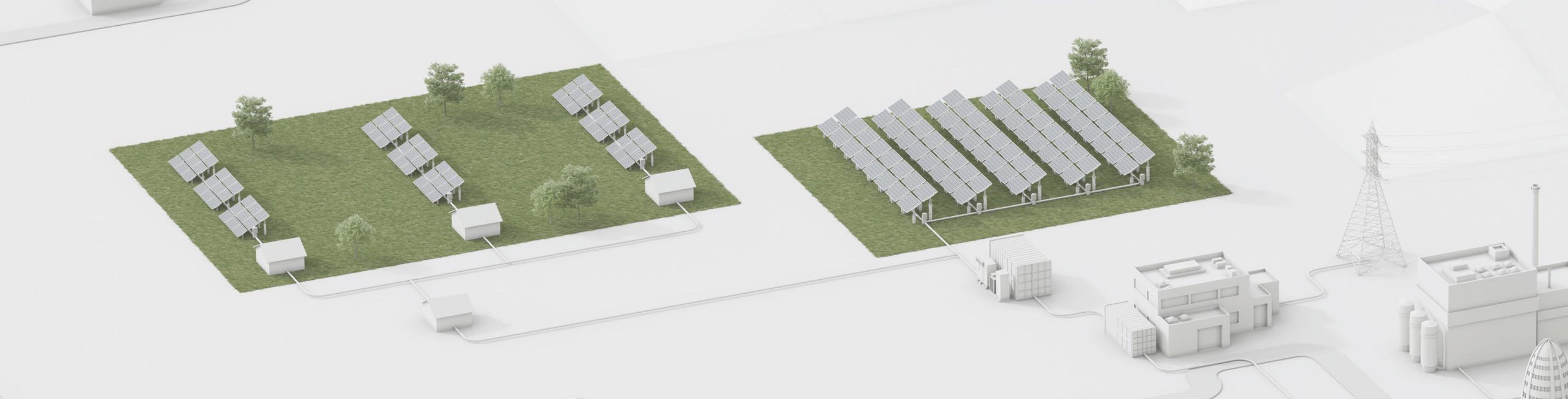

AC

Metering, monitoring and installation



Energy Meters

Energy consumption awareness is key to reduce energy costs and improve energy efficiency on your machines and electrical assets.

Energy meters allow to identify areas for improvement and to generate benefits for owners, facility managers and users. They enable to run smarter buildings in a more energy and cost efficient way.

For more information visit: [link](#)



Circuit Monitoring Systems

With the rise of digitalization and the Internet of Things (IoT), data collection from the entire network for analysis becomes easier, enabling optimization of energy usage and assets.

From monitoring energy consumption to control of operations and costs, connectivity-based solutions can improve energy efficiency while reducing costs.

For more information visit: [link](#)



M4M

M4M is a stand-alone network analyzer that responds to all the monitoring needs of the energy distribution system: from the high-precision monitoring of the electrical parameters of energy efficiency to the complete analysis of the energy quality using advanced KPIs. Thanks to the connectivity features, M4M can take advantage of the integration of scalable energy and asset management in ABB solutions to monitor, optimize and control the entire electrical system.

For more information visit: [link](#)



ABB Ability™ Energy and Asset Manager (EAM)

EAM is the innovative cloud management platform developed to monitor, optimize and manage electrical systems. Among the main features, multisite management, real-time alerts via email and sms, report of the stored values, digital twin of the system, predictive maintenance functions, support to ISO 50001.

For more information visit: [link](#)

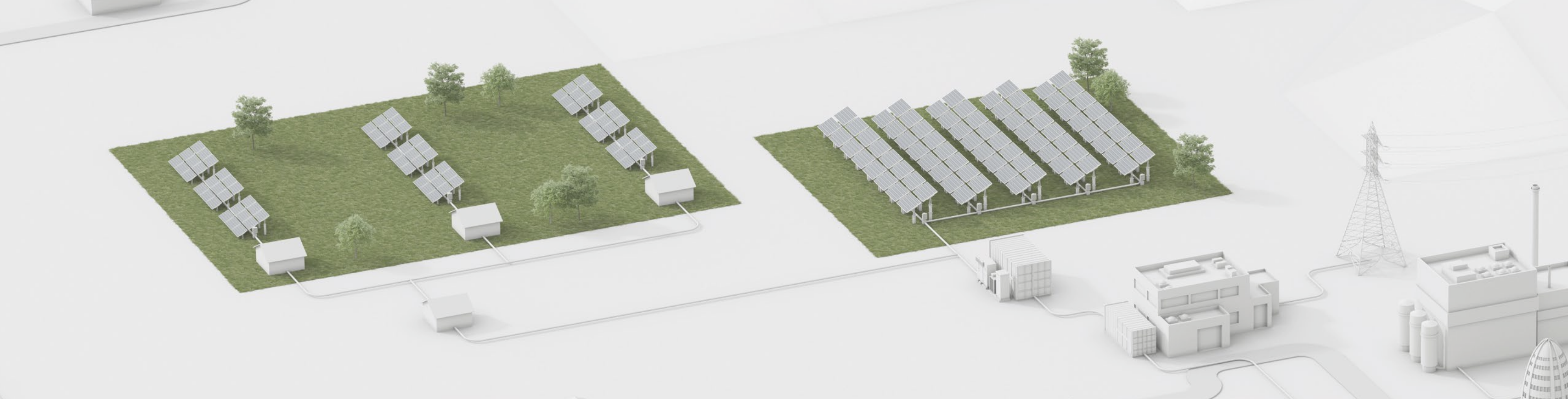

AC

Consumer units, enclosures and low voltage switchboards



Gemini multipurpose enclosures

Gemini switchboards are made through co-injection technology and ABB is the first manufacturer to use it as a molding technique. This process obtains a compact external hard covering and an expanded internal soft core, guaranteeing the highest level of mechanical protection against impacts (IK10). Gemini keeps its mechanical characteristics in the long term.

For more information visit: [link](#)



ARIA

Universal polyester enclosures IP66, IK10, UL, CSA and Lloyd's Register certified. 7 sizes from 315 x 215 x 170 mm up to 1035 x 835 x 300 mm. Self-extinguishing and halogen-free. Corrosion resistant and requires no maintenance.

For more information visit: [link](#)



Polysafe

Polyfunctional enclosures in polyester IP65 / IP54, IK10, UL and CSA certified. 14 standard sizes, from 500 x 500 mm up to 1250 x 1000 mm, combinable with each other and with a 320 mm depth extendable to 640 mm. Factory assembled (empty or equipped).

For more information visit: [link](#)



System pro E power

System pro E power is an innovative solution for main distribution boards with rated current up to 6300A and short-circuit current up to 120kA. Designed to easily respond to all electrical installation requirements in terms of degree of protection, form of segregation and electrical characteristics, according to the latest international Standards and in perfect synergy with all ABB low voltage equipment.

For more information visit: [link](#)

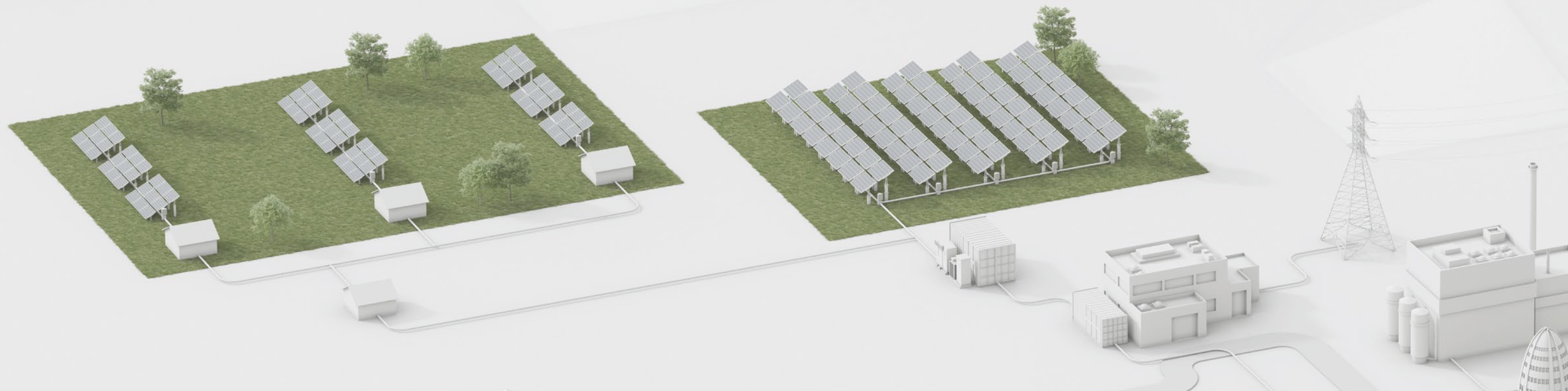

POWER COLLECTION



Unipack CSS

Safe working:

- Internal arc fault and type tested (IEC 62271-202)
- Connected to SCADA
- ABB Ability™ enabled for maintenance and remote management

Optimized life cycle and maintenance cost:

- Corrosion resistant enclosure of Glass Reinforced Polyester

Fast installation, commissioning and relocation:

- Lightweight and factory assembled
- Flexible with wide range of ratings

For more information visit: [link](#)



EcoFlex eHouse

Modular, factory assembled and tested, with ISO dimensions:

- Combinable modules
- Seismic rated
- C5M Coating

Risk mitigation, improved lead time and reduced overall cost:

- Minimal site works
 - Factory production
- Transportable, configurable and standardized:
- Configurable: electrical equipment, floor/wall material, module combinations

- Reduced engineering
- Standard shipping

For more information visit: [link](#)



Secondary Skid Unit

- Pre-configured design solutions
- Factory assembled and routine tested
- One piece delivery for minimizing site works
- Efficient cooling based on an open air design with no additional HVAC required
- No exposed live parts
- ABB Ability™ digitally enabled solution providing predictive maintenance and remote management

For more information visit: [link](#)



eStorage Flex

A compact, fully integrated, pre-engineered, lithium ion battery energy storage system to maximize the return on investment reducing installation time, complexity and transportation costs. It's optimized for functionality, featuring digital intelligence that improves performance and operating costs. Available in different power and energy ratings up to 1300 kW / 1550 kWh in one 40 EcoFlex, ready for AC coupling.

ABB also offers eStorage Max version to support large scale projects, providing a modular "building block" approach optimized following customer needs. Same flexibility and values of eStorage Flex for customer projects at utility scale for 10 MW or more.

For more information visit: [link](#)

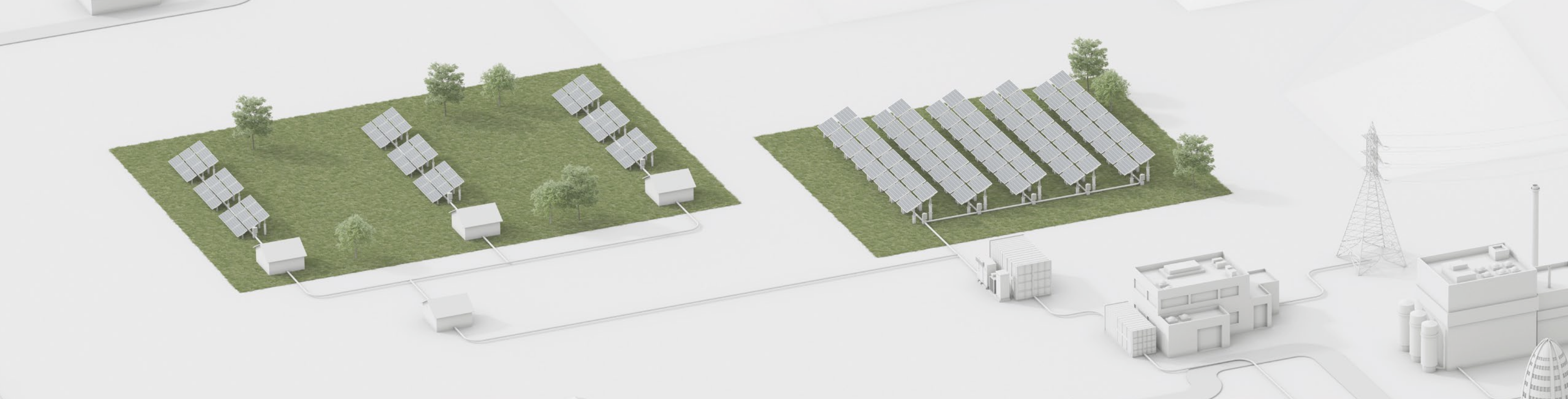

GRID CONNECTION



EcoFlex eHouse

Modular, factory assembled and tested, with ISO dimensions:

- Combinable modules
- Seismic rated
- C5M Coating

Risk mitigation, improved lead time and reduced overall cost:

- Minimal site works
- Factory production

Transportable, configurable and standardized:

- Configurable: electrical equipment, floor/wall material, module combinations
- Reduced engineering
- Standard shipping

For more information visit: [link](#)



eHouse

- Pre-fabricated transportable switch room for electrical switching and distribution
- Total solution responsibility, risk and design interface by ABB
- Predictable delivery and cost schedule with majority of works performed offsite
- Full factory testing improves energization time
- Simplified project management and single commercial agreement

For more information visit: [link](#)



Air-insulated switchgear UniGear family

Switchgear for primary distribution up to 40.5 kV. ABB Ability™ UniGear Digital offers flexibility for any application. The digital solution takes advantage of well-proven components: current & voltage sensors, protection relays with IEC 61850 communication to ensure a reliable electrical network.

For more information visit: [link](#)



Gas-insulated switchgear ZX family

Switchgear for primary distribution up to 40.5 kV. Flexible combination, reliability, availability and economy. Together with complete conventional solutions, the use of digital protection and control technology, sensor systems and plug-in connections make ZX systems fit for the future.

For more information visit: [link](#)

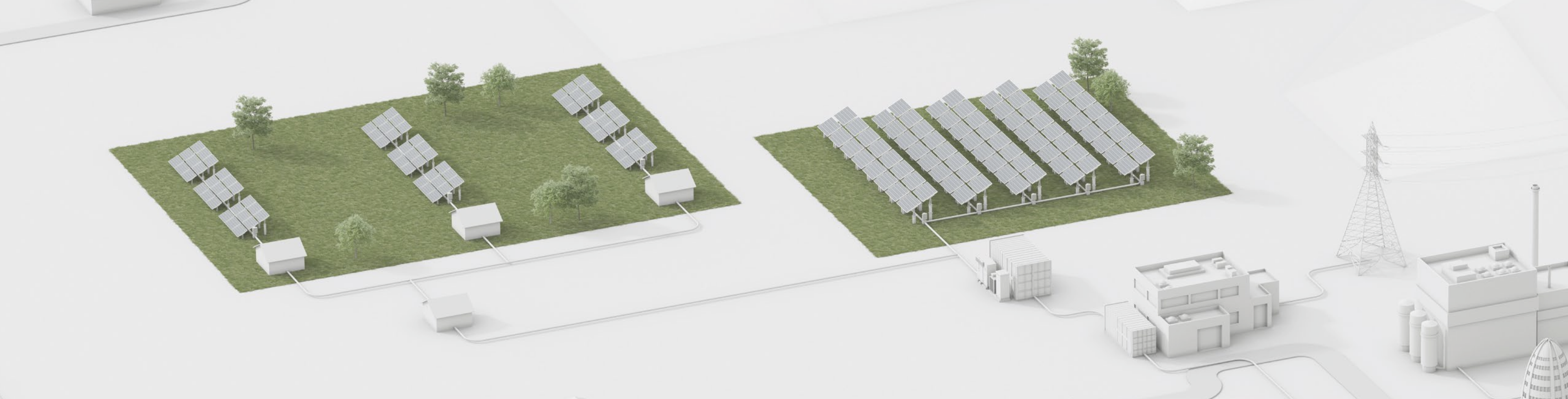

OTHER PRODUCTS



Low voltage switchgear

At the core of ABB low-voltage solutions is the MNS solution platform which, in the age of Industry 4.0, has integrated capabilities to sense, collect and analyze the current and upcoming condition of the electrical assembly through ABB Ability™

For more information visit: [link](#)



External Lightning Protection - OPR

To provide effective protection, the Solar system must be protected against direct lightning strikes and have a proper grounding system in addition to protection against overvoltage on both sides of the inverter. OPR, ESE lightning rod is an active system that protects against direct lightning.

For more information visit: [link](#)



Scalable Electrical Monitoring and Control Systems

This solution leverages and maximizes ABB portfolio across medium- and low-voltage segments. The deployed products are diverse in nature and include EkipUp units, ABB Ability™ Energy and Asset Manager, COM600, ABB zenon Energy Edition, AC500, AC800M together with ABB Relion/legacy relays, 3rd party devices, MV, LV switchgear and associated systems, using communication protocols and Standards such as IEC 61850, Modbus, IEC 60870-5, Profibus and OPC.

For more information visit: [link](#)



ABB Ltd.

Affolternstrasse 44
CH-8050 Zurich
Switzerland

<https://new.abb.com/low-voltage/industries/solar>

The information contained in this document is for general information purposes only. While ABB strives to keep the information up to date and correct, it makes no representations or warranties of any kind, expressed or implied, about the completeness, accuracy, reliability, suitability or availability with respect to the information, products, services, or related graphics contained in the document for any purpose. Any reliance placed on such information is therefore strictly at your own risk.

ABB reserves the right to discontinue any product or service at any time.
© Copyright 2022 ABB. All rights reserved.