

$V_{CE} = 6500 \text{ V}$

$I_C = 750 \text{ A}$

ABB HiPak

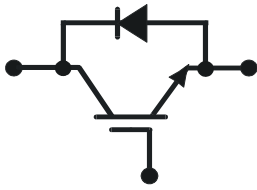

IGBT Module 5SNA 0750G650300

Doc. No. 5SYA 1600-04 03-2016

- Ultra low-loss, rugged SPT+ chip-set
- Smooth switching SPT+ chip-set for good EMC
- High insulation package
- AlSiC base-plate for high power cycling capability
- AlN substrate for low thermal resistance
- Improved high reliability package
- Recognized under UL1557, File E196689



Maximum rated values ¹⁾

| Parameter | Symbol | Conditions | min | max | Unit |
|--------------------------------|--------------|--|-----|-------|--------------------|
| Collector-emitter voltage | V_{CES} | $V_{GE} = 0 \text{ V}$ | | 6500 | V |
| DC collector current | I_C | $T_c = 85 \text{ °C}$ | | 750 | A |
| Peak collector current | I_{CM} | $t_p = 1 \text{ ms}, T_c = 85 \text{ °C}$ | | 1500 | A |
| Gate-emitter voltage | V_{GES} | | -20 | 20 | V |
| Total power dissipation | P_{tot} | $T_c = 25 \text{ °C}$, per switch (IGBT) | | 9500 | W |
| DC forward current | I_F | | | 750 | A |
| Peak forward current | I_{FRM} | | | 1500 | A |
| Surge current | I_{FSM} | $V_R = 0 \text{ V}, T_{vj} = 125 \text{ °C}$, $t_p = 10 \text{ ms}$, half-sinewave | | 8000 | A |
| IGBT short circuit SOA | t_{psc} | $V_{CC} = 4400 \text{ V}, V_{CEMCHIP} \leq 6500 \text{ V}$ $V_{GE} \leq 15 \text{ V}, T_{vj} \leq 125 \text{ °C}$ | | 10 | μs |
| Isolation voltage | V_{isol} | 1 min, $f = 50 \text{ Hz}$ | | 10200 | V |
| Junction temperature | T_{vj} | | | 150 | $^{\circ}\text{C}$ |
| Junction operating temperature | $T_{vj(op)}$ | | -50 | 125 | $^{\circ}\text{C}$ |
| Case temperature | T_c | | -50 | 125 | $^{\circ}\text{C}$ |
| Storage temperature | T_{stg} | | -50 | 125 | $^{\circ}\text{C}$ |
| Mounting torques ²⁾ | M_s | Base-heatsink, M6 screws | 4 | 6 | Nm |
| | M_{t1} | Main terminals, M8 screws | 8 | 10 | |
| | M_{t2} | Auxiliary terminals, M4 screws | 2 | 3 | |

¹⁾ Maximum rated values indicate limits beyond which damage to the device may occur per IEC 60747

²⁾ For detailed mounting instructions refer to ABB Document No. 5SYA2039

ABB Switzerland Ltd, Semiconductors reserves the right to change specifications without notice.



IGBT characteristic values ³⁾

| Parameter | Symbol | Conditions | min | typ | max | Unit |
|--|-------------------------|---|---------------------------|------|-----|---------------|
| Collector (-emitter) breakdown voltage | $V_{(BR)CES}$ | $V_{GE} = 0 \text{ V}$, $I_C = 10 \text{ mA}$, $T_{vj} = 25 \text{ °C}$ | 6500 | | | V |
| Collector-emitter ⁴⁾ saturation voltage | $V_{CE \text{ sat}}$ | $I_C = 750 \text{ A}$, $V_{GE} = 15 \text{ V}$ | $T_{vj} = 25 \text{ °C}$ | 2.9 | | V |
| | | | $T_{vj} = 125 \text{ °C}$ | 3.9 | 4.5 | V |
| Collector cut-off current | I_{CES} | $V_{CE} = 6500 \text{ V}$, $V_{GE} = 0 \text{ V}$ | $T_{vj} = 25 \text{ °C}$ | | 12 | mA |
| | | | $T_{vj} = 125 \text{ °C}$ | 60 | 100 | mA |
| Gate leakage current | I_{GES} | $V_{CE} = 0 \text{ V}$, $V_{GE} = \pm 20 \text{ V}$, $T_{vj} = 125 \text{ °C}$ | -500 | | 500 | nA |
| Gate-emitter threshold voltage | $V_{GE(TO)}$ | $I_C = 240 \text{ mA}$, $V_{CE} = V_{GE}$, $T_{vj} = 25 \text{ °C}$ | 5.5 | | 7.5 | V |
| Gate charge | Q_{ge} | $I_C = 750 \text{ A}$, $V_{CE} = 3600 \text{ V}$, $V_{GE} = -15 \text{ V} .. 15 \text{ V}$ | | 7.4 | | μC |
| Input capacitance | C_{ies} | $V_{CE} = 25 \text{ V}$, $V_{GE} = 0 \text{ V}$, $f = 1 \text{ MHz}$, $T_{vj} = 25 \text{ °C}$ | | 113 | | nF |
| Output capacitance | C_{oes} | | | 6.6 | | |
| Reverse transfer capacitance | C_{res} | | | 2.0 | | |
| Internal gate resistance | R_{Gint} | | | 0.88 | | Ω |
| Turn-on delay time | $t_{d(on)}$ | $V_{CC} = 3600 \text{ V}$, $I_C = 750 \text{ A}$, $R_G = 2.7 \text{ }\Omega$, $C_{GE} = 220 \text{ nF}$, | $T_{vj} = 25 \text{ °C}$ | 1060 | | ns |
| | | | $T_{vj} = 125 \text{ °C}$ | 980 | | |
| Rise time | t_r | $V_{GE} = \pm 15 \text{ V}$, $L_\sigma = 280 \text{ nH}$, inductive load | $T_{vj} = 25 \text{ °C}$ | 260 | | ns |
| | | | $T_{vj} = 125 \text{ °C}$ | 300 | | |
| Turn-off delay time | $t_{d(off)}$ | $V_{CC} = 3600 \text{ V}$, $I_C = 750 \text{ A}$, $R_G = 15 \text{ }\Omega$, $C_{GE} = 220 \text{ nF}$, | $T_{vj} = 25 \text{ °C}$ | 4950 | | ns |
| | | | $T_{vj} = 125 \text{ °C}$ | 5520 | | |
| Fall time | t_f | $V_{GE} = \pm 15 \text{ V}$, $L_\sigma = 280 \text{ nH}$, inductive load | $T_{vj} = 25 \text{ °C}$ | 610 | | ns |
| | | | $T_{vj} = 125 \text{ °C}$ | 590 | | |
| Turn-on switching energy | E_{on} | $V_{CC} = 3600 \text{ V}$, $I_C = 750 \text{ A}$, $R_G = 2.7 \text{ }\Omega$, $C_{GE} = 220 \text{ nF}$, $V_{GE} = \pm 15 \text{ V}$, $L_\sigma = 280 \text{ nH}$, inductive load | $T_{vj} = 25 \text{ °C}$ | 4700 | | mJ |
| | | | $T_{vj} = 125 \text{ °C}$ | 6400 | | |
| Turn-off switching energy | E_{off} | $V_{CC} = 3600 \text{ V}$, $I_C = 750 \text{ A}$, $R_G = 15 \text{ }\Omega$, $C_{GE} = 220 \text{ nF}$, $V_{GE} = \pm 15 \text{ V}$, $L_\sigma = 280 \text{ nH}$, inductive load | $T_{vj} = 25 \text{ °C}$ | 4200 | | mJ |
| | | | $T_{vj} = 125 \text{ °C}$ | 5300 | | |
| Short circuit current | I_{SC} | $t_{psc} \leq 10 \text{ }\mu\text{s}$, $V_{GE} = 15 \text{ V}$, $T_{vj} = 125 \text{ °C}$, $V_{CC} = 4400 \text{ V}$, $V_{CEM \text{ CHIP}} \leq 6500 \text{ V}$ | | 3400 | | A |
| Module stray inductance | $L_{\sigma \text{ CE}}$ | | | 18 | | nH |
| Resistance, terminal-chip | $R_{CC'+EE'}$ | | $T_C = 25 \text{ °C}$ | 0.07 | | m Ω |
| | | | $T_C = 125 \text{ °C}$ | 0.1 | | |

³⁾ Characteristic values according to IEC 60747 – 9⁴⁾ Collector-emitter saturation voltage is given at chip level

Diode characteristic values ⁵⁾

| Parameter | Symbol | Conditions | min | typ | max | Unit |
|-------------------------------|-----------|---|---------------------------|------|-----|---------------|
| Forward voltage ⁶⁾ | V_F | $I_F = 750 \text{ A}$ | $T_{vj} = 25 \text{ °C}$ | 3.2 | 3.8 | V |
| | | | $T_{vj} = 125 \text{ °C}$ | 3.4 | 4.0 | |
| Reverse recovery current | I_{rr} | $V_{CC} = 3600 \text{ V},$ $I_F = 750 \text{ A},$ | $T_{vj} = 25 \text{ °C}$ | 860 | | A |
| | | | $T_{vj} = 125 \text{ °C}$ | 930 | | |
| Recovered charge | Q_{rr} | $V_{GE} = \pm 15 \text{ V},$ $R_G = 2.7 \text{ } \Omega,$ | $T_{vj} = 25 \text{ °C}$ | 920 | | μC |
| | | | $T_{vj} = 125 \text{ °C}$ | 1500 | | |
| Reverse recovery time | t_{rr} | $C_{GE} = 220 \text{ nF},$ $L_{\sigma} = 280 \text{ nH}$ inductive load | $T_{vj} = 25 \text{ °C}$ | 2100 | | ns |
| | | | $T_{vj} = 125 \text{ °C}$ | 3200 | | |
| Reverse recovery energy | E_{rec} | | $T_{vj} = 25 \text{ °C}$ | 1400 | | mJ |
| | | | $T_{vj} = 125 \text{ °C}$ | 2700 | | |

⁵⁾ Characteristic values according to IEC 60747 – 2

⁶⁾ Forward voltage is given at chip level

Package properties ⁷⁾

| Parameter | Symbol | Conditions | min | typ | max | Unit |
|---|--------------------|--|------|------------|-------|------|
| IGBT thermal resistance junction to case | $R_{th(j-c)IGBT}$ | | | | 0.011 | K/W |
| Diode thermal resistance junction to case | $R_{th(j-c)DIODE}$ | | | | 0.021 | K/W |
| IGBT thermal resistance ²⁾ case to heatsink | $R_{th(c-s)IGBT}$ | IGBT per switch, λ grease = $1\text{W/m} \times \text{K}$ | | 0.009 | | K/W |
| Diode thermal resistance ⁷⁾ case to heatsink | $R_{th(c-s)DIODE}$ | Diode per switch, λ grease = $1\text{W/m} \times \text{K}$ | | 0.018 | | K/W |
| Partial discharge extinction voltage | V_e | $f = 50 \text{ Hz}, Q_{PD} \leq 10\text{pC}$ (acc. to IEC 61287) | 5100 | | | V |
| Comparative tracking index | CTI | | | ≥ 600 | | |

²⁾ For detailed mounting instructions refer to ABB Document No. 5SYA2039

Mechanical properties ⁷⁾

| Parameter | Symbol | Conditions | min | typ | max | Unit |
|---------------------------|-----------------------|---|----------------|----------------|-----|------|
| Dimensions | $L \times W \times H$ | Typical , see outline drawing | | 190 x 140 x 48 | | mm |
| Clearance distance in air | d_a | according to IEC 60664-1 and EN 50124-1 | Term. to base: | 40 | | mm |
| | | | Term. to term: | 26 | | |
| Surface creepage distance | d_s | according to IEC 60664-1 and EN 50124-1 | Term. to base: | 64 | | mm |
| | | | Term. to term: | 56 | | |
| Mass | m | | | 1550 | | g |

⁷⁾ Package and mechanical properties according to IEC 60747 – 15

Electrical configuration

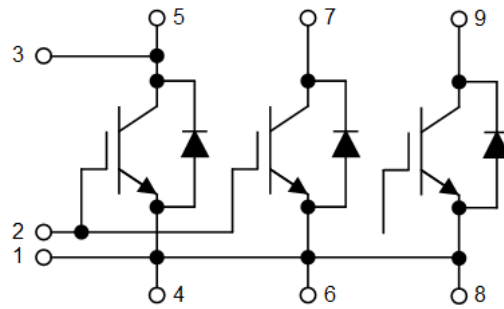

Outline drawing ²⁾

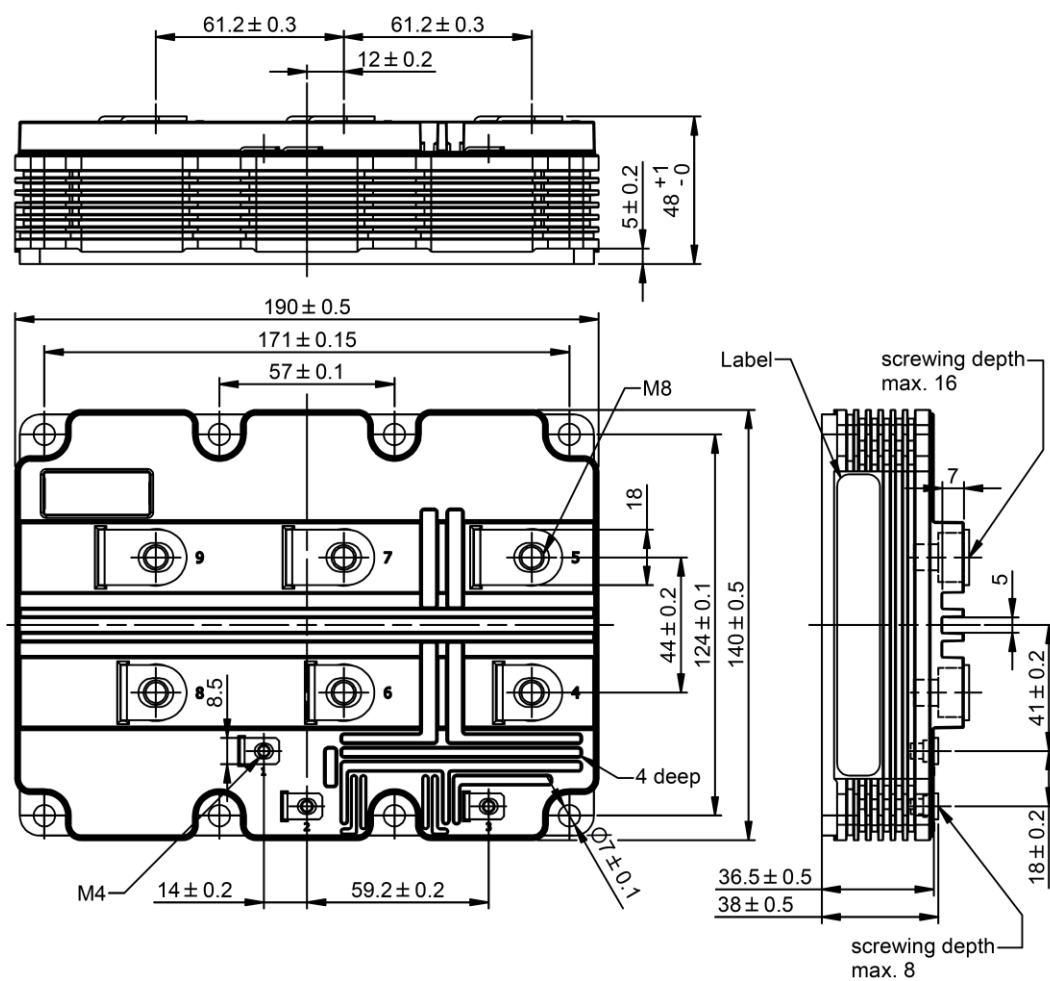

Note: all dimensions are shown in mm

²⁾ For detailed mounting instructions refer to ABB Document No. 5SYA2039

This is an electrostatic sensitive device, please observe the international standard IEC 60747-1, chap. IX.

This product has been designed and qualified for Industrial Level.

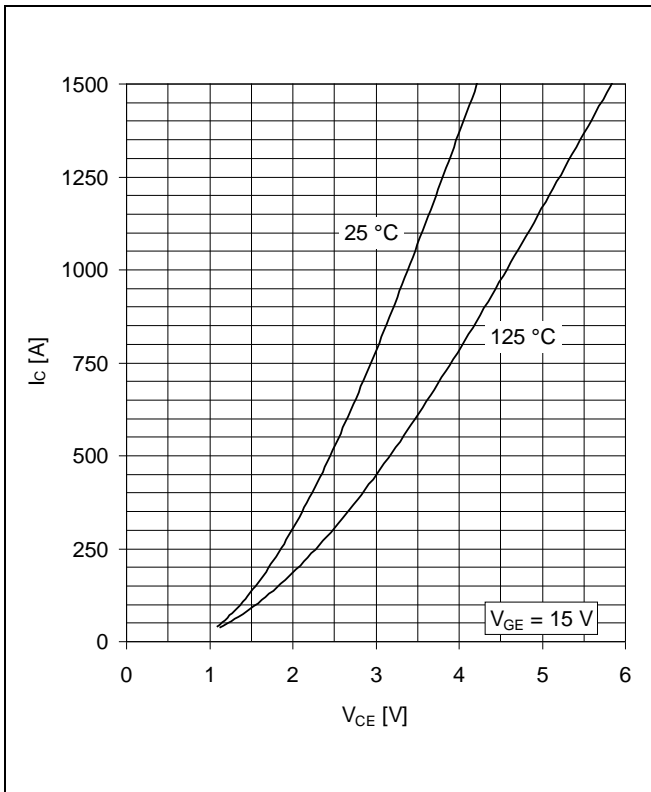

Fig. 1 Typical on-state characteristics, chip level

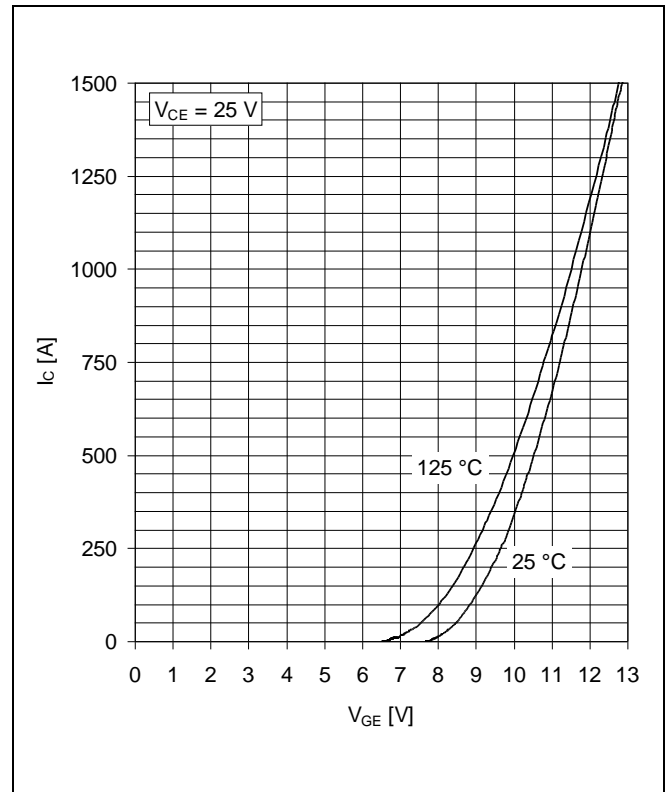

Fig. 2 Typical transfer characteristics, chip level

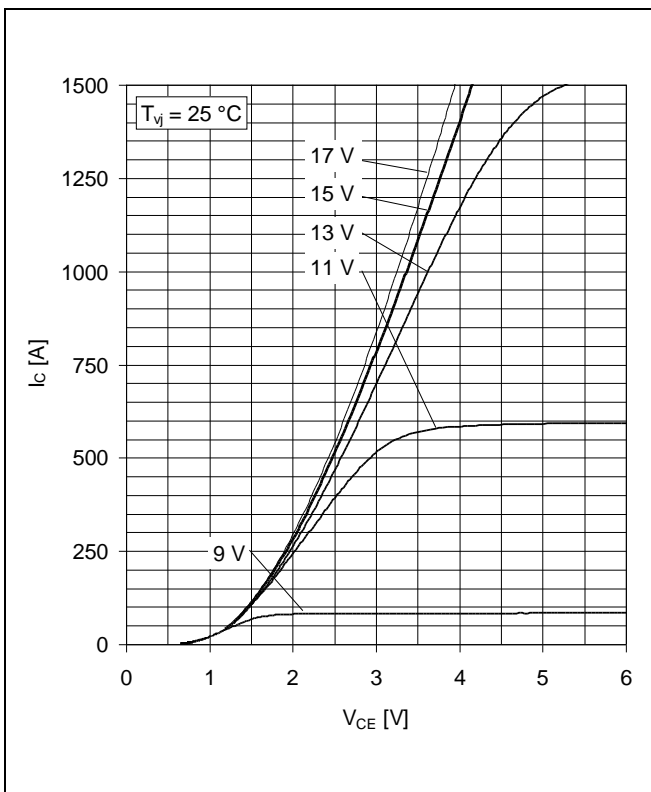

Fig. 3 Typical output characteristics, chip level

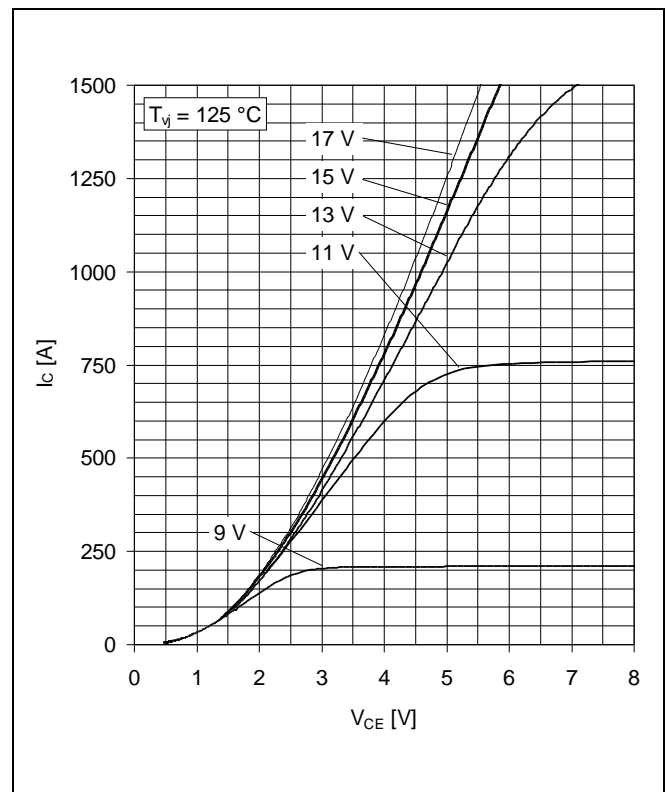

Fig. 4 Typical output characteristics, chip level

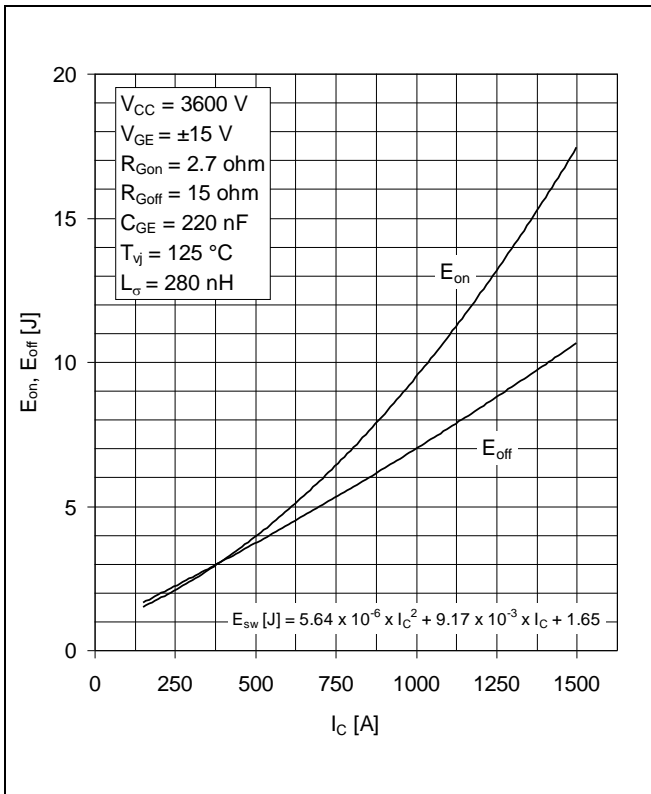

Fig. 5 Typical switching energies per pulse vs collector current

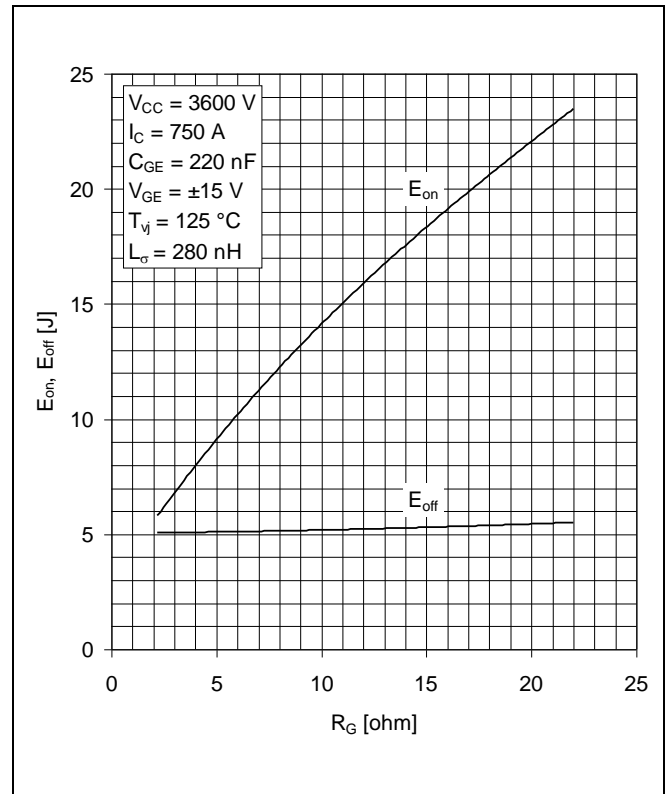

Fig. 6 Typical switching energies per pulse vs gate resistor

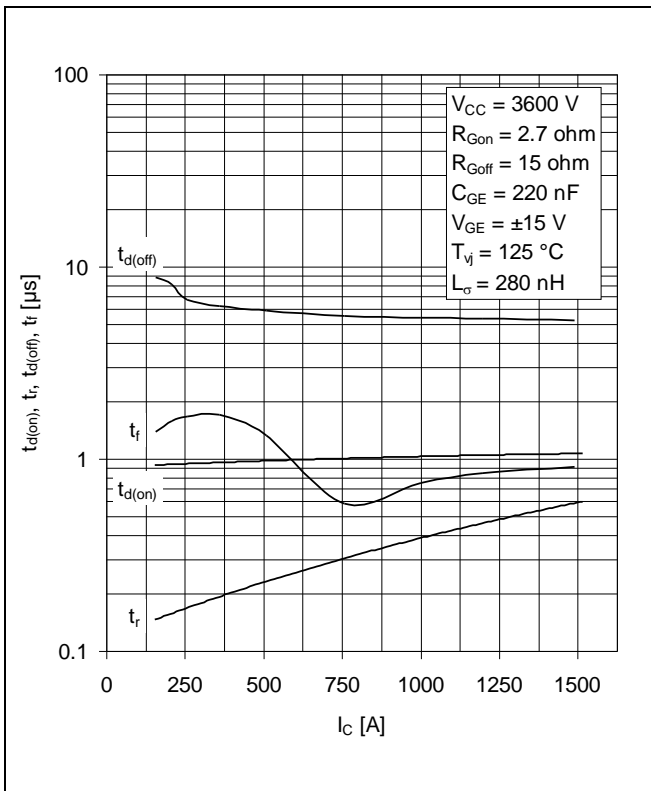

Fig. 7 Typical switching times vs collector current

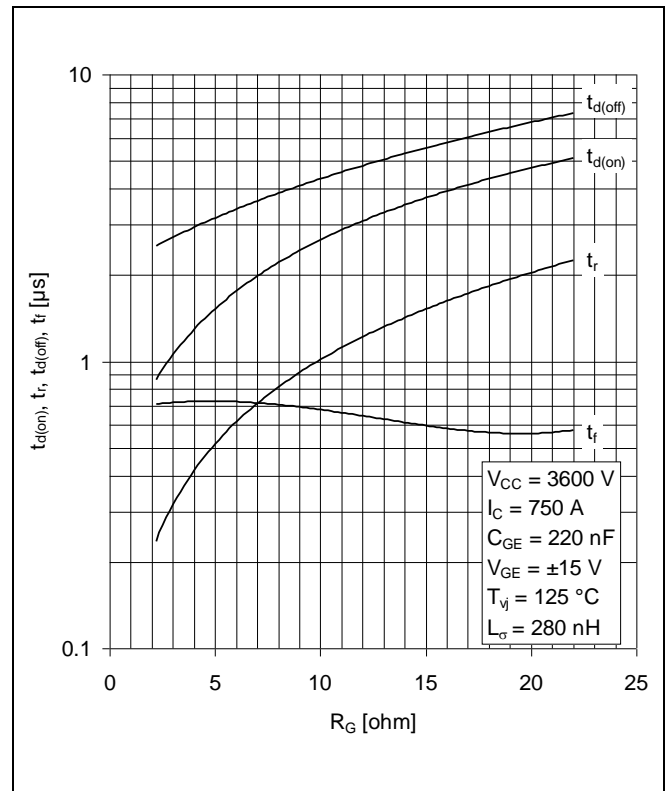

Fig. 8 Typical switching times vs gate resistor

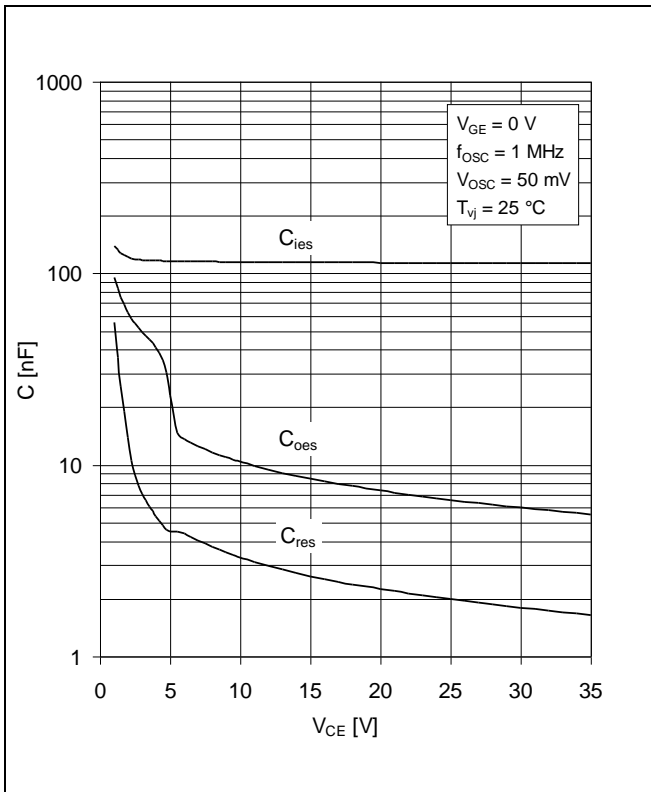

Fig. 9 Typical capacitances vs collector-emitter voltage

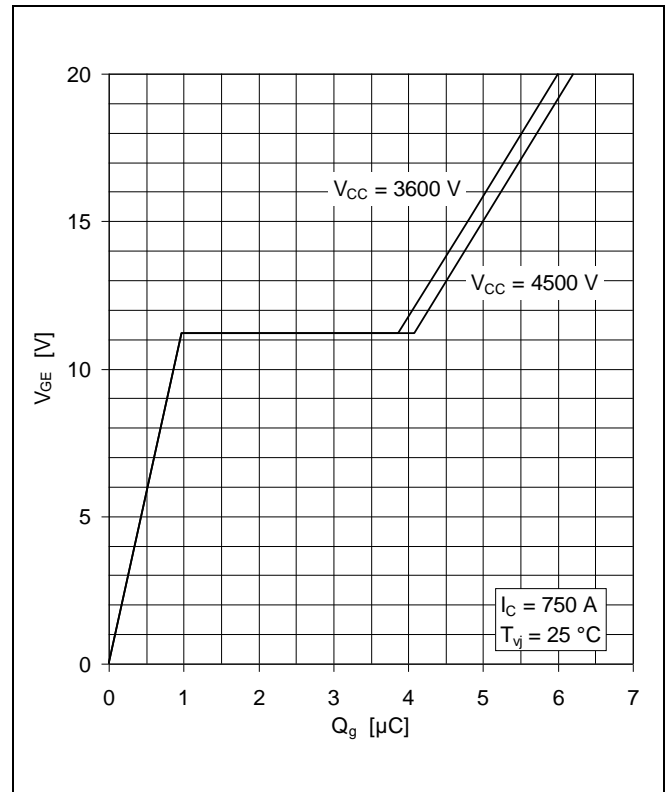

Fig. 10 Typical gate charge characteristics

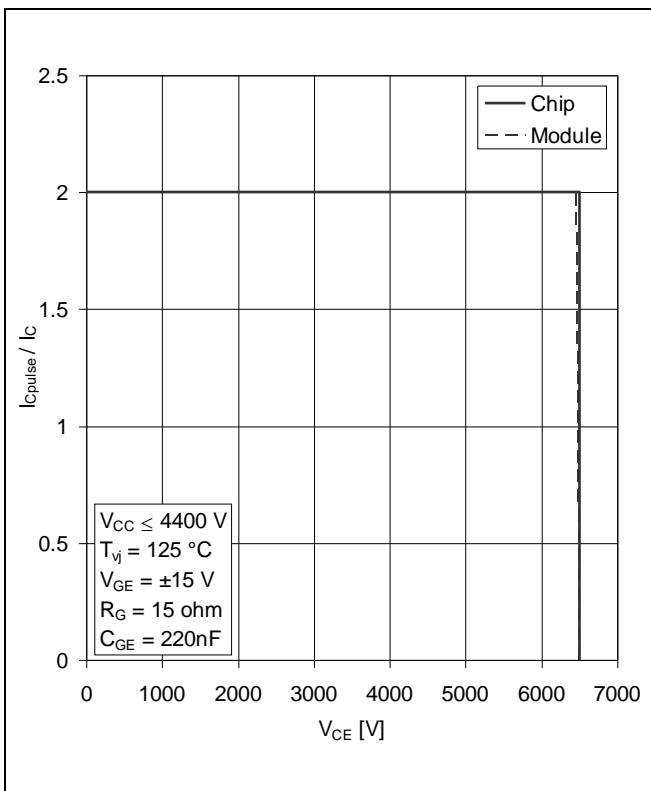

Fig. 11 Turn-off safe operating area (RBSOA)

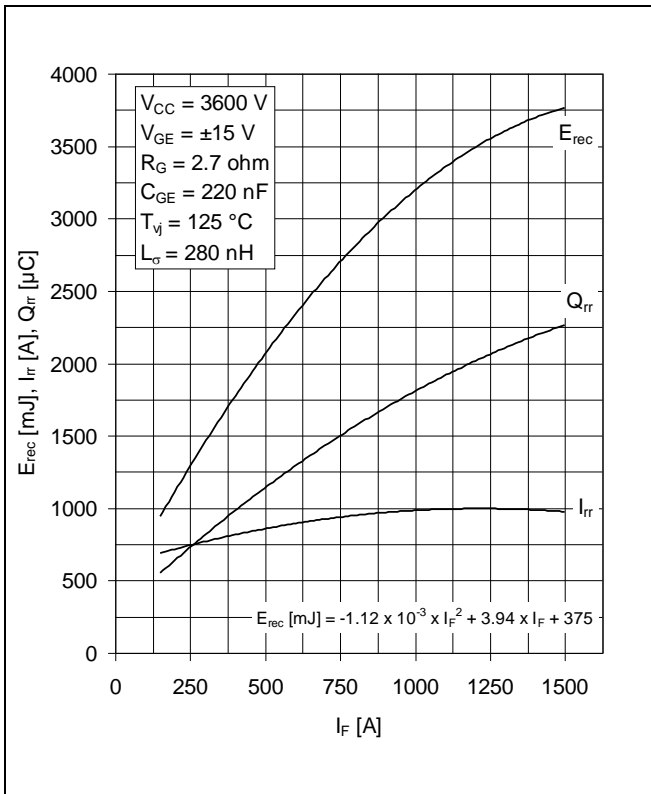

Fig. 12 Typical reverse recovery characteristics vs forward current

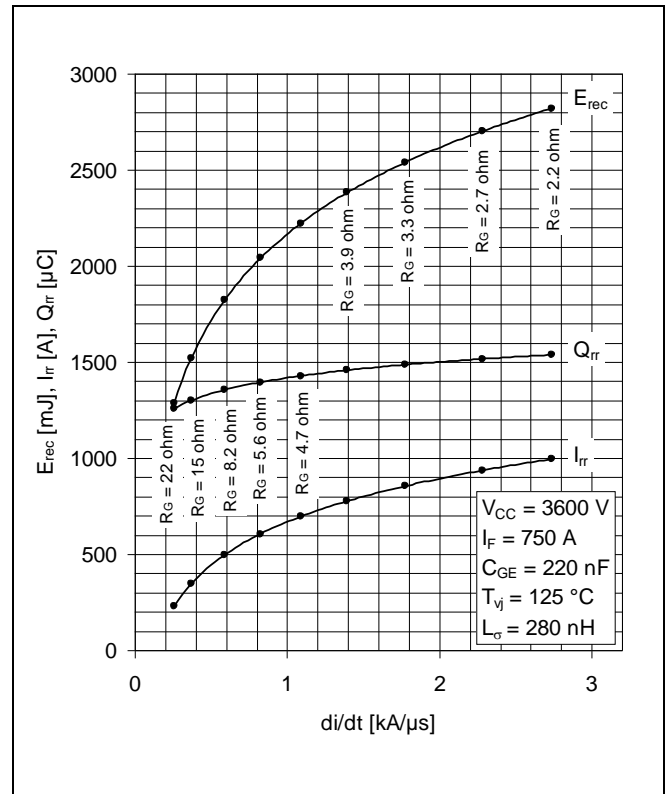

Fig. 13 Typical reverse recovery characteristics vs di/dt

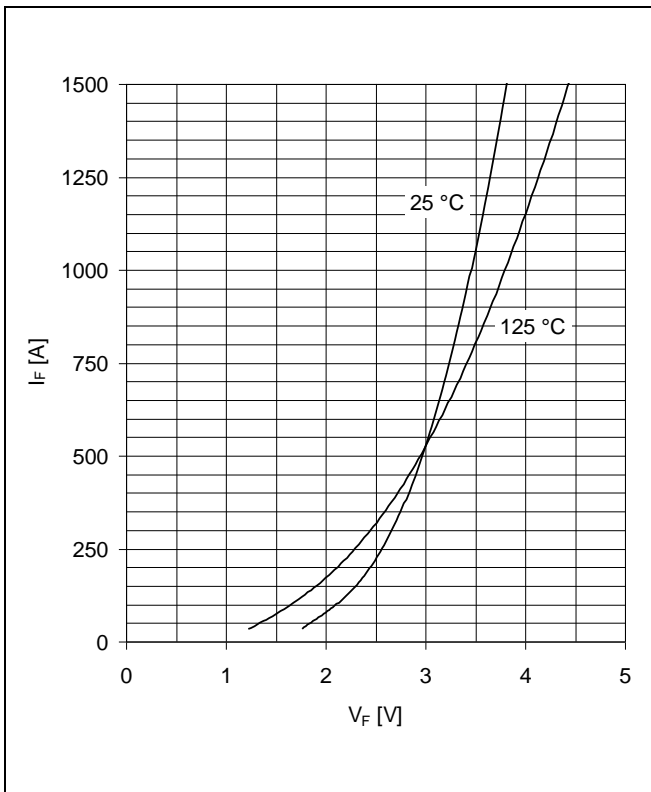

Fig. 14 Typical diode forward characteristics, chip level

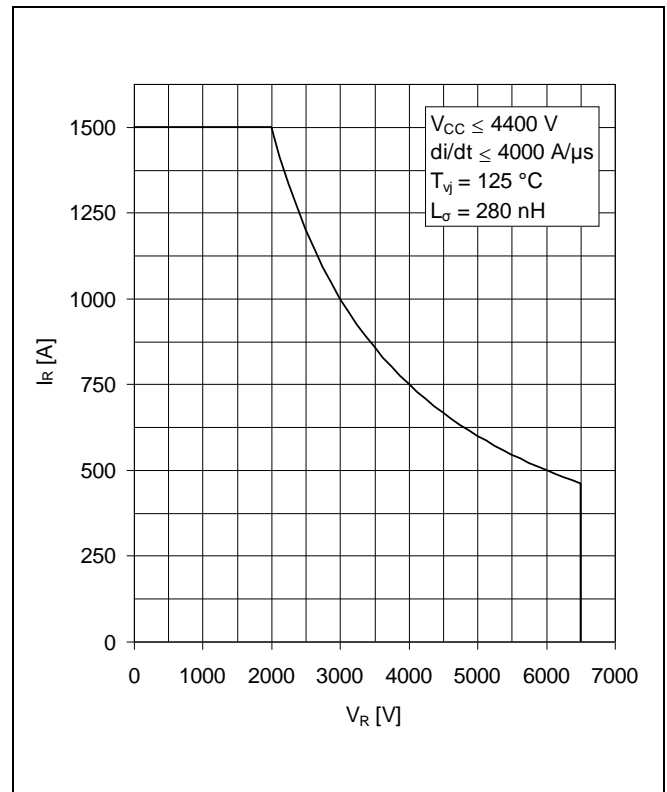

Fig. 15 Safe operating area diode (SOA)

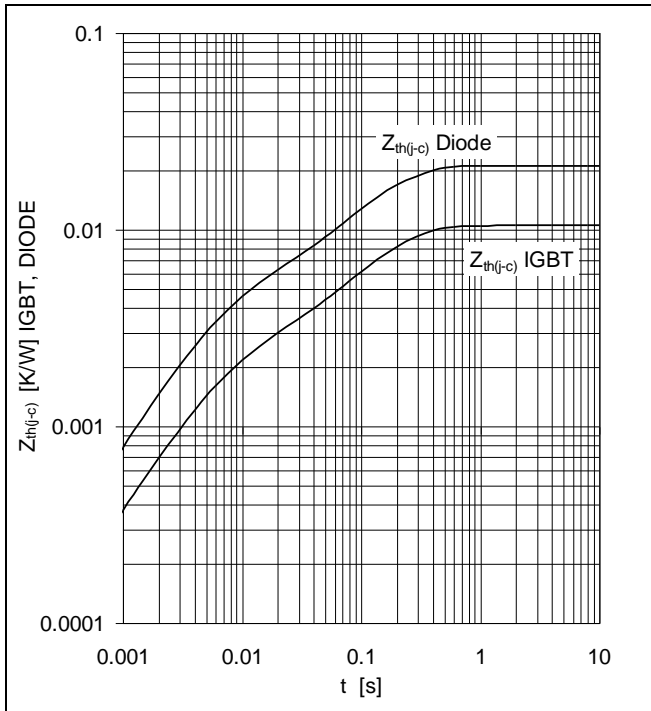

Fig. 16 Thermal impedance vs time

Analytical function for transient thermal impedance:

$$Z_{th(j-c)}(t) = \sum_{i=1}^n R_i (1 - e^{-t/\tau_i})$$

| | | | | | | |
|-------|-----------------------|-----|------|---|---|---|
| | i | 1 | 2 | 3 | 4 | 5 |
| IGBT | R _i (K/kW) | 8.5 | 2 | | | |
| | τ _i (ms) | 151 | 5.84 | | | |
| DIODE | R _i (K/kW) | 17 | 4.2 | | | |
| | τ _i (ms) | 144 | 5.83 | | | |

Related documents:

- 5SYA 2042 Failure rates of HiPak modules due to cosmic rays
- 5SYA 2043 Load - cycle capability of HiPaks
- 5SYA 2045 Thermal runaway during blocking
- 5SYA 2053 Applying IGBT
- 5SYA 2058 Surge currents for IGBT diodes
- 5SYA 2093 Thermal design of IGBT modules
- 5SYA 2098 Paralleling of IGBT modules
- 5SZK 9111 Specification of environmental class for HiPak Storage
- 5SZK 9112 Specification of environmental class for HiPak Transportation
- 5SZK 9113 Specification of environmental class for HiPak Operation (Industry)
- 5SZK 9120 Specification of environmental class for HiPak

We reserve the right to make technical changes or to modify the contents of this document without prior notice.

We reserve all rights in this document and the information contained therein. Any reproduction or utilization of this document or parts thereof for commercial purposes without our prior written consent is forbidden.

Any liability for use of our products contrary to the instructions in this document is excluded.



ABB Switzerland Ltd
Semiconductors
 Fabrikstrasse 3
 CH-5600 Lenzburg, Switzerland

Doc. No. 5SYA 1600-04 03-2016

Telephone +41 (0)58 586 1419
 Fax +41 (0)58 586 1306
 Email abbsem@ch.abb.com
 Internet www.abb.com/semiconductors