FOOD & BEVERAGE

Food & beverage conduit systems

Anti-microbial cable protection

Adaptaflex



ABB food & beverage conduit systems

Anti-microbial cable protection solutions

ABB food and beverage conduit systems, are designed to protect complex processing equipment with sensitive electrical wiring systems, controls and automation. These solutions enable food and beverage processors to increase revenue, plant sustainability, food safety and brand equity.

Given the volume of mechanical process equipment involved in the food and beverage industry combined with the shift towards increased automation through conveyor and feeder systems, there are often thousands of power and data cables that need to be protected. However, cable protection systems like conduits and fittings, can in themselves become a home for bacteria and pose a potential threat in food processing.

The solution created with technology partner BioCote, is to integrate anti-microbial protection in to a new generation of liquid tight conduit. Featuring a smooth, FDA, EC and FSA compliant DuPont Hytrel® thermoplastic jacket, the conduit is complimented by an industry first, single piece liquid tight 316 Stainless Steel fitting. The new system poses a viable alternative to other types of conduit systems and is perfectly suited for the protection of processing equipment and surrounding process area.

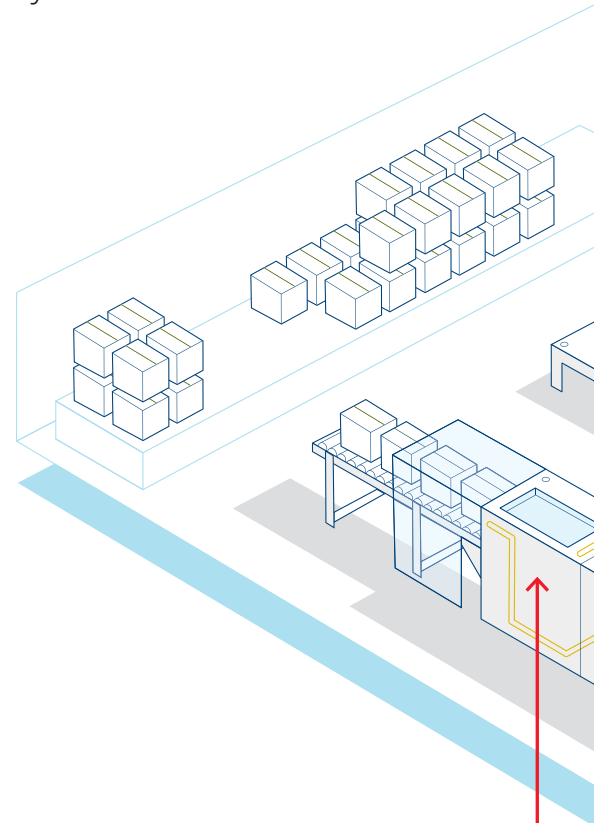

Internal wiring networks

The liquid tight nature of the system - up to IP69 - steel core, anti-microbial protection and new single piece Stainless Steel fitting, combine to protect power and data cables from within, allowing machinery to operate efficiently, safely, and hygienically, without compromising production and systems.

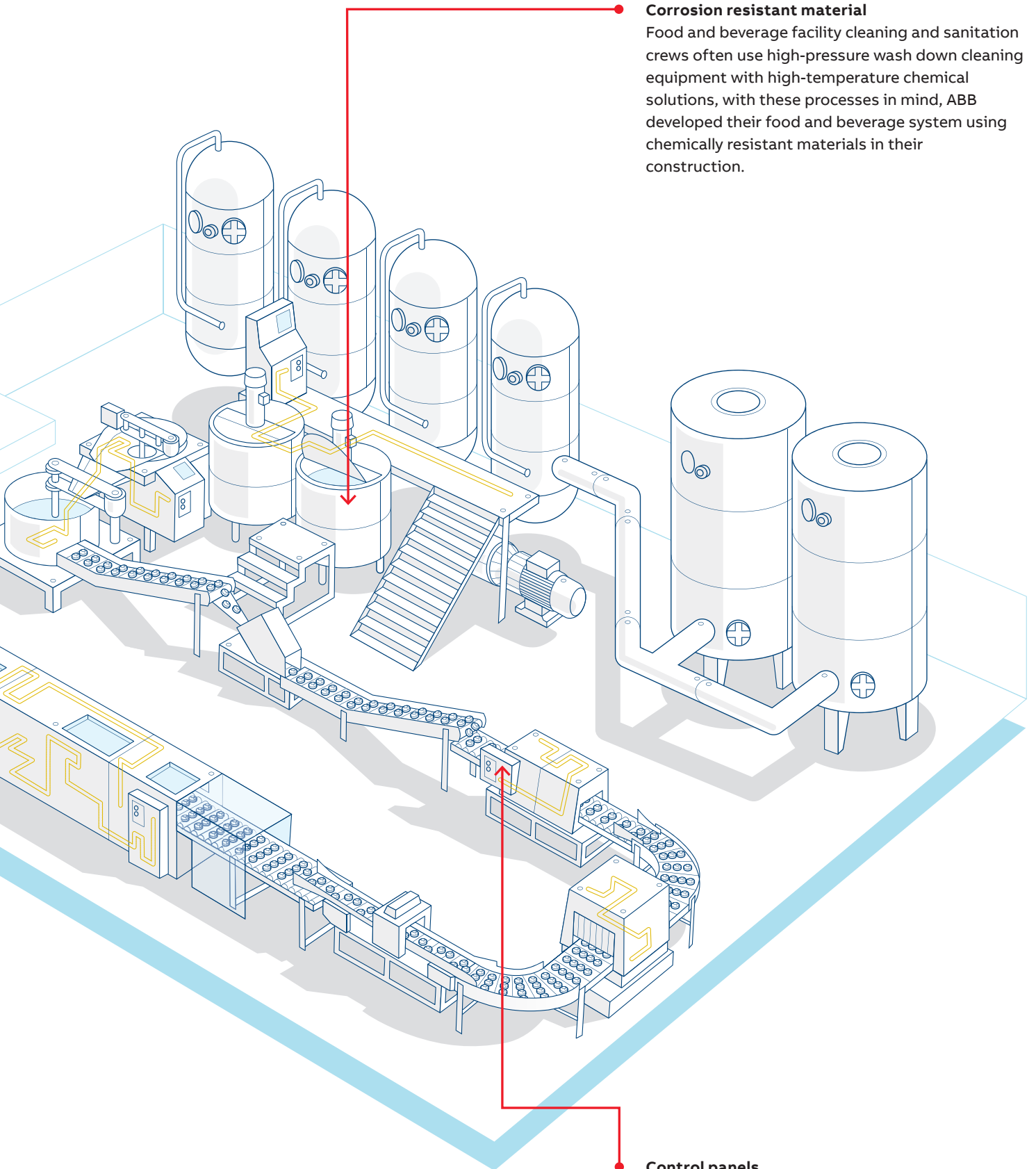
**Corrosion resistant material**

Food and beverage facility cleaning and sanitation crews often use high-pressure wash down cleaning equipment with high-temperature chemical solutions, with these processes in mind, ABB developed their food and beverage system using chemically resistant materials in their construction.

Control panels

Food and beverage processing plants require a high sustainability level from their electrical systems, because shutdowns can cost from minutes' to days' worth of production if a batch must be scrapped.

When clean just isn't clean enough

Cable protection in the food and beverage industry

Making the case for anti-microbial cable protection in the food and beverage industry. The threat of bacterial infection is constant within the food & beverage industry, with mechanical equipment posing a potential area of risk. ABB for Adaptaflex outlines the issue and provides insight into preventing contamination issues.

Health and safety regulations within the food manufacturing industry are notoriously strict and end-users fight a constant battle to ensure that process equipment is operating efficiently, safely, and hygienically, without compromising valuable power and data connections.

Given the volume of mechanical process equipment involved in the food and beverage industry combined with the shift towards increased automation such as conveyor and feeder systems, there are often thousands of power and data cables that need to be protected. However, cable protection systems like conduits and fittings, can in themselves become a home for bacteria and pose a direct threat to food manufacturing.

Stringent health and safety, along with strict infection control measures are required to ensure that bugs, such as listeria, e-coli and salmonella, are killed before they can enter the food production process. As we have seen in recent years, it can take just a single bacterial infection to eradicate decades of consumer trust, crippling a company's finances in the process and miring it in costly litigation battles.

Many different types of conduit systems are used in the food and beverage industry, and these systems are not without their own challenges. It is well known and proven that bacteria can adapt and survive on the various surfaces, meaning a structured and thorough cleaning regime is a must for clean equipment and food safety. Typically, stainless steel equipment is cleaned up to five times a day in order to minimize potential infection. The chosen method, typically called wash-down, are high powered jets with or steam or hot water with chemical agents, typically anywhere from 50°C up to circa 130°C.

—
‘It can take just a single bacterial infection to eradicate decades of consumer trust’

The repeated cleaning process can impact the integrity of cables and wiring leading to the need to replace to ensure an effective system. As such, manufacturers periodically carry out maintenance alongside the installation of cable protection conduit systems, to help mitigate the effects of repeated washdown, abrasion, impact and dust and liquid ingress.

Regular cleaning of equipment, including cable protection conduit systems is required, since it only temporarily reduces the threat of infection. However this increases the likelihood of liquid ingress and material corrosion. With a wash-down, the killing of bacteria is instant, but stops once stimulus (high pressure wash and chemicals) is removed and the equipment dries. This causes an obvious tension between the need for a dry environment to prevent water ingress, whilst, in turn, doing what's needed to hamper bacterial growth.



The solution created with technology partner BioCote, is to integrate anti-microbial protection in to a new generation of liquid tight conduit. a smooth, FDA, EC and FSA compliant DuPont Hytrel® thermoplastic jacket, the conduit is complimented by, an industry first, single piece liquid tight 316 Stainless Steel fitting. The new system poses a viable alternative to other types of conduit systems and is perfectly suited for the protection of processing equipment and surrounding process area.

‘The science behind anti-microbial protection is fascinating’

The anti-microbial additive contains inert ionic silver, meaning it doesn't react or change the appearance of the final product, additionally the additive won't diminish in extreme temperatures, such as steam or deep freeze. Crucially, the anti-microbial protection will not wear off or wash away, as it is more than just a surface coating, in that it is incorporated to form an integral aspect of the product during manufacture. Most importantly, the bacteria cannot survive contact with the silver ions in the anti-microbial protection, because it in effect turns off the bacteria's basic properties.

The science behind anti-microbial protection is fascinating. The silver ions on the surface of a material treated with anti-microbial additives bind with microbes they come into contact with and irreparably damage them, disrupting their normal cell function, stopping them from reproducing and finally resulting in the death of the cell.

Tests completed by BioCote, see the level of bacteria reduced by up to 80% in the first 15 minutes and by 99% in just two hours. Based on the work and materials BioCote provided to ABB, in addition to in-house testing, it's been proven that the effectiveness of the anti-microbial treatment does not degrade over time, throughout storage, or during repeated wash-downs.

Given the size of the food and beverage market, the ABB's range of food and beverage conduit solutions can offer end-users a quantifiable return on investment and help eliminate the risk of bacterial contamination, which could cost the industry both time and money.

‘...see the level of bacteria reduced by up to 80% in the first 15 minutes and by 99% in just two hours’



Type SAMHL, SSAMHL and SAMHURL - Anti microbial liquid tight conduit

Anti-microbial liquid tight high temperature covered steel flexible conduit.
Suitable for food zone non-contact areas

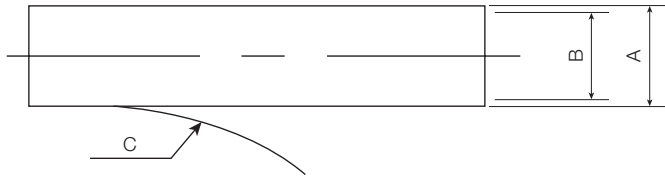

Features

- Type SAMHL - Galvanised steel core string packed with anti-microbial protection incorporated into a FDA, EC and FSA compliant DuPont Hytrel® thermoplastic jacket
- Type SSAMHL - Stainless steel string packed with anti-microbial protection incorporated into a FDA, EC and FSA compliant DuPont Hytrel® thermoplastic jacket
- Type SAMHURL - Galvanised steel core copper packed with anti-microbial protection incorporated into an FDA, EC and FSA compliant DuPont Hytrel® thermoplastic jacket
- IP65 - IP69 rated
- Temperature range -50°C to +130°C

Approvals



Type SAMHL Conformity	Type SSAMHL Conformity	Type SAMHURL Conformity	IP Rating	Appropriate Fitting
Low voltage directive	Low voltage directive	Low voltage directive	For use with: Type SAM fitting	
NSF 14159-1-2014	NSF 14159-1-2014	NSF 14159-1-2014	IP65	Yes
NSF 169-2009	NSF 169-2009	NSF 169-2009	IP68	Yes (10 bar 30mins)
BSI Kitemark KM35161	BSI Kitemark KM35161	UR file number E135398	IP69	Yes
		BSI Kitemark KM35161		
Material	Degree of Mechanical Protection	Temperature Range		
Galvanised steel core with string packing (string packed up to 32mm)	High corrosion resistance	Static Applications: -50°C to +130°C		
Stainless steel core with string packing (string packed up to 32mm), larger sizes double interlocked	High fatigue life	Moving Applications: -5°C to +150°C		
Galvanised steel core with copper packing	High chemical resistance			
FDA, EC and FSA compliant DuPont Hytrel® thermoplastic jacket	High flexibility			
Anti-microbial additive incorporated into Hytrel® jacket				
		Fire Performance		
		Test Standard	Performance Rating	
		IEC61386-1	Self Extinguishing	

Part Numbers and Dimensions									
Part no:	Conduit Size		Dimensions			GID Code for conduit coil lengths			
	Metric (mm)	US (Trade size)	Outside Dia. (A)	Inside Dia. (B)	Bend Radi (C)	10m	25m	50m	--
SAMHL16	16	3/8"	17.8mm	12.5mm	50mm	7TCA296030R0436	7TCA296030R0437	7TCA296030R0438	--
SAMHL20	20	1/2"	21.1mm	15.9mm	80mm	7TCA296030R0439	7TCA296030R0440	7TCA296030R0441	--
SAMHL25	25	3/4"	26.4mm	21.0mm	110mm	7TCA296030R0442	7TCA296030R0443	7TCA296030R0444	--
SAMHL32	32	1"	33.1mm	26.7mm	144mm	7TCA296030R0445	7TCA296030R0446	7TCA296030R0447	--
SAMHL40	40	1 1/4"	41.8mm	35.4mm	180mm	7TCA296030R0448	7TCA296030R0449	--	--
SAMHL50	50	1 1/2"	47.5mm	40.4mm	240mm	7TCA296030R0450	7TCA296030R0451	--	--
SAMHL63	63	2"	59.7mm	51.6mm	345mm	7TCA296030R0452	7TCA296030R0453	--	--

Part number example: SAMHL20/50M, blue version SAMHL20/BU/50M. For conduit support use part number example SSPC20
 Note¹: Conduit is fully cleanable and will maintain full ingress protection under normal wet cleaning conditions with associated fittings
 Note²: The anti-microbial additive containing inert ionic silver provides protection to the conduit against bacteria and other microbes

Part Numbers and Dimensions									
Part no:	Conduit Size		Dimensions			GID Code for conduit coil lengths			
	Metric (mm)	US (Trade size)	Outside Dia. (A)	Inside Dia. (B)	Bend Radi (C)	10m	25m	50ft	100ft
SSAMHL16	16	3/8"	17.8mm	12.5mm	50mm	7TCA296030R0509	7TCA296030R0510	--	7TCA296030R0521
SSAMHL20	20	1/2"	21.1mm	15.9mm	80mm	7TCA296030R0511	7TCA296030R0512	--	7TCA296030R0522
SSAMHL25	25	3/4"	26.4mm	21.0mm	110mm	7TCA296030R0513	7TCA296030R0514	--	7TCA296030R0523
SSAMHL32	32	1"	33.1mm	26.7mm	144mm	7TCA296030R0515	7TCA296030R0516	--	7TCA296030R0524
SSAMHL40	40	1 1/4"	41.8mm	35.4mm	180mm	7TCA296030R0517	--	7TCA296030R0525	--
SSAMHL50	50	1 1/2"	47.5mm	40.4mm	240mm	7TCA296030R0518	--	7TCA296030R0526	--
SSAMHL63	63	2"	59.7mm	51.6mm	345mm	7TCA296030R0519	--	7TCA296030R0527	--

Part number example: SSAMHL20/25M or SSAMHL20/100ft, blue version SSAMHL20/BU/50M. For conduit support use part number example SSPC20
 Note¹: Conduit is fully cleanable and will maintain full ingress protection under normal wet cleaning conditions with associated fittings
 Note²: The anti-microbial additive containing inert ionic silver provides protection to the conduit against bacteria and other microbes

Part Numbers and Dimensions									
Part no:	Conduit Size		Dimensions			GID Code for conduit coil lengths			
	Metric (mm)	US (Trade size)	Outside Dia. (A)	Inside Dia. (B)	Bend Radi (C)	50ft	100ft	--	--
SAMHURL16	16	3/8"	17.8mm	12.5mm	50mm	7TCA296030R0540	7TCA296030R0541	--	--
SAMHURL20	20	1/2"	21.1mm	15.9mm	80mm	7TCA296030R0542	7TCA296030R0543	--	--
SAMHURL25	25	3/4"	26.4mm	21.0mm	110mm	7TCA296030R0544	7TCA296030R0545	--	--
SAMHURL32	32	1"	33.1mm	26.7mm	144mm	7TCA296030R0546	7TCA296030R0547	--	--
SAMHURL40	40	1 1/4"	41.8mm	35.4mm	180mm	7TCA296030R0548	--	--	--
SAMHURL50	50	1 1/2"	47.5mm	40.4mm	240mm	7TCA296030R0549	--	--	--
SAMHURL63	63	2"	59.7mm	51.6mm	345mm	7TCA296030R0550	--	--	--

Part number example: SAMHURL20/50FT, blue version SAMHURL20/BU/50FT. For conduit support use part number example SSPC20
 Note¹: Conduit is fully cleanable and will maintain full ingress protection under normal wet cleaning conditions with associated fittings
 Note²: The anti-microbial additive containing inert ionic silver provides protection to the conduit against bacteria and other microbes

Type SAM - Single piece, stainless steel liquid tight fitting

Single piece, liquid tight, high temperature stainless steel fitting suitable for food zone non-contact areas

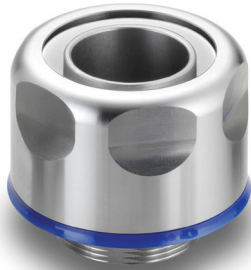

Features

- Unique single piece design
- 316 Stainless Steel
- IP65 - IP69 protection
- Approvals: CE, BS EN 61386-1,-23, NSF14159-1-2014, NSF169-2009, UL514b
- Multiple thread type Metric/NPT

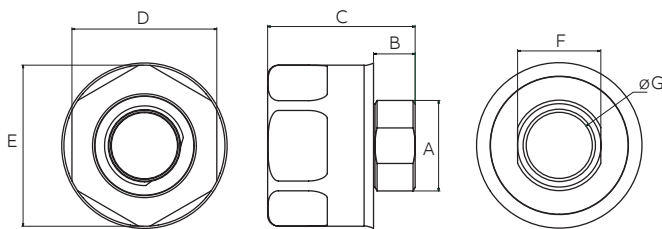

Approvals



IP Rating Appropriate Fitting

For use with: Type SAMHL, SSAMHL & SAMHURL conduit

IP65	Yes
IP68	Yes (10 bar 30mins)
IP69	Yes

Degree of Mechanical Protection

Very high corrosion resistance
Very high chemical resistance
Very high fatigue life

Material

Stainless steel

Conformity

CE marked to Low Voltage Directive 2014/35/EU

BSI Kitemark KM35161 to BS EN 61386

UL514b file number E60625

NSF 14159-1-2014

NSF 169-2009

Temperature Range

Static Applications:
-50°C to +130°C

Moving Applications:
-5°C to +150°C

Part Numbers and Dimensions

METRIC Part no:	Conduit Size (A)		Nominal Dimensions (mm)						GID code
	Metric (mm)	US (Trade size)	B	C	D	E	F	G	
SPL16/M16/SAM	16	3/8"	12.0	32.8	30.0	31.9	14.0	10.5	7TCA296120R0043
SPL20/M20/SAM	20	1/2"	12.0	35.6	32.0	35.0	18.0	14.5	7TCA296120R0044
SPL25/M25/SAM	25	3/4"	12.0	43.0	38.0	41.0	23.0	18.3	7TCA296120R0045
SPL32/M32/SAM	32	1"	12.0	51.5	45.0	49.0	30.0	24.1	7TCA296120R0046
SPL40/M40/SAM	40	1 1/4"	12.0	53.3	57.0	61.5	38.0	32.7	7TCA296120R0047
SPL50/M50/SAM	50	1 1/2"	12.0	60.2	64.0	69.0	48.0	37.7	7TCA296120R0048
SPL63/M63/SAM*	63	2"	12.0	71.4	80.0	87.0	61.0	49.0	7TCA296120R0049

Part Numbers and Dimensions

NPT Part no:	Conduit Size (A)		Nominal Dimensions (mm)						GID code
	US (Trade size)	Metric (mm)	B	C	D	E	F	G	
SPL16/038/SAM	3/8"	16	15.2	43.0	30.0	31.9	14.0	10.5	7TCA296120R0053
SPL20/050/SAM	1/2"	20	19.8	43.2	32.0	35.0	18.0	14.5	7TCA296120R0054
SPL25/075/SAM	3/4"	25	20.1	46.3	38.0	41.0	23.0	18.3	7TCA296120R0055
SPL32/100/SAM	1"	32	25.0	57.9	45.0	49.0	30.0	24.1	7TCA296120R0056
SPL40/125/SAM	1 1/4"	40	25.6	60.4	57.0	61.5	38.0	32.7	7TCA296120R0057
SPL50/150/SAM	1 1/2"	50	26.0	64.7	64.0	69.0	48.0	37.7	7TCA296120R0058
SPL63/200/SAM*	2"	63	26.9	74.1	80.0	87.0	61.0	49.0	7TCA296120R0059

*: Currently does not conform to UL514b

Note¹: A flat surface greater than diameter "E" is required around the knockout on the box or enclosure for the face seal of the NPT fitting to create a liquid tight seal. (The NPT threads alone will not provide a liquid tight seal when installed in a female NPT hub)

Note²: Parts are maintenance free, face seal can be replaced if damaged.

Note³: Parts are fully cleanable and will maintain full ingress protection under normal wet cleaning conditions

P-Clip & Locknut stainless steel conduit

316 stainless steel clip and female threaded locknut

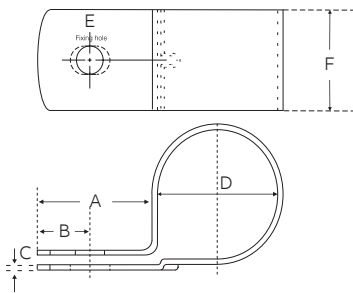

Part Numbers and Dimensions									
Part no:	Conduit Size		Nominal Dimensions (mm)						GID code
	Metric (mm)	US (Trade size)	A	B	C	D	E	F	
SSPC16	16	3/8"	19.0	9.0	0.7	16	6.0	12.7	7TCA296120R0065
SSPC20	20	1/2"	19.0	9.0	0.7	20	6.0	12.7	7TCA296120R0066
SSPC25	25	3/4"	19.0	9.0	0.7	25	6.0	12.7	7TCA296120R0067
SSPC32	32	1"	19.0	9.0	0.7	32	6.0	12.7	7TCA296120R0068
SSPC40	40	1 1/4"	19.0	9.0	0.9	40	6.0	12.7	7TCA296120R0069
SSPC50	50	1 1/2"	19.0	9.0	0.9	50	6.0	12.7	7TCA296120R0070
SSPC63	63	2"	19.0	9.0	0.9	63	6.0	12.7	7TCA296120R0071

Temperature Range
Static Applications: -50°C to +130°C
Moving Applications: -5°C to +150°C

Degree of Mechanical Protection
Very high corrosion resistance
Very high chemical resistance
Very high fatigue life

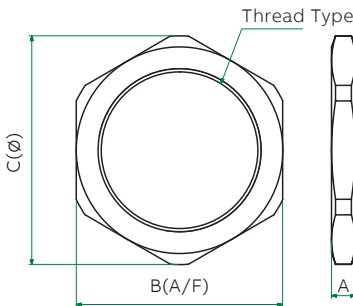

Part Numbers and Dimensions					
METRIC Part no:	Thread Size	Nominal Dimensions			GID code
		A	B	C	
LNSS/M16	M16 x 1.5	3.0	20.0	21.1	7TCA296120R0061
LNSS/M20	M20 x 1.5	3.5	24.0	26.6	7TCA296120R0062
LNSS/M25	M25 x 1.5	4.0	30.0	33.2	7TCA296120R0063
LNSS/M32	M32 x 1.5	5.0	36.0	39.9	7TCA296120R0064
LNSS/M40	M40 x 1.5	5.0	47.2	52.3	7TCA296120R0072
LNSS/M50	M50 x 1.5	5.0	60.3	66.5	7TCA296120R0073
LNSS/M63	M63 x 1.5	6.0	69.8	77.6	7TCA296120R0074

Part Numbers and Dimensions					
NPSL Part no:	Thread Size	Nominal Dimensions			GID code
		A	B	C	
LNSS/038	3/8"	3.0	20.0	21.1	7TCA296120R0075
LNSS/050	1/2"	3.0	27.0	30.0	7TCA296120R0076
LNSS/075	3/4"	3.5	30.0	33.2	7TCA296120R0077
LNSS/100	1"	5.0	38.0	42.0	7TCA296120R0078
LNSS/125	1 1/4"	5.5	52.0	57.5	7TCA296120R0079
LNSS/150	1 1/2"	6.0	60.0	66.5	7TCA296120R0080
LNSS/200	2"	7.0	69.8	77.0	7TCA296120R0081

Raising standards of cleanliness in food & beverage

An innovative partnership with BioCote

Discussing ABB's partnership with global antimicrobial solution provider BioCote.

In 2008 the global food and beverage sector was valued at \$5.7trillion, rising to nearly \$7trillion in 2014, making it the world's largest industrial sector. However, poor cable protection choices by manufacturers contributes to the collective cost of millions linked to bacterial contamination and the knock-on effects of downtime.

Faced with stringent health and safety standards within challenging environments – from sub-zero to elevated temperatures – processors in the food and beverage industry fight a constant battle to ensure equipment operates efficiently, safely, and hygienically, without compromising valuable power and data connections.

However, cable protection systems like conduits and fittings, can in themselves become a home for bacteria and pose a direct threat to food manufacturing. It is well known and proven that bacteria can adapt and survive on the various surfaces, meaning a structured and thorough cleaning regime is a must for clean equipment and food safety.

Regular cleaning is required, since it only temporarily reduces the threat of infection. However this increases the likelihood of liquid ingress and material corrosion. With a wash-down, the killing of bacteria is instant, but stops once stimulus (high pressure wash and chemicals) is removed and the equipment dries. This causes an obvious tension between the need for a dry environment to prevent water ingress, whilst, in turn, doing what's needed to hamper bacterial growth.

To tackle this problem ABB has formed a commercial partnership with anti-microbial protection experts, BioCote, to introduce a cable protection solution that can withstand the challenging environment of the food and beverage industry, and is proven to eradicate up to 99.9% of contaminating bacteria. The new liquid tight conduit from ABB for Adaptaflex, features a smooth FDA, EC and FSA compliant DuPont Hytrel®

thermoplastic jacket, with integral anti-microbial protection incorporating an ionic silver additive. An industry first, single piece liquid tight 316 Stainless Steel fitting completes the system.

Based on a silver glass powder matrix, the anti-microbial additive provides a slow release of silver ions to the surface of the product protecting against bacterial contamination and the growth of mold, whilst providing highly chemical resistant properties.

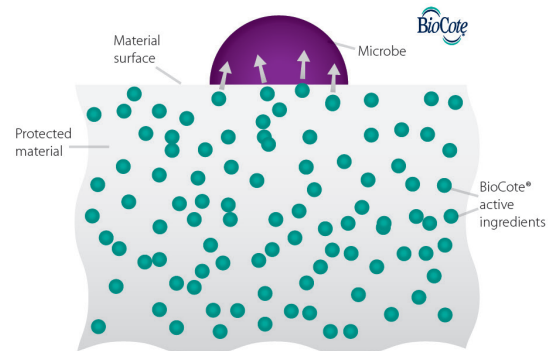

The liquid tight nature of the system - up to IP69 – and anti-microbial protection, combine to protect power and data cables within, from extreme temperatures and the subsequent wear from regular daily wash downs. Crucially, the integral anti-microbial protection, which neither wears off or washes away, attacks both gram negative and gram positive bacteria, such as MRSA and E.coli, with testing showing reductions in bacteria within 15 minutes compared to an untreated surface.

“The biocidal coating attacks bacteria that comes into contact with it, eliminating upto 99% of bacteria in a couple of hours...”





Guy Charteris, Partner Development Manager at BioCote Ltd comments:

“Given the volume of mechanical process equipment involved in the food and beverage industry, such as pumps and motors, combined with the shift towards increased automation, there are often thousands of power and data cables that need to be protected. The ever present and biggest threat to a food and beverage manufacturer is bacteria. Health and safety and infection controls, mean daily equipment wash downs often using chemicals and at high temperatures, are common place.

—
 ‘...the integral anti-microbial protection, which neither wears off or washes away, attacks both gram negative and gram positive bacteria, such as MRSA and E.coli.’

“As we have seen in recent years, it can take just a single bacterial infection to eradicate decades of consumer trust, crippling a company’s finances in the process. Though anti-microbial technology should not be viewed as a replacement to cleaning, the addition of anti-microbial additives, enhances the system integrity proven by our repeated testing and observations showing bacterial reductions of up to 80% in just 15 mins on the treated conduit systems compared to untreated systems, rising to a 99% bacteria reduction in two hours.”

Meirion Buck, Senior Design & Technical Manager at ABB for Adaptaflex comments:

“As liquid tight conduit systems are used across all food and beverage manufacturing sites, we have developed the new system with BioCote, to help give manufacturers piece of mind when it comes to infection protection. The biocidal coating attacks bacteria that comes into contact with it, eliminating up to 99% of bacteria in just a couple of hours, reducing the potential risk of contamination, ultimately reducing the amount of downtime and material cost spent on maintaining cable protection systems. Given the size of the global food and beverage market, the new range can offer end users a quantifiable return on investment and help eliminate the risk of bacterial contamination.”

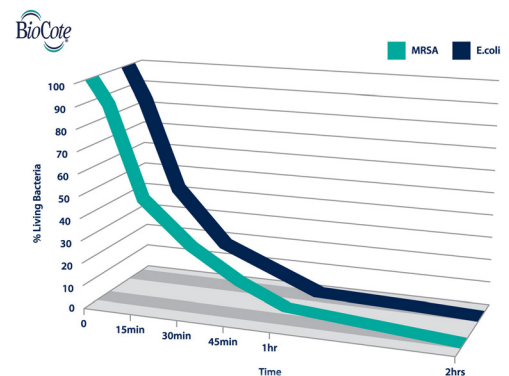

ANTI-MICROBIAL CABLE PROTECTION SOLUTIONS

The next generation of cable protection for the food and beverage industry





Additional information

We reserve the right to make technical changes or modify the contents of this document without prior notice. With regard to purchase orders, the agreed particulars shall prevail. ABB AG does not accept any responsibility whatsoever for potential errors or possible lack of information in this document.

We reserve all rights in this document and in the subject matter and illustrations contained therein. Any reproduction, disclosure to third parties or utilization of its contents – in whole or in parts – is forbidden without prior written consent of ABB AG.

—

ABB Ltd.

Tower Court
Courtaulds Way
Foleshill Enterprise Park
Coventry, CV6 5NX
UK Sales Support tel: +44 (0) 2476 368500
Customer services: lv.customerservice@gb.abb.com
Technical Support e-mail: cmg.conduitsystems@tnb.com

www.adaptaflex.com

abb.com/low-voltage

