

5SNE 1600E170300

HiPak Chopper IGBT Module

 $V_{CE} = 1700 \text{ V}$
 $I_C = 1600 \text{ A}$

Ultra low-loss, rugged SPT+ chip-set
 Smooth switching SPT+ chip-set for good EMC
 AISiC base-plate for high power cycling capability
 AlN substrate for low thermal resistance
 Improved high reliability package

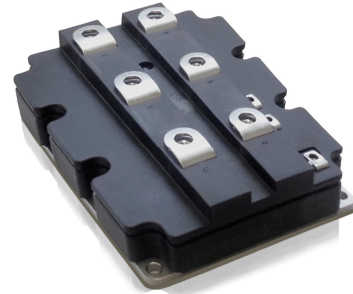

Maximum rated values ¹⁾

Parameter	Symbol	Conditions	min	max	Unit
Collector-emitter voltage	V_{CES}	$V_{GE} = 0 \text{ V}$, $T_{vj} \geq 25 \text{ °C}$		1700	V
DC collector current	I_C	$T_C = 70 \text{ °C}$, $T_{vj} = 150 \text{ °C}$		1600	A
Peak collector current	I_{CM}	$t_p = 1 \text{ ms}$		3200	A
Gate-emitter voltage	V_{GES}		-20	20	V
Total power dissipation	P_{tot}	$T_C = 25 \text{ °C}$, $T_{vj} = 150 \text{ °C}$		11900	W
DC forward current	I_F			1600	A
Peak forward current	I_{FRM}	$t_p = 1 \text{ ms}$		3200	A
Surge current	I_{FSM}	$V_R = 0 \text{ V}$, $T_{vj} = 150 \text{ °C}$, $t_p = 10 \text{ ms}$, half-sinewave		12000	A
IGBT short circuit SOA	t_{psc}	$V_{CC} = 1200 \text{ V}$, $V_{CEM \text{ CHIP}} \leq 1700 \text{ V}$ $V_{GE} \leq 15 \text{ V}$, $T_{vj \text{ start}} \leq 150 \text{ °C}$		10	μs
Isolation voltage	V_{isol}	1 min, $f = 50 \text{ Hz}$		4000	V
Junction temperature	T_{vj}			175	$^{\circ}\text{C}$
Junction operating temperature	$T_{vj(op)}$		-50	150	$^{\circ}\text{C}$
Case temperature	T_C		-50	150	$^{\circ}\text{C}$
Storage temperature	T_{stg}		-50	125	$^{\circ}\text{C}$
Mounting torques ²⁾	M_s	Base-heatsink, M6 screws	4	6	Nm
	M_{t1}	Main terminals, M8 screws	8	10	
	M_{t2}	Auxiliary terminals, M4 screws	2	3	

¹⁾ Maximum rated values indicate limits beyond which damage to the device may occur per IEC 60747

²⁾ For detailed mounting instructions refer to ABB Document No. 5SYA 2039

IGBT characteristic values ³⁾

Parameter	Symbol	Conditions	min	typ	max	Unit	
Collector (-emitter) breakdown voltage	$V_{(BR)CES}$	$V_{GE} = 0 \text{ V}$, $I_C = 10 \text{ mA}$, $T_{vj} = 25 \text{ }^\circ\text{C}$	1700			V	
Collector-emitter ⁴⁾ saturation voltage	$V_{CE \text{ sat}}$	$I_C = 1600 \text{ A}$, $V_{GE} = 15 \text{ V}$	$T_{vj} = 25 \text{ }^\circ\text{C}$	1.8	2.05	2.3	V
			$T_{vj} = 125 \text{ }^\circ\text{C}$	2.15	2.4	2.65	V
			$T_{vj} = 150 \text{ }^\circ\text{C}$		2.45		V
Collector cut-off current	I_{CES}	$V_{CE} = 1700 \text{ V}$, $V_{GE} = 0 \text{ V}$	$T_{vj} = 25 \text{ }^\circ\text{C}$		0.02	1	mA
			$T_{vj} = 125 \text{ }^\circ\text{C}$		20	40	mA
			$T_{vj} = 150 \text{ }^\circ\text{C}$		120		mA
Gate leakage current	I_{GES}	$V_{CE} = 0 \text{ V}$, $V_{GE} = \pm 20 \text{ V}$, $T_{vj} = 125 \text{ }^\circ\text{C}$	-500		500	nA	
Gate-emitter threshold voltage	$V_{GE(TO)}$	$I_C = 160 \text{ mA}$, $V_{CE} = V_{GE}$, $T_{vj} = 25 \text{ }^\circ\text{C}$	5.3		7.3	V	
Gate charge	Q_{ge}	$I_C = 1600 \text{ A}$, $V_{CE} = 900 \text{ V}$, $V_{GE} = -15 \text{ V} \dots 15 \text{ V}$		14		μC	
Internal gate resistance	R_{Gint}			0.8		Ω	
Turn-on delay time	$t_{d(on)}$	$V_{CC} = 900 \text{ V}$, $I_C = 1600 \text{ A}$, $R_G = 0.9 \text{ } \Omega$, $C_{GE} = 0 \text{ nF}$, $V_{GE} = \pm 15 \text{ V}$, $L_S = 75 \text{ nH}$, inductive load	$T_{vj} = 25 \text{ }^\circ\text{C}$		570		ns
			$T_{vj} = 125 \text{ }^\circ\text{C}$		630		ns
			$T_{vj} = 150 \text{ }^\circ\text{C}$		650		ns
Rise time	t_r	$V_{CC} = 900 \text{ V}$, $I_C = 1600 \text{ A}$, $R_G = 0.9 \text{ } \Omega$, $C_{GE} = 0 \text{ nF}$, $V_{GE} = \pm 15 \text{ V}$, $L_S = 75 \text{ nH}$, inductive load	$T_{vj} = 25 \text{ }^\circ\text{C}$		250		ns
			$T_{vj} = 125 \text{ }^\circ\text{C}$		260		ns
			$T_{vj} = 150 \text{ }^\circ\text{C}$		260		ns
Turn-off delay time	$t_{d(off)}$	$V_{CC} = 900 \text{ V}$, $I_C = 1600 \text{ A}$, $R_G = 0.9 \text{ } \Omega$, $C_{GE} = 0 \text{ nF}$, $V_{GE} = \pm 15 \text{ V}$, $L_S = 75 \text{ nH}$, inductive load	$T_{vj} = 25 \text{ }^\circ\text{C}$		950		ns
			$T_{vj} = 125 \text{ }^\circ\text{C}$		1060		ns
			$T_{vj} = 150 \text{ }^\circ\text{C}$		1100		ns
Fall time	t_f	$V_{CC} = 900 \text{ V}$, $I_C = 1600 \text{ A}$, $R_G = 0.9 \text{ } \Omega$, $C_{GE} = 0 \text{ nF}$, $V_{GE} = \pm 15 \text{ V}$, $L_S = 75 \text{ nH}$, inductive load	$T_{vj} = 25 \text{ }^\circ\text{C}$		200		ns
			$T_{vj} = 125 \text{ }^\circ\text{C}$		240		ns
			$T_{vj} = 150 \text{ }^\circ\text{C}$		260		ns
Turn-on switching energy	E_{on}	$V_{CC} = 900 \text{ V}$, $I_C = 1600 \text{ A}$, $R_G = 0.9 \text{ } \Omega$, $C_{GE} = 0 \text{ nF}$, $V_{GE} = \pm 15 \text{ V}$, $L_S = 75 \text{ nH}$, inductive load	$T_{vj} = 25 \text{ }^\circ\text{C}$		430		mJ
			$T_{vj} = 125 \text{ }^\circ\text{C}$		590		mJ
			$T_{vj} = 150 \text{ }^\circ\text{C}$		650		mJ
Turn-off switching energy	E_{off}	$V_{CC} = 900 \text{ V}$, $I_C = 1600 \text{ A}$, $R_G = 0.9 \text{ } \Omega$, $C_{GE} = 0 \text{ nF}$, $V_{GE} = \pm 15 \text{ V}$, $L_S = 75 \text{ nH}$, inductive load	$T_{vj} = 25 \text{ }^\circ\text{C}$		420		mJ
			$T_{vj} = 125 \text{ }^\circ\text{C}$		570		mJ
			$T_{vj} = 150 \text{ }^\circ\text{C}$		640		mJ
Short circuit current	I_{sc}	$t_{psc} \leq 10 \text{ } \mu\text{s}$, $V_{GE} = 15 \text{ V}$, $V_{CC} = 1200 \text{ V}$, $V_{CEM \text{ CHIP}} \leq 1700 \text{ V}$	$T_{vj} = 150 \text{ }^\circ\text{C}$		6600	A	

³⁾ Characteristic values according to IEC 60747 - 9

⁴⁾ Collector-emitter saturation voltage is given at chip level

Diode characteristic values ⁵⁾

Parameter	Symbol	Conditions	min	typ	max	Unit
Forward voltage ⁶⁾	V _F	I _F = 1600 A	T _{Vj} = 25 °C	1.65	1.95	V
			T _{Vj} = 125 °C	1.67	2	V
			T _{Vj} = 150 °C	1.6		V
Peak reverse recovery current	I _{RM}		T _{Vj} = 25 °C	1190		A
			T _{Vj} = 125 °C	1400		A
			T _{Vj} = 150 °C	1490		A
Recovered charge	Q _{rr}	V _{CC} = 900 V, I _F = 1600 A, V _{GE} = ±15 V, R _G = 0.9 W, C _{GE} = 0 nF, L _S = 75 nH, inductive load	T _{Vj} = 25 °C	490		μC
			T _{Vj} = 125 °C	840		μC
			T _{Vj} = 150 °C	1000		μC
Reverse recovery time	t _{rr}		T _{Vj} = 25 °C	720		ns
			T _{Vj} = 125 °C	1120		ns
			T _{Vj} = 150 °C	1220		ns
Reverse recovery energy	E _{rec}		T _{Vj} = 25 °C	310		mJ
			T _{Vj} = 125 °C	540		mJ
			T _{Vj} = 150 °C	640		mJ

⁵⁾ Characteristic values according to IEC 60747 - 15

⁶⁾ Forward voltage is given at chip level

Package properties ⁷⁾

Parameter	Symbol	Conditions	min	typ	max	Unit
IGBT thermal resistance junction to case	R _{th(j-c)IGBT}				0.011	K/W
Diode thermal resistance junction to case	R _{th(j-c)DIODE}				0.018	K/W
IGBT thermal resistance ²⁾ case to heatsink	R _{th(c-s)IGBT}	IGBT per switch, l grease = 1W/m x K		0.012		K/W
Diode thermal resistance ²⁾ case to heatsink	R _{th(c-s)DIODE}	Diode per switch, l grease = 1W/m x K		0.024		K/W
Comparative tracking index	CTI		600			
Module stray inductance	L _{G CE}			12		nH
Resistance, terminal-IGBT	R _{CC'+EE'}		T _C = 25 °C	0.082		mΩ
			T _C = 125 °C	0.113		
			T _C = 150 °C	0.120		
Resistance, terminal-Chopper Diode	R _{CC'+AA'}		T _C = 25 °C	0.165		mΩ
			T _C = 125 °C	0.225		
			T _C = 150 °C	0.240		

²⁾ For detailed mounting instructions refer to ABB Document No. 5SYA 2039

Mechanical properties ⁷⁾

Parameter	Symbol	Conditions	min	typ	max	Unit
Dimensions	L x W x H	Typical	130 x 140 x 38			mm
Clearance distance in air	d _a	according to IEC 60664-1 and EN 50124-1	Term. to base:	19		mm
			Term. to term:	19		
Surface creepage distance	d _s	according to IEC 60664-1 and EN 50124-1	Term. to base:	28.2		mm
			Term. to term:	28.2		
Mass	m			1210		g

⁷⁾ Package and mechanical properties according to IEC 60747 - 15

Electrical configuration

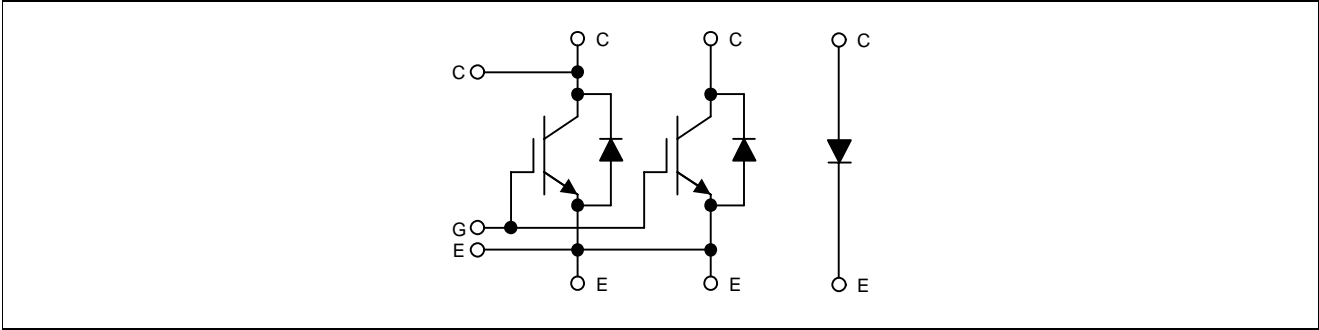

Outline drawing ²⁾

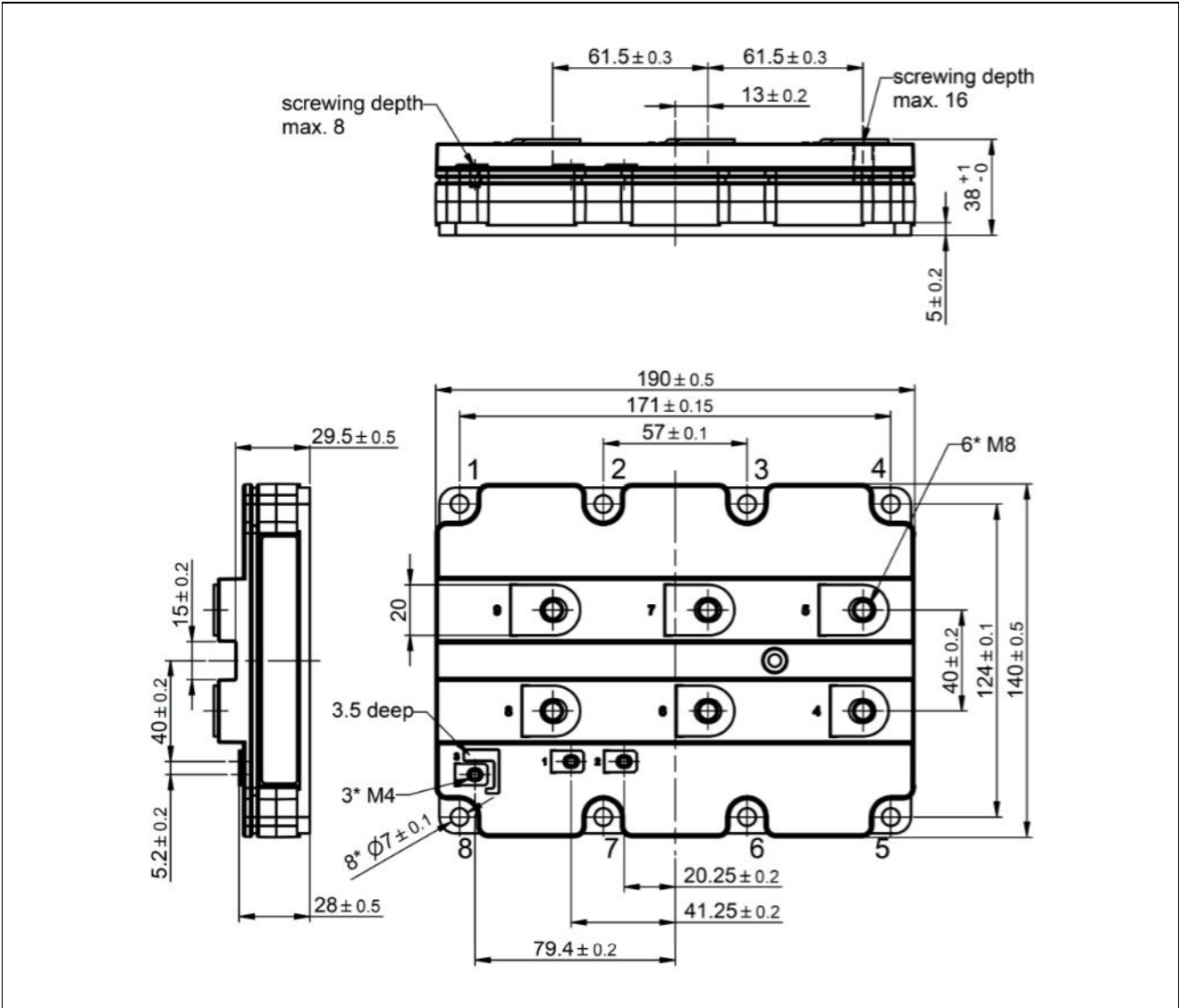

Note: all dimensions are shown in millimeters

²⁾ For detailed mounting instructions refer to ABB Document No. 5SYA 2039

This is an electrostatic sensitive device, please observe the international standard IEC 60747-1, chap. VIII.
This product has been designed and qualified for Industrial Level.

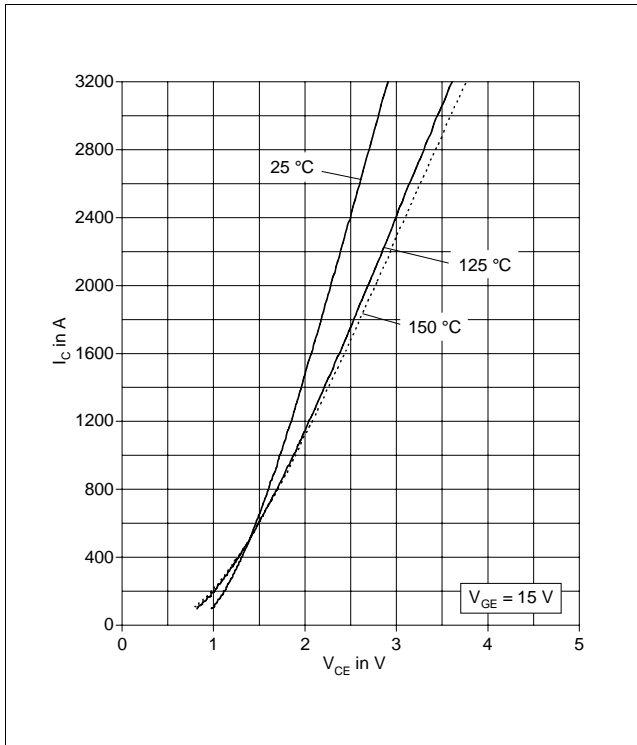

Fig. 1 Typical on-state characteristics, chip level

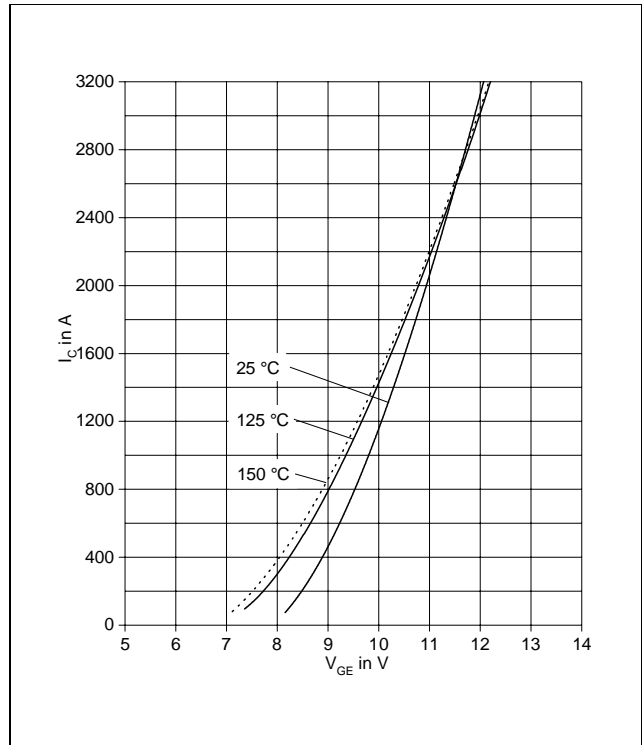

Fig. 2 Typical transfer characteristics, chip level

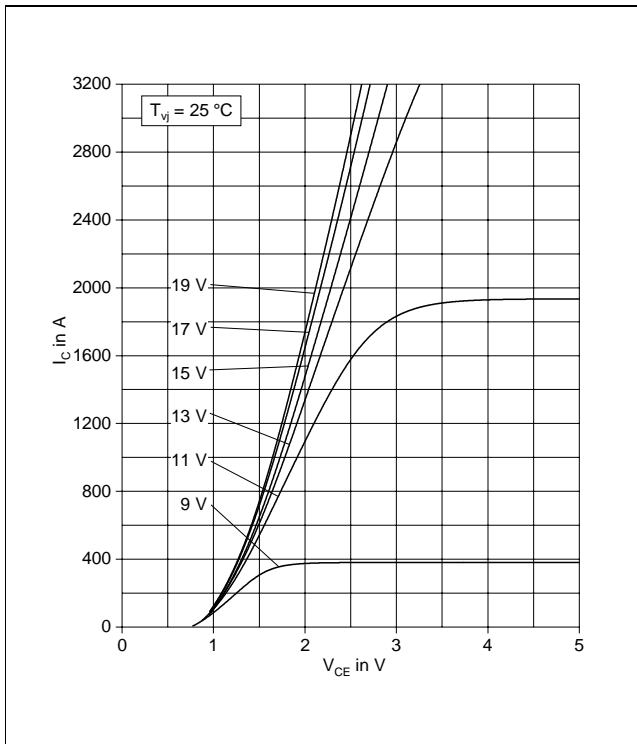

Fig. 3 Typical output characteristics, chip level

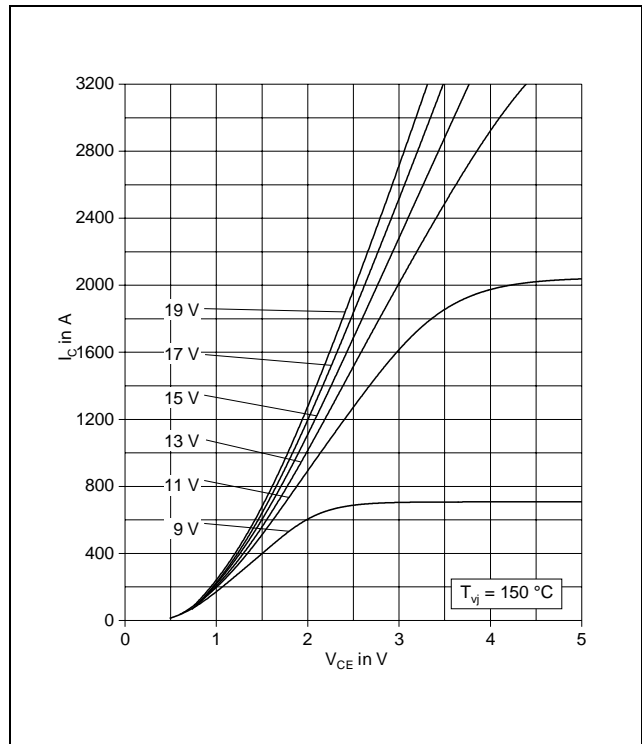

Fig. 4 Typical output characteristics, chip level

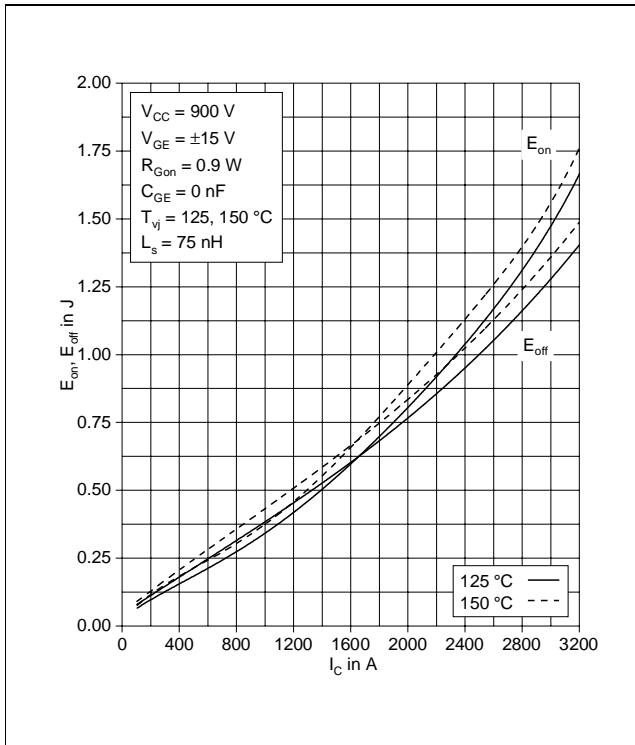

Fig. 5 Typical switching energies per pulse vs. collector current

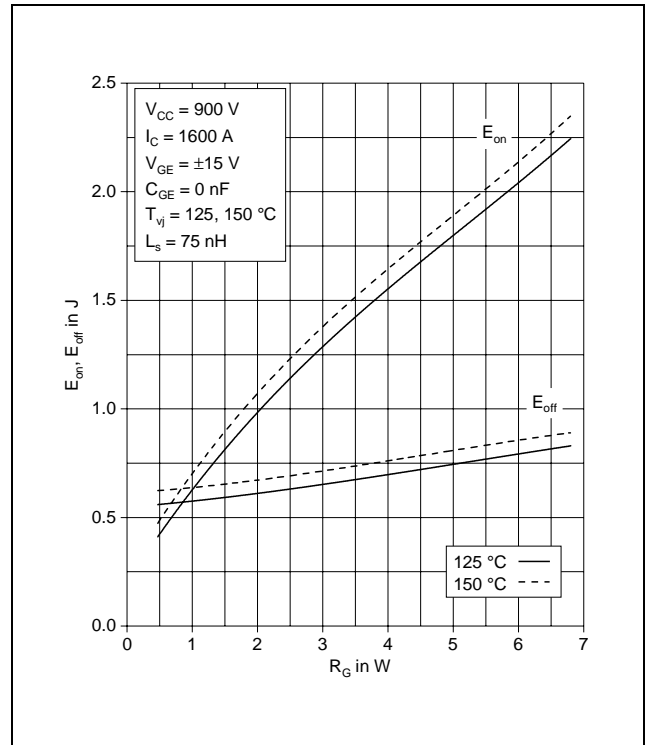

Fig. 6 Typical switching energies per pulse vs. gate resistor

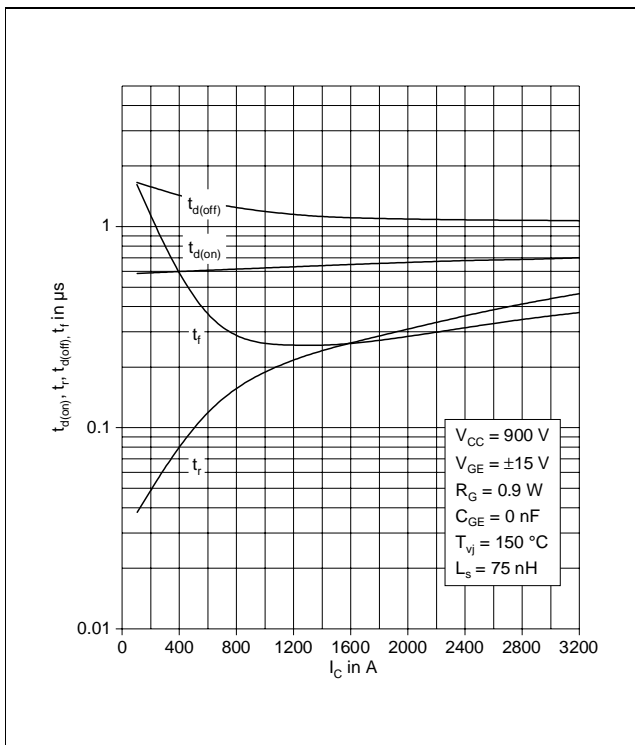

Fig. 7 Typical switching times vs. collector current

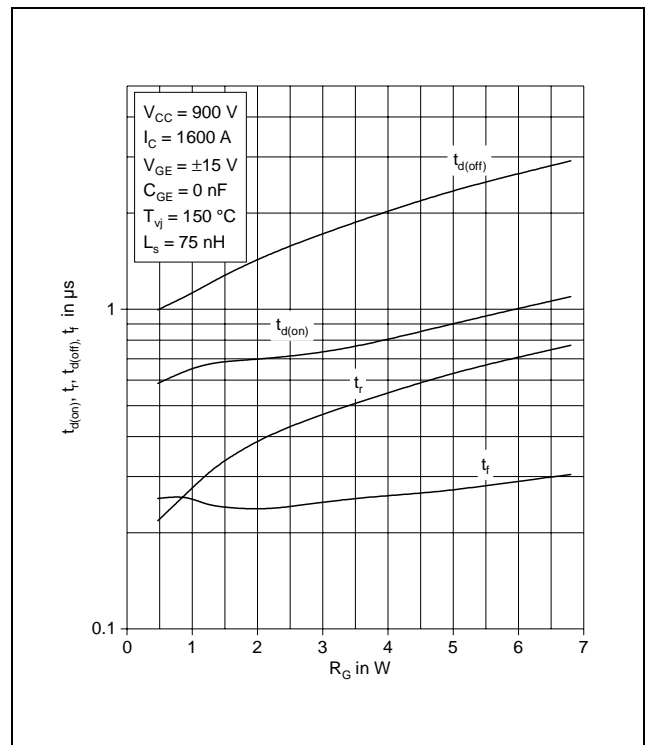

Fig. 8 Typical switching times vs. gate resistor

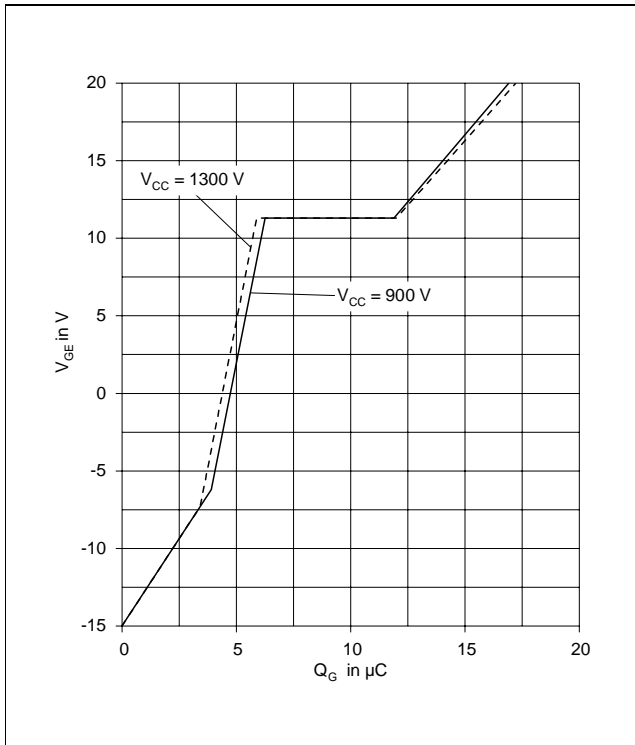

Fig. 9 Typical gate charge characteristics

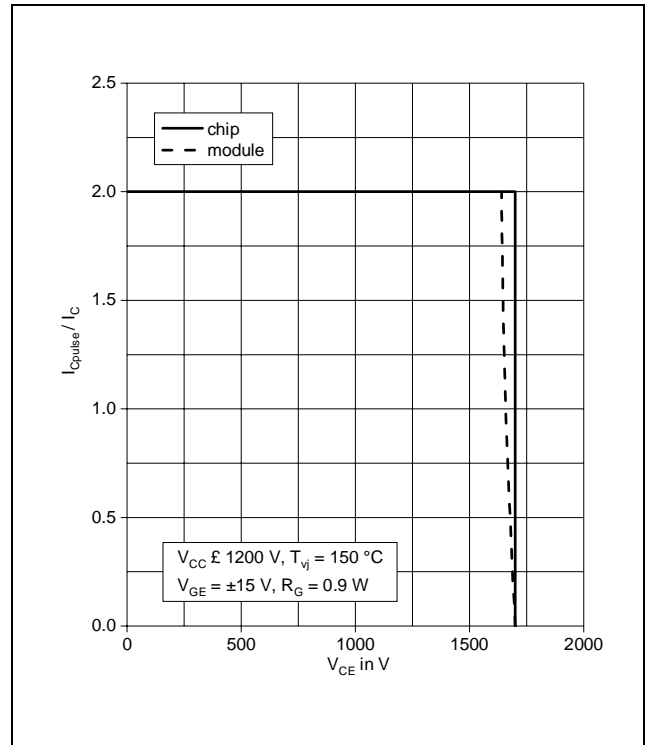

Fig. 10 Turn-off safe operating area (RBSOA)

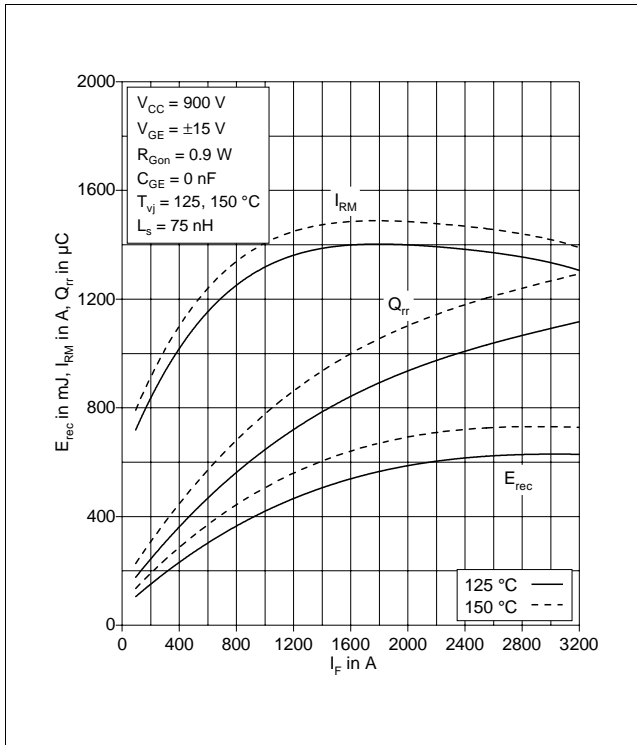

Fig. 11 Typical reverse recovery characteristics vs. forward current

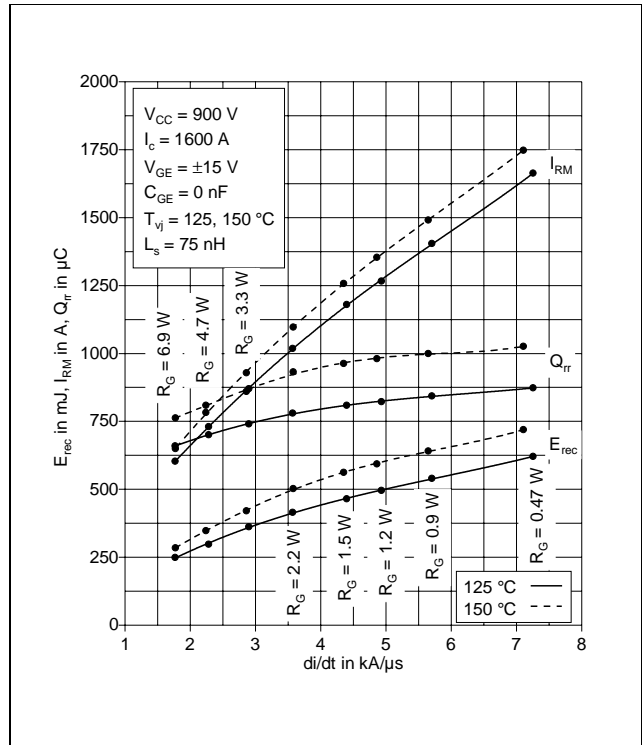

Fig. 12 Typical reverse recovery characteristics vs. di/dt

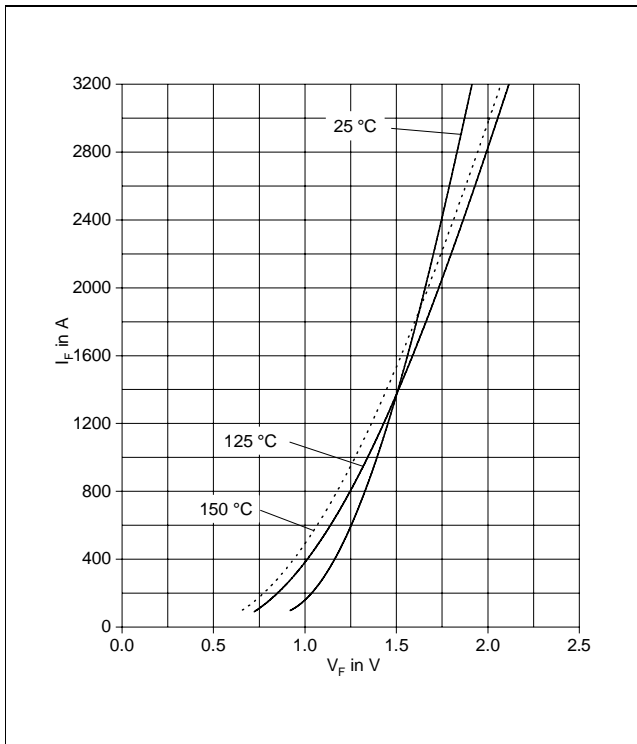

Fig. 13 Typical diode forward characteristics chip level

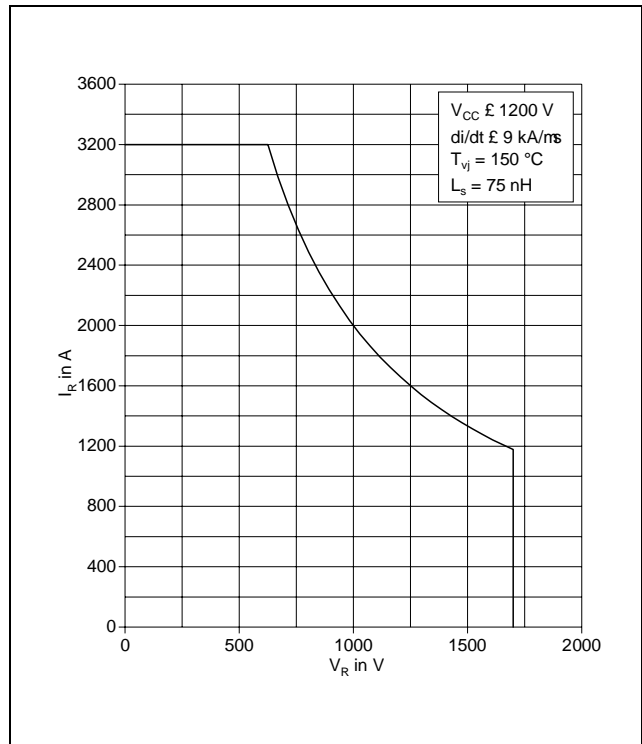

Fig. 14 Safe operating area diode (SOA)

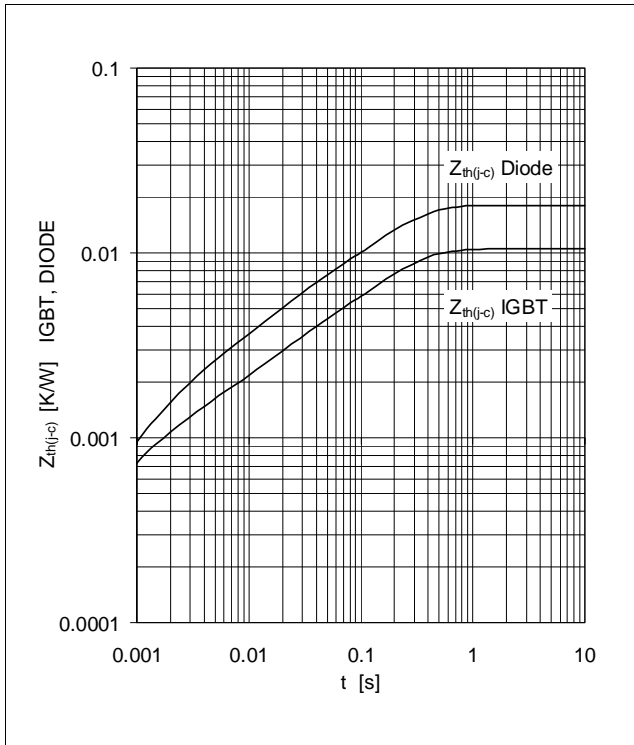

Fig. 15 Thermal impedance vs. time

Analytical function for transient thermal impedance:

$$Z_{th(j-c)}(t) = \sum_{i=1}^n R_i (1 - e^{-t/t_i})$$

i	1	2	3	4	5	
IGBT	Ri(K/kW)	7.59	1.8	0.743	0.369	
	ti(ms)	202	20.3	2.01	0.52	
DIODE	Ri(K/kW)	12.6	2.89	1.3	1.26	
	ti(ms)	210	29.6	7.01	1.49	

Related documents:

- 5SYA 2042 Failure rates of HiPak modules due to cosmic rays
- 5SYA 2043 Load - cycle capability of HiPaks
- 5SYA 2045 Thermal runaway during blocking
- 5SYA 2053 Applying IGBT
- 5SYA 2057 IGBT diode safe operating area (SOA)
- 5SYA 2058 Surge currents for IGBT diodes
- 5SYA 2093 Thermal design of IGBT modules
- 5SYA 2098 Paralleling of IGBT modules
- 5SYA 2039 Mounting Instructions for HiPak modules
- 5SZK 9111 Specification of environmental class for HiPak Storage
- 5SZK 9112 Specification of environmental class for HiPak Transportation
- 5SZK 9113 Specification of environmental class for HiPak Operation (Industry)
- 5SZK 9120 Specification of environmental class for HiPak

ABB Switzerland Ltd.
 Semiconductors
 Fabrikstrasse 3
 CH-5600 Lenzburg
 Switzerland

Phone: +41 58 586 1419
 Fax: +41 58 586 1306
 E-Mail: abbsem@ch.abb.com
 Internet: www.abb.com/semiconductors

We reserve the right to make technical changes or to modify the contents of this document without prior notice.
 We reserve all rights in this document and the information contained therein. Any reproduction or utilization of this document or parts thereof for commercial purposes without our prior written consent is forbidden.
 Any liability for use of our products contrary to the instructions in this document is excluded.

