

SURGE PROTECTIVE DEVICES

TG3™ 250 Surge Protection

TransGuard®



TransGuard® TG3™ suppression filter systems feature a powerful failure-free ISM™ (Integrated Suppression Module). The ISM™ contains individual thermally fused and protected MOVs, surge-rated copper busing, robust filtering and advanced remote communications capabilities. The TG3™ protects today's facilities from costly downtime and equipment damage caused by routine or catastrophic electrical disturbances.

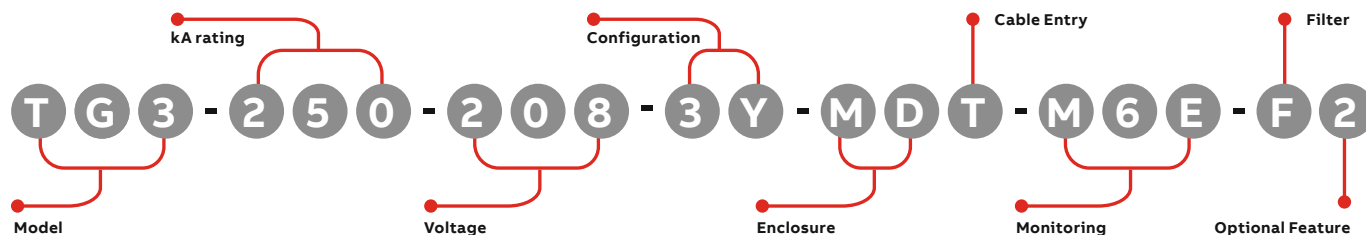

kA Rating	Voltage* (Consult factory for additional Voltages)		Configuration* (Consult factory for additional Configurations)		Enclosure
050	208	120/208	1G	1 Phase, Grounded	MN Metal Without Disconnect
080	240	120/240	2G	2 Phase, Grounded, Split Phase	MD Metal With Disconnect
100	380	220/380	3Y	3 Phase, Grounded Wye	SN Stainless Steel Without Disconnect
125	480	277/480	3H	3 Phase, Grounded, High Leg Delta	SD Stainless Steel With Disconnect
150	600	347/600	3D	3 Phase, Grounded Delta	PN Fiberglass Reinforced Polyester Without Disconnect
200					
250					
300					

*See table on back for more Voltage/Configuration Options.

Cable Entry		Monitoring		Filter		Optional Features		Stand-Alone Options (To Be Ordered As Separate Items)	
T	Top Feed	M0	No local monitoring (see remote MxX stand-alone option)	F	Filter	2	Test Port	DTS	DTS-2 Diagnostic Test Set
B	Bottom Feed	M1	Smart switching tri-color/LED/Phase, Audible Alarm & Dry Relay Contacts	N	No Filter			MxX	Remote Monitor Extension M1X through M6EX
		M2	M1 + Surge Counter					HPI	HPI Cable
		M3	Advanced Monitoring, Character Display, Modbus RTU						
		M4E	M3 + Ethernet, Modbus TCP						
		M5	Advanced Monitoring, Graphics Display, Modbus RTU						
		M6E	M5 + Ethernet, Modbus TCP						

Product Specifications

General Specifications

Maximum Surge Current Rating	250kA Per Mode, 500kA Per Phase
Nominal Discharge Surge Current	I-n = 20kA
Safety Listings	UL Listed 1449 4th Edition for Type 1 and Type 2 SPD applications, cUL, and UL 1283 / Meets Requirements for UL 96A / Compliant to IEEE C62.41.1-2002, C62.41.2-2002 and C62.45-2002 / NFPA 70 [NEC], Article 285 / RoHS Compliant
Protection Method	Thermally protected MOVs, Capacitive Filter
Product Design	Individual thermally fused and protected MOVs, and All Copper, Tin-plated Bus
Dimensions	Metal/Stainless Steel: 24"H x 16"W x 9.2"D Fiberglass Reinforced Polyester: 16.75"H x 14.75"W x 6"D
Weight	Metal/Stainless Steel: 50 lbs. Fiberglass Reinforced Polyester: 23 lbs.
Enclosure Type	NEMA 4/12 Standard (NEMA 4X Option)
Installation Location	Outdoor or Indoor
Operating Environment	-25°C to +60°C 5% – 95% Non-Condensing Humidity
Fault Current (SCCR)	200kAIC
Connection Method	Parallel
Protection Modes	All Modes (L-N, L-G, N-G, L-L)
Response Time	< 0.5 Nanoseconds
Operating Frequency	47 – 63 Hz
Warranty	15 Years

Filtering Attenuation Frequencies (Per Mil-Std-220B January 2000)**

10 KHz	100 KHz	1 MHz	10 MHz	Max at 142 KHz
18.1 dB	44 dB	22.8 dB	15.3 dB	54.6 dB

Single/Repetitive Surge Current Capacities (Tested)**

Protection Mode	Single Pulse Surge Current Capacity/Mode	Repetitive Surge Current Capacity/Mode
Line-to-Neutral	250,000A	10,000 Impulses
Line-to-Ground	250,000A	10,000 Impulses
Neutral-to-Ground	250,000A	10,000 Impulses
Line-to-Line	500,000A	20,000 Impulses
Per Phase	500,000A	20,000 Impulses

** Data based on actual tests. Contact factory for test reports

Maximum Continuous Operating Voltage (MCOV)

Voltage	L-N MCOV	Voltage	L-L MCOV
120V	150V	240V	300V
277V	320V	480V	552V
347V	420V	600V	690V

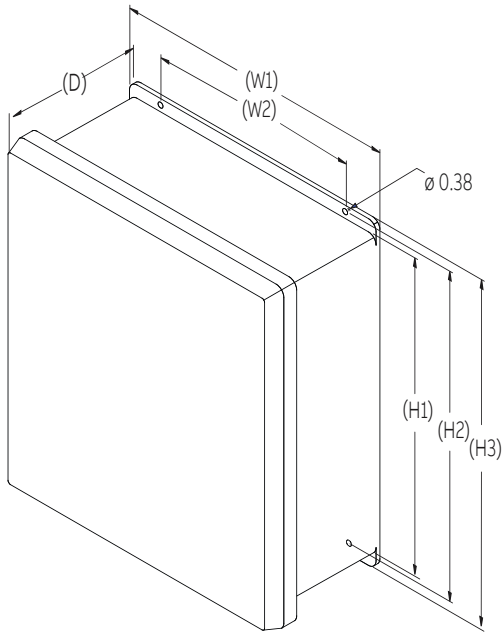
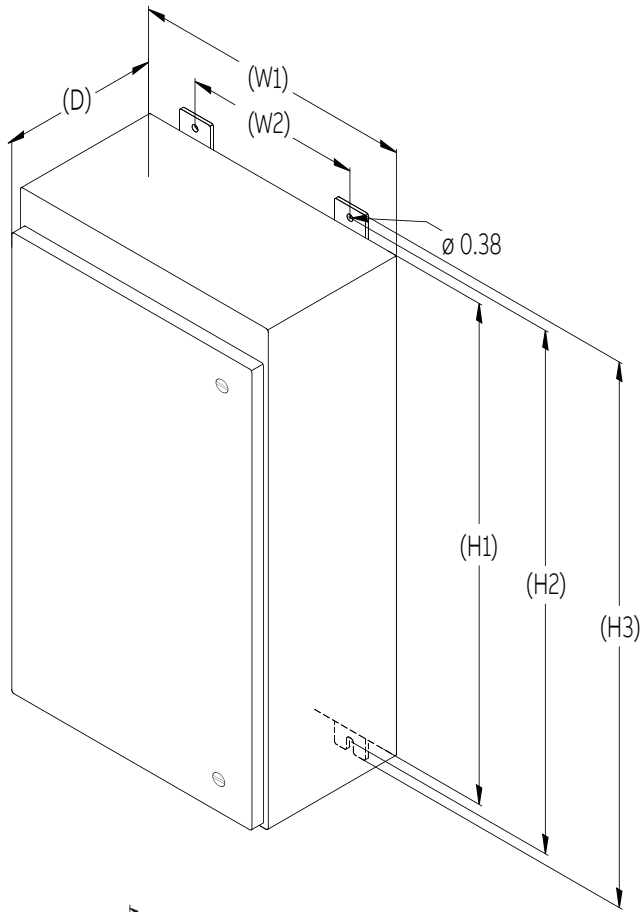

Dimensional specifications

Metal/Stainless Steel

TG3™/250	Inches	(mm)
H1	24.00	(609.6)
H2	25.25	(641.4)
H3	26.50	(673.1)
W1	16.00	(406.4)
W2	10.00	(254.0)
D	9.20	(233.7)

Fiberglass Reinforced Polyester

TG3™/250	Inches	(mm)
H1	16.75	(425.5)
H2	16.75	(425.5)
H3	17.50	(444.5)
W1	14.75	(374.7)
W2	12.00	(304.3)
D	6.67	(169.4)

Voltage/configuration options

Not all voltage configurations are displayed, contact your local sales representative for additional configurations.

	1-Phase, Grounded	2-Phase, Grounded, Split-Phase	3-Phase, Grounded, Wye	3-Phase, Grounded, High-Leg Delta	3-Phase, Grounded, Delta
	1G	2G	3Y	3H	3D

Voltage Configuration

120	X				
208	X		X		X
220	X	X			X
230	X				X
240	X	X		X	X
380		X	X		X
415		X	X		X
480		X	X		X
600		X	X		X

TG3™/250 performance data

System Voltage	120/240V or 120/208V				277/480V				347/600V				480V Delta			
Protection Mode	L-N	L-G	N-G	L-L	L-N	L-G	N-G	L-L	L-N	L-G	N-G	L-L	L-G	L-L		
MCOV	150	150	150	300	320	320	320	552	420	420	420	690	552	552		
B3 Ring Wave 6kV, 500A	490	570	640	500	450	540	570	530	490	520	600	550	1450	530		
B3/C1 Combo Wave 6kV, 3kA	614	629	634	1011	1013	1031	950	1857	1197	1219	1175	2369	1542	1857		
C3 Combo Wave 20kV, 10kA	980	980	1170	1600	1420	1540	1600	2600	1670	1670	1730	2980	2270	2600		
UL 1449 4th Edition VPR 6kV, 3kA	700	700	700	1200	1200	1200	1000	2000	1200	1500	1200	2500	1800	2000		

All TG3™ systems voltage protection ratings (VPR) are peak values (±10%) measured from the 90° reference point and are in compliance with test and evaluation procedures outlined in ANSI/IEEE C62.41



ABB Inc.
860 Ridge Lake Blvd.
Memphis, TN 38120
USA

We reserve the right to make technical changes or modify the contents of this document without prior notice. With regard to purchase orders, the agreed particulars shall prevail. ABB Inc. does not accept any responsibility whatsoever for potential errors or possible lack of information in this document

We reserve all rights in this document and in the subject matter and illustrations contained therein. Any reproduction, disclosure to third parties or utilization of its contents – in whole or in parts – is forbidden without prior written consent of ABB Inc. Copyright © 2021 ABB