

White paper

Protection against electric arc Integration between Arc Guard System™ (TVOC-2) and Emax air-circuit breakers

Protection against electric arc Integration between Arc Guard System™ (TVOC-2) and Emax air-circuit breakers

Index

1. Introduction.....	2
2. The electric arc.....	3
2.1. Electric arc phenomenon.....	3
2.2. Effects of the electric arc inside switchgear and controlgear assemblies	3
2.3. Effects of the electric arc on human beings	4
3. Assemblies equipped with devices limiting internal arc effects (active protection concept)	5
4. Application example.....	14

1. Introduction

In the last years a lot of users have underlined the question of safety in electrical assemblies with reference to one of the most severe and destructive electro-physical phenomenon: the electric arc.

Such phenomenon generates internal overpressures and results in local overheatings which may cause high mechanical and thermal stresses in the equipment.

Arc accidents can happen due to several reasons, such as human mistakes, bad connections, animals etc. Most often the accident occurs when someone is working in the switchgear for maintenance or installation. This is normally performed with an open cabinet door. Since the cabinet door is open the protection of arc-proof switchgear design will be significantly decreased. The arc guard system is therefore a

natural part of a modern switchgear design.

Luckily accidents are quite unusual, but when they happen the consequences are often severe, resulting in heavy injuries or death. This is many times combined with long downtimes and destroyed equipment. For this reason it is crucial to build up a robust safety solution that works every time.

The purpose of this document is giving the necessary explanations for the correct use and proper integration between the new Arc Guard by ABB TVOC-2, a device which can detect an electric arc thanks to the optical sensors, and ABB SACE circuit-breakers.

This document is not aimed at dealing with the concept of internal arc-proof assemblies but at describing an active protection system used to limit the effects of the internal arc.

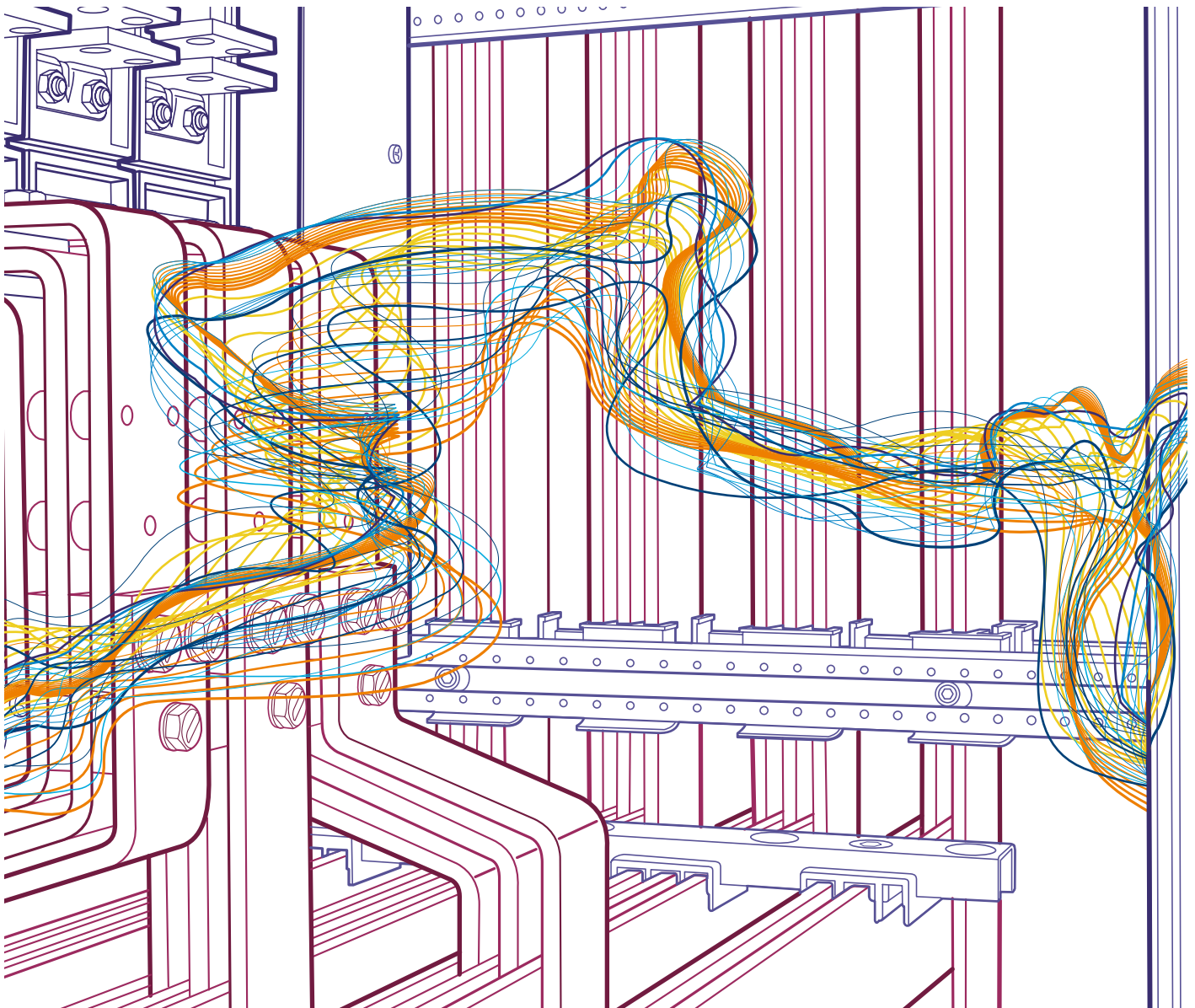

2. The electric arc

2.1 Electric arc phenomenon

The electric arc is a phenomenon that takes place as a consequence of a discharge. This occurs when the voltage between two points exceeds the insulating strength limit of the interposed gas. In the presence of suitable conditions, a plasma is generated which carries the electric current till the opening of the protective device on the supply side. Gases, which are good insulating means under normal conditions, may become current conductors in consequence of a change in their chemical-physical properties due to a temperature rise or to other external factors.

To understand how an electric arc originates, reference can be made to what happens when a circuit opens or closes. During the opening phase of an electric circuit the contacts of the protective device start to separate thus offering to the current a gradually decreasing section; therefore the current meets growing resistance with a consequent rise in the temperature. As soon as the contacts start to separate, the electric field applied to the circuit exceeds the dielectric strength of the air, causing its perforation through a discharge.

The high temperature causes the ionization of the surrounding air which keeps the current circulating in the form of electric arc. Besides thermal ionization, there is also an electron emission from the cathode due to thermoionic effect. The ions, formed in the gas and by collision due to the very high temperature, are accelerated by the electric field, strike the cathode, release energy in the collision thus causing a localized heating which generates electron emission.

The electric arc lasts till the voltage at its ends supplies the energy sufficient to compensate for the quantity of heat dissipated and to maintain the suitable conditions of temperature. If the arc is elongated and cooled, the conditions necessary for its maintenance lack and it extinguishes. Analogously, an arc may originate also as a consequence of a short-circuit between phases. A short-circuit is a low impedance connection between two conductors at different voltages. The conducting element which constitutes the low impedance connection (e.g. a metallic tool forgotten on the busbars inside the enclosure, a wrong wiring or a body of an animal entered into the enclosure), is subject to the difference of potential and is passed through by a current of generally high value, depending on the characteristics of the circuit.

The flow of the high fault current causes the overheating of the cables or of the circuit busbars, up to the melting of the conductors of the lower section. As soon as a conductor melts, conditions occur that are similar to those present during the circuit opening. At that point an arc starts which lasts either till the protection devices intervene or till the conditions

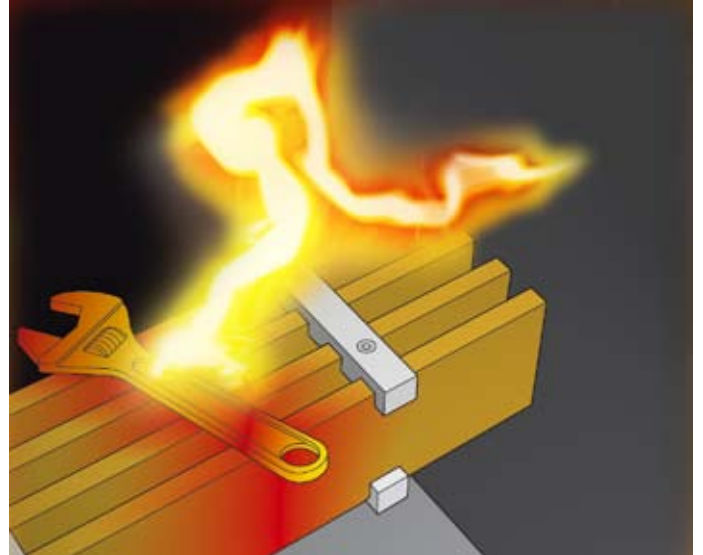

necessary for its stability subsist. The electric arc results are characterized by an intense ionization of the gaseous means, by reduced drop of the anodic and cathodic voltage (10 V and 40 V respectively), and by high or very high current density in the middle of the column (of the order of 10^2 - 10^3 up to 10^7 A/cm²). Also by very high temperatures (thousands of °C) always in the middle of the current column and – in low voltage - by a distance between the ends variable from some microns to some centimeters.



2.2 Effects of the electric arc inside switchgear and controlgear assemblies

In the proximity of the main boards, i.e. in the proximity of big electrical machines, such as transformers or generators, the short-circuit power is high and consequently also the energy associated with the electric arc due to a fault is high.

Without going into complex mathematical descriptions of this phenomenon, the first instants of arc formation inside a cubicle can be schematized in 4 phases:

1. compression phase: in this phase the air volume occupied by the arc is overheated owing to the continuous contribution of energy. Due to convection and radiation the remaining volume of air inside the cubicle warms up. Initially there are temperature and pressure values different from one zone to another;

2. The electric arc

2. expansion phase: from the first instants of internal pressure increase, a hole is formed through which the overheated air begins to flow out. In this phase the pressure reaches its maximum value and starts to decrease owing to the release of hot air;
3. emission phase: in this phase, due to the continuous contribution of energy by the arc, nearly all the air is forced out under a soft and almost constant overpressure;
4. thermal phase: after the expulsion of the air, the temperature inside the switchgear reaches almost that of the electric arc. Thus beginning this final phase which lasts till the arc is quenched, when all the metals and the insulating materials coming into contact undergo erosion with production of gases, fumes and molten material particles. Should the electric arc occur in open configurations, some of the described phases could not be present or could have less effect; however, there will be a pressure wave and a rise in the temperature of the zones surrounding the arc.

Here are some data to understand how dangerous it is being in the proximity of an electric arc:

- **pressure:** it has been estimated that at a distance of 60 cm from an electric arc associated with a 20 kA arcing fault a person is subject to a force of 225 kg; moreover, the sudden pressure wave may cause permanent injuries to the eardrum;
- **temperature:** an electric arc can reach about 7000-8000 °C;
- **sound:** electric arc sound levels can reach 160 db, a shotgun blast is only 130 db.

2.3 Effects of the electric arc on human beings

From the above, it is evident that the electric arc represents a hazard source for people and goods. The hazards to which a person is exposed due to the release of energy generated by an arc event are:

- inhalation of toxic gases;
- burns;
- injuries due to ejection of materials;
- damages to hearing.



Inhalation of toxic gases

The fumes produced by burnt insulating materials and by molten or vaporized metals can be toxic. The fumes are caused by incomplete burning and are formed by carbon particles and by other solid substances suspended in the air.



Burns

The high temperature levels of the gases, produced by the electric arc, and the expulsion of incandescent metal particles may cause more or less severe burns to people.

Flames can cause all degrees of burn up to carbonization: the red-hot solid bodies, such as the metal fragments of the assembly involved, cause third degree burns, superheated steam causes burns analogous to those by hot liquids whereas radiant heat generally causes less severe burns.



Injuries due to ejection of materials

The ejection of loose parts caused by the electric arc can result in injuries to the most susceptible parts of the human body as, for example, the eyes. The materials expelled owing to the explosion produced by the arc may penetrate the cornea and damage it.

The extent of the resulting lesion depends on the characteristics and on the kinetic energy of these objects. Moreover, the ocular region can sustain injuries to the mucosa because of the gases released by the arc and the emission of ultraviolet and infrared rays can injure the cornea and the retina depending on the radiation wavelengths.



Damages to hearing

As already mentioned, the electric arc manifests itself as a real explosion, whose sound may cause permanent injuries to hearing.

3. Assemblies equipped with devices limiting internal arc effects (concept of active protection)

Safety for the operator and for the installation in case of arcing inside LV switchgear can be obtained through three different design philosophies:

1. assemblies mechanically capable of withstanding the electric arc (passive protection)
2. assemblies equipped with devices limiting the effects of internal arcing (active protection)
3. assemblies equipped with current limiting circuit-breakers.

These three solutions (also combined together) have found a remarkable development in the industrial field and have been successfully applied by the main manufacturers of LV switchgear and controlgear assemblies.

In the following pages we focus on the devices limiting internal arc effects, that are on active protection. However, it must be kept in mind that an active protection, in comparison with a passive one, is intrinsically more complex due to the presence of additional electromechanical/electronic devices which can be subject to faults or tripping failures.

With active protection it is meant to guarantee the resistance to internal arcing by installing devices limiting the arc.

The possible approaches can be of two types:

- limiting the destructive effects of the arc, once it has occurred, by means of overpressure detectors.
- limiting the destructive effects of the arc, once it has occurred, by means of bright arc detectors (Arc Guard System TVOC-2)

The first possibility consists in installing in the assembly arc detectors which sense overpressure.

As already specified the overpressure wave is one of the other

effects occurring inside an assembly in case of arcing.

As a consequence it is possible to install some pressure sensors which are able to signal the pressure peak associated with the arc ignition with a delay of about 10 to 15 ms. This signal operates on the supply circuit-breaker without waiting for the trip times of the selectivity protections to elapse, which are necessarily longer.

Such a system does not need any electronic processing device, since it acts directly on the shunt opening release of the supply circuit-breaker.

Obviously, it is essential that the device is set at fixed trip thresholds. When an established internal overpressure is reached, the arc detector intervenes.

However, it is not easy to define in advance the value of overpressure generated by an arc fault inside a switchboard.

The second possibility consists in installing in the assembly, detectors which sense the light flux associated with the electric arc phenomenon (arc detectors).

The operating logic of an arc detector is the following: the occurrence of an arc inside the switchboard is detected by the arc detector because an intense light radiation is associated with this phenomenon. The arcing control system detects the event and sends a tripping signal to the circuit-breaker. In this case the reaction time of the detection is about 1 ms

Figure 1 shows the possible installation areas where this device can be positioned inside a switchboard. The ideal solution is to provide the installation with at least one detector for each column, with the consequent reduction to a minimum of the length of the optical fibers carrying the signal.

Figure 1



Example showing the position of detectors in:
1. Horizontal and vertical bus bar system
2. Circuit-breaker cubicle

3. Assemblies equipped with devices limiting internal arc effects (concept of active protection)

In cases where the detectors can be exposed to an intensive light (camera flash, direct sunlight etc.), an additional current sensor can be positioned at the incoming of the main circuit-breaker.

This unit adds a current condition to the system. In the event of an arc, both the current sensing unit - which detects an "anomalous" current due to the arc fault - as well as the sensor detecting the light radiation associated with the arc enables the system to intervene and allow the consequent opening of the circuit-breaker.

Figure 2: current sensing unit

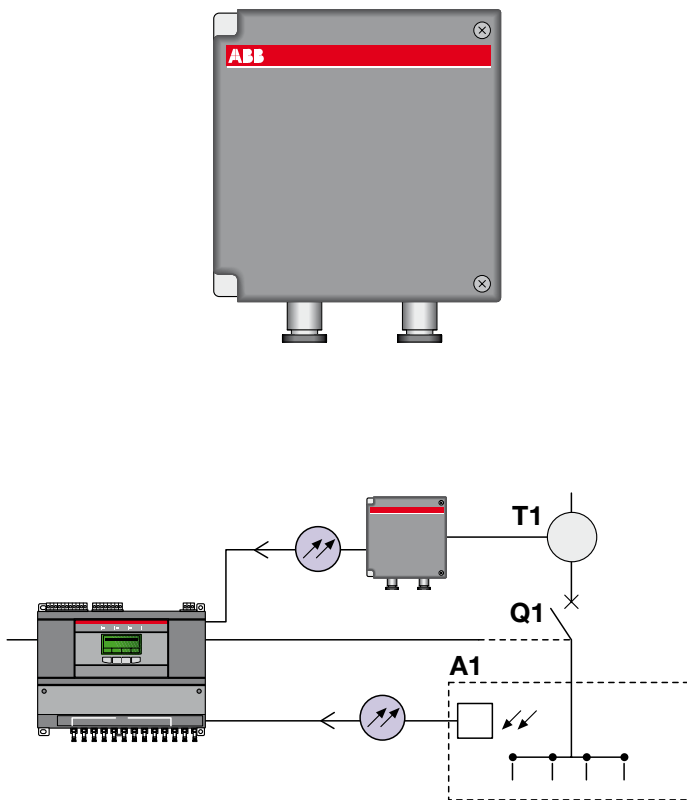

The tripping time of this system, which consists mainly of the circuit-breaker and of the unit TVOC-2, is a few milliseconds. It by-passing the tripping of the overcurrent release of the circuit-breaker, which – for example – could be delayed because of different installation necessities, among which:

1. selectivity requirement;
2. connections of capacitor banks
3. electrical components with high inrush currents.

Now let us see in details why it is necessary to delay the tripping times in the above mentioned applications.

Selectivity requirement

One of the techniques used to obtain selectivity between circuit-breakers is to increase progressively the current thresholds and the trip delays that are closer to the power supply sources. In this way a given value of short-circuit (or overload) current will make the protections on the supply side trip after a defined time delay. For example, to allow any protection placed closer to the fault to trip, excluding the area of occurrence of the fault. It is evident that the circuit-breakers on the supply side might have very high setting values for S (delayed short-circuit protection function) in terms of ms, as shown in the following example:

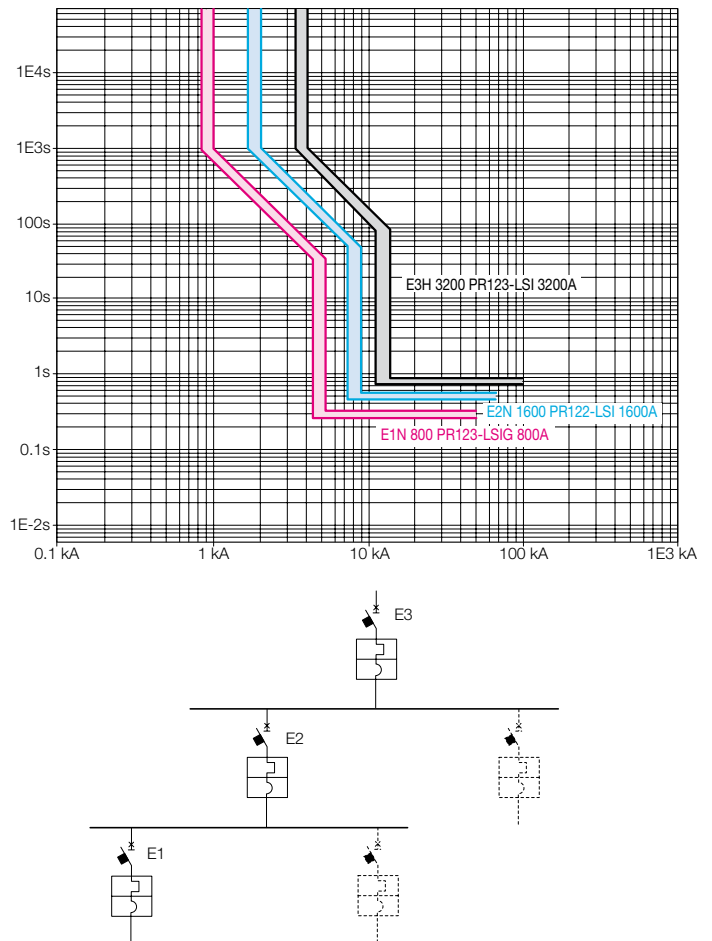

It is evident that the circuit-breaker E3, because of the number of circuit-breakers involved in the selectivity chain, shall have the instantaneous protection in OFF position (necessary to get downstream selectivity) and the delayed one relevant to the protection function S set at the maximum possible value (close to 1 second).

Connection of capacitor banks

The devices used for the protection of capacitor banks shall be sized taking into account that at the moment of connection there is an overcurrent at high frequency (in the first instants equivalent to a short-time short-circuit) this amplitude depends on the grid parameter on the supply side and on the capacitor bank.

For this reason the circuit-breaker, besides having an adequate breaking capacity shall have the instantaneous short-circuit protection set at the maximum value or even in OFF with protection S active and set with delayed times. Also in this case, as in that previously analyzed, under short-circuit conditions the tripping time depends on the setting of t₂ (tripping time of function S).

Electrical components with high inrush currents

This “category” includes all those electrical devices which to function at the connection instant absorb a current higher than the rated one.

As it is easy to understand, in order to avoid unwanted trips during the current absorption, in these cases too the circuit-breaker shall have the instantaneous protection excluded (protection in OFF) and protection S active, thus allowing the machine to start thanks to the delays set.

For example, this application typology includes lighting installations (incandescent lamps, fluorescent lamps, etc.) and large-size electrical motors, in which switching-protection and starting operations are managed by Emax CBs equipped with PR122-PR123.

Another example is the inrush current absorbed by the LV/ LV transformer on the primary side. Such current, which is necessary to magnetize the transformer windings, can reach up to 14 times the rated current.

The Arc Guard System detects the arcing event and sends the trip signal to the circuit-breaker. All with trip times of just a few milliseconds, by-passing the trip time of the overcurrent

release for all those applications in which - due to installation requirements – the trip units have delay time settings. The following Figure shows what above described with the Arc Guard System formed by a circuit-breaker equipped with the shunt opening release (SOR) and TVOC-2:

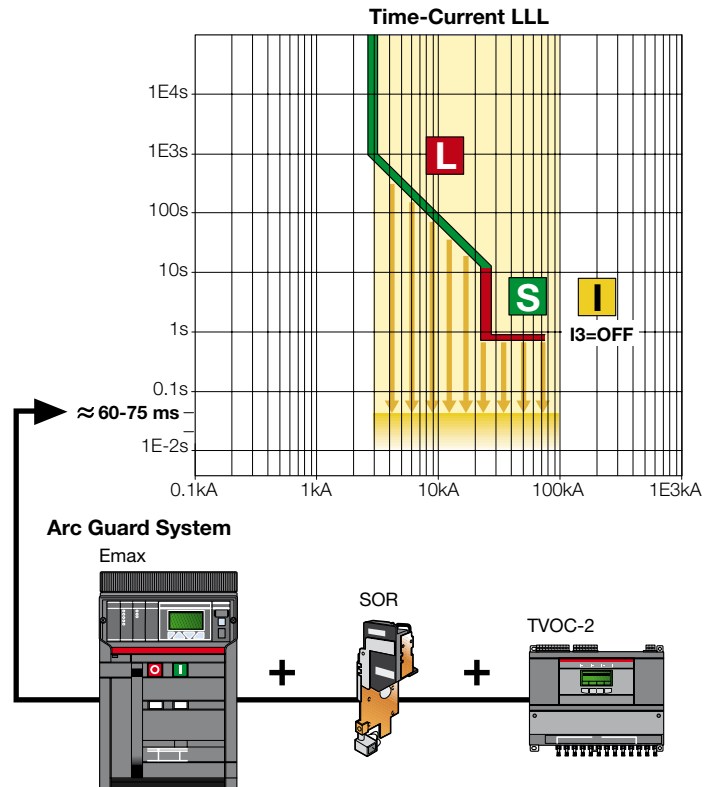

As regards the connection, it is necessary to connect the contact of the TVOC-2 to the terminals (K4) n.43-44 (or, as an alternative, (K5) n.53-54 or (K6) 63-64 in series with the shunt opening release (SOR) of the circuit-breaker (C11-C12 terminals).

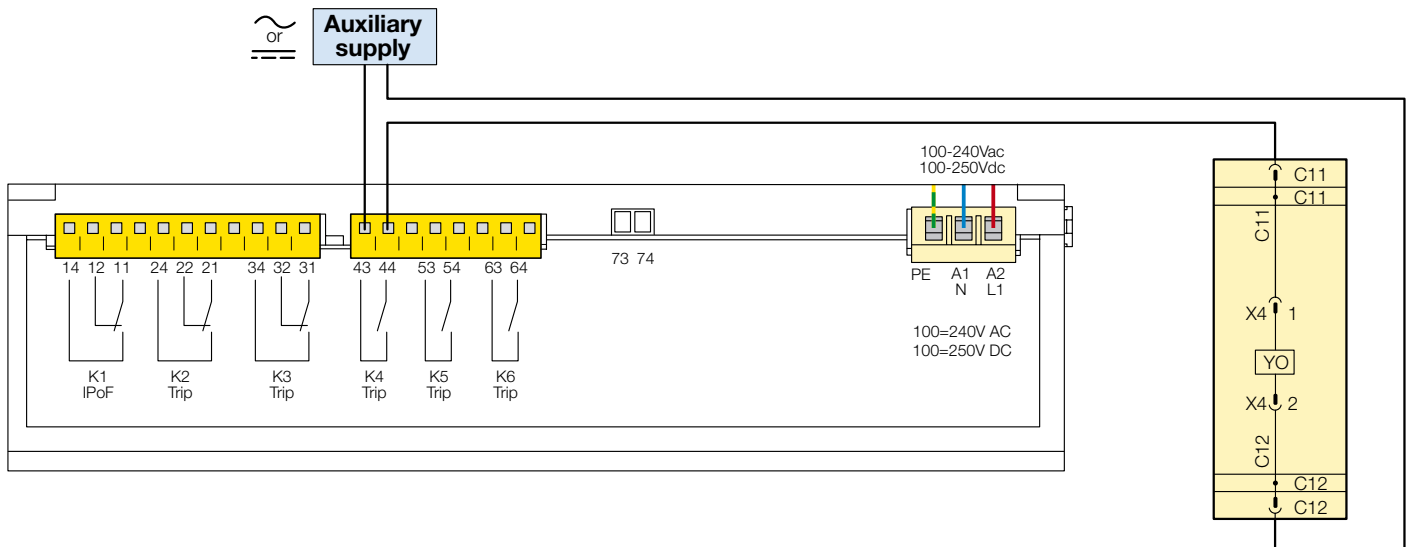

3. Assemblies equipped with devices limiting internal arc effects (concept of active protection)

To reduce this time (as previously said, the faster the time, the more efficient the system), with PR122/123 for Emax it is possible to use the internal module PR120/K. In fact, the contacts of this module can be configured and customized according to one's own requirements; in our case it is possible to associate the opening of the circuit-breaker to each 24Vdc signal arriving to the input contact of the module.

This alternative allows the total times to be remarkably reduced since, in this way, they no longer depend on the shunt opening release (SOR), but on the opening directly commanded by the electronic unit.

As regards the connection between the input contact of the module PR120/K and TVOC-2 reference shall be made to the example of page 15.

The following table shows the components and the relevant trip times according to the "technique" used (either with SOR or in case with PR120/K) as from the moment in which the light flux is detected to the moment when the circuit-breaker poles are in open position.

Circuit-breaker	Trip unit	Accessory	Arc monitor	Total time*
E1-E6	PR121/PR122/ PR123	SOR	TVOC-2	≈ 60-75ms
	PR122/PR123	PR120K		≈ 35-45ms

* the opening time depends on:
-the size of the circuit-breakers;
-the arc fault current.

As it can be noticed in the table, it is evident that the solution with the use of the module PR120/K reduces the total trip times and therefore it clearly represents a more efficient solution if compared with the traditional one with SOR (shunt opening release).

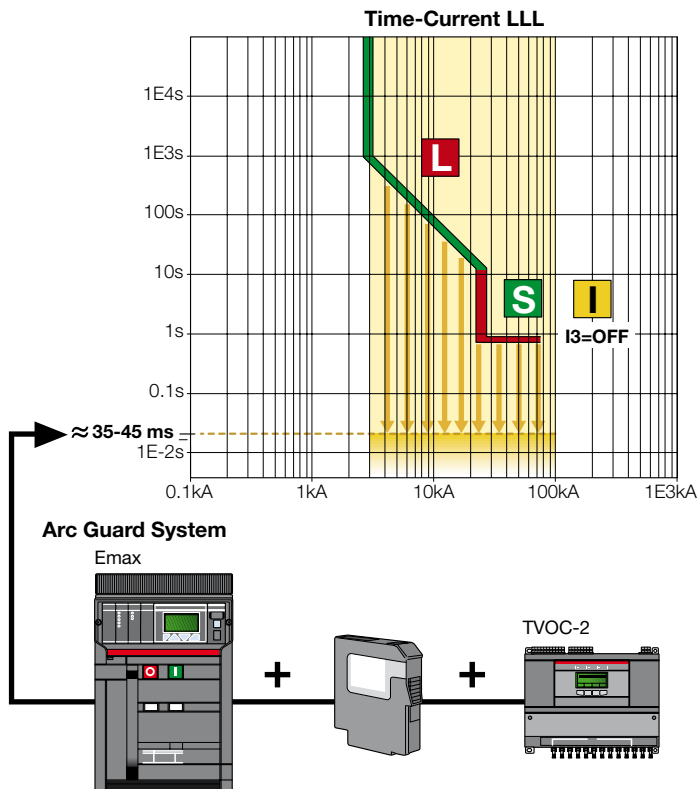

Examples of manageable operation logics

TVOC-2 can command up to three different circuit-breakers since it has the possibility of associating a defined number of light sensors to each circuit-breaker.

This makes it possible to use the arc monitor in all those applications in which due to different plant engineering reasons, in the event of an arc, it is not sufficient the opening of the main circuit-breaker (or even also of all the three circuit-breakers), but a logic strictly connected to the plant engineering configuration is required. The following pages report some examples of these applications trying to describe their operation logics.

As indicated in the previous pages, the Arc Guard System remarkably reduces the trip times in the event of an electric

Figure 3

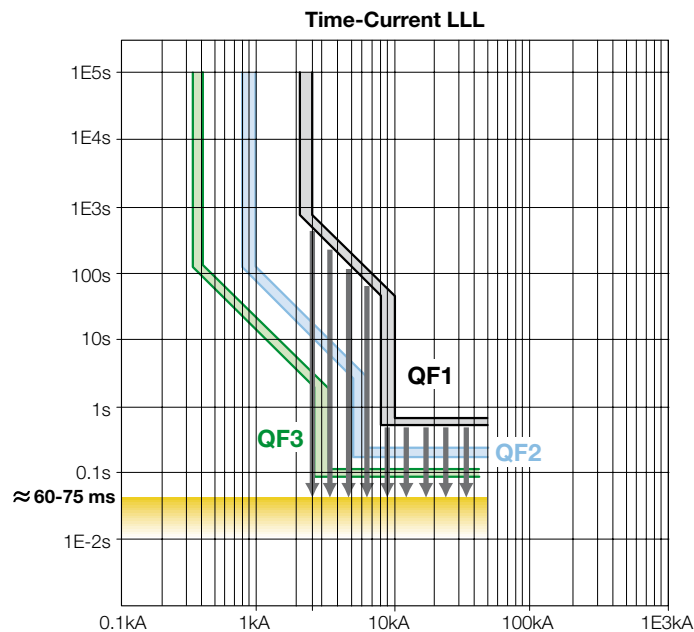

arc, above all by using the input digital contact of the module PR120/K. As a consequence, it is evident that under these conditions it is not possible to obtain selectivity in the event of internal arc even if the arc is on the load side of an outgoing feeder.

The following example illustrates the above.

Figure 3 shows the trip curves of three circuit-breakers, one on the supply side (QF1) selective with the two outgoing feeders (QF2-QF3). As it can be seen, since every light sensor commands the main circuit-breaker, in case of an internal arc, there will be a downtime for the whole plant.

Practically, it is as if the circuit-breaker on the supply side had a protection function which would make it instantaneous, thus making all the settings and time delays set according to the selectivity study useless.

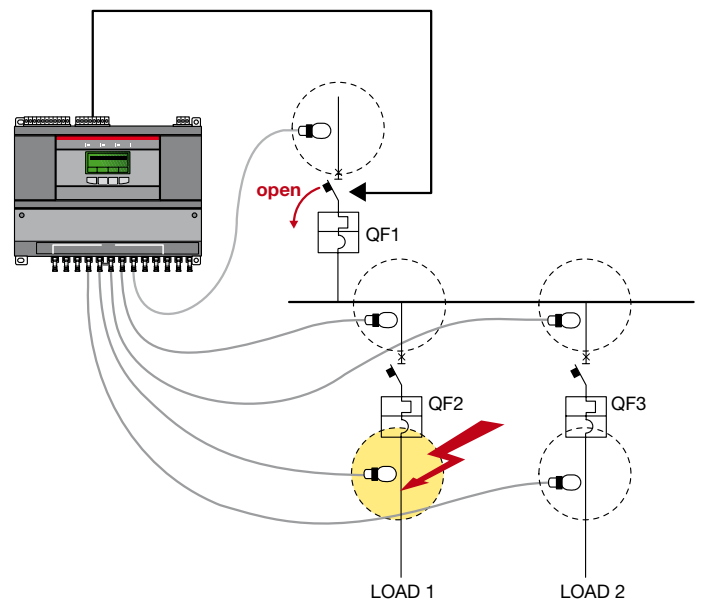

QF1: open → LOAD 1 and LOAD 2 **not supplied**

3. Assemblies equipped with devices limiting internal arc effects (concept of active protection)

In order to bypass such problem, when selectivity represents a fundamental aspect also under electric arcing conditions, it is possible to “exploit” the capacity to command up to three circuit-breakers through a single TVOC-2. This is done by assigning to each light sensor the task of opening one of the three of them; in this way the system is selective* also in the

event of an electric arc on the load side of an outgoing feeder (in the example on the load side of QF2).

The following figure illustrates the above (to simplify the example only 5 light sensors of the 30 available have been represented).

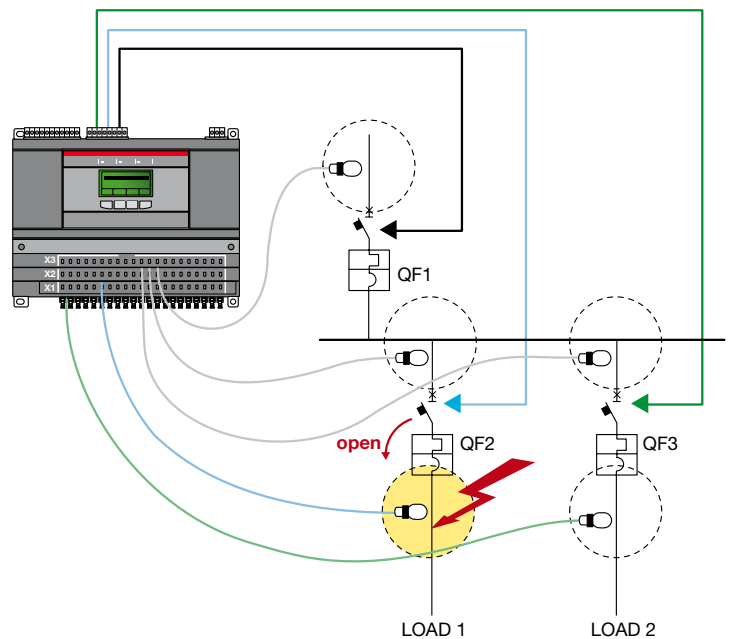
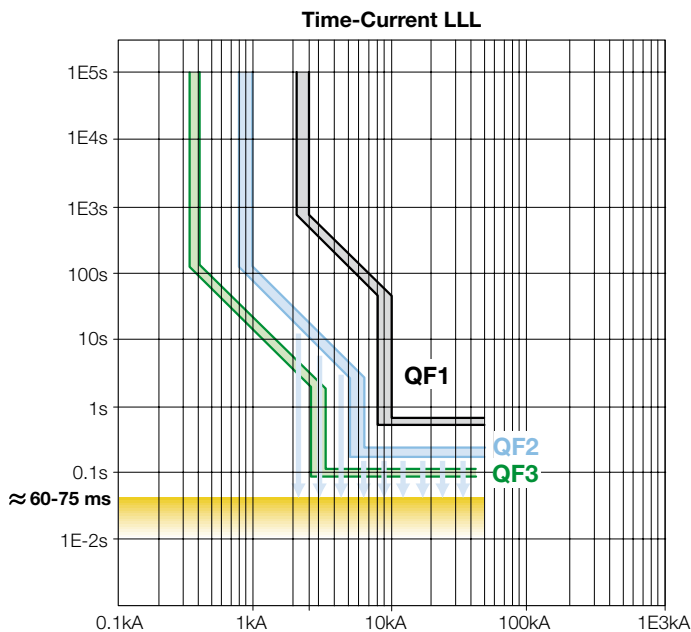

QF1 and QF3 closed: LOAD 2 **supplied**
QF2 opened



*It is evident that in order to get a selective system, each light sensor must not be influenced by the light fluxes which do not affect its area; in order to do so it is necessary that between the sensors some obstacles are present (typically the metal enclosure of the cubicles) as shown in the figure. Furthermore, the light sensors must be positioned in a “strategic” way (after a thorough analysis and not accidentally) to define the interest areas and the operating zones. This is made easier also by the fact that we are considering large power distribution switchboards in which the internal dimensions and the metalwork structure are such as to allow the separation of the sensors according to their relevant operating areas.

From an operational point of view:

To set this function on the arc monitor TVOC-2 it is necessary to position correctly the dip switches positioned on the left side of the arc monitor as shown in the following figure:

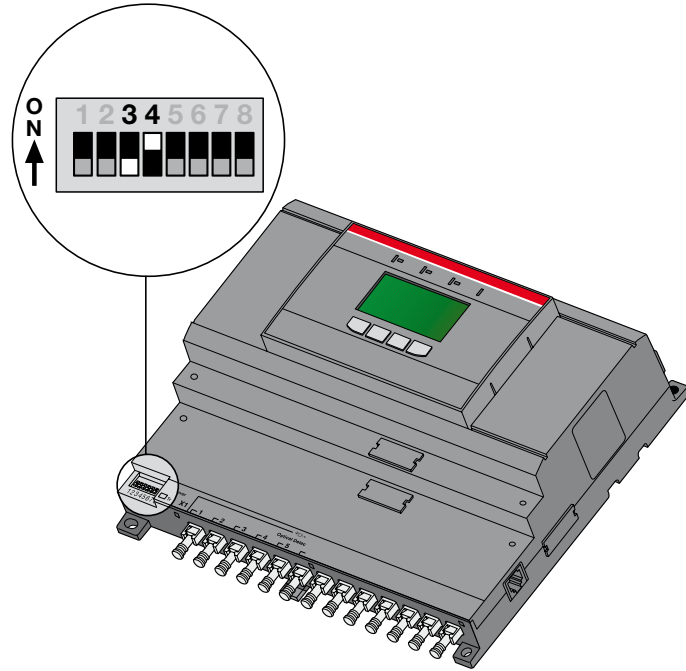

In this way, the TVOC-2 will make the circuit-breakers QF1-QF2-QF3 trip as follows:

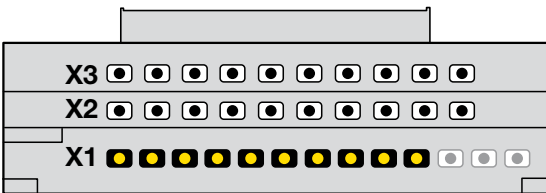
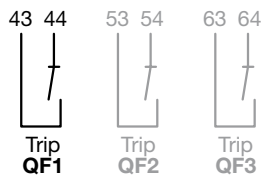

For each light signal detected by a light sensor belonging to the row of X1 detectors, TVOC 2 will command the tripping of QF1 circuit-breaker only

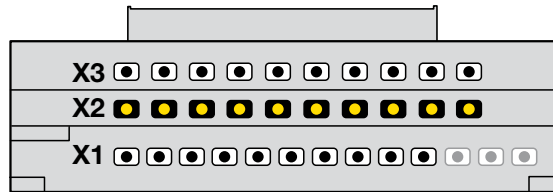
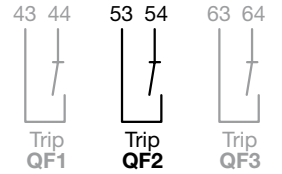

For each light signal detected by a light sensor belonging to the row of X2 detectors, TVOC 2 will command the tripping of QF2 circuit-breaker only

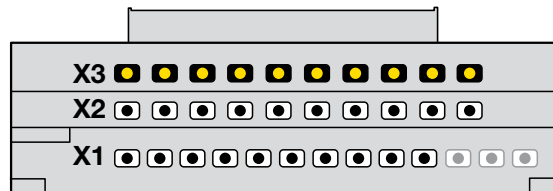
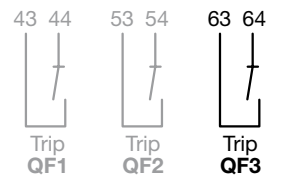

For each light signal detected by a light sensor belonging to the row of X3 detectors, TVOC 2 will command the tripping of QF3 circuit-breaker only

As regards the connections to be carried out between circuit-breaker and TVOC-2, reference must be made to the example on page 15.

3. Assemblies equipped with devices limiting internal arc effects (concept of active protection)

The figure below shows another application example in which – in this case – the simultaneous opening of three circuit-breakers is required.

As it can be seen from the figure, it is evident that in the event of an electric arc it is not sufficient to make only one circuit-

breaker open since the arc itself might be supplied by the other sources in parallel. In this case the opening of the three circuit-breakers represent a fundamental aspect (also in this case to simplify the example only 5 light sensors of the 30 available have been represented).

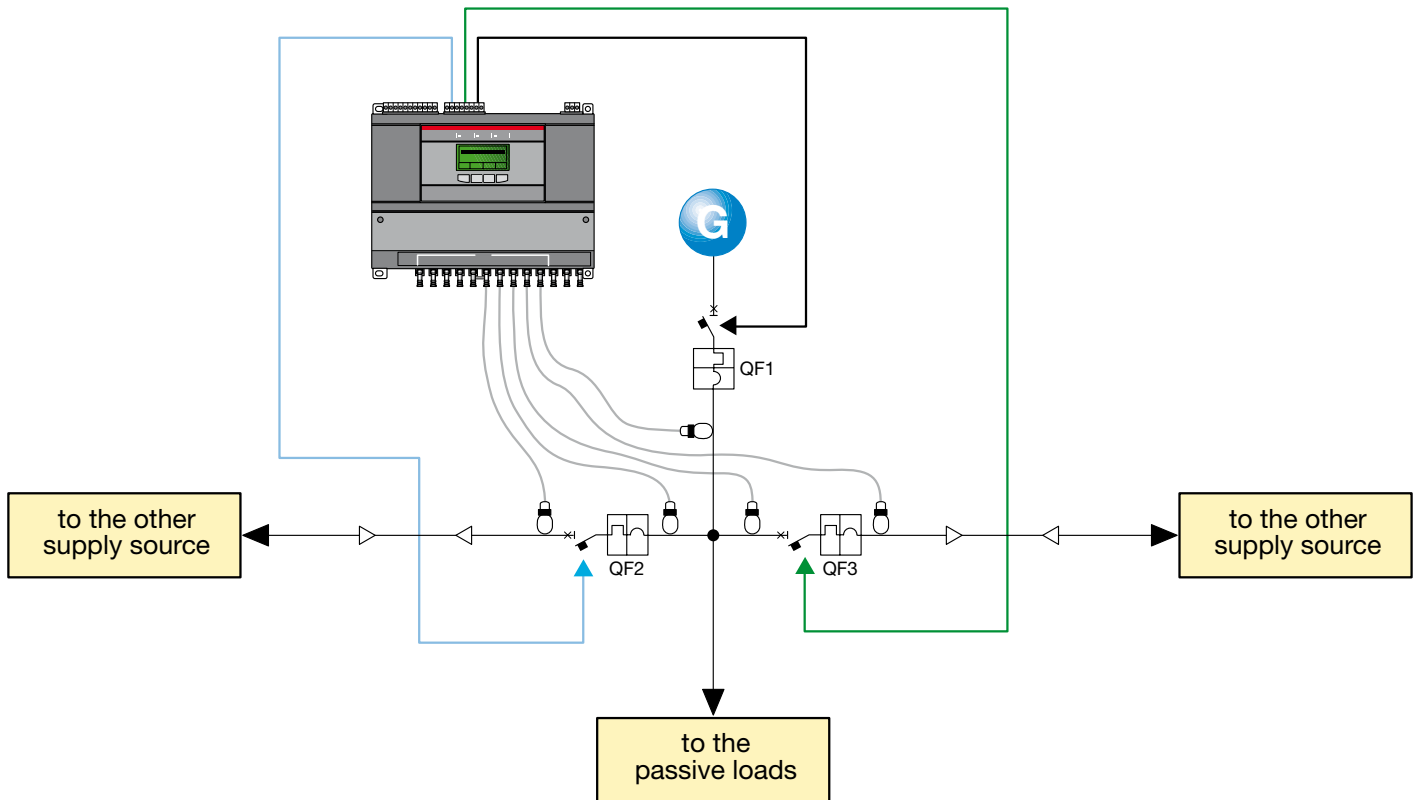

From an operational point of view:

To set this function on the TVOC-2 it is necessary to set correctly the dip switches positioned on the left side of the unit itself as shown in the following figure:

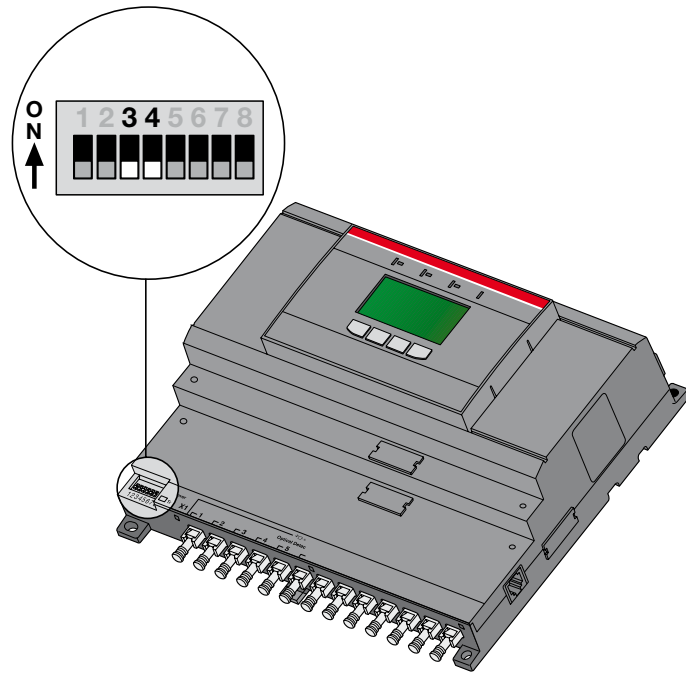

In this way, TVOC-2 will make the circuit-breakers QF1-QF2-QF3 trip simultaneously:

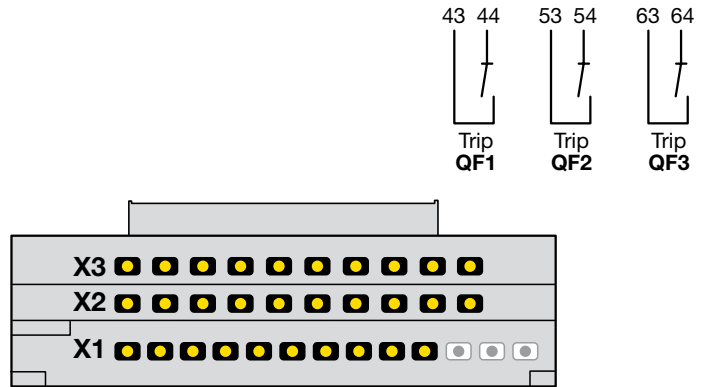

For each light signal detected by a light sensor belonging to any row (X1-X2-X3), TVOC-2 will command the trip of all the circuit-breakers QF1-QF2-QF3.

Refer to the example on page 15 for the wiring between the circuit-braker and the TVOC-2.

4. Application example

The following pages show an application example aimed at explaining and giving further information about the connections to be carried out between Emax circuit-breaker with PR122 LSI, equipped with the module PR120/K and TVOC 2.

In case of internal arcing, the bright sensors will command opening for all the circuit-breakers in the assembly.

The following Figure shows, as a mere indication, the positioning of the circuit-breakers inside the switchgear.

As regards positioning of the bright sensors inside the assembly, it is necessary to follow the description reported at page 5.

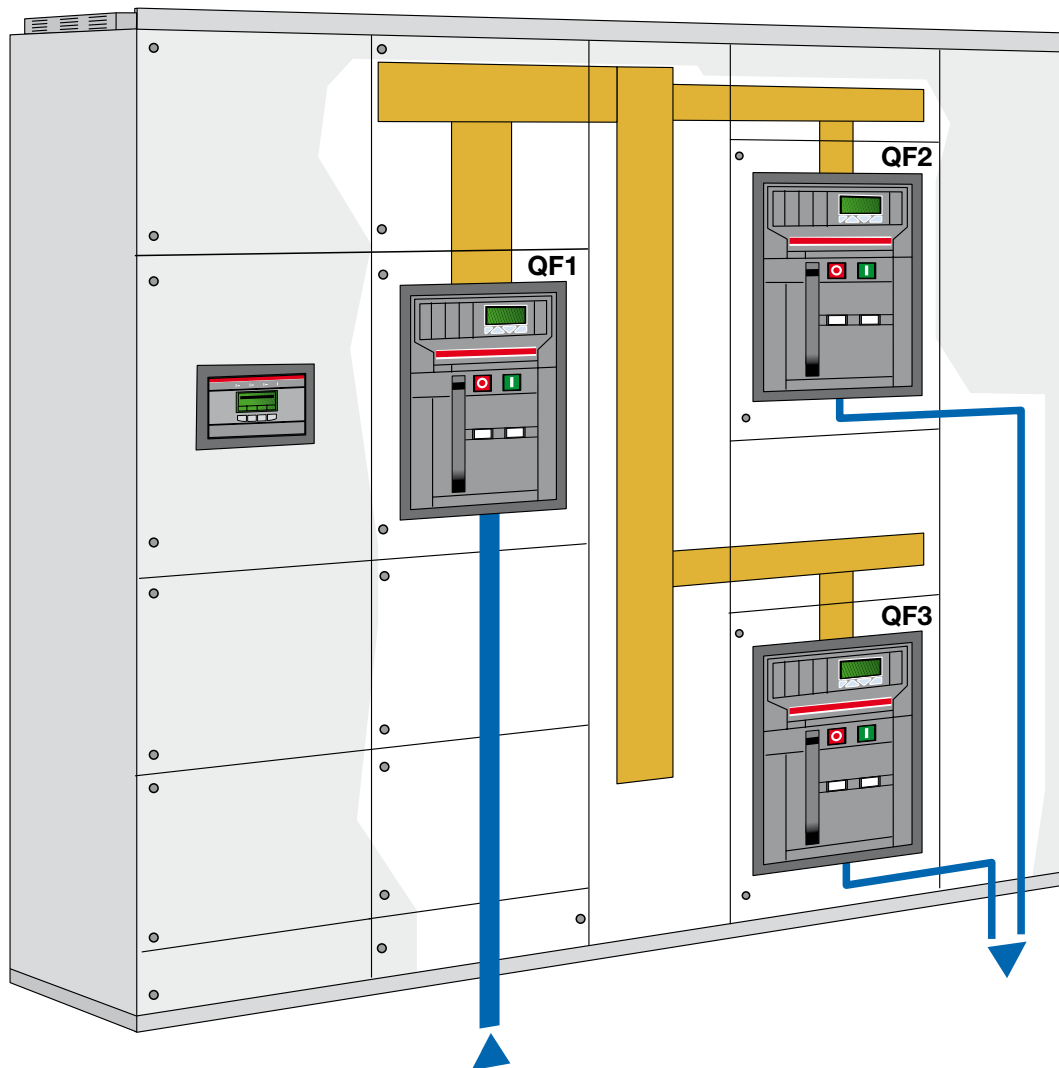

The following electrical diagram shows the connections to be made between TVOC-2 and the trip units of the circuit-

breakers (galvanically insulated 24Vdc power supply is needed for the trip units).

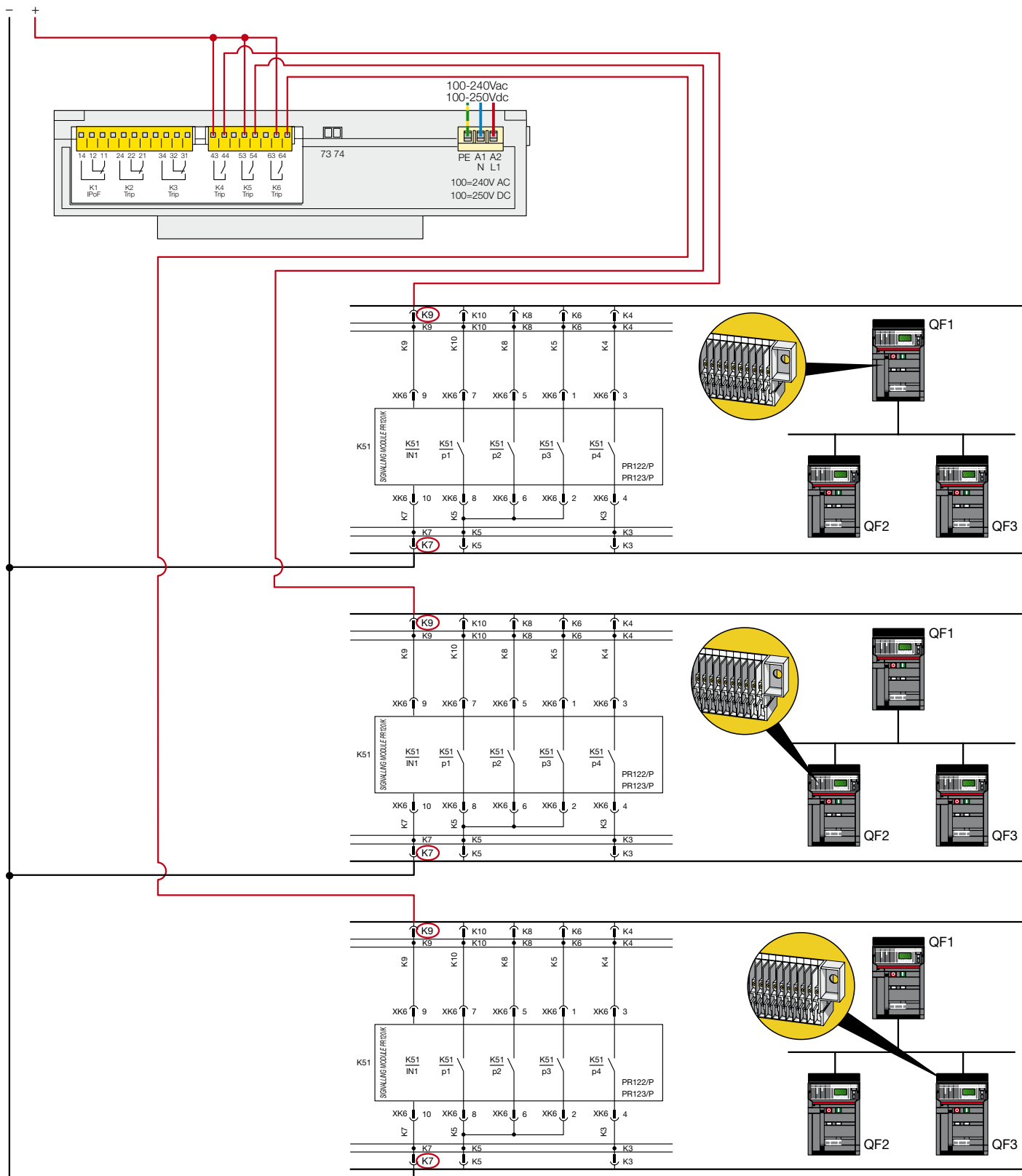

4. Application example

Configuration procedures:

TVOC-2

Since in case of detection by any light sensor the opening of all the circuit-breakers is required, it is necessary to set accordingly the dip switches at the bottom of the module on its left side.

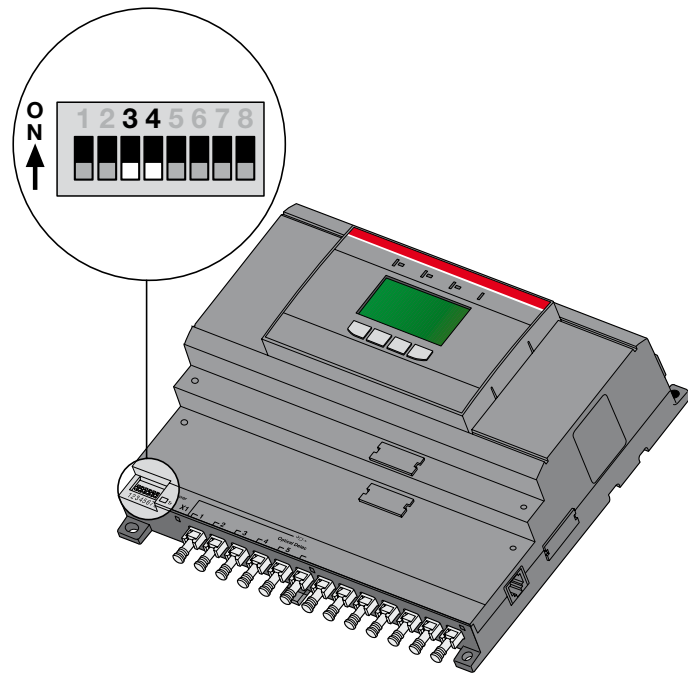

Having set the dip-switches 3 and 4 as shown in the figure, for every light flux detected by any sensor there will be the tripping of all the three circuit-breakers.

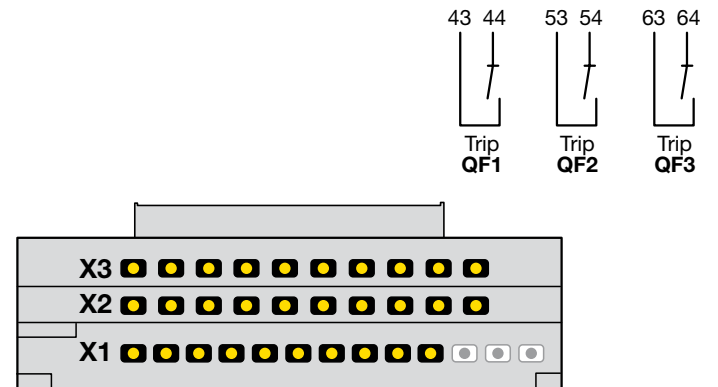

For each light signal detected by a light sensor belonging to any row (X1-X2-X3), TVOC-2 will command the opening of all the circuit-breakers QF1-QF2-QF3.

Emax PR122+PR120/K (solution valid also in case of PR123+PR120/K)

As mentioned in the previous pages, to reduce the total trip times it is possible to use the input digital contact of the signalling module PR120/K.

To customize properly this module, in addition to the possibil-

ity of configuring it directly from the menu of the trip unit, it is possible to use the accessories PR010/T, BT030, PR120/D-BT.

The following pages show the navigation path to follow from the display of PR122.

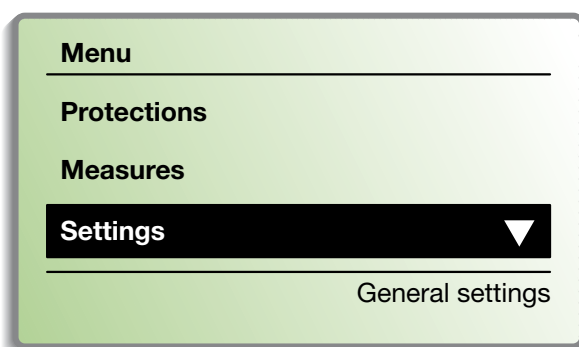

From the menu choose "settings"

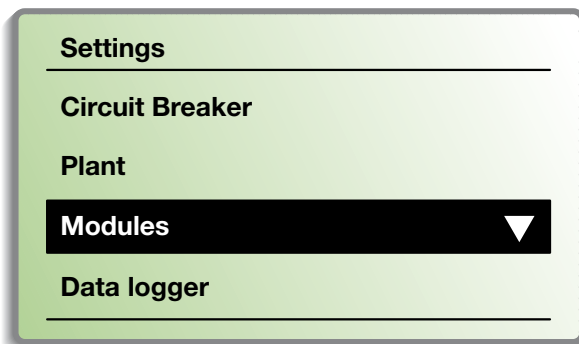

Select "modules"

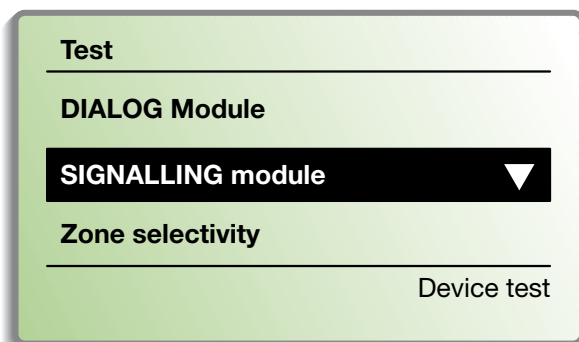

In this section it is possible to navigate and configure the different modules of the trip unit, in this case select "signalling module"

4. Application example



SIGNALLING module

Relay n.1 ▼

Relay n.1

Relay n.1

Relay settings

In the section relevant to the module **SIGNALLING**, it is possible to configure 4 output contacts which allow the remote signalling of alarms and trips of the circuit-breaker and 1 input contact. Since in our case we have to configure the input contact, scroll to the bottom.



SIGNALLING module

Relay n.1

Relay n.1

Input ▼

Input

Select "input"

At this point it is necessary to configure correctly the three parameters of this digital contact so that for each 24Vdc input signal, the trip unit will command the circuit-breaker opening.

Input

Polarity

Function

Delay

Active high

Select "polarity"

Password

0***

Password settings

Enter password

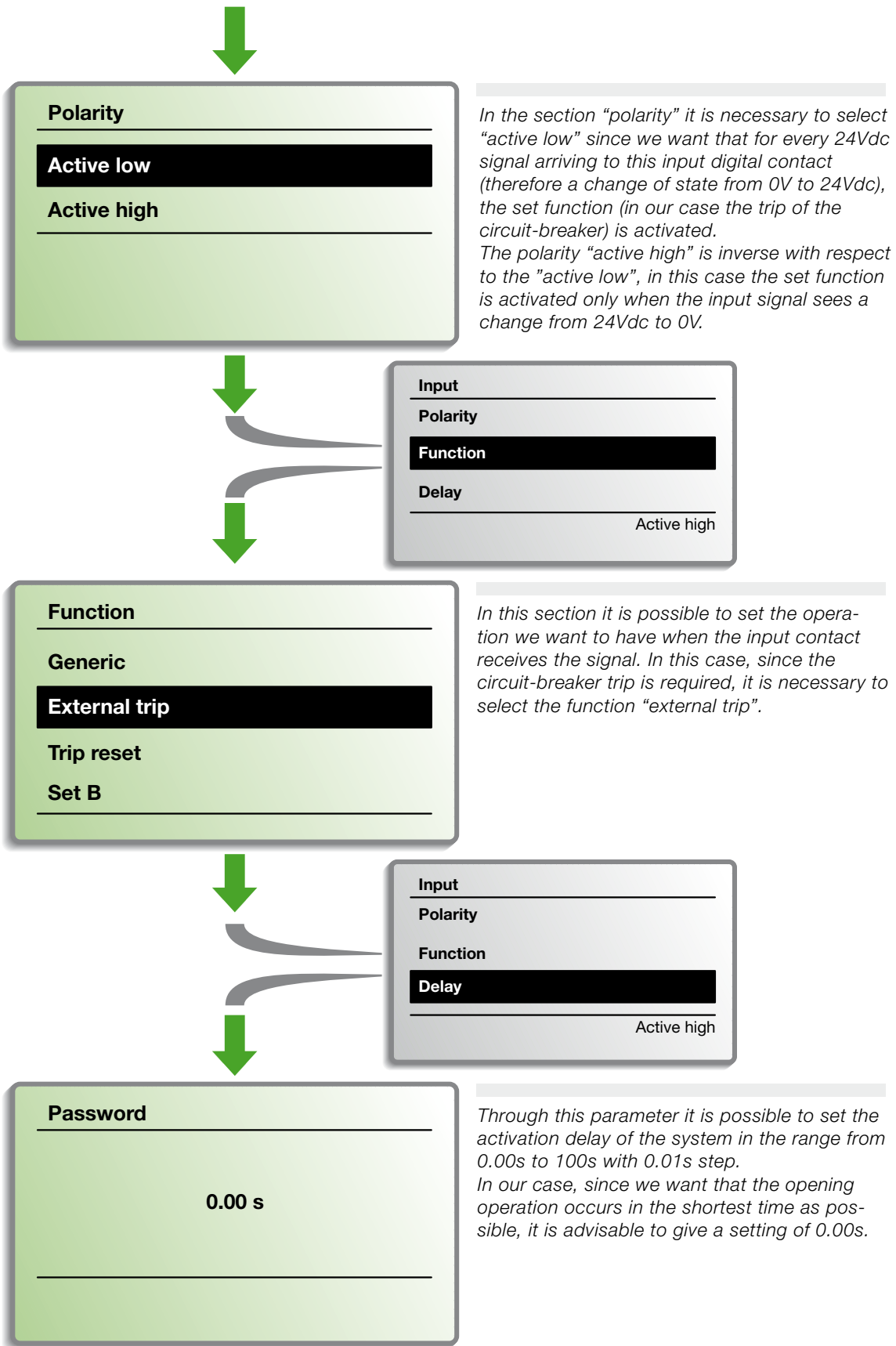

Contact us

ABB SACE

A division of ABB S.p.A.

L.V. Breakers

Via Baioni, 35

24123 Bergamo - Italy

Tel.: +39 035 395 111

Fax: +39 035 395306-433

www.abb.com

ABB AB

Cewe-Control

SE-721 61 VÄSTERÅS, Sweden

Telephone +46 21 32 07 00

Telefax +46 21 12 60 01

www.abb.com/lowvoltage

The data and illustrations are not binding. We reserve the right to modify the contents of this document on the basis of technical development of the products, without prior notice.

Copyright 2011 ABB. All rights reserved.

1SDC007407G0201 - 02/2011