

SURGE PROTECTIVE DEVICES

Select® - SL3™ series | 80 kA

Current Technology®



Select® SL3™ suppression filter systems feature selenium-enhanced surge protection along with a powerful failure-free ISM™ (Integrated Suppression Module). The ISM™ contains individual thermally fused and protected MOVs, surge-rated copper busing, robust filtering and advanced remote communications capabilities. Additionally, the SL3's selenium-enhanced seamless technology design ensures maximum performance and a dramatically extended product life.

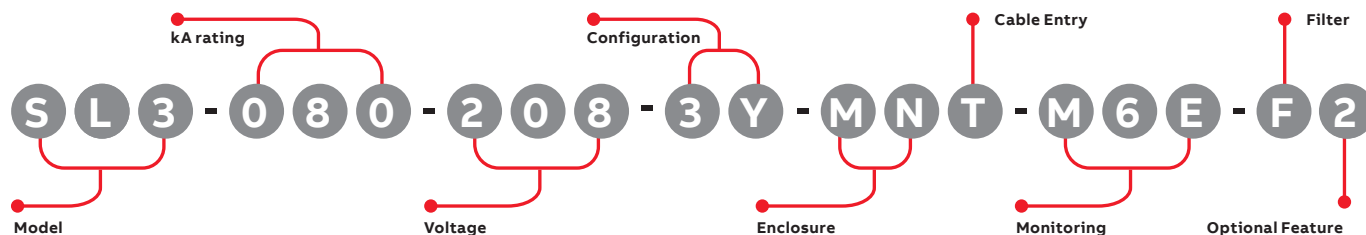

kA Rating	Voltage* (Consult factory for additional Voltages)		Configuration* (Consult factory for additional Configurations)		Enclosure	
050	208	120/208	1G	1 Phase, Grounded	MN	Metal Without Disconnect
080	240	120/240	2G	2 Phase, Grounded, Split Phase	SN	Stainless Steel Without Disconnect
100	380	220/380	3Y	3 Phase, Grounded Wye		
125	480	277/480	3H	3 Phase, Grounded, High Leg Delta		
150			3D	3 Phase, Grounded Delta		
200						
250						
300						

*See table on back for more Voltage/Configuration Options.

Cable Entry	Monitoring	Filter	Optional Features	Stand-Alone Options (To Be Ordered As Separate Items)
T Top Feed	M0 No local monitoring (see remote MxX stand-alone option)	F Filter	2 Test Port	DTS DTS-2 Diagnostic Test Set
B Bottom Feed	M1 Smart switching tri-color/LED/ Phase, Audible Alarm & Dry Relay Contacts	N No Filter		MxX Remote Monitor Extension M1X through M6EX
	M2 M1 + Surge Counter			HPI HPI Cable
	M3 Advanced Monitoring, Character Display, Modbus RTU			
	M4E M3 + Ethernet, Modbus TCP			
	M5 Advanced Monitoring, Graphics Display, Modbus RTU			
	M6E M5 + Ethernet, Modbus TCP			

Product Specifications

General Specifications

Maximum Surge Current Rating	80kA Per Mode, 160kA Per Phase
Nominal Discharge Surge Current	I-n = 20kA
Safety Listings	UL Listed 1449 5th Edition for Type 1 and Type 2 SPD applications, cUL, and UL 1283 / Meets Requirements for UL 96A / Compliant to IEEE C62.41.1-2002, C62.41.2-2002 and C62.45-2002 / NFPA 70 [NEC], Article 285
Protection Method	Thermally protected MOVs, Selenium, Capacitive Filter
Product Design	Individual thermally fused and protected MOVs, Selenium Cells, and All Copper, Tin-plated Bus
Dimensions	16"H x 16"W x 9.2"D
Weight	42 lbs.
Enclosure Type	NEMA 4/12 Standard (NEMA 4X Option)
Installation Location	Outdoor or Indoor
Operating Environment	-25°C to +60°C 5% – 95% Non-Condensing Humidity
Fault Current (SCCR)	200kAIC
Connection Method	Parallel
Protection Modes	All Modes (L-N, L-G, N-G, L-L)
Response Time	< 0.5 Nanoseconds
Operating Frequency	47 – 63 Hz
Warranty	20 Years

Filtering Attenuation Frequencies (Per Mil-Std-220B January 2000)**

10 KHz	100 KHz	1 MHz	10 MHz	Max at 142 KHz
18.1 dB	44 dB	22.8 dB	15.3 dB	54.6 dB

Single/Repetitive Surge Current Capacities (Tested)**

Protection Mode	Single Pulse Surge Current Capacity/ Mode	Repetitive Surge Current Capacity/ Mode
Line-to-Neutral	80,000A	12,000 Impulses
Line-to-Ground	80,000A	12,000 Impulses
Neutral-to-Ground	80,000A	12,000 Impulses
Line-to-Line	160,000A	24,000 Impulses
Per Phase	160,000A	24,000 Impulses

Maximum Continuous Operating Voltage (MCOV)

Voltage	L-N MCOV	Voltage	L-L MCOV
120V	150V	240V	300V
277V	320V	480V	552V
347V	420V	600V	690V

** Data based on actual tests. Contact factory for test reports

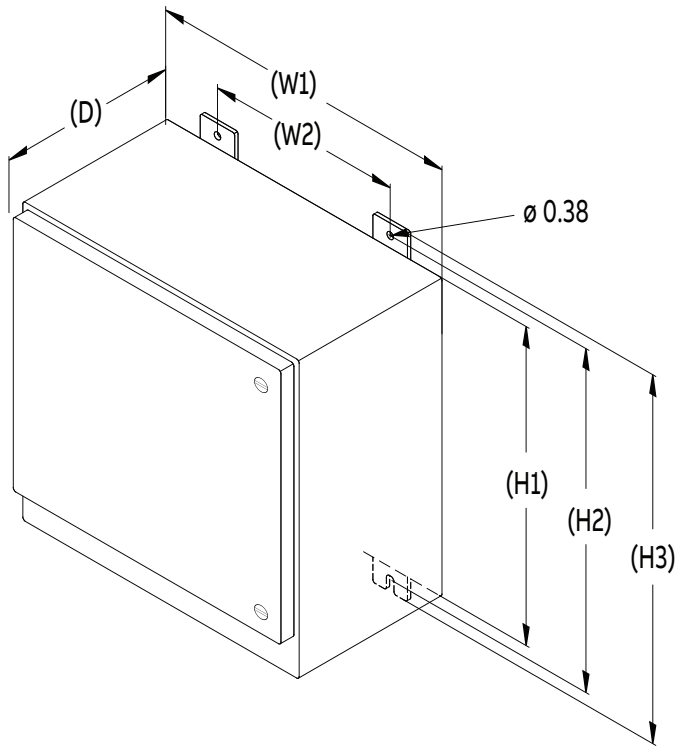

Dimensional specifications

SL3™/080	Inches	(mm)
H1	16.00	(406.4)
H2	17.25	(438.2)
H3	18.50	(469.9)
W1	16.00	(406.4)
W2	10.00	(254.0)
D	9.20	(233.7)

Voltage/configuration options

Not all voltage configurations are displayed, contact your local sales representative for additional configurations.

	1-Phase, Grounded	2-Phase, Grounded, Split-Phase	3-Phase, Grounded, Wye	3-Phase, Grounded, High-Leg Delta	3-Phase, Grounded, Delta
	1G	2G	3Y	3H	3D
120	X				
208	X		X		X
220	X	X			X
230	X				X
240	X	X		X	X
380		X	X		X
415		X	X		X
480		X	X		X

—
SL3™/80 performance data

System Voltage	120/240V or 120/208V				277/480V				347/600V				240V Delta		480V Delta		600V Delta	
Protection Mode	L-N	L-G	N-G	L-L	L-N	L-G	N-G	L-L	L-N	L-G	N-G	L-L	L-G	L-L	L-G	L-L	L-G	L-L
MCOV	150	150	150	300	320	320	320	552	420	420	420	690	320	300	552	552	690	690
B3 Ring Wave 6kV, 500A	580	700	740	590	560	620	730	660	570	650	730	680	620	590	1530	660	-	-
B3/C1 Combo Wave 6kV, 3kA	596	675	682	964	1020	1066	969	1824	1197	1260	1186	2354	1066	964	1604	1824	1260	2354
C3 Combo Wave 20kV, 10kA	1640	1460	1520	1960	1890	1890	2020	3020	2080	2200	2140	3390	1890	1960	2460	3020	-	-
UL 1449 5th Edition VPR 6kV, 3kA	700	700	700	1000	1200	1200	1000	2000	1200	1500	1200	2500	1200	1500	1800	2000	3000	2500

All SL3™ systems voltage protection ratings (VPR) are peak values (±10%) measured from the 90° reference point and are in compliance with test and evaluation procedures outlined in ANSI/IEEE C62.41

