

review

02|2019 en

Digital twins and simulations

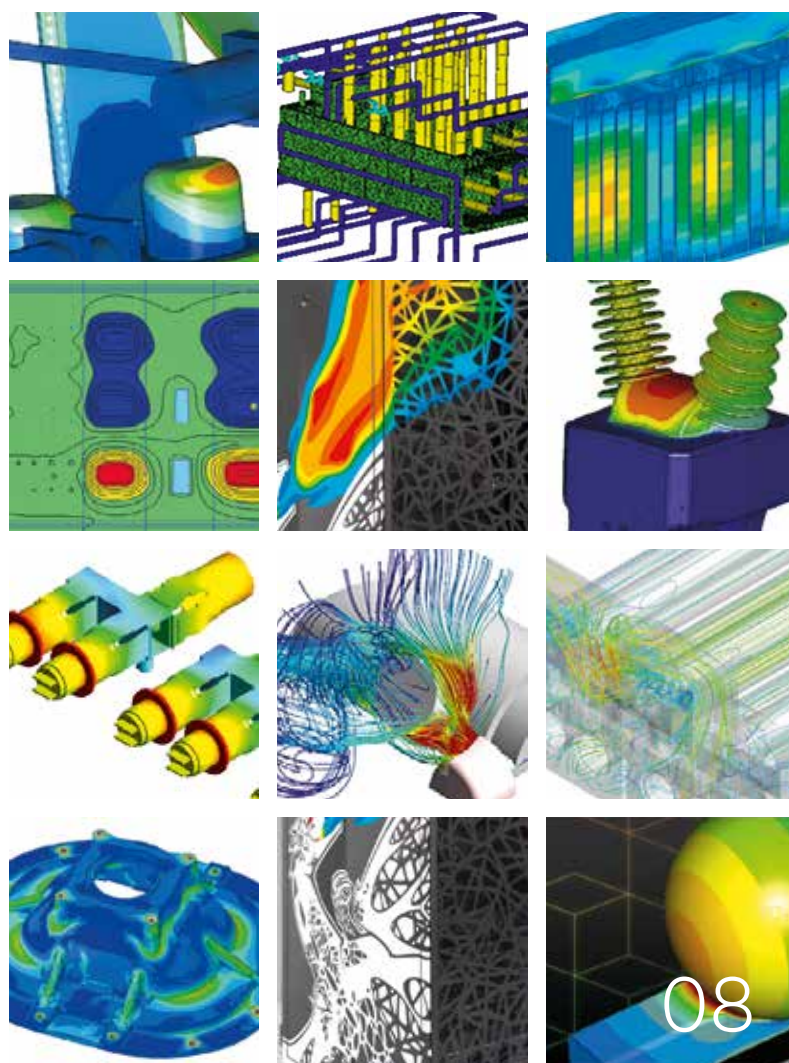

42

—
06 – 69 Digital twins and simulations
70 – 77 Productivity

08

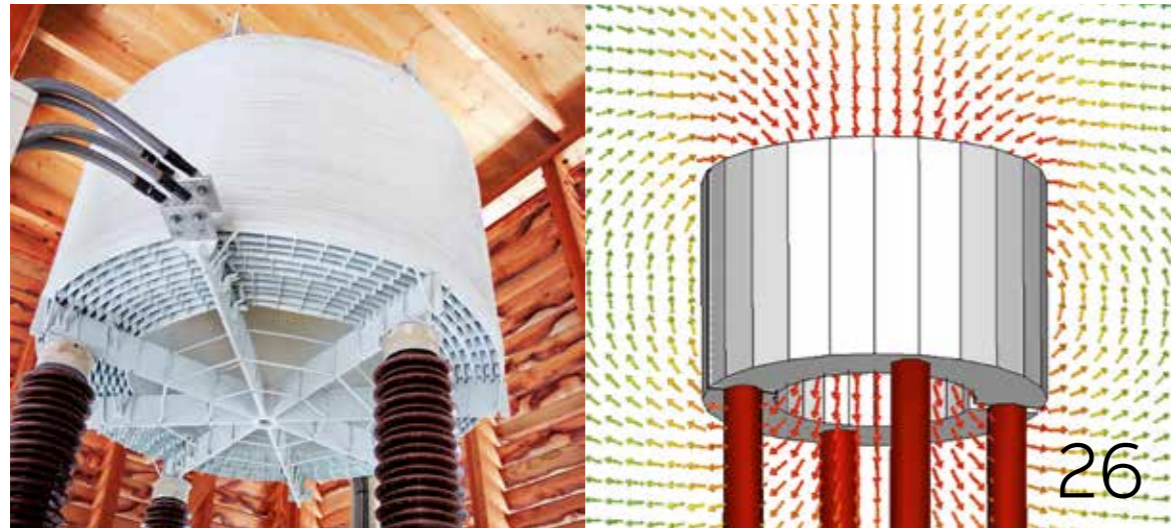

HVDC Light® digital twins



Process module engineering



Mitigating internal arc impact

Connected analytics



05 Editorial

Digital twins and simulations

- 08 World of simulation
- 14 Edge-Cloud synergy with digital twins
- 20 Electrothermal simulations
- 26 HVDC Light® digital twin
- 34 Connected analytics
- 42 Easy simulations for engineers
- 47 Advanced simulations
- 52 Digital avatars for powertrains
- 58 Monitoring of rotating machines
- 64 Mitigating internal arc impact

Productivity

- 72 Process module engineering

Buzzword demystifier

- 78 Cloud, edge and fog computing

79 Imprint

—
Imagine your digital twin living in a virtual world in which you could test every decision, anticipate any surprise, and thus build your best and most successful life. ABB uses such modeling to design, operate, and maintain mission critical equipment and support services. This issue of ABB Review explores how these alternate world simulations yield real world results.

EDITORIAL

Simulations and digital twins



Dear Reader,

Discussions on digitization often focus on advantages delivered while a system is up and running. But digitization and artificial intelligence can be applied long before equipment becomes operational: in specification, design, manufacture and configuration.

Simulation shortens analysis and design cycles and assures better optimized results by allowing a greater number of variants to be investigated. Artificial intelligence supports the creation of simulation models and the identification of trends. The results of simulations are no longer stranded in closed environments but can easily be shared for other uses throughout the device's lifecycle. A digital twin facilitates this by digitally mirroring vital data and behavior. In doing so, it simplifies activities ranging from configuration to condition monitoring and prediction. If desired, this data can even be accessed on handheld devices, for example aided by augmented reality, to support decisions on the factory floor.

I trust this issue of ABB Review will provide fresh insights into the rapidly evolving world of simulations.

Enjoy your reading,

A handwritten signature in red ink, appearing to read 'Bazmi Husain'.

Bazmi Husain
Chief Technology Officer

Digital twins and simulations

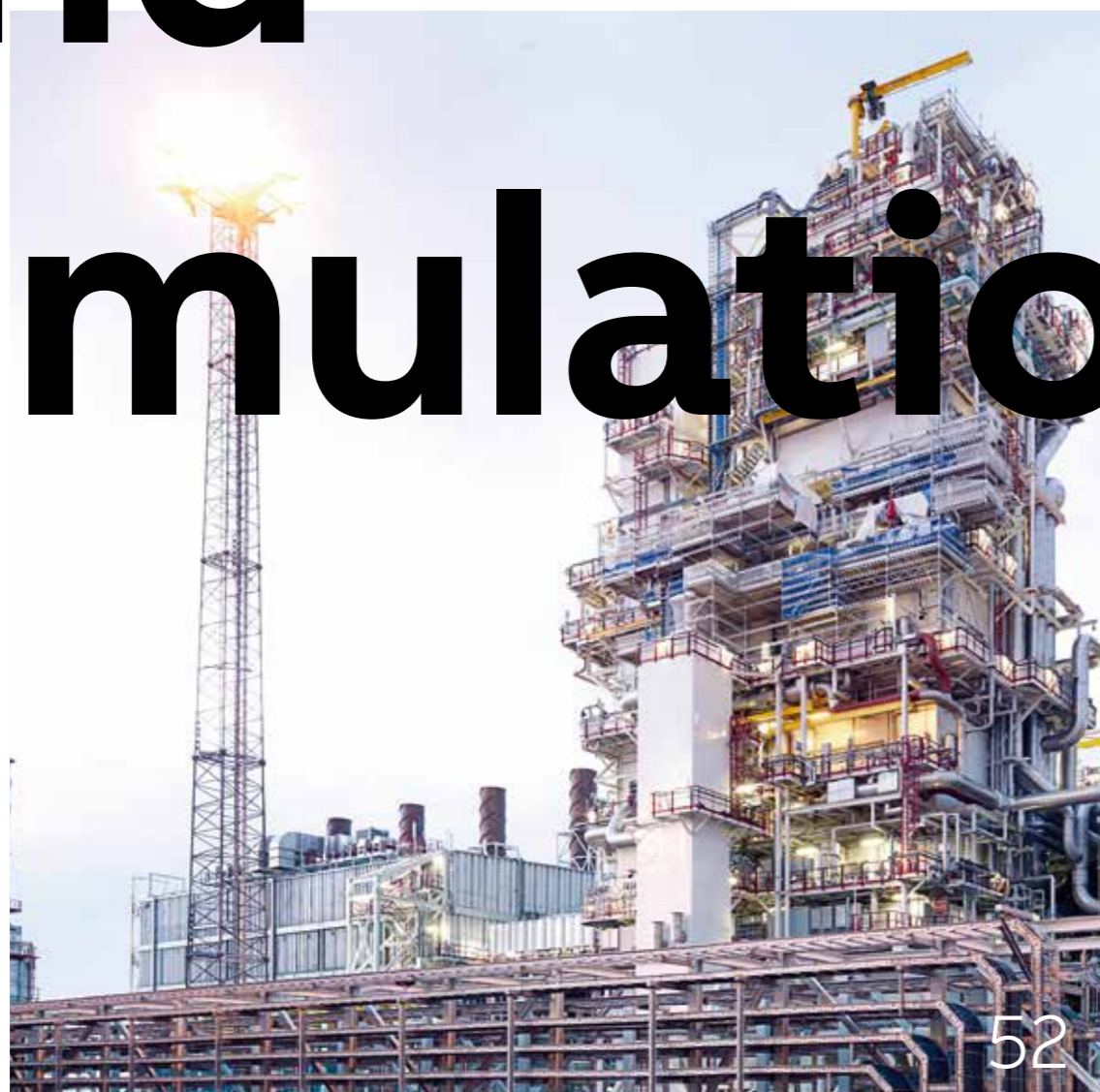

What can be accomplished in an all but infinitely variable virtual testing environment? Advanced product design, iterative improvements based on use, performance management, and simulations of outlier events, just to mention a few outcomes. AI can use simulation algorithms and capture the power of the digital twin – at the edge, in real time, to learn faster and better, and thereby find more and better solutions.

- 08 World of simulation
- 14 Real-time AI powered by edge-deployed digital twins
- 20 Electrothermal simulations improve equipment thermal design
- 26 HVDC Light® digital twin facilitates EMC design
- 34 Managing solar asset performance with connected analytics
- 42 Making simulations easy for engineers
- 47 Advancing product design and manufacturing with 3D printing
- 52 Digital avatars for powertrains expand digital twin concept
- 58 Transforming condition monitoring of rotating machines
- 64 Mitigating internal arc impact

DIGITAL TWINS AND SIMULATIONS

World of simulation

Simulations and digital twins are revolutionizing the way we think about the development and deployment of products.

—
Marek Florkowski
Daniel Szary
 ABB Corporate Research
 Krakow, Poland

marek.florkowski@
 pl.abb.com
 daniel.szary@pl.abb.com

—
Andreas Moglestue
 ABB Review
 Baden-Daettwil,
 Switzerland

andreas.moglestue@
 ch.abb.com

The phrase “all is number,” attributed to Pythagoras, is more pertinent now than ever before. Numbers enable us to capture and process physical magnitudes, be they positions, temperatures, flow rates, field strengths and many other quantities. A vast inventory of ingenious methods exists for measuring, or in other words, describing the physical world using numbers. The age of computing has added a new and highly versatile tool: simulation.

Simulation permits the inference of data that is not directly available for measurement. It is possible, for example, to gauge the temperature deep inside an object from measurements of the surface temperature, combined with physical understanding of what is happening inside the object. The inaccessibility of a measurement point must not be strictly spatial. The data of interest can also be in the future, or even in a system that has not physically been built.

—
Product developers have more scope to be innovative, can test a far greater number and combination of variants, and can experiment with unorthodox approaches.

Compared to physical testing, simulation can deliver huge savings in time and costs, as well as avoiding waste and potentially dangerous situations. Physical laboratory testing incurs a considerable time latency due to the need to prepare and build test samples and setups, constraints imposed by the capability and capacity of the lab, not to mention inflexibility should

developers request a last second modification. In a design process requiring numerous design iterations, with each iteration having to await the results of the previous test, such a time penalty can be immense.

Time and cost advantages apart, simulations also permit a far broader range of variants to be studied. Product developers have more scope to be innovative, can test a far greater number and combination of variants, and can experiment with unorthodox approaches. The result is a more optimized solution.

In some cases, simulations are the only viable way to verify a design because physical tests are not realistically feasible, for example large scale seismic tests.

Today, almost all aspects of a product’s lifecycle can be simulated: manufacturing, virtual testing, transportation, regular operation, aging, harsh environmental conditions, extreme situations (earthquakes, arcs, thunder strikes, overloads, etc.).

Simulations in ABB

ABB makes broad use of simulation in product development. Simulations cover a wide range of fields, including, electromagnetics, thermodynamics, mechanics, fluid dynamics and material science. Increasingly, simulations also combine several of these domains and capture not only the sum of their effects but also the coupling and interactions between them in what are called multi-physical simulations.

In 2013, ABB Review dedicated an issue to simulations →1. A look back on that publication today reveals just how far the field has advanced since then. Capabilities that at the time were considered wishful and futuristic are now tested

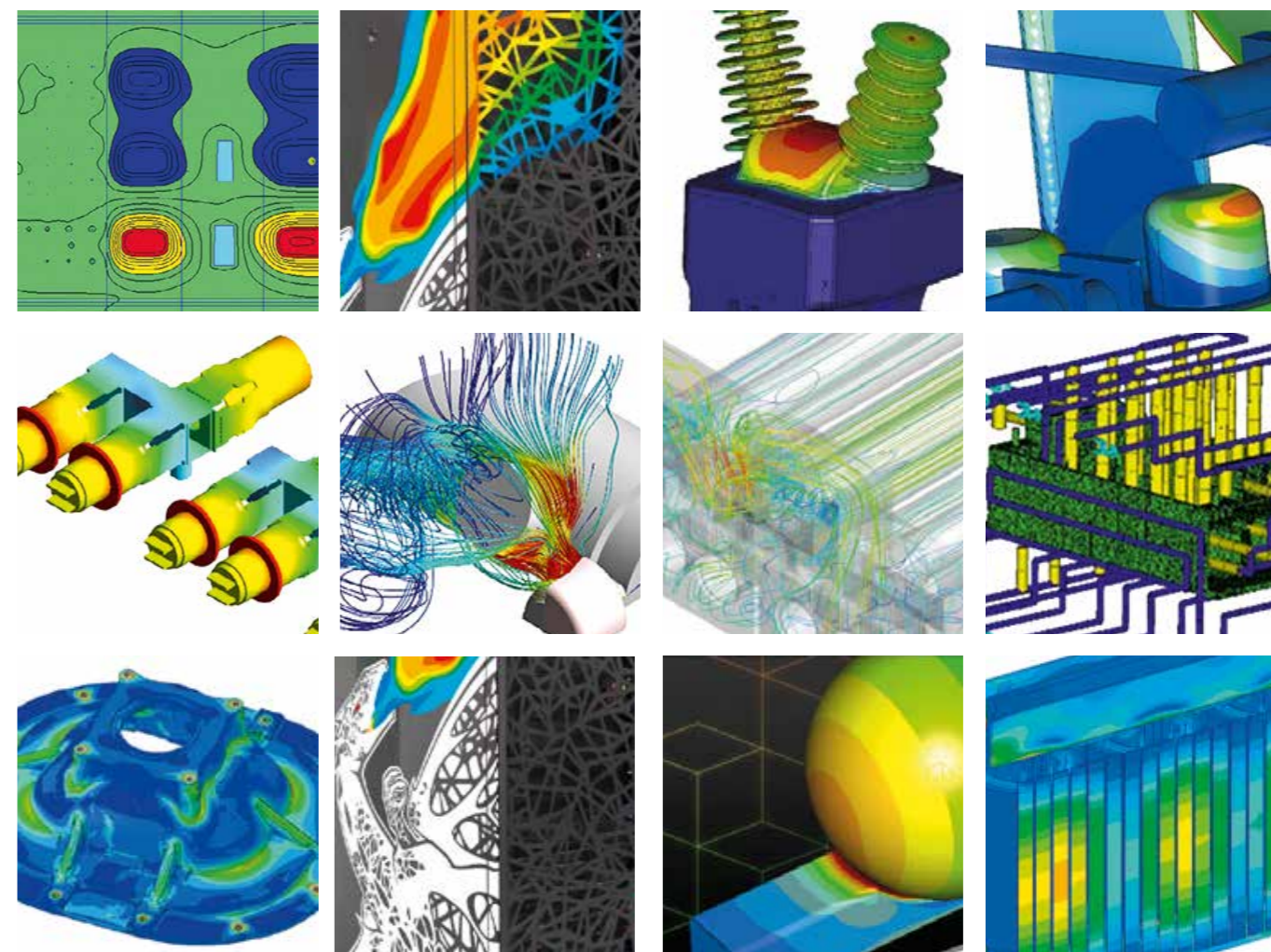

and proven components of the simulation toolbox. The present issue of ABB Review brings the picture up to date and looks towards future developments.

Progress in simulations

Major drivers in advancing the capability of simulations have been growth in computing power and speed as well as affordability, but also ease of use. What would have been a major, processor-hungry job 25 or 30 years ago can now easily be completed in less than half an hour (plus preparation of the model). Besides the overall increase in speed, today’s simulations can take a larger number of variables into account, adding to the overall accuracy of the simulation.

Further to the hardware and cost aspects, there have been considerable changes in the roles of simulation engineers. In the early days, experienced engineers would typically have invested a lot of time in creating models and setting up simulations. Such is the advancement of knowledge and

—
Major drivers in advancing the capability of simulations have been growth in computing power and speed as well as affordability, but also ease of use.

computer literacy, but also improvements in automation and the tools themselves, that today many such tasks can easily be performed by junior staff or students. Far from implying a de-skilling, this shift means simulations experts can now concentrate on the interpretation of results and on guiding and advising design decisions →2.

Year by year, simulations are becoming simpler to use. This “democratization” is enabling the adoption of simulation in more and more areas.

Feedback from the physical world

The most sophisticated simulation is of no value if the results do not adequately reflect what happens in the physical world. Confidence in simulations is improved by comparing simulation results with physical tests as well as field experience. It is the hallmark of a good simulation method that results do indeed prove a good match to laboratory tests →3.

—
It is the hallmark of a good simulation method that results do indeed prove a good match to laboratory tests.

Multiphysical simulations

A simulation must digitally mirror phenomena occurring within a physical object or system. As in the real world, multiple physical effects act on an object simultaneously. For example - looking at an installation purely from the electrical point of view – it is relatively straightforward to determine an optimal cable cross-section. But taking into account other phenomena, such as thermal effects or mechanical vibrations, this optimum may need to be reconsidered. Simulations must thus reflect

effects in different physical domains (electrical, mechanical, thermal).

Often, the interdependence of these effects needs to be considered. For example, simulation of an arc requires simulation of the dynamics of the plasma, as well as of its electromagnetic behavior and heat generation and cooling. These phenomena are all mutually linked as, for example, the local conductivity of the plasma influences the heat generated, and the resulting temperature feeds back into conductivity. The heat also affects the spatial movement and redistribution of the plasma which in turn affects changes in local conductivity, and so on. The chain of influence is thus highly meshed and the respective calculations of the individual domains must run concurrently and exchange information.

—
01 ABB Review 3/2013, dedicated to simulations, was a landmark publication that generated a lot of positive feedback.

—
02 Interpretation of results is an important part of simulation.

—
Footnote
1) See also "Digital twin – virtually identical?" in ABB Review 2/2018, pages 94–95.

Before simulations were available, design decisions of this type were often based on experience, backed up by observation. Simulations enable a far more detailed understanding of what occurs within a phenomenon such as an arc than was previously possible.

Digital twins

A simulation requires, as a starting point, basic data about a device or system. With different simulations being performed on the same product, computational efficiency can be gained by relevant data being shared between simulations rather than totally separate and incompatible inputs being generated manually in every case. This data can also be used for myriad other purposes in different phases of the product's lifecycle, including system integration, diagnostics, prediction and advanced

—
Simulations enable a far more detailed understanding of what occurs within a phenomenon such as an arc than was previously possible.

services. A virtual image of the physical device or system is created that simplifies the accessibility of data and verification of properties. This structured collection of data and algorithms forms the device's digital twin.¹



01



02

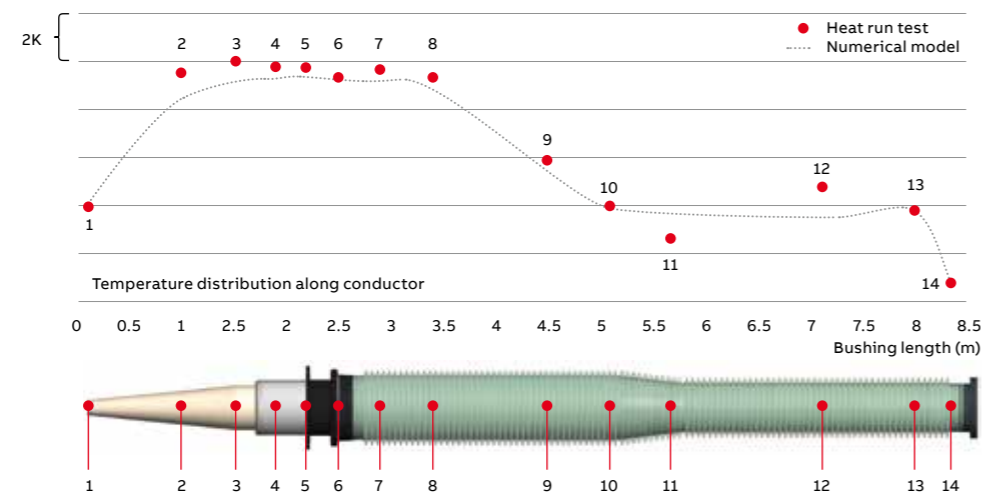

03

A digital twin can provide a unified repository serving all relevant data associated with a device. This can range from CAD information and documentation to lifetime and service history, operating hours and a wealth of other pertinent information. It can also embed simulation algorithms that can, for example, advise a system configurator or operator whether a planned operation will overload a device or take it outside a specified envelope. Allowing, for example, a temperature to rise above a critical value may shorten the device's service interval or lifetime, but an informed operator or plant manager may choose to do so nevertheless for operational reasons. Such data can be provided with a one-click query. The usability of such a tool can be improved with augmented reality (a technician looks at objects through the camera of his or her mobile phone and the pictures are automatically annotated or overlaid with interactive information).

In addition to being available on workstations and hand-held devices, querying tools of this type can be embedded directly into the next generation of control-system interfaces so as to be constantly available without requiring any manual transfer of data.

Besides individual devices, larger processes and systems (such as for example a group of collaborating machines in a factory) can also have digital twins comprised of the individual digital twins of the components plus data on their configuration and interaction. Digital twins can also capture the interfaces between devices

and thus support system configuration, testing and troubleshooting.

Tools and methods of simulation

In its simulations, ABB uses a mix of commercial, open-source and self-developed tools. The choice depends on the precise problem, and part of the skill in simulation lies in knowing how to select the best tool.

The model for simulation is prepared based on information from the design (such as CAD data). Factors such as boundary conditions, loads etc. are taken into account.

—
A digital twin can provide a unified repository serving all relevant data associated with a device.

The process of preparing this data is already supported by a certain degree of automation. Such tools becoming easier to use has led to a “democratization” of simulation.

The computing power required depends on the simulation type. For example, in the electro-thermal analysis of complete medium voltage switchgear (approximately 50 million of cells in a finite volume mesh) a high-performance computer might be needed →4 (the simulation referred to runs for

—
03 Comparison of simulated and measured temperatures on conductor.

—
04 High-performance computers are required for processor-hungry simulations.

24 hours on 160 cores). In case of simpler models or different applications, a good laptop is sufficient. For example, a calculation of electric field emissions around a power station (90m x 150m) with a mesh size (in the areas of greatest interest) of around 2 cm was completed on laptop in two hours. For network calculations, a single run can take a few seconds only while returning a result of reasonable quality.

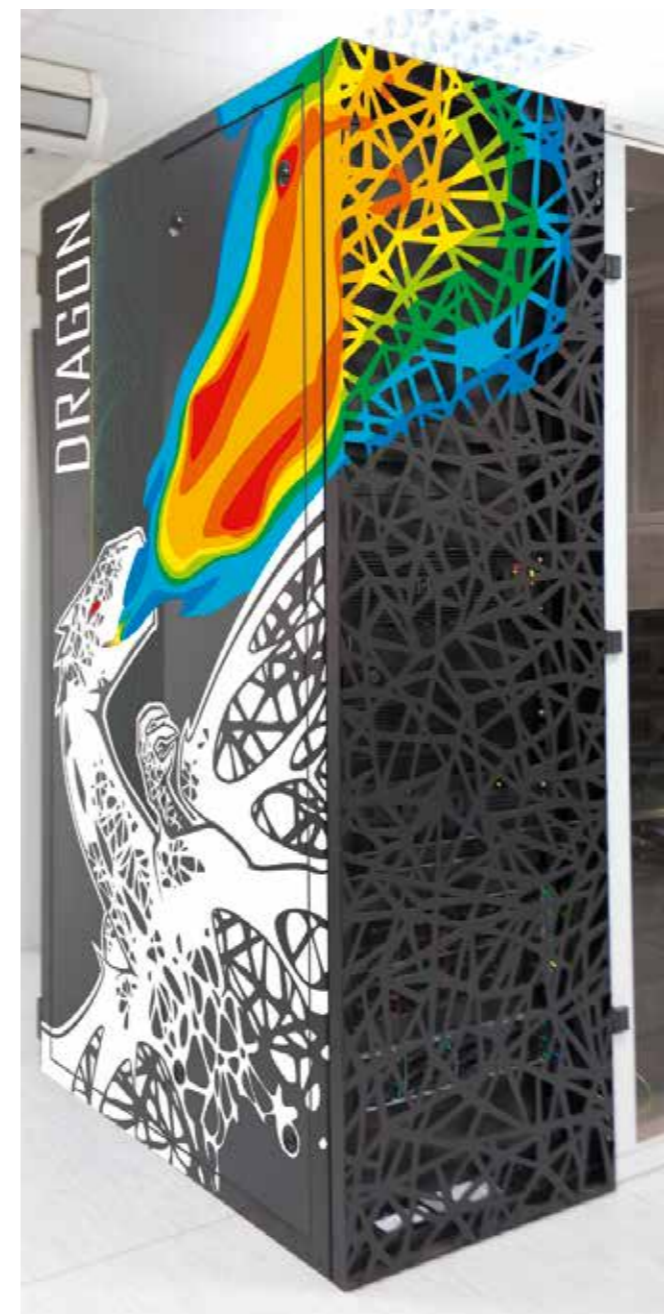

04

—
Simulation is about much more than replacing laboratory tests or speeding up product development.

Artificial intelligence (AI) is playing an increasing role in simulations, for example in creating the models and in recognizing and interpreting phenomena. One great strength of AI lies in the optimization of data correlation. AI can, for example, recognize which parameters have the greatest effect on optimization and suggest design variants that come closer to a design optimum.

Simulations and 3D/4D printing

The simulations described so far are typically performed well ahead of or independently of manufacturing or application, and are thus not considered real-time operations. An example where simulations may have to run in real-time occurs in 3D and 4D printing (a 4D object is a 3D object that embeds additional functionality). A simulation running concurrently to printing can be used to correct parameters during printing. For example, temporary temperature gradients caused by the printing process can be compensated.

Finding the optimum

Simulation is about much more than replacing laboratory tests or speeding up product development. Because it is so much easier to run a simulation than set up a test, it is possible to run a far larger number of simulations and thus explore a broader range of variants, including out-of-the-box thinking and “what if” ideas. By not artificially limiting simulation users to a given solution from the beginning, simulation is opening new avenues, not only in product design, but in manufacturing processes, business decisions, testing and verification, as well as service. Staff can play with different geometries and ideas and refine parameters in multiple iterations. Simulation removes barriers to creativity.

This issue of ABB Review presents selected examples of simulation from across the ABB Group. •

DIGITAL TWINS AND SIMULATIONS

Real-time AI powered by edge-deployed digital twins

Cloud-based digital twins deliver significant advantages. However, deploying the cloud-trained digital twin at the edge opens up new opportunities for autonomous systems, such as novel real-time artificial intelligence (AI) applications based on self-learning.



— Title picture. An edge-deployed digital twin can continuously evolve via self-learning while also ensuring that its cloud counterpart is kept synchronized and up-to-date. Moving the digital twin to the edge delivers a completely new set of advantages and opportunities for industries and utilities. Shown is a clean power plant, just one environment that can benefit from this technology.

— 01 The digital twin travels to the edge to meet its physical twin. The digital twin is executed and evolved on the edge gateway or on-device using self-learning approaches.

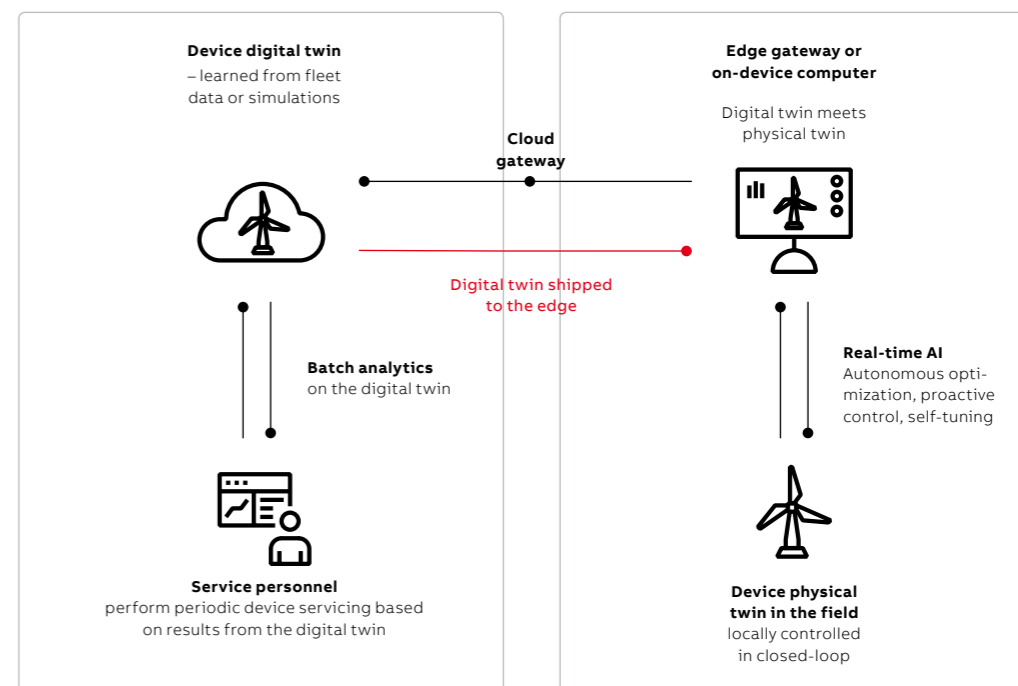

01



Mithun P. Acharya
ABB Corporate Research
Raleigh, NC, United States

mithun.acharya@
us.abb.com

Mirrasoul J. Mousavi
Former ABB employee

A digital twin is a digital representation of a physical asset (physical twin) that can be used for various purposes such as simulating the behavior of the physical asset. For example, a performance model of a solar inverter is a digital twin that characterizes the performance of the inverter.

— **Moving the digital twin to the edge will enable novel real-time AI applications.**

Depending upon the specific use case, there may be more than one digital twin for the said asset, process or system. This composability of the digital/physical twins gives great flexibility to define, evolve, compose and leverage twins for real-time IoT (Internet of Things) applications such as edge computing and analytics. Here, the term “edge” refers to software or hardware installed on the customer premises such as edge gateways, historians and plant devices and controllers.

Edge-deployed digital twin

The digital twin usually resides in, and is maintained in, the cloud and is fed with data from field devices or simulations. Digital twins are used to understand past and present operations and make predictions

by leveraging machine-learning approaches to condition monitoring, anomaly detection and failure forecasting. One example application of a digital twin is the (predictive) maintenance of the physical asset it represents.

What new applications are possible if one allows the cloud-learned digital twin to travel to the edge and meet its physical twin?

While edge devices in the past were used primarily for data acquisition and basic calculations, edge computing delivers advanced computations and cloud-assisted analytics that enable faster and localized decision making at the edge →1. Moving the digital twin to the edge will enable novel real-time AI applications due to the following:

- Lower analytics latency. In some cases, round-trip latencies to the cloud are not acceptable. With the digital twin executing at the edge, applications that require sub-second latencies are possible – for example, device protection functions, including shutoff, can be instantly invoked if a hazard is detected or forecast by the digital twin analytics.
- Closed-loop integration of analytics and local control. Analytics produced by the digital twin can guide the local control and vice versa. This leads to proactive control applications resulting in autonomous operation.

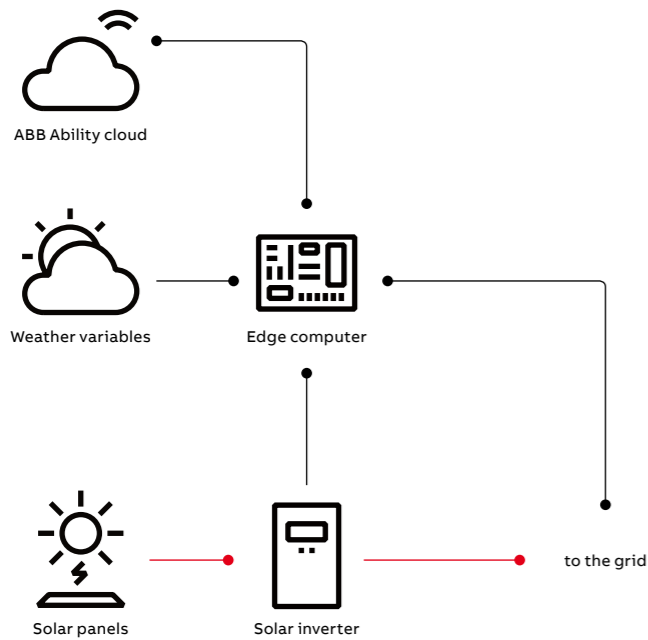

02

demand resulting from intermittent renewables and elastic loads. To operationalize smart inverter capabilities in a solar power site, the site's output power needs to be curtailed (by about 10 percent) so that there is headroom for these types of on-demand regulation.

The key to maintaining a desired regulation range and curtailment performance is the available peak power (APP) estimation. This quantity needs to be estimated and communicated within each control update cycle (typically under 4 s). The APP estimation algorithm considers solar irradiation, photovoltaic (PV) module current and voltage characteristics, panel temperatures, inverter efficiencies and other variables. The accuracy of the APP estimation is crucial for the regulation accuracy of the PV site, especially concerning up-regulation.

Machine learning and physics-based models are built in the cloud to model the APP, using historical data across the inverter fleet. A digital twin can then be derived from these models and transferred to ABB solar inverters to run edge analytics, on demand and in real time, in synergy with the cloud.

For example, a forecasted critical anomaly could be mitigated without human intervention.

- Faster evolution of the digital twin. Using approaches like online machine learning on streaming data and real-time reinforcement learning, the digital twin can continuously self-learn and evolve. This results in optimized system operation and self-tuning devices.
- For example, learning from and evolving its digital twin at the edge, a grid-connected energy device can infer optimal operational or control parameters for maximized output without impacting grid stability.

Executing the digital twin at the edge instead of in the cloud also has business advantages:

- Reduced cloud hosting costs. Sending all data to the cloud for storage and analysis can be costly.
- Data preprocessing reduces the data volume transmitted to the cloud.
- Sensitive data need not be sent to the cloud.
- Increased resilience. Analytics can be performed even when the digital twin is disconnected.

Three use cases illustrate the possibilities opened up by edge-deployed digital twins.

Real-time solar performance tracking for a resilient grid

Smart solar inverters can provide ancillary services to the grid, including voltage and frequency regulation, power-factor correction and reactive-power control. These advanced capabilities can help smooth out fluctuations in supply and

To show how the edge-deployed digital twin can be used on streaming inverter data to estimate inverter output in real time, a proof-of-concept demonstrator was realized in a Python environment. This demonstrator used field data from a solar site and an edge computing device similar to a Raspberry Pi →2.

Executing the digital twin at the edge instead of in the cloud also has business advantages.

The subject was a single-phase, 2.5kW inverter installed in a school property in the United States. A streaming program runs the data frames into the estimator and plots the output results on a visualizer.

→3 shows a hypothetical example of setting up the inverter for grid services. In this case, the output of the inverter is regulated constantly at 10 percent below the APP to leave room for up-regulation. The expected power at any given time is treated as the APP for that time. This estimate is the reference value for the next dispatch or control interval. As the solar input changes, so too does the APP to maintain a healthy margin for local inverter control.

Real-time transformer physical security

In this use case, the physical security of a large power transformer is twinned in the cloud and leveraged at the edge to monitor the transformer

— 02 Edge computing for solar inverter performance modeling and tracking.

— 03 Regulating inverter output in grid service mode. The negative reserve value around t=96 is a data collection artifact.

physical security in real time. Enhancement of the physical security of substations and transformers addresses a critical vulnerability that can affect grid reliability. ABB has developed a layered approach to transformer resilience, which includes real-time impact detection and assessment.

With controlled experiments and by using three vibration sensors and one acoustic sensor on the transformer, machine learning models are first designed and trained in the cloud to classify a physical impact on a transformer as benign or catastrophic.

The insight gained from this experiment can inform “goodness-of-fit” decisions, matching analytics performance with application requirements.

The trained models, which represent the digital twin of the transformer physical security, are deployed on the transformer at the edge for reporting and acting upon sensor-registered physical impacts on the transformer in real time.

Streaming analytics refers to applying machine learning and other data processing techniques to data in motion. This contrasts with conventional data analytics practices in which data is stored first and analyzed later. Streaming analytics can provide an instant reaction to stimuli as well as reduce data volumes.

A key consideration in streaming analytics is the rate at which an edge processor ingests streaming data and applies a machine-learning model to deliver the intended outcome (class label or regression). This important performance characteristic was quantified here using the sensor data (at 52,000 samples per second). Streaming this data rate into a cloud engine is challenging and thus provides a good representative case to understand how fast is fast enough and where bottlenecks might hinder real-time performance →4. The insight gained from this experiment can inform “goodness-of-fit” decisions, matching analytics performance with application requirements.

Model development (K-means clustering and decision tree classifiers) was done in a Python environment. Model deployment was achieved in a Raspberry Pi as a proxy for a single-board computer edge device.

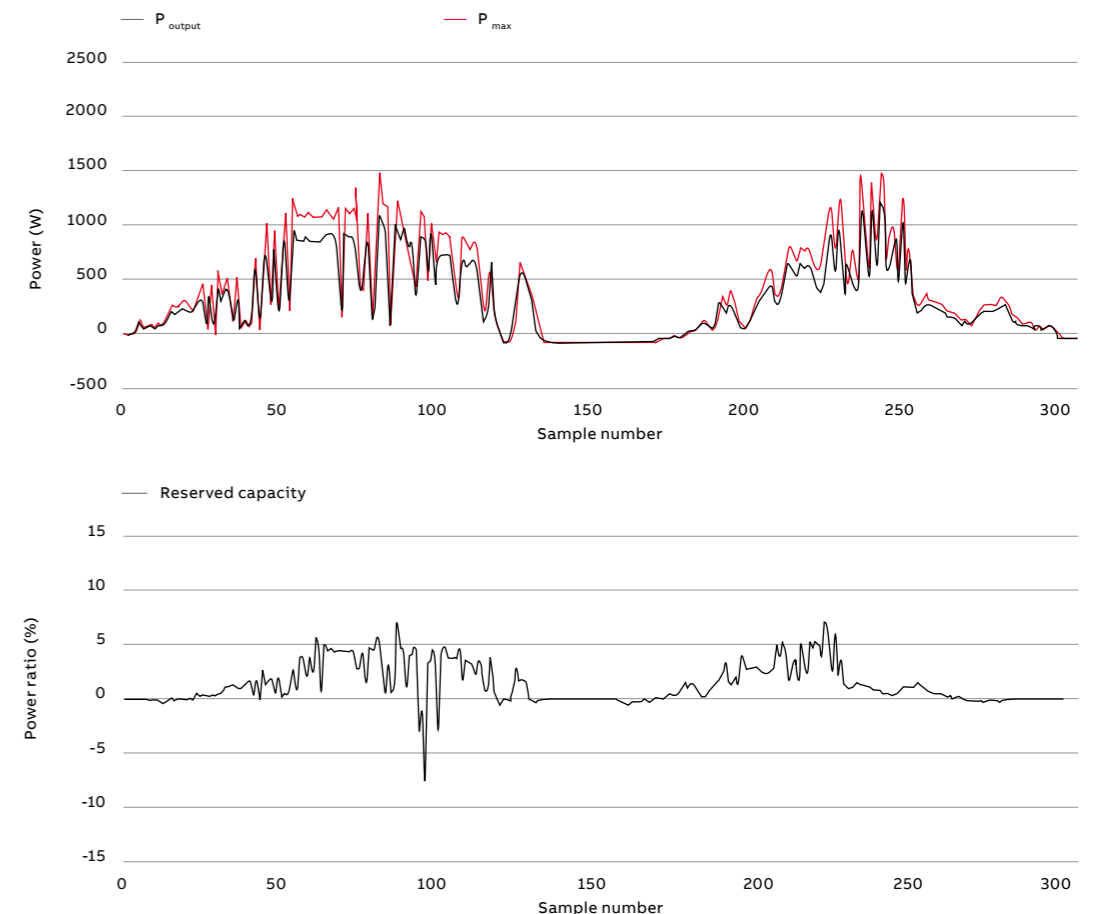

03

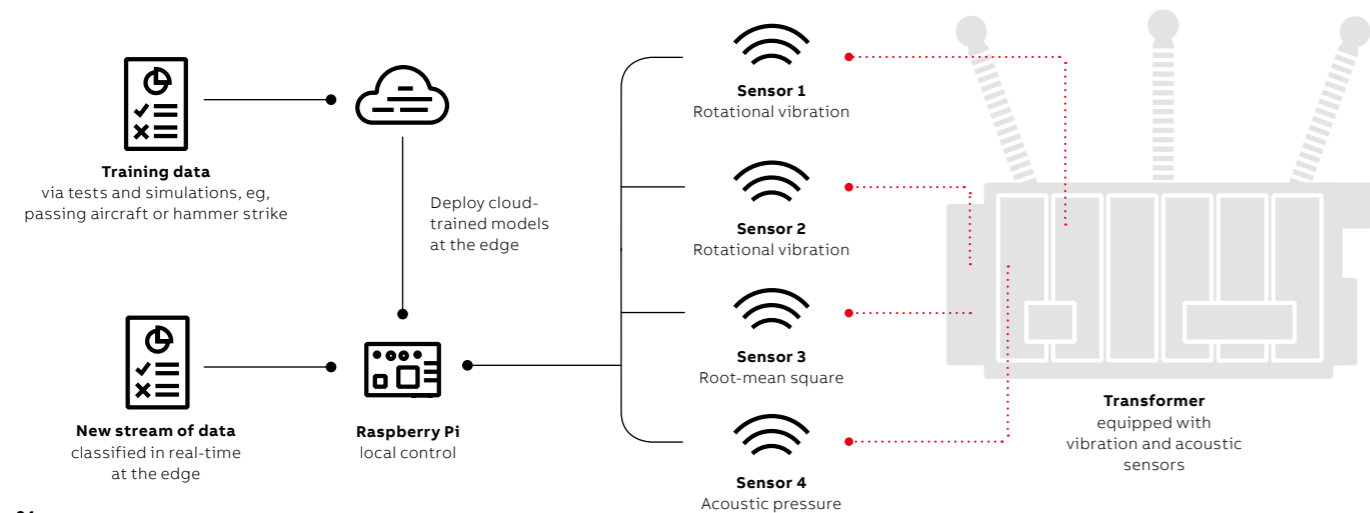

04

The objective was to score the machine-learning model against the incoming data stream. The output from the model was the class of impact: benign (eg, aircraft flying over) or malignant (eg, hammer strike).

In the experiments on this representative use case, the performance varied noticeably between a Linux virtual machine with eight cores (2.1 GHz) that was proxy for a high-end edge gateway and a quad-core (1.2 GHz) Raspberry Pi 3 Model B. The performance also varied notably in transitioning from pure data ingestion to model scoring. It is likely that performance can improve with code optimization. However, the order of magnitude difference between monitoring and scoring mode would be significant for time-sensitive applications.

Semi-autonomous plant electrical system assessment

In this use case, safety in a food and beverage (F&B) plant was twinned in the cloud using image recognition. Using images (hazardous and nonhazardous scenarios) of the plant from past safety assessments, deep convolutional neural nets were trained in the cloud to automatically detect electrical hazards. These neural nets can then be deployed on the plant operators' smartphones or video cameras on the plant floor for real-time hazard detection →5.

Deep learning is the newest addition to the artificial intelligence (AI) toolbox. Deep learning made it into the hype cycle in 2017 for the first time following

a breakthrough in training algorithms and error rates. Deep learning can be applied on a digital twin at the edge to recognize electrical and food safety hazards in F&B facilities.

While deep learning has been long known and applied extensively for cloud-level applications such as image processing, natural language processing and speech recognition, its application at the edge is quite novel, especially given the computational requirements.

A trained model could be cost-effectively deployed at the edge – another example of the synergistic use of edge and cloud technologies for analytics and machine learning.

Corrosion was chosen as the hazard category as it is the number one issue in F&B facilities and one for which ABB had a reasonable training data set (with hundreds of thousands of training variables). Google TensorFlow and Keras libraries were used for training various deep learning networks. As is common in analytics projects, the quantity and quality of training data played a significant role in the accuracy of the classification results. A 90 percent accuracy, in the best-case scenario, was achieved, which demonstrates the potential

- 04 Streaming analytics on vibro-acoustic sensor data for power transformer physical security.
- 05 Deep-learning framework for safety hazard recognition.

for using machine intelligence. As a reference, the benchmark human recognition rate for images is 95 percent.

A hardware demonstrator was built using a \$35 single-board computer (Raspberry Pi Model B). The deep-learning models were developed in a GPU (graphics processing unit) cluster and deployed on the Pi for real-time scoring. Python libraries were extensively used in this exercise. This experiment proved that deep learning is not necessarily an expensive and exclusive technique for cloud-computing applications. Its application at the edge is quite feasible and can motivate many use cases that rely on image and other high-dimensional data. The ultimate goal was to demonstrate that a trained model could be cost-effectively deployed at the edge. This achievement serves as another example of the synergistic use of edge and cloud technologies for analytics and machine learning.

As edge computing technologies advance, one should expect edge execution of digital twins to bring benefits in many use cases.

Cutting edge

Although this article concentrates on edge execution of digital twins, the take-home message should be understood as “edge-cloud synergy” and not “edge versus cloud.” As edge computing technologies advance, one should expect edge execution of digital twins to bring benefits in many use cases, including, but not limited to, smart grids, smart cities, smart plants, robotics, the IoT and smart transportation. •

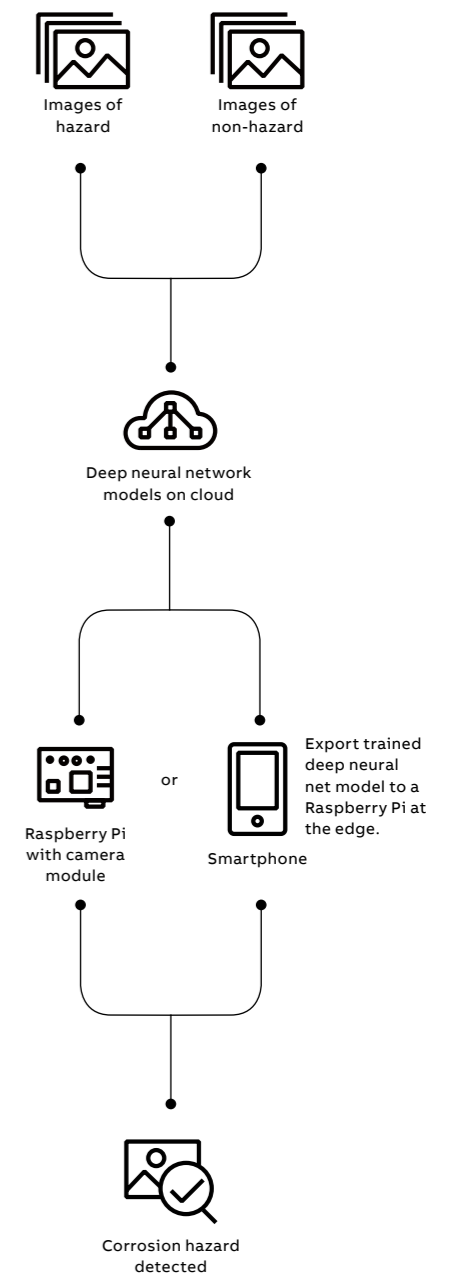

05

DIGITAL TWINS AND SIMULATIONS

Electrothermal simulations improve equipment thermal design

Power grid equipment should be compact and efficient – but should also handle extreme thermal stress. Digital design methods are indispensable in achieving this aim. Recent breakthroughs in electrothermal simulation have made the technique a valuable tool for the power equipment designer.

—
Jörg Ostrowski
Andreas Blaszczyk
 ABB Corporate Research
 Baden-Dättwil, Switzerland

joerg.ostrowski@ch.abb.com
 andreas.blaszczyk@ch.abb.com

—
Boguslaw Samul
Remigiusz Nowak
 ABB Corporate Research
 Krakow, Poland

boguslaw.samul@pl.abb.com
 remigiusz.nowak@pl.abb.com

—
Michael Gatzsche
 ABB, High Voltage Products
 Zurich, Switzerland

michael.gatzsche@ch.abb.com

—
Valeri L. Oganezov
 ABB Electrification Products,
 Saint-Laurent,
 Quebec, Canada

valeri.l.oganezov@ca.abb.com

Pressure to be compact and efficient, and the demanding and varied power landscape in which it operates, makes thermal stress a critical design consideration for modern grid equipment. In order to predict thermal stress in a power device or system, it might seem sufficient to calculate electromagnetic behavior and heat transfers.

—
New tools mean that thermal stress in power devices can nowadays be predicted with high precision and comparatively low effort.

However, for a successful, comprehensive calculation, many physical effects must be considered and simulated – a task that overwhelms traditional heuristic design approaches. A digital design approach must be taken.

New tools for simulation and co-simulation

Whereas resistive and inductive losses, and heat conduction, have been computable for some years, the important losses at electrical contacts or the mixed convective-turbulent-radiative heat transfer

01a

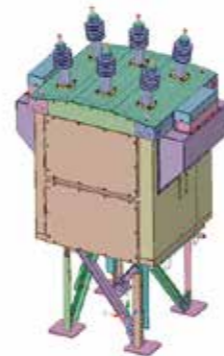

01b

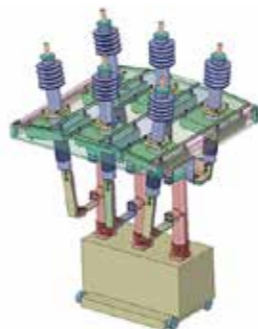

01c

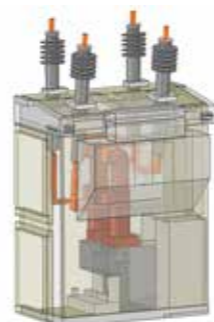

—
 01 MV outdoor arc-resistant circuit breaker.

01a Outer view.

01b Inner components.

01c Simplified model for thermal subanalysis.

—
 02 The demands made on power grid equipment, such as the ABB power transformer shown here, are unprecedented, which makes thermal stress a significant design consideration. Electrothermal simulations are a valuable tool for any designer of power grid devices.



02

mechanisms at the surfaces of realistic devices became predictable in a precise way only recently thanks to Maxwell-CFD (computational fluid dynamics) co-simulation. Sophisticated mapping algorithms, automatic mesh refinement and error control are important numerical companions of such simulations. These new tools mean that thermal stress in power devices can now be predicted with high precision and comparatively low effort.

The integration of large parts of such simulations into a CAD system, as was accomplished for the ABB Simulation Toolbox in recent years, now allows the relatively simple execution of complex simulations. Parametrized CAD-integrated simulation models allow the quick and accurate analysis of a multitude of possible product variants under different loads. ABB was a pioneer of these CAD-based simulation twins, which will be employed for engineering in the digital factory of the future [1].

In particular, ABB pioneered advanced, comprehensive methods for electrothermal calculations, which are critical for the successful design of modern power equipment. A number of

—
ABB pioneered advanced, comprehensive methods for electrothermal calculations, which are critical for the successful design of modern power equipment.

such methods are already in use by ABB's product designers. The choice of method depends on the simulation task and three examples serve to give a flavor of the power and flexibility of the approach.

Maxwell-CFD co-simulation of a medium-voltage outdoor breaker

One of the most accurate and detailed methods for computing electrothermal processes is based on two-way-coupled Maxwell-CFD co-simulation. Here, the electromagnetic power losses are calculated by a finite element solver of Maxwell's equations and the heat transfer is computed by a CFD solver. The two solvers exchange information during the calculation in such a way that all electrothermally relevant effects can be considered.

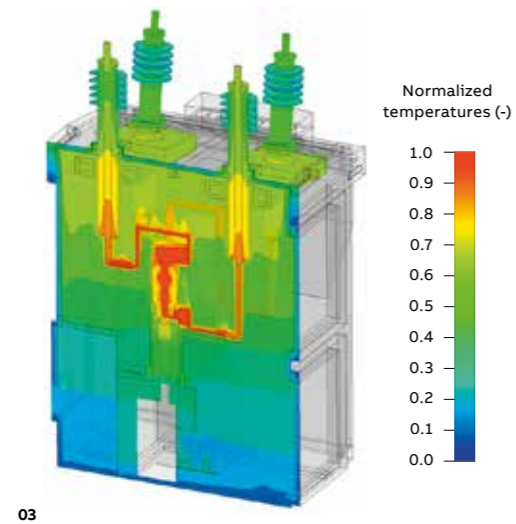

The usage of the two different meshes for the two different physical domains enables a resolution of local phenomena that might otherwise be impossible. In the case of convective cooling, examples of these phenomena are skin effects that concentrate the power losses close to the surface of the conductors and thin turbulent boundary layers at the outer surface of the solids that are decisive for the heat transfer to the environment.

ABB researchers developed effective computational tools to conduct such a highly complex simulation. A 3D electrothermal analysis of an arc-resistant outdoor medium-voltage (MV) circuit breaker can be used as an example →1.

Circuit breakers are one of the most important components of MV power distribution networks as they ensure proper load switching and protect downstream loads and upstream networks, including major items such as power transformers.

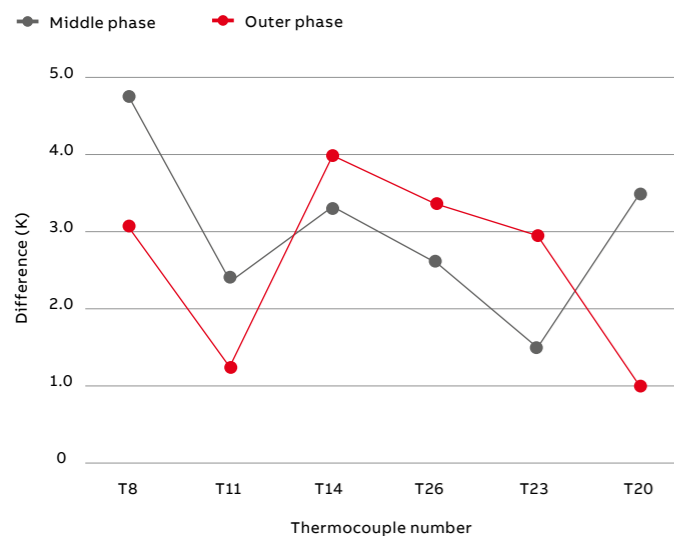

04

The thermal behavior of the circuit breaker is a vital factor in its operation. Overheating during normal operation may shorten its life and damage main components. Overtemperatures caused by overloads may damage the breaker insulation and lead to electrical breakdown.

One challenge was that forced cooling is not allowed during breaker overload but, nonetheless, the unit is expected to reliably operate between -50 and +40 °C (the unit is designed for up to 60 percent overload at extremely low temperatures, for instance). The thermally insulated enclosure - designed to IP43 - has well-protected ventilation grids, which limit air circulation and thus reduce the effectiveness of convection cooling. This aspect further complicates the design process and may lead to multiple design iterations and retests.

The complete simulation process included all physical effects that occur during the standardized heat test.

Devices such as circuit breakers have their thermal behavior verified during temperature rise tests that require controlled environmental conditions, a physical model of the device, a suitable power supply and a test infrastructure (thermocouples, etc.) A test may take many hours to reach a stable temperature. Of course, such a test procedure is indispensable for the final type testing of a device, but it is an expensive way to test early design variants, some of which may be discarded anyway.

In contrast, computerized virtual temperature-rise tests enable very fast and relatively inexpensive validation of different breaker designs under a variety of loads and environmental conditions.

The simulation model of the MV circuit breaker in →1 includes electromagnetic and thermal (CFD) submodels that exchange data. In the electromagnetic model, even if the device has geometrical symmetry, current paths of all three phases are considered, on a account of the asymmetrical current loads and proximity effects. Thermal-flow simulation was performed for only half of the device, thanks to its geometrical planar symmetry.

The complete simulation process included all physical effects that occur during the standardized heat test. In the case of electrical losses, and skin and proximity effects, the influence of temperature on material resistivity as well as electrical contact resistances were considered. For thermal calculations, turbulence effects in buoyancy-driven

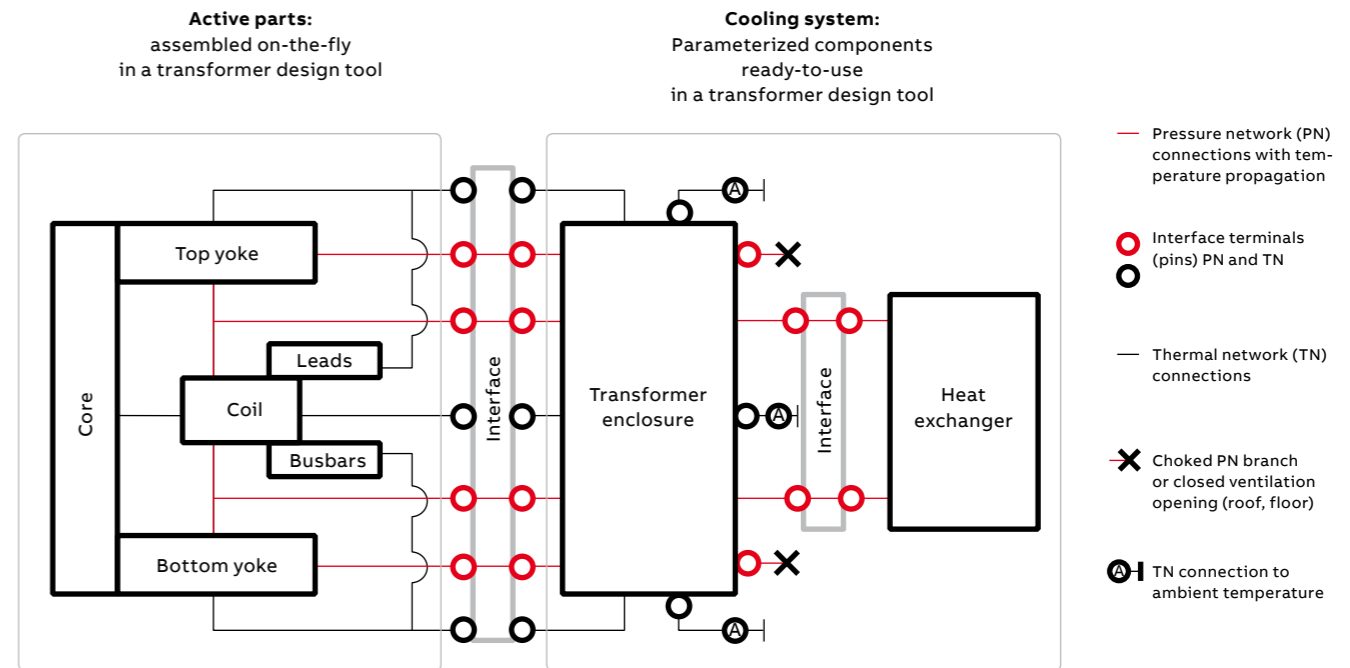

05

- 03 Final temperature distribution inside an MV outdoor circuit breaker.
- 04 Simulation accuracy – comparison with physical measurements.
- 05 Modular network concept, connecting active parts with components of the cooling system.
- 06 Velocity plot in a dry transformer enclosure with major air streams denoted by white arrows. This 2D axisymmetric CFD Fluent simulation was performed with an internal fan as well as ventilation grids in the walls and roof.

flow together with thermal radiation were taken into account. Other details, such as the influence of ventilation grids on air exchange between the breaker interior and ambient environment, were also included.

Coupled simulation is an iterative process and data was exchanged between the two solvers until a stable temperature (± 5 percent) was reached, which took four iterations. With a maximum deviation of 5 K, simulation results matched actual temperature rise test results almost perfectly →3,4. This example illustrates how simulation can deliver reliable results and reduce the number of real test iterations.

Network model of a dry transformer

It is not always possible to use the computationally expensive Maxwell-CFD co-simulation, especially for large complex design devices or if one is aiming for automated design optimization. In such cases, simplified analytical descriptions are used, eg, thermal equivalents to electrical circuits – the thermal networks. Such networks are not necessarily precise but are computationally much more efficient.

With a maximum deviation of 5 K, simulation results matched actual temperature rise test results almost perfectly.

Traditionally, the thermal network approach has been used to evaluate the temperature rise of transformer coils [1] →2. Recently, developers of the ABB transformer design tool extended the network model and enabled computations of the whole cooling system [3] →5. The active parts that generate heat are connected with the cooling system via a predefined interface that allows the transfer of fluid and heat between components. The cooling system includes an enclosure as well as an external heat exchanger with another interface between them. The interfaces make it possible to combine all implemented network components and define an arbitrary configuration according to designer specifications. Standalone

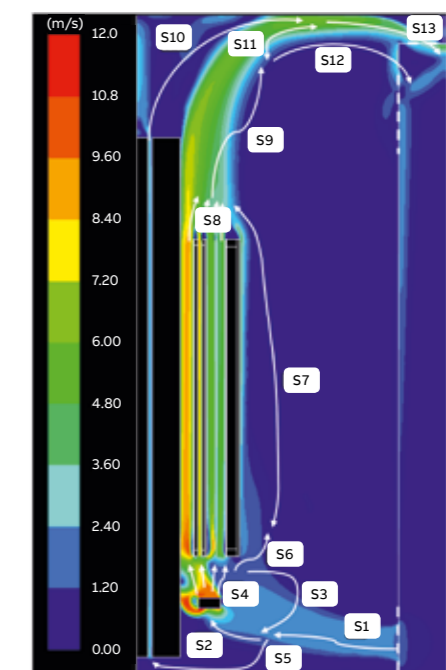

06

transformer operation (without enclosure) and open ventilation (as a replacement for the heat exchanger) are included as available options.

As an example of component implementation, a pressure network model of a dry transformer enclosure is shown in →6,7. The streams of air identified in a CFD computation have been used to create the network topology. The CFD result has been used to validate the accuracy of the network model within the required parameter range. Typical parameters are: dimensions of the enclosure, internal fan data and flow resistance of ventilation grids. The network model can reproduce the circular flows inside the enclosure.

The full model can compute coil temperature rise, taking into account all details of winding, core and

The full model can compute coil temperature rise, taking into account all details of winding, core and the cooling system, within seconds.

the cooling system, within seconds This approach allows designers to keep within the required temperature limits and minimize material costs.

Simulation of short-time current test of an earthing switch

Mandatory short-time current (STC) tests drive a high current of short duration (some seconds) through a device to mimic a short-circuit and thus test the device's withstand capability. As STC tests are elaborate and costly, STC simulations that reliably predict the temperature rise in the device are valued.

A Maxwell-CFD co-simulation approach here would be overkill as the heat flux from the device to its environment is low. In fact, the entire CFD part can be represented as simple transient heat conduction in solid parts of the device. Of much higher importance for STC tests is electromagnetic modeling. The major effects that need to be considered here are:

- Ohmic losses in the volume of the device.
- Temperature dependence of the electrical resistivity.
- Ohmic losses due to electric contact resistances (ECRs) at conductor interfaces.

The latter effect is the most complicated and cannot be neglected because these losses may amount to up to 50 percent of the overall losses. In addition, in switches, the losses occur locally at the surfaces of the electrical contacts and are not distributed throughout the entire volume (as is the case for ohmic losses within the material).

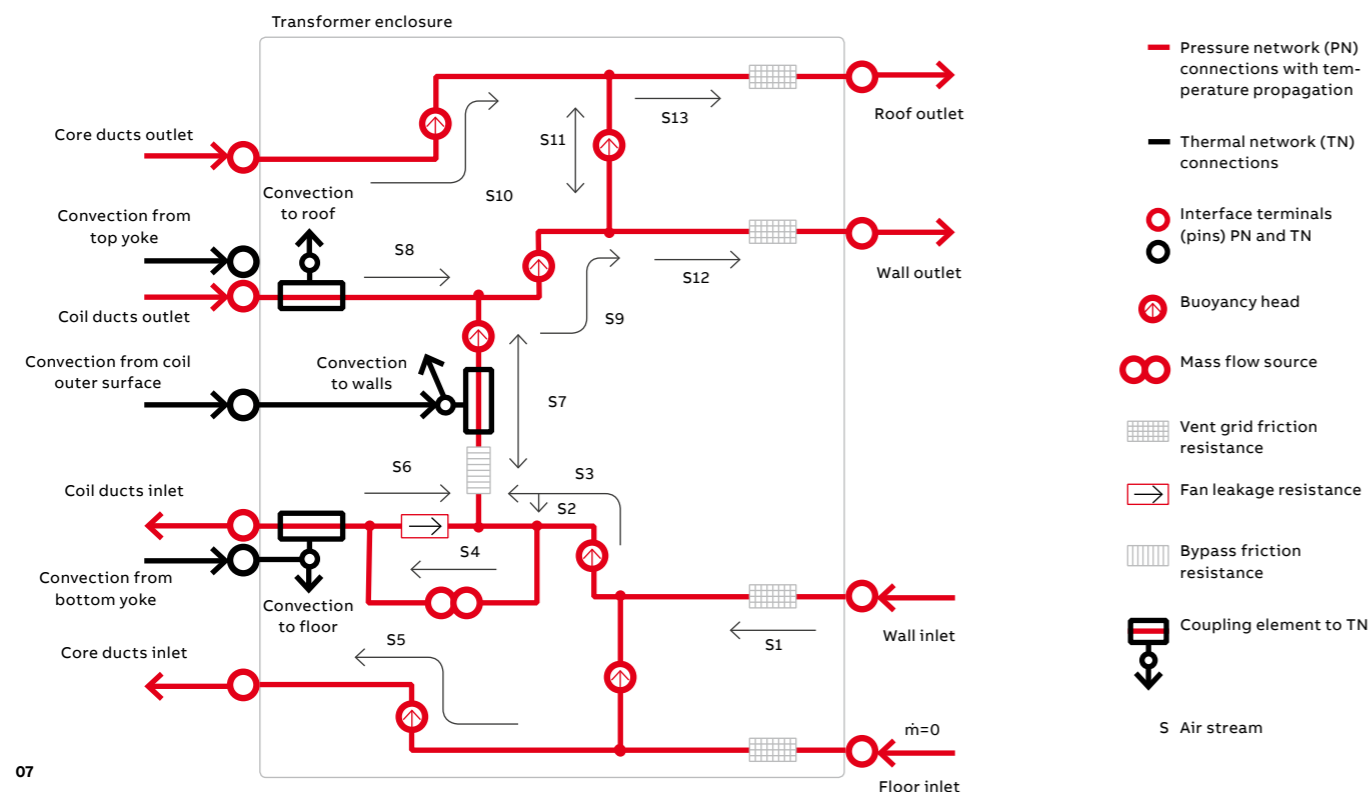

07 Pressure network with airflow branches (black arrows) corresponding to CFD results from →6. Temperature propagation wires, as well as the thermal network, are not shown (only the coupling PN/TN is) [3].

08 A section through the hottest part after 3 s. Everything in green or blue is below the melting point (835 K, black); everything in red or yellow is above the melting point.

09 Maximum temperature found during the two simulated STC tests. With a 63 kA test current, the melting point (835 K) is not exceeded; at 80 kA it is exceeded after 1.8 s.

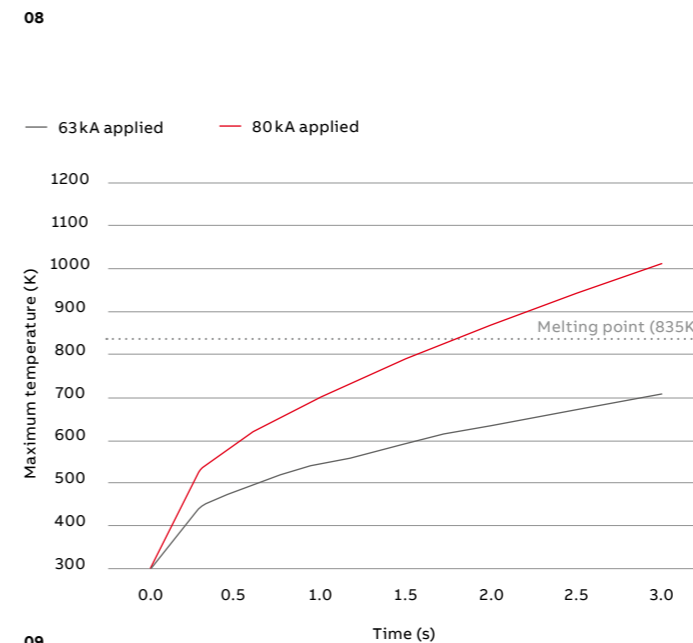
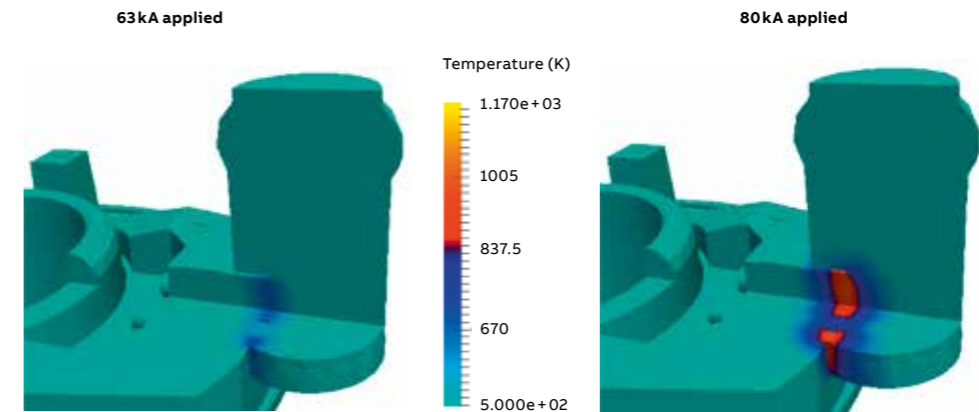

09

References

[1] A. Blaszczyk et al., "Simulation Toolbox – Dielectric and thermal design of power devices," ABB Review 3/2013, pp. 16–21.

[2] R. Nowak et al., "A 3D electro-thermal simulation of the outdoor medium voltage circuit breaker," IEEE Transactions on Power Delivery (in review process).

[3] A. Cremasco et al., "Network modelling on dry-type transformer cooling systems," COMPEL – The international journal for computation and mathematics in electrical and electronic engineering, Vol. 37, Issue 3, 2018.

[4] J. Ostrowski et al., "Simulation of short time current tests of industrial devices." Accepted by SCEE 2018, Springer Series "Mathematics in Industry."

Consequently, the hottest and most vulnerable areas are in the neighborhood of the electrical contacts. Modelling of ECRs is a multiphysics topic extensively studied worldwide.

In the simulation of a gas-insulated switchgear (GIS) earthing switch, a constant – ie, temperature-independent – contact resistance was assumed [4]. This is the simplest representation of a contact for which the increasing electrical (material) resistivity during heat-up is compensated for by a decrease of the contact resistance due to a larger contact area caused by material softening.

The real-life prototype passed the 63 kA test but failed after approximately 2 s in the 80 kA test, closely reflecting the simulation results.

Two STC tests – in which RMS currents of 63 kA and 80 kA, respectively, were driven through the earthing switch for 3 s – were simulated and also carried out in the laboratory →8,9.

The real-life prototype passed the 63 kA test but failed after approximately 2 s in the 80 kA test, closely reflecting the simulation results. A new 80 kA design was developed.

Modeling the future

As electrothermal simulation tools improve further and co-simulation becomes easier and more powerful, better model resolutions will be possible and models will reproduce the real-life device experience even more closely. Power equipment is going through a period of great change due to trends such as digitalization, distributed generation, inter-regional power transfer and the effects of highly variable renewables. The more powerful and more sophisticated simulation and co-simulation tools under development will find good use. •

DIGITAL TWINS AND SIMULATIONS

HVDC Light® digital twin facilitates EMC design

ABB's validated simulation models accurately reproduce entire HVDC Light substations and associated wiring. EMC investigations can be performed reliably during the design, commissioning and operation phases – increasing uptime and reducing costs.

—
Didier Cottet
Bernhard Wunsch
 ABB Corporate Research
 Baden-Dättwil,
 Switzerland

didier.cottet@ch.abb.com
 bernhard.wunsch@ch.abb.com

—
Göran Eriksson
 ABB Corporate Research
 Västerås, Sweden

goran.z.eriksson@se.abb.com

—
Wojciech Piasecki
 ABB Corporate Research
 Cracow, Poland

wojciech.piasecki@pl.abb.com

—
Gustaf Sandberg
Jenny Skansens
 ABB Grid Systems, HVDC
 Ludvika, Sweden

gustaf.sandberg@se.abb.com
 jenny.skansens@se.abb.com

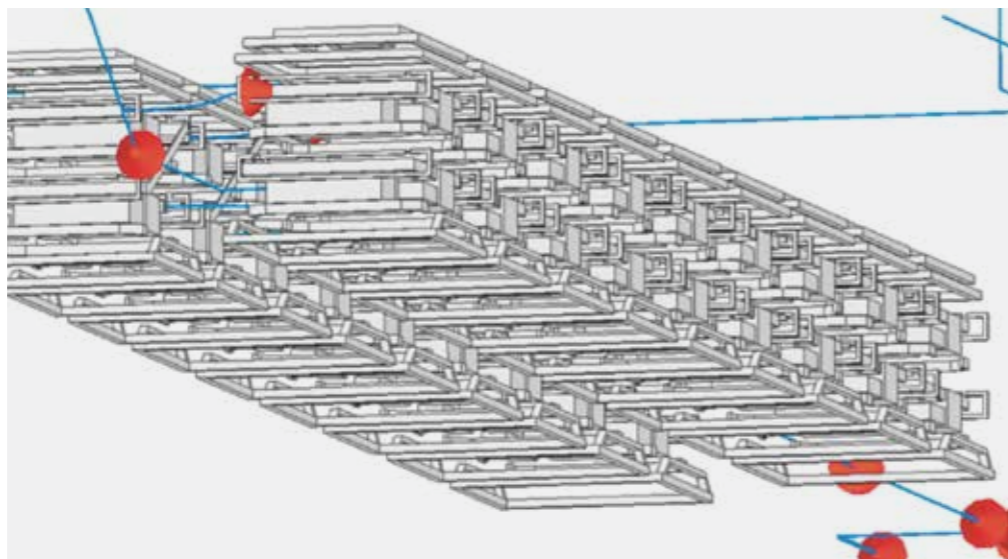

01

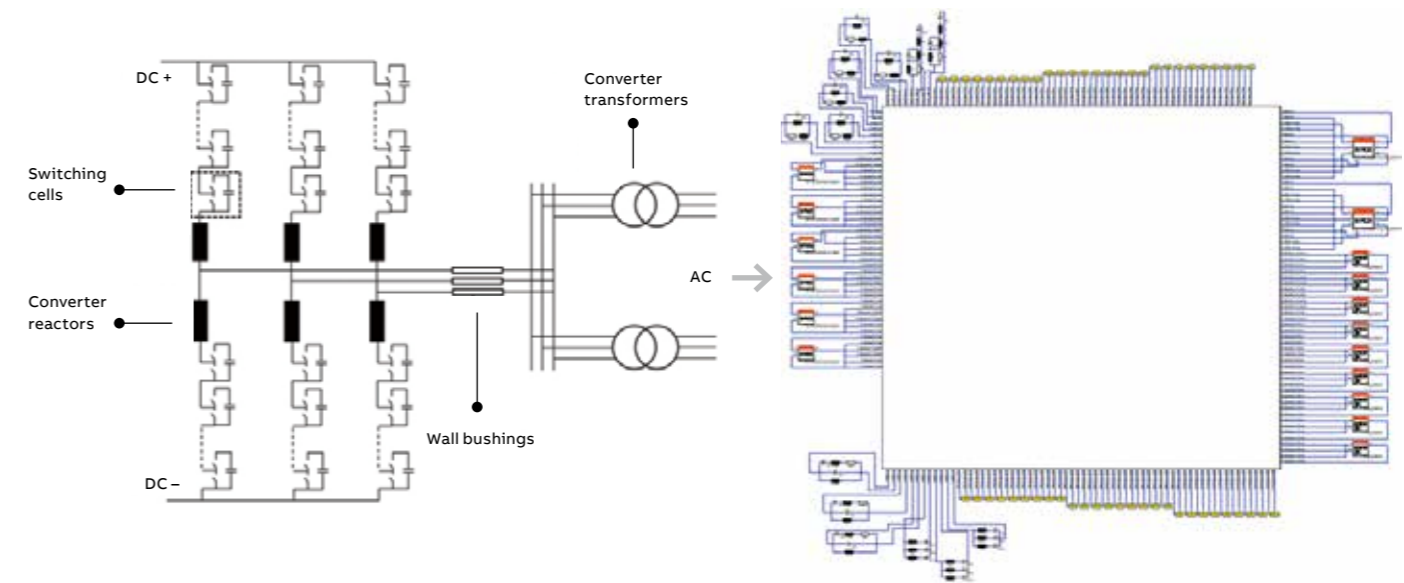

02

—
 01 HVDC Light valve hall and a screenshot of its 3D digital twin in CST.

—
 02 An HVDC Light converter topology with the circuit of its digital twin in CST.

The electromagnetic compatibility (EMC) of new products is determined to ensure that equipment, typically sensitive electronics, operate as intended in the electromagnetic environment encountered. Concurrently, devices conducting current shall not emit unacceptable levels of electromagnetic energy or cause interference to other equipment or electronic devices located nearby or at a specific distance. In a typical workflow, experts

—
ABB applied advances in numerical methodology to address EMC design at the earliest possible stage of HVDC Light converter station project development.

build product prototypes and measure the electromagnetic radiation in dedicated anechoic or reverberation chambers. Nowadays, large EMC test facilities exist that accommodate entire aircraft. There are no such possibilities for HVDC Light® substations or medium- and high-voltage facilities. Instead, laborious, costly EMC measurements are made on-site after commissioning. Performing measurements at this late stage drastically limits options for implementing design changes if EMC problems arise during fulfillment of requirements. In addition, electromagnetic disturbances from other sources are often present on-site: this can lead to strongly distorted, unreliable results.

ABB, a pioneer in HVDC Classic® for more than 60 years, introduced HVDC Light technology in 1997. Currently, HVDC Light has an important role in renewables, providing a transmission capacity of up to 3000 MW. Ever oriented toward the future, ABB applied advances in numerical methodology to address EMC design at the earliest possible stage of HVDC Light converter station project development. ABB's smart simulation models, or digital twins, reproduce the entire converter stations including valves, valve hall, converter reactors, wall bushings, converter transformers, high frequency (HF) filters and the entire wiring in the AC- and DC-yards. Digital electromagnetic twins allow a wide range of EMC related investigations to be performed reliably during the design, commissioning and operation phases:

- Impact of semiconductor switching on HF disturbance characteristics
- Control algorithms and system dimensioning (ie, cell voltage and current ratings)
- HF filter optimization and positioning
- Design variants for components, component placement, bus bar and cable layout
- Shielding effectiveness of building construction

Substation model – the digital twin

In 2014, ABB initiated a project to model a HVDC converter station using CST Microwave Studio® (MWS), a commercial, numerical electromagnetic (EM) full-wave tool. Particularly useful for rapid accurate analysis of high frequency components, CST MWS allows 3D modeling of systems, sub-systems and components, including buildings and

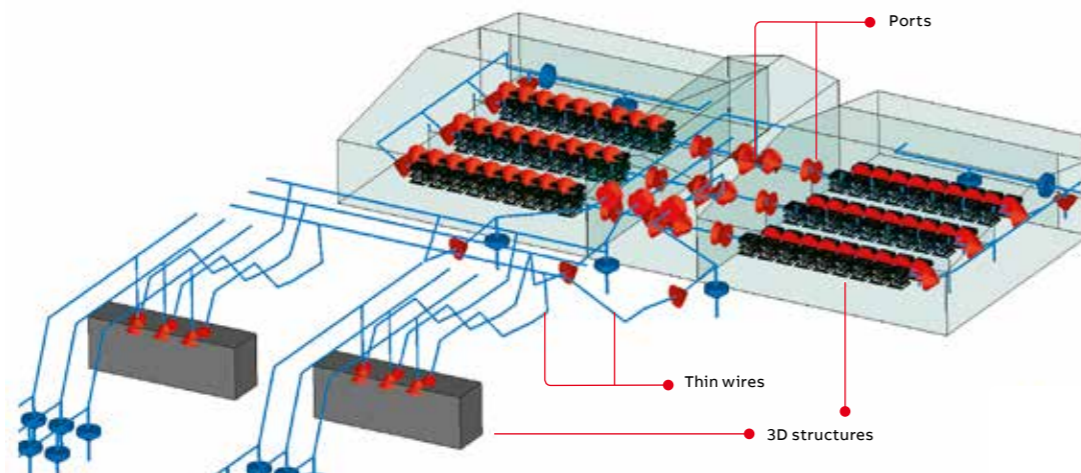

03

HV buses →1. Station components such as instrument transformers, breaker and power conversion functionalities, converter topology, and switches, are connected to the 3D model in a dedicated schematic view. This function allows rapid and accurate visualization of the complex models →2.

Modeling methodology

The CST simulation environment, which is embedded in a dedicated, systematic workflow, consists of procedures and tools for creating component models for the pre-processing stage and for analyzing the simulation result during the post-processing stage. All models and sub-models can be created at an early design stage, typically

significantly earlier than when physical components are actually available – a crucial advantage.

—
In 2014, ABB initiated a project to model an HVDC converter station and its components using CST Microwave Studio®.

The system-level model of the entire station is excited →3 at the different physical locations where the actual HF disturbance is generated. A voltage impulse function is injected that results in the propagation of HF currents within the station.



04a

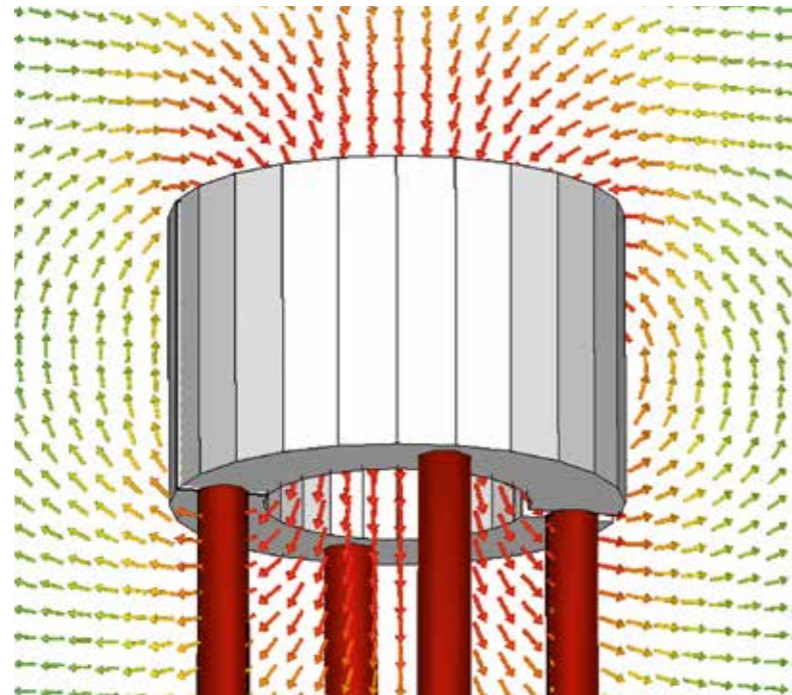

04b



05a



05b



05c

—
 03 A 3D CST model of a full HVDC Light station.

—
 04 High frequency impedances of an air core reactor are reproduced beautifully.

04a An air core reactor.

04b The resultant simulated magnetic field pattern of a similar phase reactor is shown.

—
 05 ABB's model is validated through high frequency measurements of equipment and components.

05a Validation of an HVDC transformer.

05b EM radiation measurements are made at near-field inside an AC yard.

05c EM radiation measurements are also made at far-field, located 200 m from the converter station.

The resulting impulse response of this time domain simulation can be transferred to the frequency domain, thus gaining a broadband system response spectrum, which can be garnered for various observation points eg, H-field probes, and current probes. Next, the impulse responses can be convoluted with the actual converter switching waveforms and processed with an electromagnetic interference receiver detector model. The results are directly comparable to values obtained by measurements of the electromagnetic radiation at an existing converter site.

—
ABB performed extensive high frequency measurements at the component and system level that validated the simulation results.

ABB employed a transmission line matrix solver with specific features that are particularly well-suited for this type of simulation. The 3D models support a combination of 3D structures and so-called thin wires that have much smaller cross sections than the mesh element size usually used →3. Furthermore, component boundaries for apertures, slots, etc. can be defined to effectively simulate shielding properties of enclosures and

valve-hall wall-types typically installed by utilities. Finally, lumped circuits can be added to the 3D model where more complex circuit sub-models of components can be connected via user-defined ports. Here lumped circuit elements and complex netlists can be connected. By combining various types of representation of particular elements of the system, complexity is reduced and simulations are more time-efficient.

Nevertheless, to be a powerful tool, simulations must accurately reproduce the high frequency impedances of components in the AC- and DC-yard of the stations eg, converter reactors →4, converter transformers, wall bushings and instrument transformers. In-depth information about system and component modeling justifies its use in converter station modeling [1,2].

Validation

To influence product realization, intelligent modeling relies on physical measurements. ABB performed extensive high frequency measurements at the component and system levels that validate the simulation results, thereby affirming the fitness of the twin →5. The measured and simulated HF disturbance in the near-field (within the AC yard close to the HVDC converter) →5b and far-field, (at a position of 200 m from the AC yard) →5c are in excellent agreement in terms of the predictability of critical peaks →6.

Design advantages

Electromagnetic compatibility design and performance is effected by many system-level parameters. ABB not only meets all EMC challenges, but it improves EMC. A simulation model enables utilities to make crucial EMC design choices at the earliest possible stage. The ability to optimize early rather than late results in significant cost reductions and lower downtime. This contrasts with the highly problematic task of implementing changes once critical on-site measurements have been made. Such changes, if at all possible, are associated with huge costs and require operations to be shut down for necessary reconstruction.

Additional applications

Because aspects of EMC design include filters, shielding and switching characterization station layout, apparatus design, and grounding system, etc, ABB applied EMC simulation models to these products, processes and systems to enhance availability and reliability →7.

— Models that closely approximate their physical product or plant twin enhance the ability to make key decisions rapidly – supplying value to an enterprise.

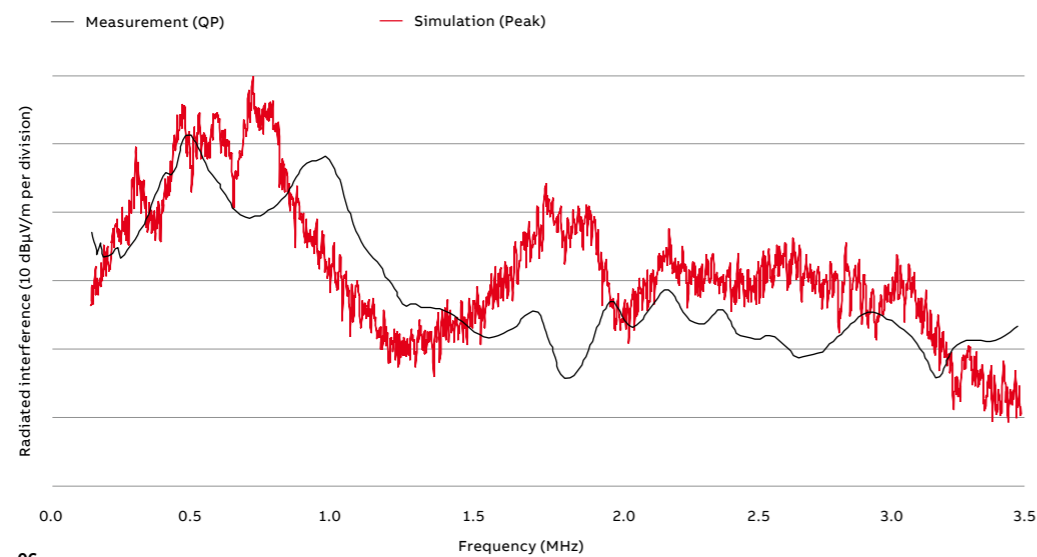

06

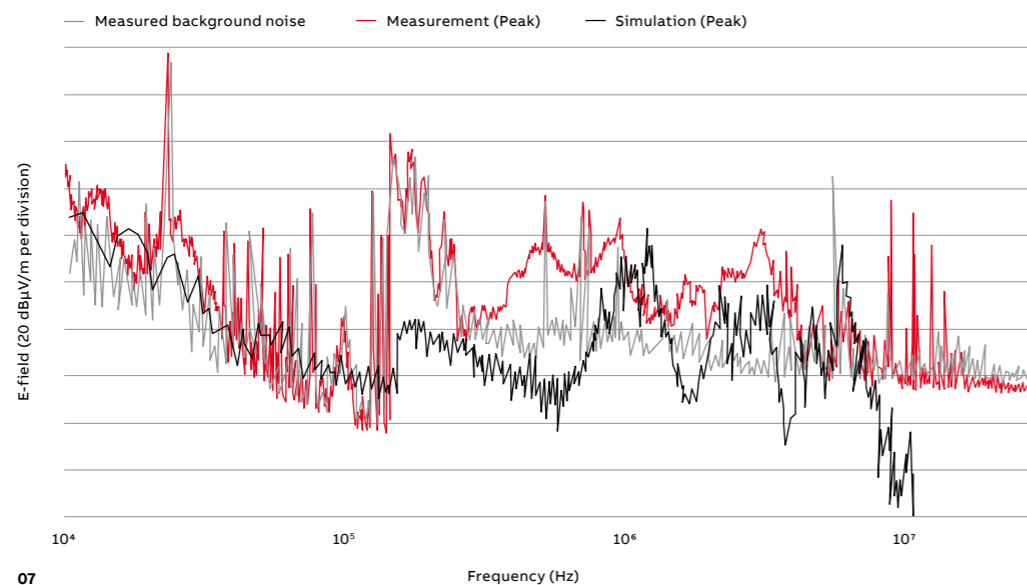

07

— 06 A comparison of near field measurements and simulation is shown.

— 07 Comparison of far field measurements and simulations that take into account background noise.

— 08 Magnetic field distributions in an HVDC converter station were tested.

08a Magnetic field distributions before optimization of the HF filter design.

08b Magnetic field distributions after optimization of HF filter design.

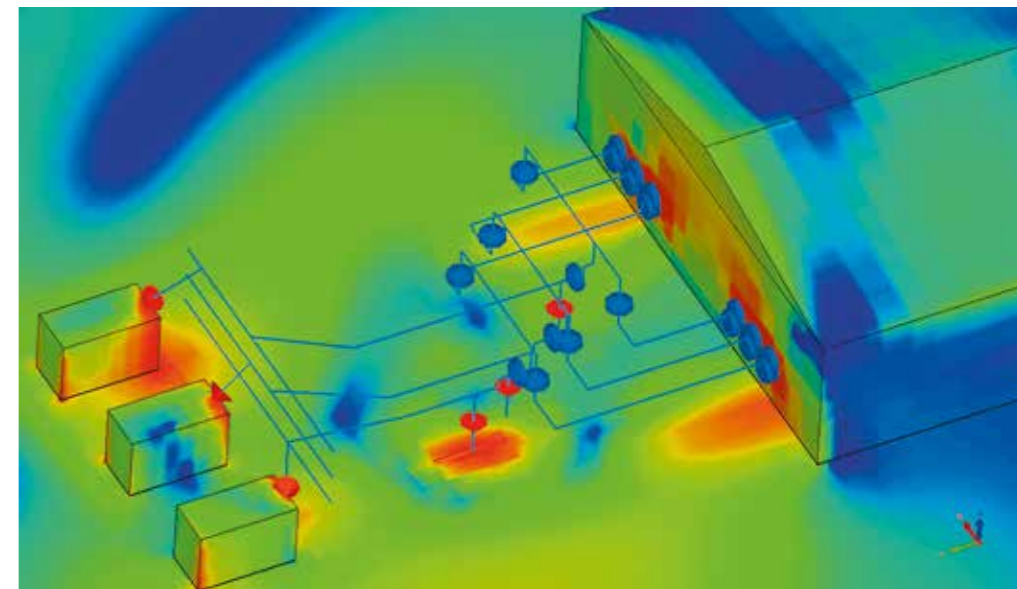

08a

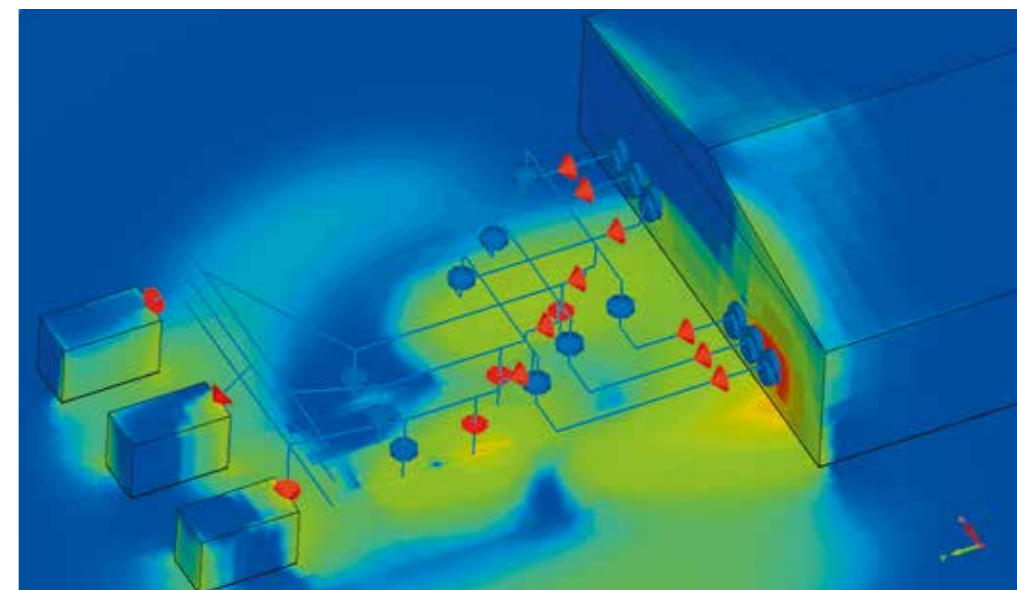

08b

EMC filter design

Product success often depends on how quickly a product reaches the market. EMC filters are crucial for this process: The best possible filter design can save time during certification and reduce production costs. ABB investigated the optimization of EMC filter design with regard to filter equipment and filter placement in an HVDC converter station. The simulated magnetic field at 5 MHz for the initial filter solution was designed without the help of 3D simulations →8a and compared with that of a 3D-model aided design. Not surprisingly, the 3D-model optimized filter displayed a significant reduction in field amplitude →8b. Furthermore, similar field-level reductions were seen across the entire frequency range investigated. More importantly, in one case the use of the 3D simulation model resulted in lower costs and significant performance improvement. ABB’s smart 3D-model enhanced filter design performs better, at

a potentially lower cost. Most significantly, the level of detail made available from the 3D simulation enables recognition of possible EMC issues in the future – performance predictability is possible.

— ABB investigated the optimization of EMC filter design because filter optimization is crucial to product success.

In today’s fast-paced environment of tenders and projects, decisions for novel solutions often need to be made on the fly. Models that closely approximate their physical product or plant twin greatly facilitate the ability to make key decisions rapidly – supplying value to an enterprise.

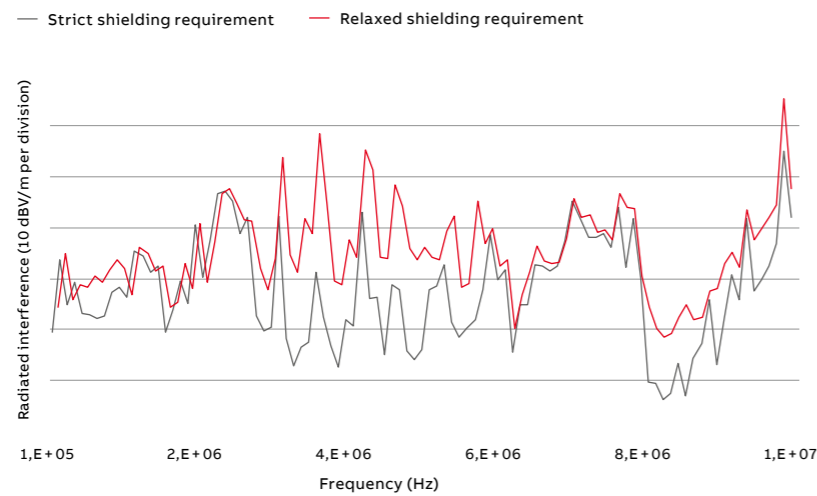

09

Building design and on-site installation done properly and efficiently, early, add great value. Shielding, in particular, is of paramount importance to business value. Buildings function to prevent strong direct emissions, which emanate from the valve structure, from reaching the outside world. For an HVDC converter building, bushings, doors, vents etc, are necessary for the converter to function but will reduce the shielding efficiency of the building because they create openings in the EMC shield or Faraday cage. Moreover, metallic wall cladding eg, overlapping sandwich panels with aesthetic, practical surface treatments, are usually free from electric contact. The inclusion of a seemingly small window can reduce the effectiveness of the shield by orders of magnitude in an otherwise perfectly designed building. Currently, 3D simulation models provide the best opportunity to optimize shielding requirements early and translate the requirements into practical details, thereby reducing the risk of costly and time-consuming modification work on-site at a later phase. Shielding requirements can also have a strong effect on radiated interference →9.

Accordingly, ABB ran two simulation models on the shielding of the valve hall: one with strict requirements and another with relaxed

requirements →9. The distance between screws provides the electrical connection between wall panels →10. For strict shielding requirements, this distance is an order of magnitude less than for relaxed requirements. The greatest differences are found above a threshold frequency of about 2–3 MHz →9. These results, together with EMC requirements and deep knowledge of the susceptibility of equipment to electromagnetic disturbance located close to the power station, can enable utilities to make better decisions about shielding requirements.

—
3D simulation models provide the best opportunity to optimize shielding requirements early, thereby reducing the risk of costly, time-consuming work on-site at a later phase.

Even though modeling examples are taken from HVDC applications, the same EMC simulation methodology can be applied to other medium- and high-voltage applications introduced by ABB eg,

—
09 ABB tested the impact of radiated interference within a valve hall. This figure shows a comparison of radiated interference for strict and relaxed requirements on valve hall shielding.

—
10 The distance between screws provides the electrical connectivity on a wall panel and varies with regulation severity. A valve hall wall; the distance between screws is indicated.

FACTS, SVC Light® and Rail SFC Light®. ABB, with its long-term commitment to innovation in the power sector, will continue to introduce innovation like the HVDC Light digital twin technology to change how products are created, realized and evolve. ABB's ability to perfect EMC demonstrates commitment to customers. Improving power station uptime by increasing the availability and reliability of critical components and systems that might affect electromagnetic performance is just one way ABB accomplishes this today. •

Acknowledgments

This article would not have been possible without the ideas, effort and dedication of the entire project team and stakeholders. The authors would like to extend their special thanks to: Filip Grecki, Arne Schröder, Pawel Kryczynski, Szymon Piela, Magdalena Ostrogorska, Celine Tigga and Olof Andersson.

References

[1] D. Cottet, G. Eriksson, M. Ostrogorska, J. Skansens, M. Wunsch, F. Grecki, W. Piasecki and O. Andersson, "Electromagnetic modeling of high voltage multi-level converter substations," in Proc. of the Asia-Pacific Intl. Electromagnetic Compatibility (APEMC) Symposium, Singapore, 14–17 May, 2018.

[2] B. Wunsch, D. Cottet, G. Eriksson, "Broadband models of high voltage power transformers and their use in EMC system simulations of high voltage substations," in Proc. of the Asia-Pacific Intl. Electromagnetic Compatibility (APEMC) Symposium, Singapore, 14–17 May, 2018.



10

—
ABB's HVDC Light digital twin technology will change how products are created, realized and evolve in the future.

DIGITAL TWINS AND SIMULATIONS

Managing solar asset performance with connected analytics

ABB recently executed several research initiatives capitalizing on digital twins for asset performance management. Approaches for assets with short histories and long histories were developed. These analytics and tools are now being productized and deployed in managing asset health and performance.

—
Karen Smiley
Xiao Qu
Travis Galoppo
K. Eric Harper
Alok Kucheria
Mithun P. Acharya
Frank Tarzanin
 ABB Corporate Research
 Raleigh, NC, United States

karen.smiley@us.abb.com
 xiao.qu@us.abb.com
 travis.galoppo@us.abb.com
 eric.e.harper@us.abb.com
 alok.kucheria@us.abb.com
 mithun.acharya@us.abb.com
 frank.tarzanin@us.abb.com

This article highlights selected elements of the work ABB has recently conducted on several related research initiatives that capitalize on digital twins for asset performance management. Discussed first is an “agile analytics” approach that jump-starts the creation of useful health and performance analytics for new devices or materials that do not yet have long monitoring, operational or environmental data histories. The second topic of discussion is an ongoing initiative to leverage a long history of intracloud data collection for

—
Avatars or twins provide value in several scenarios, including planning, deployment, operation and maintenance.

solar inverters and plants to create new analytics for event and weather correlation as well as for benchmarking, forecasting and self-service business intelligence (BI). These analytics and tools are now being productized and deployed for internal and customer use in managing asset health and performance.

Industrial asset performance management (APM)
 Efficiently keeping critical long-lived assets healthy and performant is essential to success. Analytics play an increasingly important role in understanding and optimizing asset health and

performance. Active APM enables customers to increase operational awareness of the health and performance of enterprise assets. Heightened health awareness empowers customers to move from costly reactive maintenance towards risk-based management techniques that optimize performance and maximize return on net assets (RONA). While there are many ways to quantify the health of an asset, most algorithms reflect its risk of failure (RoF) and its remaining useful life (RUL). However, typically, these health key performance indicators (KPIs) alone do not reflect performance degradation, which can impair production and RONA long before actual failure or end of life. Accordingly, comprehensively managing asset performance also requires analytics that quantify productivity and degradation.

Digital twins for APM

Connected assets underpin a coordinated approach that marries operational technology (OT) and information technology (IT). Digital avatars or digital twins that blend OT and IT data can be thought of as reflections of real-world objects for combining models of devices. This does not mean they need to be exact clones; they merely need to reflect the most important asset behaviors to be explored. These digital avatars or twins can empower faster creation of analytic models that integrate asset metadata and operational data (eg, telemetry and events) with data on the asset’s environment (such as weather, irradiance, lightning, operational



01

—
 01 Digital-twin-based analytics can detect gradual or storm-related degradation in solar plants and prevent lost power production long before it would otherwise be noticed and addressed. Such asset health and performance management analytics and tools fully exploit the availability of large quantities of data.

conditions), for characterizing and managing asset performance at the device and plant levels. The avatars or twins provide value in several scenarios, including planning, deployment, operation and maintenance. One major benefit is safe and nonintrusive exploration of “what-if” scenarios – eg, to simulate how possible actions to tune health or production would affect the devices and system.

Asset performance analytics for solar

Penetration of renewable energy is increasing around the world, as is demanded for a reliable and sustainable energy supply. For over 13 years, ABB has designed and manufactured a broad range of solar photovoltaic (PV) inverters spanning the needs of residential, commercial, utility-scale

—
One major benefit is safe and nonintrusive exploration of “what-if” scenarios – eg, to simulate how possible actions to tune health or production would affect the devices and system.

and microgrid applications [1]. As of 2017, ABB’s installed base of solar inverters worldwide exceeded 26 GW. To support connected solar analytics, these inverters are becoming more intelligent and more easily integrated with complex and smart environments →1.



02

The ABB Ability™ Aurora Vision Plant Management Platform [2] complements ABB’s inverter portfolio with a cloud-based solution for next-generation management of solar PV plants →2. Aurora Vision automatically collects monitoring data from solar inverters and other devices, and provides highly interactive, real-time access to key performance and operations metrics to optimize inverter performance and inform business decisions. The monitoring data collected over the past 13 years spans more than 250,000 devices in solar plants worldwide →4.

For solar, the PV panels, inverters, meters, environmental units, energy storage, plant and power grid can all be modeled with digital twins. These facades provide access to measurements, estimates and analytics results based on an understanding of the physics and engineering of the underlying systems, and operating experience.

Understanding asset condition and performance
Predicting asset behavior, production, events, RoF, RUL, etc. are all becoming increasingly important in understanding the true condition of an asset and how best to maximize its value. The three key, interrelated, concepts are degradation, RoF and RUL →3. Degradation in the physical or logical condition of an asset decreases RUL and increases RoF but can be mitigated by maintenance actions to enhance production and performance prior to failure or end of life.

Using a digital twin, one can analyze asset data to characterize asset production, condition and degradation; estimate RUL; quantify RoF; and assess the potential impact of maintenance actions. Analytics can be applied predictively to drive proactive preventive maintenance decisions or to gain a better understanding of failures that have already occurred.

Classifying analytics algorithms

To aid in selecting analysis approaches depending on the available data, algorithms relevant to each concept have been classified. For example, RUL algorithms were grouped under the headings of directly observed, indirectly observed, and state processes and machine-learning, while RoF algorithms were grouped as failure tracking, symptom monitoring and detected error reporting. Many other types of analytic algorithms can also be useful: For example, anomaly detection is a key aspect in augmenting failure prediction models and forecasting can be highly valuable for proactive asset load management. These algorithm types have also been classified. Some of the detailed classifications are shown in →5,6.

Classifying and mapping available data

Data types, volumes and varieties are critical to applying these algorithms effectively. For instance, if telemetry or event data are not available with sufficient time resolution, certain RoF algorithms based on early detection of anomalies are not applicable. Assessment of “data readiness” for an analytics application can provide valuable insight for choosing which algorithms to apply. →6,7 show an example from a tool ABB developed to characterize data availability with respect to data requirements for a class of analytic algorithms. Understanding these relationships can guide efficient development of new asset analytics in an agile, iterative way that maximizes the benefit of the available data.

— Analytics can be applied predictively to drive proactive preventive maintenance decisions or to gain a better understanding of failures that have already occurred.

The analytics collaboration also cataloged various data imputation strategies for handling missing values and borrowed from previous forecasting experience using neural networks. These methods help offset some concerns relating to limited data completeness or quality when developing new algorithms for analyzing and managing asset health and performance.

— 02 ABB Ability Aurora Vision Plant Viewer for Mobile.

— 03 Relationships among degradation, RoF, RUL and maintenance.

Intracloud analytics architecture

Identifying and blending many additional types of data proved highly beneficial for creating useful digital twins for solar inverters and plants. The Aurora Vision solar monitoring platform already provided a rich set of metadata about solar plants and the equipment used in them, as well as streaming telemetry and event data sent to the cloud [3]. Some plants also include on-site environmental stations that record weather and solar irradiance →4. This data was supplemented by weather, lightning and irradiance measurements gathered by off-site sources [4–6]. Using these off-plant sources extended the plant coverage of weather data: One off-site weather source provided useful data for 50 percent of the plants where on-site weather stations were absent.

Complementary textual, numeric and complex data was also acquired from other systems available inside and outside ABB [7]. The inclusion of free-form text enabled the use of natural language processing (NLP) techniques to build a better understanding of sequences of events, whether those events were reported by customers or logged automatically by the Aurora Vision system.

Combining this data with the telemetry and event data enabled new analytics to benchmark and predict inverter performance, and led to a better understanding of the impact of environmental conditions on solar inverter reliability, availability and yield. Similarly, the augmented digital twin for the solar plant helped to drive new analytics that deliver fresh insights into plant performance. As an example, mixing failure modes from field engineering reports with telemetry data like device alarms, temperatures and environmental conditions allows ABB to correlate categorized component failures with the signals seen in the field before devices fail. This intelligence provides early warnings or predicts when a failure rate threshold may be exceeded.

— Identifying and blending many additional types of data proved highly beneficial for creating useful digital twins for solar inverters and plants.

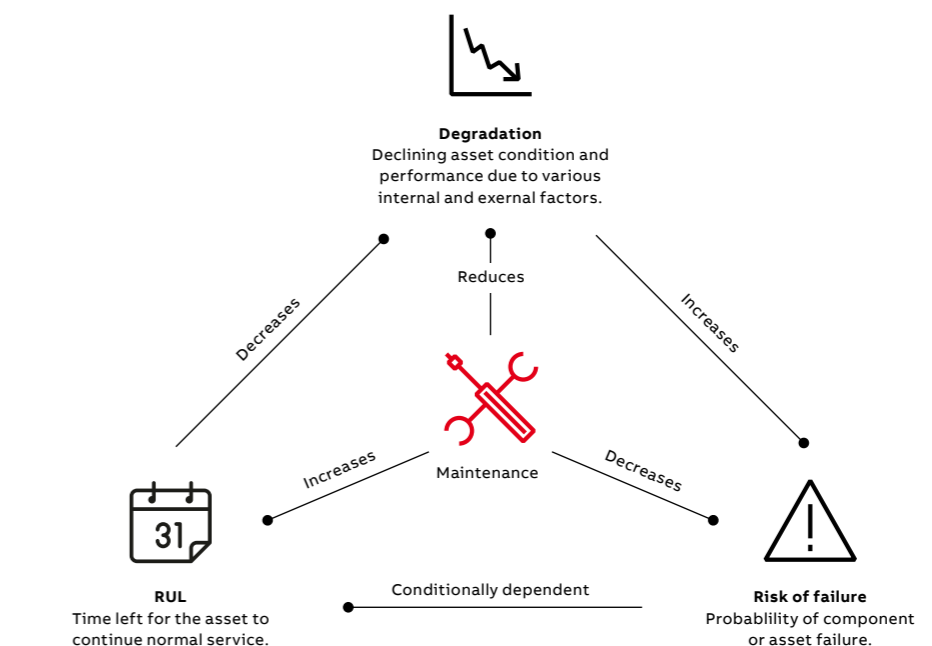

03



04

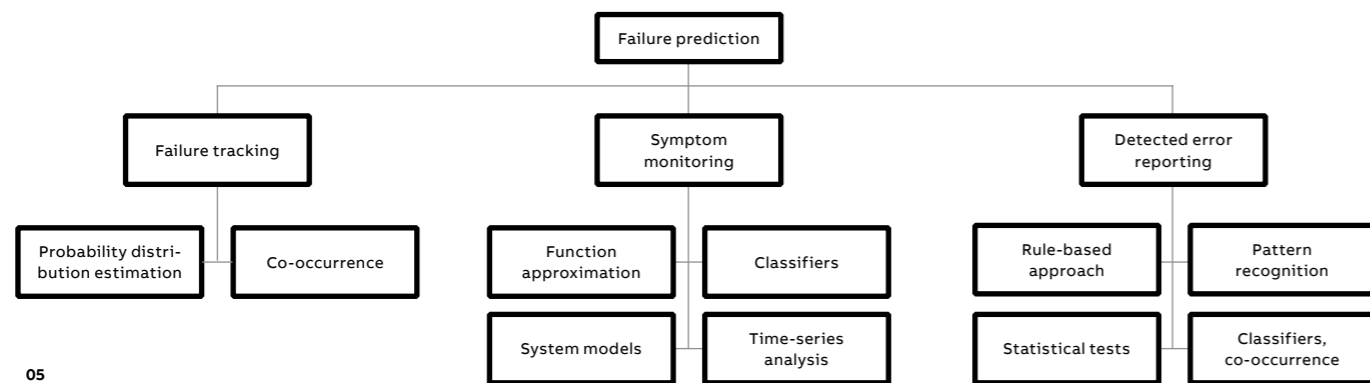

05

— 04 Some solar plants include on-site environmental stations that record weather and solar irradiance.

— 05 Classification of RoF algorithms.

— 06 Classification of RUL algorithms.

The augmented digital twin for the solar plant helped to drive new analytics that deliver fresh insights into plant performance.

preparing for storm impacts. In the longer term, such findings can justify preventive actions such as installing additional lightning protection in the plant or creating more accurate capital and maintenance plans.

Visual self-service analytics

In visual analytics, self-service BI tools are employed to illustrate various data – including metadata, telemetry data and event data – using figures, maps and other charts. The BI tools can automatically fuse multiple data sources and types via common fields. Information is easily tailored for different user requirements and interests through interactive filters and selections, and all selections made to one chart are applied to other artifacts automatically, in real time. These features help owners and operators of solar plants to visually identify anomalies and obtain other insights efficiently and effectively.

Weather analytics

The blending of this diverse data amplified the variety and power of the performance analytics. For instance, weather data from off-plant sources enhanced detection of anomalous readings from in-plant environmental stations. →8 shows a comparison of total daily irradiance in 2016 between two data sources, an in-plant environmental unit and an off-plant sensor. This anomaly detection analysis improved the accuracy of cloud, edge, or hybrid analytics relying on weather readings as inputs, such as estimating or/and predicting power generation for inverters. In turn, this enhanced the ability to detect gradual or sudden degradation of panel or inverter performance that could impair solar plant production.

Concrete benefits from the solar APM work

Achievements from the solar collaboration included novel algorithms for benchmarking and forecasting solar inverter performance and reliability; prototypes for visual self-service BI applications; edge algorithms for real-time estimates of AC output and DC input power; automated

These findings can provide valuable guidance to solar plant operators or service personnel in assessing RoF and RUL and taking appropriate actions. Short-term actions might include

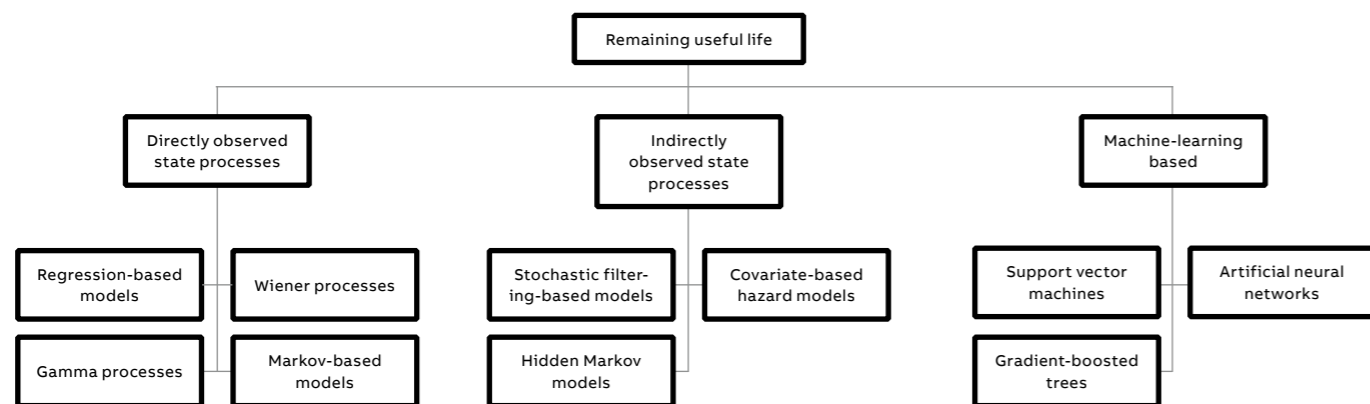

06



diagnostic tools for service engineers for analyzing events, telemetry and free-text customer correspondence; and new KPIs that can help ABB's customers to better understand (and gain more value from) their solar plants. The project also demonstrated the synergistic value of an intracloud analytics architecture aligned with ABB Ability that leverages complementary internal and external data sources. Environmental data was also shown to augment the business value of the analytics.

Early prediction of failures with analytics provides valuable lead time for performing maintenance or acquiring and installing a replacement.

These capabilities are now being integrated into ABB's portfolio of solar monitoring and asset performance solutions.

As an example of the potential business value of these analytics, consider an industrial solar plant with 10 TRIO 60 kW solar inverters. Digital-twin-based analytics can detect

gradual or storm-related degradation varying across the plant (which may be addressable by simple cleaning), preventing lost power production over the many days or weeks before it would otherwise be noticed and addressed. Unexpected failure of one inverter in a plant with 10 inverters means losing about 10 percent of the plant's solar power production, which could subject the plant operator to regulatory penalties for failing to meet renewable power production commitments. Early prediction of failures with analytics provides valuable lead time for performing maintenance and, if necessary, for acquiring and installing a replacement device or the right parts. Actual monetary benefits are situational and can be calculated based on days of lead time, whether hot spares are available in the plant, avoidance of multiple service trips by bringing the most-likely failed components, and factors such as regulatory penalties and the value of electricity in the region.

07 Example spider diagram illustrating data readiness.

08 Comparison of total daily irradiance measures between in-plant and off-plant weather stations for anomaly detection.

References

[1] ABB solar inverters. Available: <http://new.abb.com/power-converters-inverters/solar>

[2] ABB Ability™ Aurora Vision Plant Management Platform. Available: <http://new.abb.com/power-converters-inverters/solar/monitoring-and-communication/aurora-vision-plant-management-platform>

[3] M. P. Acharya et al., "Real-time AI powered by edge-deployed digital twins", pp 14–19.

[4] Earth Networks. Available: <https://www.earthnetworks.com>

[5] The Weather Company. Available: <https://www.ibm.com/weather>

[6] ABB Ability™ Velocity Suite. Available: <http://new.abb.com/enterprise-software/energy-portfolio-management/market-intelligence-services/velocity-suite>

[7] Salesforce. Available: <https://www.salesforce.com>

When much less historical data is available, creation of digital twins can be accelerated by leveraging the algorithm and data categories and associated agile analytics tools.

When vast quantities and diversities of data are available, much can be achieved. However, data is not free: Adding instrumentation and collecting, storing and transmitting data have capital and operational costs. When much less historical data is available, creation of digital twins for new types of industrial assets in an APM system can be accelerated by leveraging the algorithm and data categories and associated agile analytics tools.

These tools also support the cost/benefit assessment of proposed analytical strategies for newer asset types.

In all, the use of digital avatars or digital twins for solar APM brings a wealth of analytics and tools that provide multiple benefits for operators of solar PV plants. •

Acknowledgments

The authors gratefully acknowledge the valuable contributions of research team members James Ottewill, Marcin Firla, David Cox, Karl Severin, Imtiaz Ahmed, Hang Xu, Melwin Jose and Rohini Kapoor. We also note with appreciation the strong support of Filippo Vernia, Emanuele Figliolia, Antonio Rossi, Ronnie Pettersson, Siri Varadan, CJ Parisi and many others. Additionally, the authors warmly thank the ABB Ability Velocity Suite team, Earth Networks and The Weather Company for generously sharing supplemental weather data used in this research.

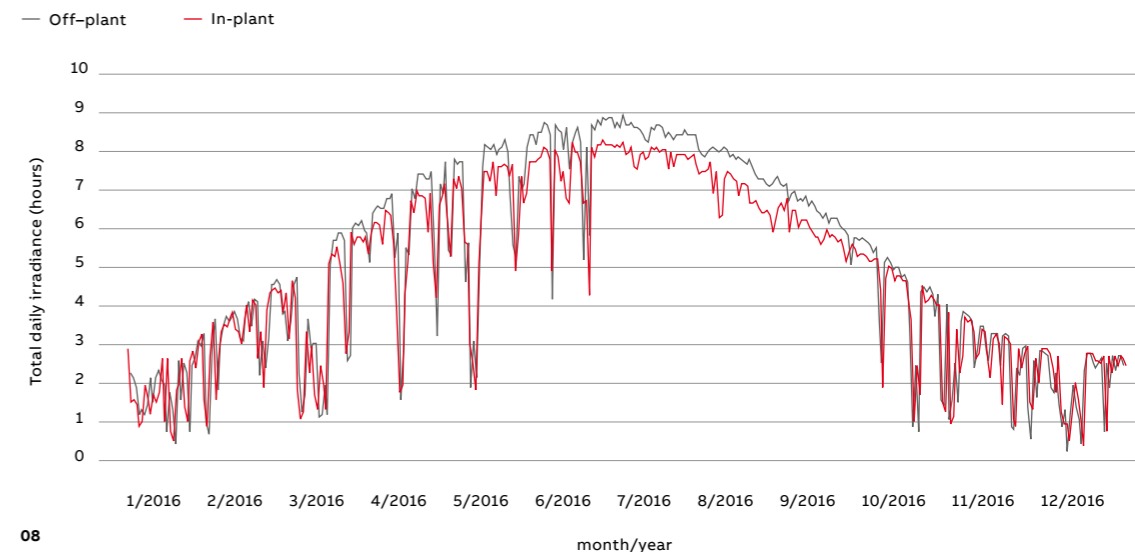

08

DIGITAL TWINS AND SIMULATIONS

Making simulations easy for engineers

Powerful tools such as computer-aided-engineering (CAE) and computational fluid dynamics (CFD) make it possible to rapidly perform virtual prototyping. However, the complexity of these tools limits their use to skilled users. A key driver of innovation is to democratize technology; with this in mind, ABB has introduced three semi-automated platforms designed to make numerical modeling quick, easy and reliable. The new tools reduce prototyping costs and enable dozens of design variation tests in a reasonable time frame.

01



Photo fig. 01: gordenkoff, istockphoto.com

01 ABB's latest simulation software uses computational fluid dynamics to capture the effects of turbulence, radiation and buoyancy, as well as the effects of geometrical details.

02 The concept of StudyTrafo's interface is to generate simulation models based on the input data of the mechanical dimensions of transformer components: core and yoke clamps, windings, tank and shielding.

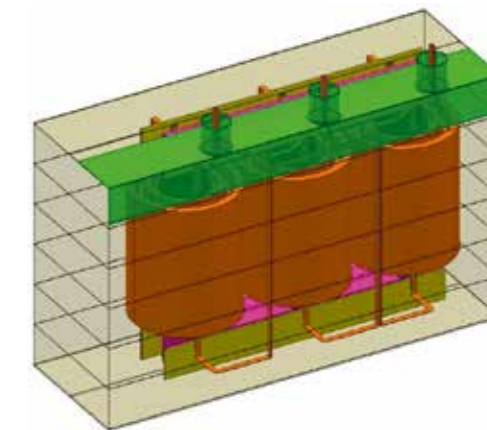

02

One of the key questions concerning electrical devices that are under development is the extent to which they will reduce costs both in terms of production and operation. On the one hand, there is a drive to reduce devices' weight, size and complexity; on the other, the devices must be robust, affordable and efficient. How can design engineers zero in on the best possible balance of factors for a given application in the least possible development time?

The answer to this question is complex because, for instance, reducing the size of an electrical device is limited by factors such as electrical distances (insulation properties) and its thermal management. But testing devices to ascertain their electrical and thermal properties is usually expensive and time consuming.

Nevertheless, there are powerful tools that can help device designers visualize, quantify and accurately predict a growing number of a device's characteristics during the development stage. For instance, computer-aided-engineering (CAE) tools, such as the finite element method (FEM) and computational fluid dynamics (CFD), can significantly reduce costs and testing times, as they enable creation of a virtual prototype of a device and analysis of dozens of its arrangements in a relatively short time →1. State-of-the-art simulation software, together with the growing computational capabilities of high-performance computers (HPC), enables virtual testing of complete devices with a level of accuracy that is within only a few percentage points of actual tests.

Three hurdles

This is not to say, however, that an era of flawless virtual product testing has arrived. Design engineers still face three significant hurdles: the cost of software, the cost of high-performance computers and an often insufficient familiarity with proper simulation model preparation and solver setups. But here again, solutions are at hand: Expensive commercial software can sometimes be replaced with open-source code, local HPC's can be replaced by cloud solutions, and model preparation

and solver setups can in some cases be performed by dedicated software with built-in templates and settings that do not require changes by the user. In this evolving landscape engineers can now get a user-friendly interface with a clear set of options and receive results in the form of a report. This approach, which is sometimes referred to as "simulation democratization," makes it possible for just about any engineer to use such an interface, rather than just a handful of numerical calculation specialists.

Computer-aided-engineering (CAE) tools such as the finite element method (FEM) and computational fluid dynamics (CFD) reduce costs and testing times.

How is ABB driving the trend toward affordable simulation tools that provide increasing value for its customers? Here's a look at three semi-automated tools developed at ABB for use in product development.

StudyTrafo

Verification of design and optimization of magnetic shielding are very important aspects of transformer production because of the need to reduce the stray losses generated in metallic parts exposed to magnetic fields. The preparation of associated numerical models requires deep knowledge of simulation software, skills in 3D modelling and experience in evaluating the results – skills that are generally relevant only to daily users of simulation

01
Boguslaw Samul
Andrzej Kobierski
Janusz Duc
ABB Corporate Research
Kraków, Poland

boguslaw.samul@pl.abb.com
andrzej.kobierski@pl.abb.com
janusz.duc@pl.abb.com

Jaydeep Deshpande
ABB Power Grids, Dry Transformers
Raleigh, NC, United States

jaydeep.deshpande@us.abb.com

Jan Westerlund
ABB Motors and Generators Technology
Helsinki, Finland

jan.westerlund@fi.abb.com

Dietrich Bonmann
ABB Power Grids, Power Transformers
Bad Honnef, Germany

dietrich.bonmann@de.abb.com

packages, but not always to electrical designers. In view of this, ABB has developed StudyTrafo, a semi-automated tool dedicated to the prediction of hot spots for simulation experts as well as for occasional users. StudyTrafo's interface makes the generation of simulation models easy to follow and very fast.

The concept of the interface is to generate simulation models based on the input data of the mechanical dimensions of transformer components – in other words, core and yoke clamps, windings, tank and shielding →2. Simulation models are generated in commercial software dedicated to electromagnetic and thermal calculations using built-in 3D primitives as blocks, cylinders, etc. and geometric operations.

Additionally, boundary conditions and simulation settings are automatically assigned to generated models. All the parameters are statistically fitted based on dozens of tested units and small, medium and large power transformers produced around the world by ABB. A material library dedicated to such calculations was developed by ABB scientists using laboratory measurements.

StudyTrafo allows engineers to provide a complete optimization of a transformer design within one day.

StudyTrafo is written in C# and input data can be entered manually by users or imported directly from a design system →4. The latter option allows instantaneous creation of simulation models. As a result, simulation time is relatively short, allowing engineers to provide a complete optimization of a transformer design within one day. Final results are presented in the form of a table showing the distribution of losses and maximum temperature values.

The methodology is practical and inexpensive. Compared to other tools and analytical methods available for stray loss calculations, the standard deviation between measured and calculated

structural losses has been decreased by a factor of two. Furthermore, the benefit of applying computer simulations is not limited to cost and time savings for a single transformer unit, but also results in a better understanding of the physical processes occurring during operation. Such an approach offers multiple benefits in terms of the opportunity to run simulation tests of different solutions. This results in improved designs with lower stray losses and greater efficiency.

CFD for MCCU

MCCU-CFD is a semi-automated tool dedicated to experimental CFD (computational fluid dynamic) simulations of electric motors →5. It was developed as a part of the MCCU (Multiphysics Cascaded Controlling Unit). The main idea behind the software is to control and automate several different physical phenomena commonly used by R&D engineers to study the operation of motors. This solution allows R&D design engineers to study how the alteration of the given dimensions or operational parameters of a motor influence the motor's approximated performance.

MCCU gathers multiple tools within a single interface, which can be accessed and used from a web page. The idea behind the tool is to allow R&D engineers to automate the process of preparing complete CFD simulations based on a predefined set of parameters.

The MCCU-CFD tool allows users to perform a CFD simulation of a motor with one click. The input for simulation is provided by ADEPT software – a comprehensive design environment for electric motors, and includes overall dimensions and motor operational parameters.

The tool generates a representative 3D model of a motor suitable for running an airflow or coupled thermal and airflow solution using open source utilities such as OpenFOAM →3. Once the scripts are finished with finite volume mesh generation of active parts and air domain they assure proper material property, heat source and boundary condition assignment for all motor components. Once a model is complete, simulation is calculated on a server until it reaches a stable

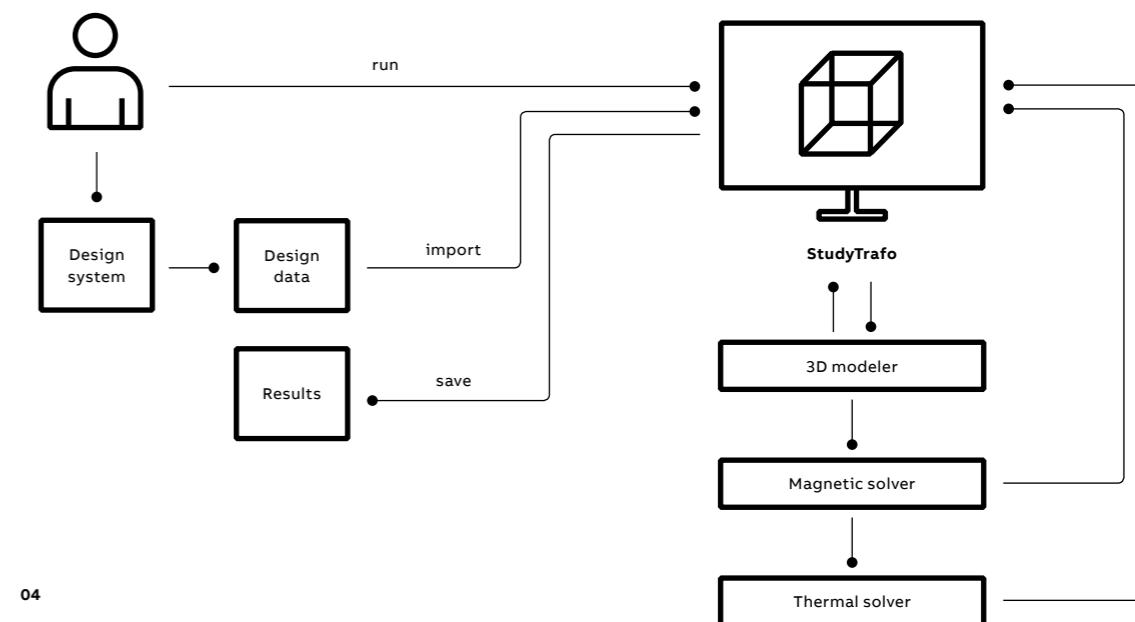
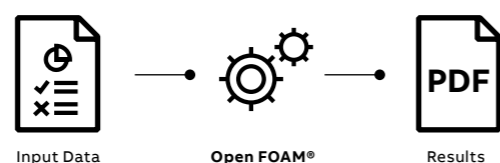

03 MCCU-CFD collects simulation results in the form of pictures, plots and tables and prepares a report for the user.

04 StudyTrafo's interface makes the generation of simulation models easy to follow and very fast.

05 MCCU allows R&D engineers to automate the process of preparing complete CFD simulations based on a predefined set of parameters.

state. At the end of the simulation process, automated post-processing is carried out using software such as ParaView. MCCU-CFD collects simulation results in the form of pictures, plots, and tables and prepares a report that is then sent to the user.

DryFOAM

Dry-type transformer designs are highly sensitive to temperature changes. Their thermal performance is characteristically worse than that of liquid-filled transformers due to their cooling medium (air) and to the fact that they use natural convection for heat transfer. In order to achieve optimized design for dry-type transformers, it is therefore imperative to have reliable thermal calculation tools at the designer's disposal.

The idea behind the MCCU-CFD tool is to automate the process of preparing complete CFD simulations based on a predefined set of parameters.

These tools can range from simplified lumped mass systems to very intricate network models. Going beyond the limitations of averaged parameter models, computational fluid dynamics allows users to capture the effects of turbulence, radiation and buoyancy, as well as the effects of geometric features on dry-type transformers.

With the advent of cloud computing, the cost of computation is now lower than ever. Hence, for a numerical analysis system such as CFD, cost of computation is no longer a bottleneck. Historically, the cost of commercial licensing has been a prohibitive factor in terms of widespread adoption of available platforms. In this new landscape, Open FOAM rivals commercial software suits as an alternate open-source software suite. Use of OpenFOAM makes it possible to scale simulations broadly across computational cores and truly leverage high performance computing at an ultra-low cost →6. For a repeatable task such as the design of a transformer, an automated platform based on OpenFOAM provides a good solution for accurate thermal calculation.

DryFOAM (Dry for dry transformer and FOAM for OpenFOAM) dates back to a 2016 workshop titled "Thermal Issues in Electrical Machines." Experiences exchanged in the areas of open source computing, thermal management, simulation software development and novel cloud computing methods at the time resulted in a 2017 IT project.

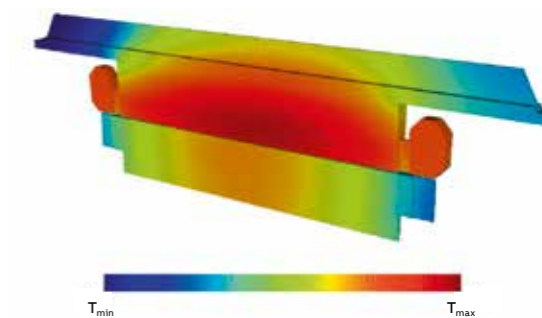

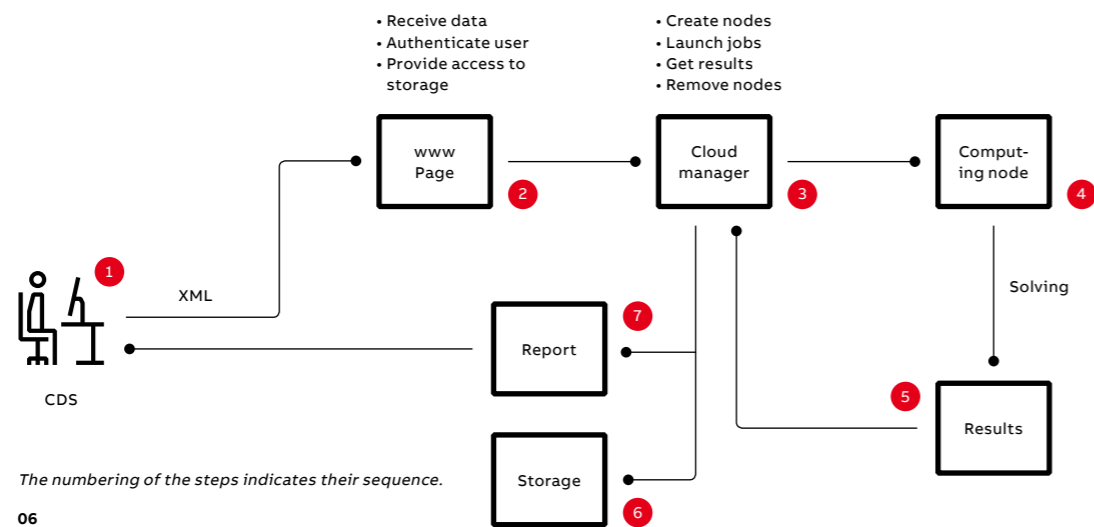

06

06 OpenFOAM makes it possible to scale simulations across computational cores and leverage high performance computing at an ultra-low cost.

The overarching idea of the project was to

- provide a simple and reliable tool for fluid flow – thermal simulations of dry transformers,
- use open source technologies to keep operational expenses at a minimum,
- use cloud computing (Microsoft Azure) to reduce computational overheads and
- make it easy enough for use by every engineer in dry transformer factories regardless of their theoretical background in thermal-fluids.

DryFOAM starts with a single design input file, which is also used universally by ABB's Common Design System (CDS) for transformer design. It automatically extracts geometrical parameters, such as winding, core and enclosure dimensions, loads (losses) and boundary conditions (environmental temperature). Octave (another open source system, analogous to Matlab commercial software) scripts then takes over to build a 2D axisymmetric representative model of a transformer including core, windings, cooling ducts, enclosure, ventilation openings and air domain around the device. Finite volume meshes are generated according to CFD method needs, ensuring quality of elements and boundary layer details for resolving near wall flow for natural and forced convection. Finally, DryFOAM's workflow assigns heat sources, material properties, boundary conditions and solver settings. When the model is ready DryFOAM starts calculations and generates a report after the solver reaches a stable solution. One of DryFOAM's key features is automated report generation. This facilitates communication of results in the most readable format for designers. Simulation complexity is abstracted in the process and designers are shown key information regarding core-coil thermal performance. Designers know not

only the average winding temperatures, but also hot spot temperatures and locations. A report can then be downloaded or stored in the system.

From a deployment perspective, DryFOAM is fully containerized. It can therefore be used on a laptop, workstation or in the cloud. Cloud solutions appear to be particularly promising because a predefined DryFOAM Cloud User Interface ensures data security and enables fast and easy file input and

One of DryFOAM's key features is automated report generation. This facilitates communication of results in the most readable format for designers.

uploads as well as report downloads and online/live presentation of solution stability parameters versus iteration. At its current stage, DryFOAM software enables 2D calculations of two construction types, but plans call for more detailed 3D calculations that enable other types of transformers such as Resibloc and traction transformers. Even more importantly, the tool's skeleton can be easily adapted to the simulation of other ABB products. •

DIGITAL TWIN AND SIMULATIONS

Advancing product design and manufacturing with 3D printing

ABB applied advances in numerical software to additive manufacturing technology to create powerful solutions for the 3D printing process that optimize and improve the design of essential components, while reducing overall costs.

01 The use of light-weight high performance industrial paint robots can result in lower operational costs. A light-weight paint manifold located at the tip of the robot arm is essential.



Lukasz Matysiak
Tomasz Nowak
Robert Sekula
Dariusz Bednarowski
ABB Corporate Research
Krakow, Poland

lukasz.matysiak@pl.abb.com
tomasz.nowak@pl.abb.com
robert.sekula@pl.abb.com
dariusz.bednarowski@pl.abb.com

Frederic Tholence
Erik X. Johansson
ABB Corporate Research
Västerås, Sweden

frederic.tholence@se.abb.com
erik.x.johansson@se.abb.com

Peter Schuster
ABB Technology Center
Uster, Switzerland

peter.schuster@ch.abb.com

01

During the last decade, rapid progress has been made in Additive Manufacturing technology (AM), also known as 3D printing: the manufacture of parts by adding material in a layer-by-layer process [1]. Scores of AM processes fabricate metallic or polymeric parts; utilize different combinations of stock material forms, deliver varied materials and

employ various heat sources. The family of material extrusion processes (Fused Deposition Modelling or Fused Filament Fabrication) is an important example. Relying on the original filament form, objects are built by the selective deposition of a melted thermoplastic polymer. This contrasts with powder-based processes (using metallic or

polymeric powder) in which powder is spread onto the apparatus base before it is scanned or fed directly to the heat affected region.

Thanks to these advances, AM provides manufacturers with freedom in design and the ability to build (3D print) an assembly composed of multiply integrated parts.

ABB evaluated engineering tools and simulations to determine specific instances where AM applications offer customers value beyond design freedom.

Nevertheless, the inherently complex processes pose obstacles that can impede the broader application of AM. For instance, product geometry and material structures, which are defined during the AM process, pose complex constraints. Additionally, the process itself can influence the material deposited during this manufacturing technique in which a single layer is “cast” upon a previous layer. The combined effects of rapid

solidification, directional cooling, and phase transformations induced by repeated thermal cycles can adversely impact the microstructures of the material deposited. Moreover, the produced parts may not comply with the mechanical requirements due to unacceptable porosity levels. The thermo-mechanical nature of the process can result in serious dimensional inaccuracies: the result of thermally induced residual stresses and distortions [2].

Not surprisingly, numerical engineering tools, eg, finite element analysis software packages, reveal physical phenomena that are critical. In this way, engineers can understand the link between the product design, process settings, material microstructure and physical properties of the 3D-printed products. Numerical tools are also very effective in parametric and topology optimization methods, where the aims are to reduce the weight of the component and to optimize the printing time.

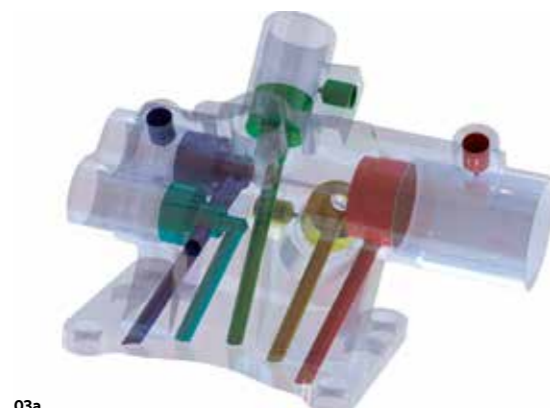
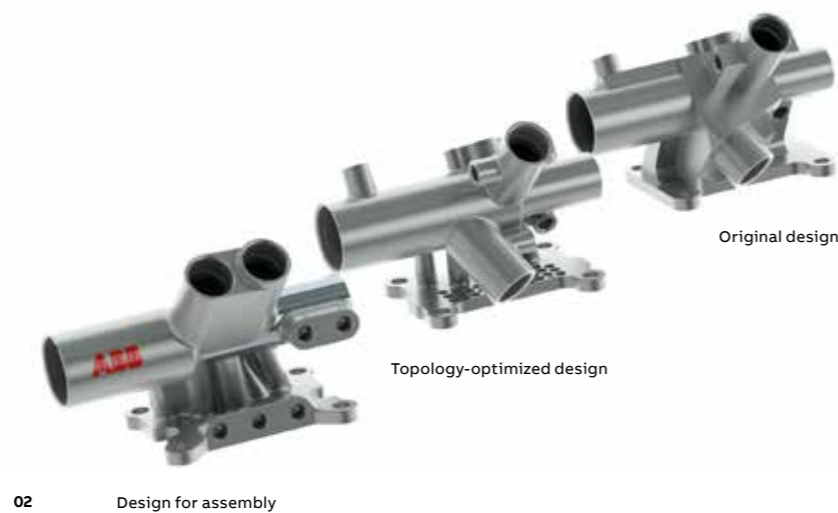

03a



03b

—
02 Evolution of the design phases of a lightweight paint manifold is shown. All air pilot inlets are located on the same side (left).

—
03 Comparison of the inner channels

03a original design

03b the design for assembly components.

—
04 Various design concepts were proposed by optimization algorithms.

04a The results of various design concepts is shown.

04b Simulation of the mold filling process.

04c The resultant cast demonstrator of a lower arm of an industrial robot.

ABB case studies

ABB evaluated engineering tools and numerical simulations in three case studies to determine specific instances where AM applications offer customers value beyond the advantage of design freedom. Toward this end, the perceived drawbacks of AM – long printing times and high costs – were addressed:

- Metal 3D printing of the complex paint manifold
- Topology optimization and so-called hybrid manufacturing of a robot arm demonstrator
- AM-based tooling for injection molding

The paint manifold case study – metal 3D printing

For industrial robotics, eg, paint robots →1, lightweight structures would positively impact robot cycle time, accuracy, payload and energy consumption by reducing time and cost. In particular, the paint atomizer module located at the end of a paint robot arm would benefit from weight reduction →1. Furthermore, AM techniques might yield additional advantages: ease of assembly, easier cleaning and improved component robustness.

The function of the paint manifold is to mix two components of a paint (resin and catalyst) right before atomization →1. Traditionally manufactured from a stainless-steel block using conventional CNC machining, the inner side of the manifold consists of a complex of network pipes – making the production of the manifold costly, increasing material waste and delivery time. Consequently, roughly 88 percent of the initial stainless steel block is machined away.

Any addition of unnecessary material to an AM component will increase the weight and add to the cost of the final part, so printing lightweight structures is crucial. Weight optimization is accomplished usually through topology optimization (TO). Initially, service loads are applied to the component. The optimization engine derives the density of each element that is required to maintain the structural stiffness of the component. The resulting density map of the component can then be used to produce a typical bionic structure or a lightweight lattice structure.

ABB successfully demonstrated that AM is especially well-suited to manufacture these types of complex shapes. The lightest version of the manifold exhibits both bionic and honeycomb features →2. Total weight was reduced by a phenomenal 43 percent while functionality and structural stiffness were preserved.

Next, the manifold was redesigned to improve the printing process and ease the post-CNC machining step. A dedicated computer software was employed to optimize the orientation of the



04a

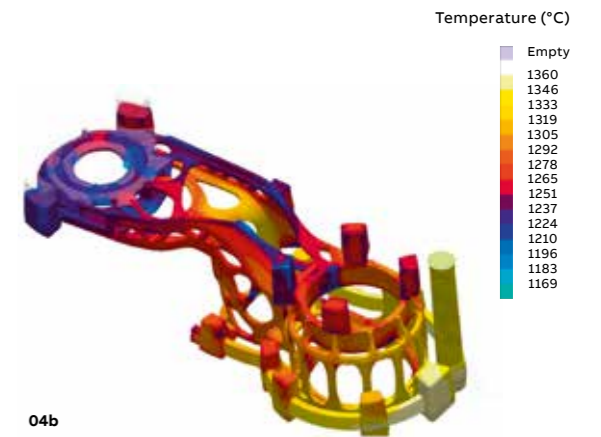

04b



04c

component during the printing process. Volume of support (eg, waste material), printing time, deformation, amount and ease of post-processing and number of parts that fit on a building plate were all evaluated with the aim of improving part quality and cost.

Any addition of unnecessary material to an AM component will increase the weight and add to the cost of the final part, so printing lightweight structures is crucial.

Printing time was reduced by 10 percent while the volume of support required was reduced by an extraordinary factor of six.

Later, the design of the manifold was modified to ease the assembly →2. In contrast to traditional manufacturing techniques, which can limit the



05

shape of inner channels to straight holes, AM offers the possibility to produce curved channels that extend freely inside the structure. The path of the air channels could then be redrawn freely inside the manifold so that all of the air pilot valves could be placed on the same side of the component →3. The result is ease of assembly and a more rational post-CNC machining.

ABB employed the SLM technique to produce prototypes of this new generation of manifold; this resulted in a significant weight reduction, ease of assembly and reduced the amount of material waste. Component delivery time was shortened from three months to only three weeks.

Altogether, this improved manifold provides ABB's customers with a better design and makes enhanced robot performance highly accessible.

Topology optimization of a robot arm

The main advantages of AM technology (design freedom, easy manufacturing of complex parts, printing-on-demand) are impaired during the 3D printing of robot components (eg, aluminum arms in which there are limited number of materials available, small size of components, high production cost and long printing time). In contrast, classical methods, eg, casting, are highly efficient and applicable to a virtually unlimited

size range of components. For this reason, ABB evaluated a hybrid strategy of production. First, the lower arm of an industrial robot was optimized topologically [3,4], in order to discern various design alternatives →4a,4b.

Thereafter, the sand mold was produced by 3D printing and then treated as a tool in the subsequent manufacturing process: classical casting. ABB developed a completely new concept of the robot's lower arm, one that pushes beyond the previous limitations of AM technology.

The demonstrator →4c resulted from a unique mixture of three different technologies: the generative design, which helps engineers to propose concepts of free-form shapes; the additive manufacturing, which produces the pattern (the tool) instead of the part itself; and metal casting, which materializes the designer's idea using a 3D-printed mold and the strong yet lightweight metal alloy.

In this way, ABB demonstrated that it can be more profitable to produce a tool using AM technology, and then employ this tool to advantage during standard manufacturing processes.

AM-based tooling for injection molding

AM technology has resulted in higher resolution 3D printers that are faster and more accurate than ever before, and in the development of new materials for use in the injection processes. Consequently, several AM vendors proposed the direct 3D printing of injection mold cavities [5,6], without the need of subsequent cavity machining ie, ready to be adopted on a metal mold frame →5.

ABB showed that it can be more profitable to produce a tool using AM technology and then employ this tool during standard manufacturing processes.

The 3D-printed polymeric injection cavities are priced lower than metal tooling (usually 50 to 70 percent less) with a much shorter lead time (days). Unfortunately, 3D-printed polymeric molds are best suited for jobs up to 100 shots (depending on the material type and mold complexity) due to current technological limitations. Other constraints include: the range of thermoplastics that can be processed, high cost of raw material for 3D printing and long injection molding cycle time (15 to 20 times longer than for metal cavities) due to the low thermal conductivity of polymers used for 3D printing. ABB proposed a completely new approach to

—
05 3D-printed polymeric mold is shown, which is ready for injection molding process.

—
06 Simplified 2D geometry that is analyzed during thermal simulations. The computational model utilizes symmetry.

—
07 Comparison of cycle times obtained for different mold design concepts.

References

[1] Wohlers Report 2016, "3D Printing and Additive Manufacturing State of the Industry," Wohlers Associates Inc. USA, 2016.

[2] B. Stucker, "Physics-Based Simulation: Accelerating Innovation in Additive Manufacturing," 12th Intl. Conf. Additive Manufacturing and 3D Printing, Nottingham, UK, 2017.

[3] Y. Saadlaoui, J. Milan, J. Rossi, P. Chabrand, "Topology optimization and additive manufacturing: Comparison of conception methods using industrial codes." J. Manufacturing Syst., vol. 43, Part 1, April 2017, pp. 178–186.

[4] M.K. Thompson, G. Moroni et.al., "Design for Additive Manufacturing: Trends, opportunities, considerations, and constraints." Manufacturing Tech., vol. 65, Issue 2, 2016, pp. 737–760.

[5] R.A. Harris, H.A. Newlyn and P.M. Dickens, "Selection of mould design variables in direct stereolithography injection mould tooling." Proc. Instit. Mech. Eng., Part B, J. Eng. Manufacture, vol 216 No. B4, 2002, pp. 499–505.

[6] G.V. Salmoria, F.V. Lafratta, M.M. Biava and P.Z. Ferreira, "Rapid manufacturing and rapid tooling of polymer miniaturized parts using Stereolithography". J. Brazilian Soc. Mech. Sci. and Eng., vol. 30, No. 1, 2008, pp. 7–10.

overcome these aforementioned limitations. 3D printing is used to produce a shell structure only, which is then filled with material of a higher thermal conductivity. The thickness of the 3D-printed shell structure is the fundamental consideration during the design stage when the contradiction of requirements must be considered: a small thickness is associated with a short cycle time whereas a large thickness ensures good mechanical stability. The impact of the shell thickness on cycle time (cooling efficiency) was assessed using Ansys/Fluent on the geometry →6. The thickness of the shell wall (from 1 mm to 5 mm) and the solid structure (polymer and steel) were studied. Selected computational results of cavity surface temperatures for analyzed scenarios during the first and stable cycles →7 show the extreme impact of shell thickness on cooling efficiency, even during the first cycle. The cycle time following attainment of stable processing conditions, for solid polymer cavities is circa 15 times longer than for steel cavities. This essential final consideration and optimized design allows the cooling time to be reduced by a factor of four to seven; this translates to a cycle time that is only two to three times longer than for steel molds – an excellent result.

Outlook

AM and all its technological benefits are changing the way products can be designed and produced. AM is already mature enough to compete with

traditional subtractive manufacturing processes or production technologies like injection molding in terms of material properties, dimensions of geometries, material and process costs. Companies developing simulation software, AM machines and materials providers are expected to continue their efforts to offer customers ever more user-friendly and automated solutions. Customers will benefit from greater freedom and flexibility in terms of geometry; this results in lightweight structures and excellent mechanical performance in functional integration and in parts consolidation.

AM and its technological benefits are changing the way products can be designed and produced – competing with traditional subtractive manufacturing processes.

Currently, ABB is investigating another trend, namely multi-physical numerical simulations of the printing process itself; this includes thermo-mechanical interactions between single particles and layers of the printed object (of metallic and polymeric powders). ABB will present these simulation results once the tests and intensive verification procedures are completed. •

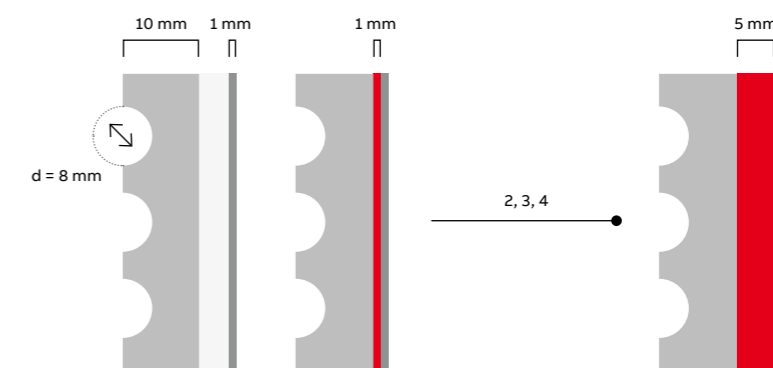

06

Case study	1st cycle (s)	Stable cycle (s)
Steel mold	10	11.5
Fully 3D-printed model & 5 mm shell	44	171
2 mm polymer shell filled with material with higher thermal conductivity	33	40

07

DIGITAL TWINS AND SIMULATIONS

Digital avatars for powertrains expand digital twin concept

A digital twin is an almost identical copy of a physical device. However, to really benefit from digital opportunities, a digital representation with more capabilities than the physical object is desirable. This “digital avatar” interacts with the digital world in ways its physical counterpart cannot.

—
Piotr Lipnicki
Daniel Lewandowski
 ABB Corporate Research
 Kraków, Poland

piotr.lipnicki@pl.abb.com
 daniel.lewandowski@pl.abb.com

—
Diego Pareschi
 ABB BV
 Rotterdam, Netherlands

diego.pareschi@nl.abb.com

—
Enrico Ragaini
Gabriele Perrone
 ABB S.p.A.
 Bergamo, Italy

enrico.ragaini@it.abb.com
 gabriele.perrone@it.abb.com

Modern industry strives to meet many challenges, such as operational excellence, better efficiency and improved profitability. In short, what is called for is to produce more with less, with a larger profit and to do it in an environmentally friendly way.

One way to meet these goals is to exploit the power of digitalization. From a practical point of view, this could mean creating appropriate “digital twins.” A digital twin can be characterized as the mixture of data and intelligence that represents the arrangement, context and nature of a physical system of any kind, including an interface that gives one understanding of the past and present operation, and allows for predictions. However, the digital twin concept

—
 To fully benefit from digital opportunities, a digital representation that has capabilities additional to those of the physical object is required – this is the digital avatar.

is limited. The challenge lies in representing the physical version of an entity much more authentically in the digital world. There is much more information available than just that relating directly to the device, system, plant or model. For example, user interaction produces and uses

many kinds of digital information: Real-time measurements, models, 3D graphics, user manuals, operator notes and service instructions are all aspects of the object that may also be important. To fully benefit from digital opportunities, a digital representation that has capabilities additional to those of the physical object is required – this is the digital avatar. The digital avatar is a digital object, native to the digital world, that represents the physical object but that can interact in the digital world in ways its physical counterpart cannot →1.

The data comprising a digital avatar can be grouped and classed as a particular system – eg, a digital powertrain.

Digital powertrain

A digital powertrain is a suite of solutions for the digitalization of, for example, the compressors that are so critical to the oil, gas and chemical industries. The digital powertrain concept encompasses devices, software and services. Digital powertrain solutions exploit the advantages of connectivity and data analytics melded with domain expertise. Each physical powertrain, including all its components such as drives, motors, bearings and target applications like pumps and compressors, can send data to the cloud that is then visible to the operator on a simple dashboard. In a further stage, condition monitoring and predictive maintenance services can be employed to make support or repair recommendations based on actual, ongoing levels of stress and wear.



01

—
 01 Compressors are critical items in oil, gas and chemical processes. By elaborating on the digital twin concept to create a “digital avatar” of the compressor powertrain, a rich digital counterpart can be created that better reflects the experiences of compressors in the real world.

ORKAN

To remain at the forefront of digital and technological innovation, ABB develops intelligent concepts that are verified by means of design review, advanced model simulations and rigorous experiments conducted under strictly controlled conditions, especially in relatively small-scale setups. The ORKAN compressor control and diagnostic test stand is one such setup →2.

—
 The digital powertrain concept encompasses devices, software and services.

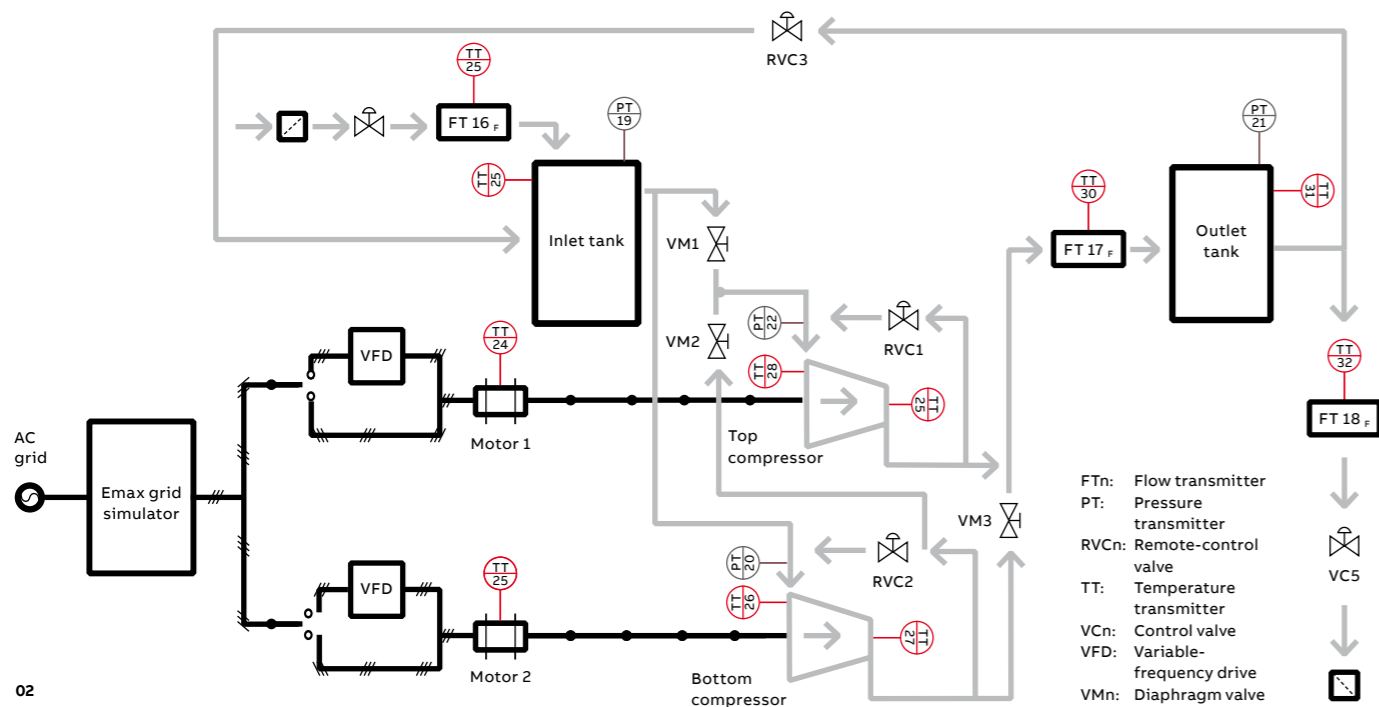

02

The ORKAN compressor test rig allows evaluation of all different kinds of concepts connected with digital powertrains →3.

The ORKAN stand is used, for instance, to gauge the influence of electrical faults on process-side stability and develop solutions to protect against these disturbances. In recent years, the test rig has been successfully employed to develop and test solutions that cope with grid disturbances, and electrical and mechanical issues. Process control modes – such as basic process control, suction pressure control, discharge pressure control and anti-surge control – can also be explored on the test rig and robust solutions for operational eventualities developed.

The test stand is equipped with ABB devices such as ACS880 and ACS850 low-voltage drives, two induction motors, an AC800 PEC controller, AC500 high-performance and AC500 CMS (condition monitoring system) PLCs (programmable logic controllers), an Emax Sace breaker (with additional Raspberry Pi logger), and a variety of flow, pressure and temperature sensors. The inclusion of an ABB ServicePort application allows all users to view, scan and track all key performance indicators (KPIs) to enable maximum performance of the compressors and the processes involved →4.

Case study

The ORKAN test stand has the basic elements of the digital twin – and additional facets that comprise the digital avatar: document management, modeling, simulation, 3D representation, data model, visualization, model synchronization and analytics.

The ORKAN stand is used, for instance, to gauge the influence of electrical faults on process-side stability and develop solutions to protect against these disturbances.

Document management

Software is tracked by Git (an open-source version control system). A full set of stand operating instructions is maintained and service records are available in the form of data logs, event logs and reports.

Modeling

Modeling is based on analytical process models, and electrical and mechanical dynamic models,

— 02 ORKAN stand piping and instrumentation diagram.

— 03 ORKAN stand.

of the compression system. Simulation and measurement campaigns were used to verify the accuracy of the modeling. Optimization is focused on process control and uses MPC (model predictive control) antisurge control for compression systems – including T2S (time to surge) functionality. The diagnostics part is based on algorithms and analytics that handle both the rotating machinery and the process.

Modeling focuses on condition monitoring as well as on energy and process management.

Simulations

The simulation part consists of two major elements: design simulation and compressor system throughput simulation. The former uses detailed

simulation models that cater for set-point change, disturbances, fault modes and noise. The latter makes it possible to simulate and evaluate throughput optimization for compression systems (load sharing, series operation, antisurge operation, etc.) during normal operation or during various faults. Simulations are then verified by experiment.

3D representation

The 3D representation is based on design drawings of ABB and third-party components.

Data model

The data model uses engineering data relating to sensors, measurement and control equipment, and other devices all the way up to the gateway and the cloud. The data model is designed to fulfill different tasks: control, processing, diagnostics and condition monitoring, and analytics. The production data used consists of details on produced gas characteristics (flow, pressure, etc.) Operational data input covers availability, performance, quality, overall equipment efficiency (OEE), etc. The service data used is obtained from various sources – ServicePort, Java Apps, Emax, the AC500 CMS, the ABB low-voltage distributor, etc. →5,6.



03

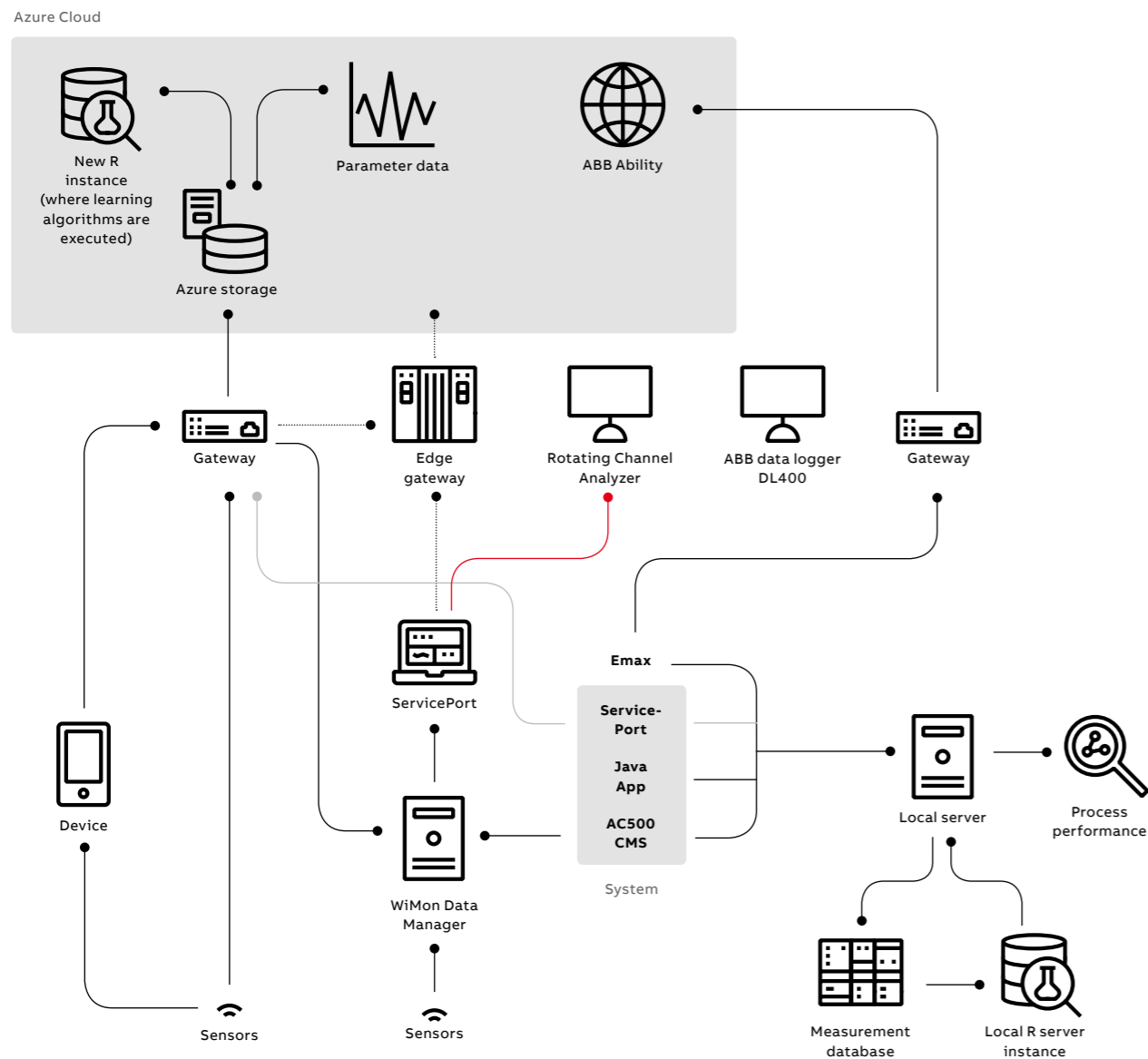

04

Visualization

The digital visualization is presented as plots, characteristics and time-series data generated by the simulations.

This cloud architecture has been developed together with Microsoft to enhance performance and guarantee the highest reliability and security.

The operation state display comes from the real-time data stream (from the operation station) and has a similar form. The health status is displayed as alarms and notifications (on the local app, gateway or cloud).

Model synchronization

The synchronization of digital simulation data with the real measurements is based on real-time evaluation in terms of control, process, diagnostics and monitoring.

Analytics

Analytics focus on algorithm verification based on models, simulations and measurements. The analytics generate a suite of KPIs: operational KPIs are based on the process, electrical, mechanical and control data; asset health KPIs use detailed service/diagnostic KPIs – process, electrical, mechanical and control – implemented in the new ServicePort Rotating Equipment Analyzer channel.

All the points above can be included in a cloud platform connected to ORKAN – eg, Electrical Distribution Control System, which is a cloud computing platform designed to monitor, optimize and control electrical systems. Part of the ABB

Ability™ offering, Electrical Distribution Control System is built on a state-of-the-art cloud architecture for data collection, processing and storage. This cloud architecture has been developed together with Microsoft in order to enhance performance and guarantee the highest reliability and security.

The digital avatar opens up new fields

Digital twins are limited in that they are “merely” a digital representation of an object and its real-time performance. In contrast, the digital avatar, as described using the ORKAN stand example, is a bigger concept. Digital avatars should be able to interact as digital twins do, but also in enhanced ways and with a much wider set of digital partners and circumstances. In principle, the idea is to make as much information and as many entities as possible available to the digital avatar’s analytic algorithms.

The digital avatar concept opens up many fields for additional actionable insights, analyses and informed decision making.

The ORKAN stand has been used to illustrate the digital powertrain of an oil and gas compressor. However, this unique testing environment utilizes so many ABB products and technologies that it can be treated as a general ABB digitalization testing facility.

The digital avatar concept opens up many fields for additional actionable insights, analyses and informed decision making and shows the way forward so that modern industry can achieve the ever more demanding goals that are set before it.

04 ORKAN compressor control and diagnostic test stand – functional overview.

05 ABB Ability Electrical Distribution Control System platform view 1.

06 ABB Ability Electrical Distribution Control System platform view 2.

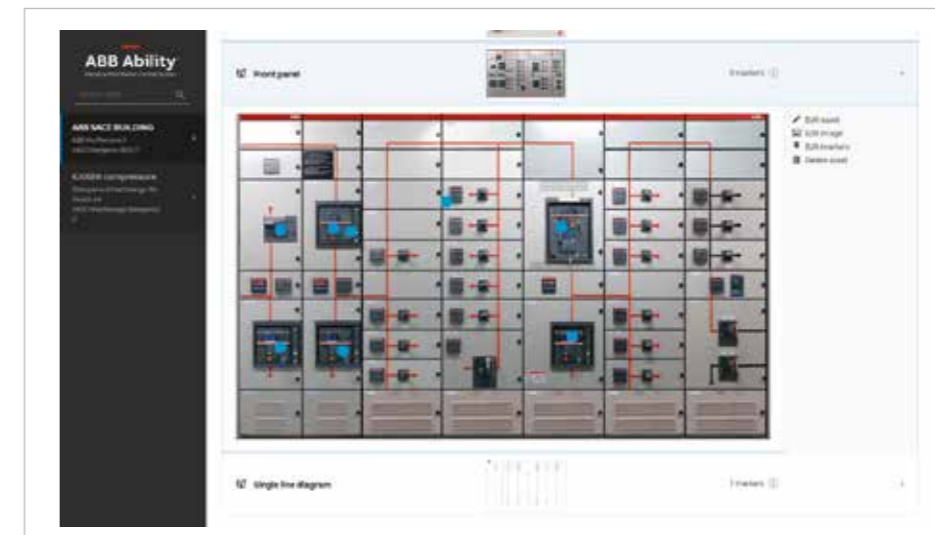

05

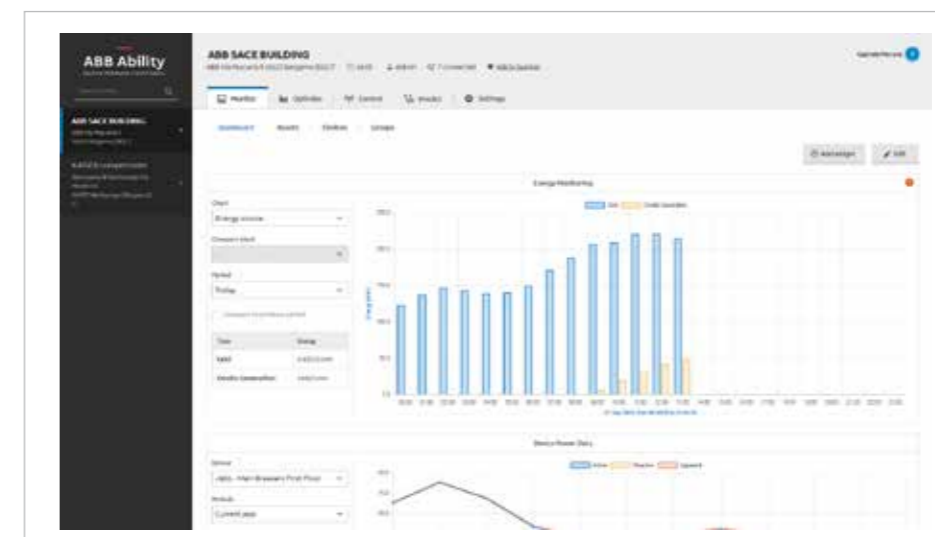

06

DIGITAL TWINS AND SIMULATIONS

Transforming condition monitoring of rotating machines

Usually, only the most critical rotating machines in a plant are continuously monitored for maintenance purposes. In a pilot plant, ABB has now equipped less-critical equipment with a solution based on inexpensive sensors, machine learning and software that allows cost-effective but advanced monitoring.



01 Extending condition monitoring and predictive maintenance capabilities on rotating machines to less-critical equipment in a cost-effective way allows customers to run their plants more efficiently.

02 Condition monitoring architecture for non-critical rotating equipment. Note that some aspects of this architecture could vary between plants (eg, not all use a Wireless HART or Bluetooth connections).

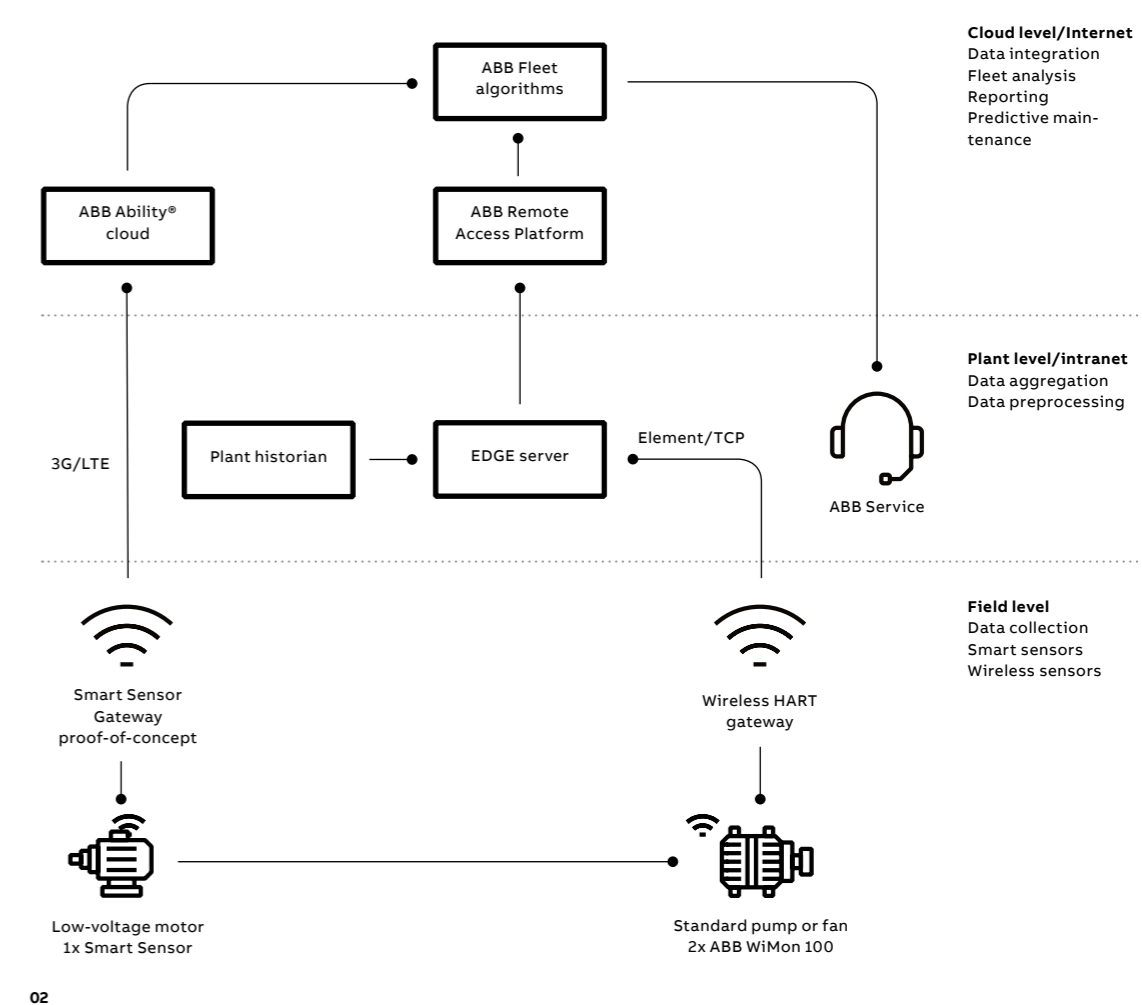

Ralf Gitzel
Benedikt Schmidt
Arzam Kotriwala
Ido Amihai
Guruprasad Sosale
 ABB Corporate Research
 Ladenburg, Germany

ralf.gitzel@de.abb.com
 benedikt.schmidt@de.abb.com
 arzam.kotriwala@de.abb.com
 ido.amihai@de.abb.com
 guruprasad.sosale@de.abb.com

James Ottewill
 ABB Corporate Research
 Krakow, Poland

james.ottewill@pl.abb.com

Marco Heese
 ABB Automation GmbH
 Mannheim, Germany

marco.heese@de.abb.com

Diego Pareschi
 ABB B.V.
 Rijswijk, Netherlands

diego.pareschi@nl.abb.com

Subanatarajan Subbiah
 Former ABB employee

In a typical industrial plant, condition monitoring and predictive maintenance are usually only applied to the most critical rotating equipment. For cost reasons, less-critical items are often only analyzed on a best-effort basis.

Early intervention, which reduces the need for corrective maintenance, is more cost-effective than simply allowing a component to run to failure.

To investigate how to monitor, diagnose and predict failures on less-critical – but widely utilized – rotating equipment, such as motors or pumps, ABB conducted a 30-month study in which a pilot installation at a customer site was equipped with cost-effective sensor technologies, machine learning and a software solution driven by key

condition indicators (KICs) →1. Vibration data was taken multiple times a day from 30 pumps. A network of IoT (Internet of Things) devices collected relevant data from which analytics extract insights.

Background and motivation

Condition monitoring of industrial assets, such as motors or pumps, can ensure that critical issues are detected early, thus avoiding unplanned downtime or damage. Early intervention, which reduces the need for corrective maintenance, is more cost-effective than simply allowing a component to run to failure. However, the high costs associated with condition monitoring systems mean that their deployment is currently limited predominantly to critical assets.

A process industry plant – for example, a chemical or pharmaceutical factory – typically contains a large fleet of non-critical motors that drive pumps. While the cost of failure here is considerably lower than that for critical equipment, these assets would benefit from a cost-effective early failure detection

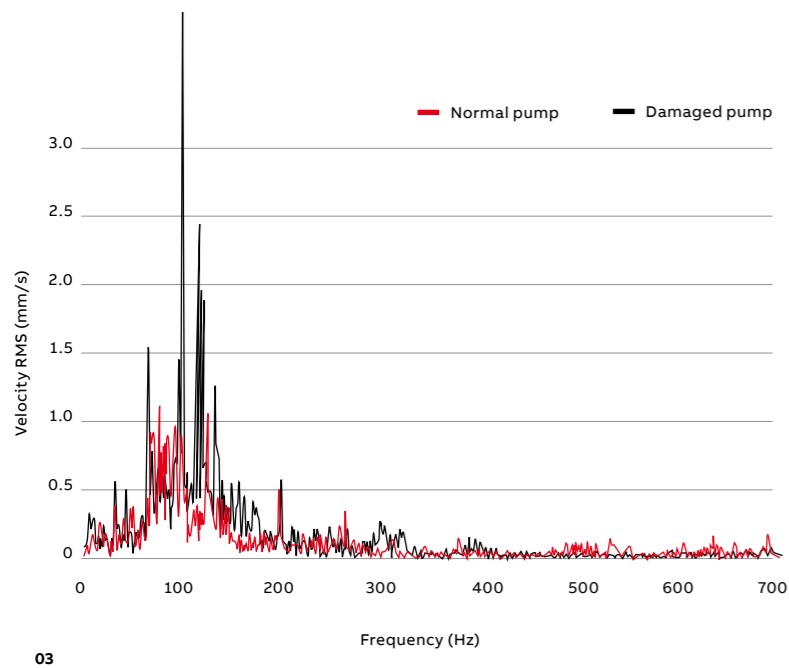

03

system. Not only would early failure detection help avoid further damage, but a pre-diagnosis of problems could also reduce the time needed to repair the asset.

Overall solution architecture

The condition monitoring architecture for the non-critical rotating equipment in the pilot study has three levels →2:

- Field level, with sensors attached to assets to collect data.
- Plant level, which covers plant-wide sensor data aggregation and preprocessing.
- Data integration platform level (eg, cloud or other platform), for fleet data analytics such as benchmarking, predictive maintenance) and reporting.

Architecture level 1: field

The field level specifies the sensor-based data collection process up to the transmission of the collected data. The assets considered are the standard pieces of rotating equipment in a commercial process plant – for example, low-voltage motors and pumps. Each item covered by the study was fitted with a commercial wireless condition monitoring system, ABB WiMon 100, which was used to capture vibration data. The WiMon system consists of a vibration sensor (accelerometer) to capture the vibrations and a temperature sensor to capture the surface temperature of the rotating equipment. WiMon systems use a mesh network technology which simplifies the data transfer in the plant. Additionally, low-voltage motors were fitted with an ABB Ability™ Smart Sensor, which converts traditional motors into smart, wirelessly connected devices.

The data collection scheme in the WiMon system can be configured according to the requirements of the user. Typically, every hour, an aggregated value of the root-mean square of the velocity in mm/s and the actual surface temperature in °C is stored as time-series data. To perform detailed vibration analysis, every six hours the raw signal from the accelerometer is captured for a sample time of 700ms and an FFT (fast Fourier transform) of the captured raw signal is computed. The resulting frequency spectrum allows components of the vibration signal at selected frequencies to be extracted and analyzed further.

Architecture level 2: plant

The mesh network established by the WiMon systems is connected to a wireless HART gateway. Through the gateway, the sensor data collection is connected to the plant network, making it available for different analyses on a plant-wide level. In the realized architecture, the collected asset signal data is stored in the plant historian and processed in the ABB edge server installed at the plant.

Architecture level 3: data integration platform

ABB's Remote Access Platform allows for the transfer of the asset signal data to the data integration platform. In addition to its remarkable computation capabilities, a major benefit of this platform is the possibility to collect data from many plants.

With many plants connected, fleet data analytics can be performed on the platform to compare and benchmark different locations and regions.

With many plants connected, fleet data analytics can be performed on the platform to compare and benchmark different locations and regions. A condition monitoring algorithm is used to process all collected data and allow remote access to the analytics results from different locations.

Diagnostics: analytics behind key condition indices

The usefulness of a condition monitoring system depends on its ability to provide concise, meaningful and actionable information to its user. Vibration data can be used to calculate a series of metrics that are useful for a maintenance manager to identify actions required to avoid further asset deterioration. For example, an imbalance in the rotating equipment

—
03 Example frequency spectrum of a normal pump and a damaged pump.

—
04 Overview of the predictive modeling approach.

manifests itself as an increased vibration at the rotating frequency. In the scenario discussed here, frequency spectrum data are fed to proprietary algorithms developed at ABB to calculate KCIs for failure modes (eg, bearing fault or cavitation) a piece of rotating equipment might experience →3.

A KCI is a numerical value that indicates the severity level of the corresponding failure mode observed in the equipment. The following example KCIs monitor problems that can be detected using vibration data:

- Blade problems: When monitoring pumps, certain peaks in the frequency spectrum indicate damage to the blades in the pump. The blade problem KCI reflects how pronounced these critical peaks are.
- Flow turbulences: This KCI indicates irregularities in the flow of liquid passing a pump. Turbulences can be problems in themselves or indicators thereof.
- Looseness: The central shaft in rotating equipment is often constrained by the bearings so that its rotational axis does not fluctuate. Excessive clearance, typically caused by wear in the bearing, will mean that the shaft will exhibit vertical and horizontal movement, which can quickly lead to further damage. The Looseness KCI indicates whether and to what degree the equipment suffers from this problem.
- Misalignment: All components of rotating equipment must be well aligned. However, damage during transportation or irregularities during operation can cause deviations from the ideal alignment position. Like Looseness, misalignment can cause further damage to the asset as well as reduce its performance.
- Imbalance: Ideally, the rotating elements in a piece of equipment are balanced. This means that the mass is distributed equally in all directions. An example of imbalance would be a piece of matter sticking to one of the blades in a pump, which will exert additional force on the bearings.
- Cavitation: Cavitation is a well-known pump-related problem. Small low-pressure bubbles can occur when force is exerted on a liquid in such a way that there are rapid pressure changes. Due to the higher pressure around them, these bubbles can implode and cause damage to the pump. The Cavitation KCI detects the occurrence of cavitation-related implosions.

Predictive maintenance: using machine learning to predict asset health

A neural-network-based, machine-learning model was trained to predict the future health status of the assets. The prediction, or prognosis, is based on KCIs and other asset information and their

The usefulness of a condition monitoring system depends on its ability to provide concise, meaningful and actionable information to its user.

changes over time. For example, based on the past KCI values C_{t-n}, \dots, C_{t-1} , the neural network predicts future values C_{t+1} and C_{t+n} , where n indicates the prediction or “look-ahead” window. If the predicted value of an asset crosses a threshold, a message is provided to the asset manager stating that it ought to be inspected →4.

The threshold used to determine poor asset health can be determined using either industry standards or in a data-driven manner, where a large sample of KCI values would be provided to a different machine-learning model that can categorize the data into separate classes based

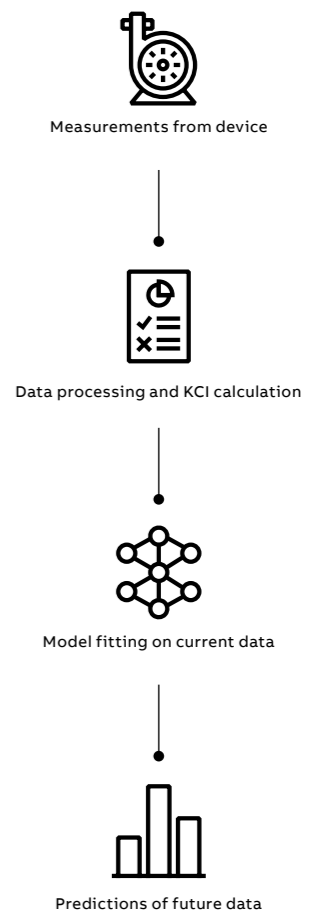

04

Predictions of future data



05



06

ABB’s machine-learning approach proved highly effective at predicting deterioration in asset health, which was detected approximately 90 percent of the time on these asset types.

on these values. Regardless of the threshold, ABB’s machine-learning approach proved highly effective at predicting deterioration in asset health, which was detected approximately 90 percent of the time on these asset types (the exact values depended on the KCI used, as well as additional factors like the size of the look-ahead window).

Application scenarios

With the architecture described earlier and with the analytics developed for diagnostics and prognostics as the basis, a prototype solution

to serve the asset managers and personnel responsible for maintenance was built →5,6.

The diagnostic results are presented to the end-user as the current status of the asset, which can be either “Keep running,” “Wait and watch” or “Needs attention.” The predicted status can be either “Keep running” or “Needs attention.”

Below, the potential scenarios that can occur and how the technology developed helps the end-user to benefit from it is explained →7.

Scenario 1

Starting with the trivial scenario in which the asset is operating normally with no damage predicted, the current and predicted statuses are “Keep running.” No unnecessary time-based maintenance need be undertaken.

Scenario 2

In this scenario, consider the case where the asset is currently exhibiting evidence of damage but not imminent failure. Thus, the current-status field advises the user to keep operating the asset and

05 Dashboard displaying the overview of the fleet of assets with the condition monitoring system.

06 Dashboard with selected asset status and failure mode overview.

07 Potential scenarios, corresponding actions and benefits to the customer.

the predicted-status fields for the weeks ahead would show “Needs attention” and recommend an action. The action proposed to the user is to explore the asset sensor data in a detailed fashion and to take appropriate action. The diagnostic algorithms indicate any damage – for example, a misalignment detected in the detailed view would lead to a recommendation to perform an alignment process rather than unmount the asset, which focusses effort on required maintenance only.

Scenario 3

Here, the case is considered where the asset is currently exhibiting evidence of significant damage, not severe enough that it needs to be stopped, but enough that its condition should be monitored closely. The predicted-status fields for the upcoming two weeks would show “Needs attention” as a recommendation. The action proposed to the user is to explore the asset sensor data in a detailed fashion and take appropriate action based on different failure modes. The diagnostic algorithms indicate any initiated damage. For example, blade problems being detected in the detailed view would result in a recommendation to perform a maintenance process that might require unmounting the asset. This would help the asset manager to plan spare parts and coordinate maintenance effort to minimize downtime.

Scenario 4

In this scenario, the asset is currently exhibiting symptoms of considerable damage and could reach a significant damage level in two weeks or later. However, since there is no devastating damage in the current status, it advises the user to “Keep running” and the prediction based on past historical data and current data would suggest the status field for the two-week prediction as “Needs attention.” The proposed action is to perform

a more detailed analysis of the sensor data as a fingerprint report. This would help the asset manager to take an informed decision on planning any maintenance required, if any.

Insights and foresight

Several important insights emerged from the development of this prototype predictive maintenance solution:

- Data preparation is an important, often under-considered, aspect.
- Where new data is periodically collected from the field, special consideration has to be given to data consistency to account for cases, for instance, where a sensor has been moved or replaced.
- There are unique challenges associated with managing and manipulating live data.

By addressing these challenges, and by combining domain knowledge with machine-learning approaches, ABB was able to deliver a reliable and robust condition monitoring solution for non-critical rotating equipment. Results achieved when applying the approach to a real customer case showed that the KCIs could be predicted accurately up to two weeks ahead. •

Scenario 1	Scenario 2	Scenario 3	Scenario 4
Current status: Keep running	Current status: Keep running	Current status: Wait and watch	Current status: Keep running
1-week prediction: Keep running	1-week prediction: Needs attention	1-week prediction: Needs attention	1-week prediction: Keep running
2-week prediction: Keep running	2-week prediction: Needs attention	2-week prediction: Needs attention	2-week prediction: Needs attention
Blade problems: -	Blade problems: -	Blade problems: Detected	Blade problems: -
Misalignment: -	Misalignment: Detected	Misalignment: -	Misalignment: -
Imbalance: -	Imbalance: -	Imbalance: -	Imbalance: -
Proposed action Do not do preventive maintenance at indicated asset	Proposed action Look at asset view and failure-mode KPIs	Proposed action Look at asset view and failure-mode KPIs	Proposed action Request for an ABB fingerprint report Report Prepare maintenance actions and staff
Benefit Save and/or reduce maintenance costs	Benefit Avoid unwanted maintenance actions (eg, removing the pump for repair, just realign machine)	Benefit Plan for relevant maintenance early and avoid downtimes or total damages	Benefit Early planning of maintenance

07

DIGITAL TWINS AND SIMULATIONS

Mitigating internal arc impact

Mitigating internal arc impact in switchgear is a rare but dangerous event. ABB has launched an arc simulation platform that incorporates three gas-flow simulation tools. With this platform, the internal arc withstand capability of a product can be assessed.

01 ABB's new internal arc simulation platform gives designers the tools to minimize arc effects in switchgear.

Unintentional electric arcs created between energized conductors in electrical systems can be highly energetic. These arcs can create plasmas with temperatures well in excess of 10,000°C that drive a fast and violent expansion of the gas, leading to a high-energy explosion →1.

Computer simulations of the temperature and pressure rise in a virtual prototype can be used to assess internal arc withstand capability.

Marley Becerra
Ulf Sand
ABB Corporate Research
Västerås, Sweden

marley.becerra@
se.abb.com
ulf.sand@se.abb.com

Jörg Lehmann
ABB Corporate
Research Baden-Dättwil,
Switzerland

joerg.lehmann@
ch.abb.com

As an example, an arc fault from a 25kA peak short-circuit current of one quarter-second duration releases an energy comparable to that of 2kg of dynamite [1]. Such an explosive energy release stresses – mechanically and thermally – that endanger personnel and seriously damage equipment and structures.

To mitigate the harmful effects of an internal arc fault, the formed gas pressure wave needs to be directed to buffer volumes or to the exterior by using ducts or exhaust channels. In addition,

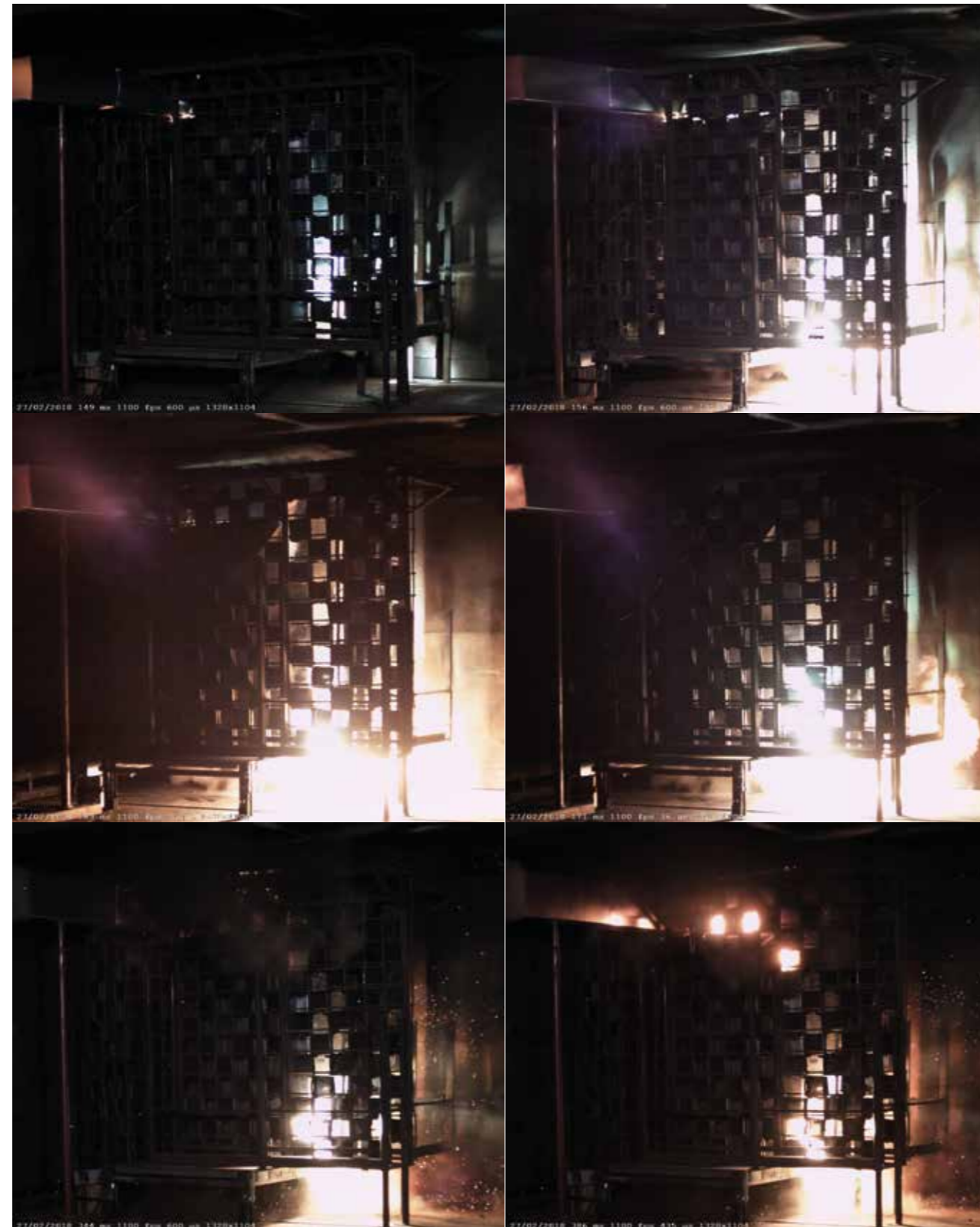

pressure control devices (PCDs) such as openings, metallic meshes, bursting flaps or disks are also used to cool down the gas, to redirect the flow and to limit the maximum permissible pressure. Products designed to protect operating personnel from internal arcing faults are usually labeled as arc-resistant. ABB arc-resistant products are tested using relevant standards (eg, IEC 62271-200 and IEEE C37.20.7) to verify that they can withstand overpressures and release hot gases away from personnel during faults. However, type-testing of such products is a very costly and time-consuming effort.

Computer simulation of internal arcs

Computer simulations of the temperature and pressure rise in a virtual prototype can be used to assess the internal arc withstand capability of a product. When validated, this approach is a valuable and cost-effective tool for cases where tests are not feasible, for early stages of product development or for validation of changes in an already-classified design. Such a simulation can also be used to identify regions in the structure where above-critical pressures will occur in the event of arcing and to locate and dimension appropriate PCDs and exhaust channels/ducts. Moreover, these calculations can provide the input data (forces) for a mechanical analysis to assess potential structural damage due to internal arcs and to virtually test a product.

According to CIGRE [1], the physical processes in internal arc faults can be calculated in different ways, using either basic or enhanced models or even computational fluid dynamic (CFD) calculations. These models all require the current and voltage across the arc fault as input, but

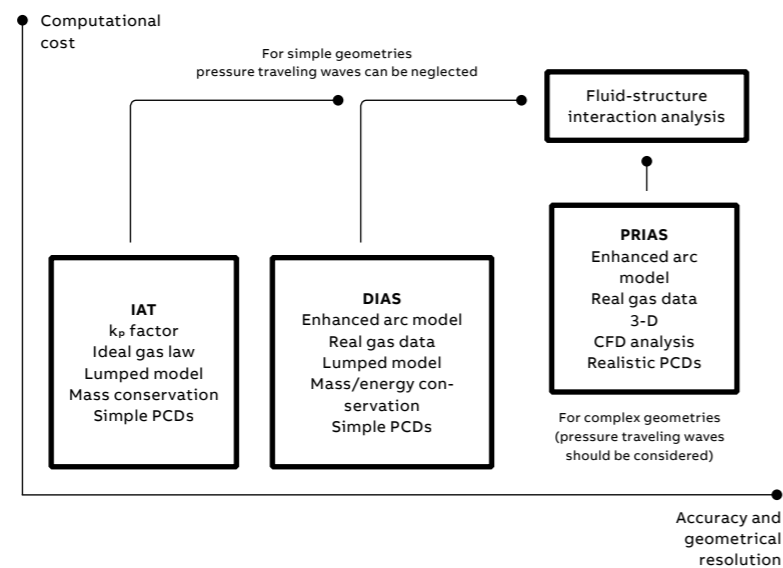

02

they differ in complexity, predictive power and simulation effort. These differences are related to the simplifying assumptions they use regarding:

- Arc representation: The internal arc fault is generally represented as a simple heating source by using the empirical fitting factor k_p . This factor represents the net fraction of the electrical arc energy that leads directly to the increase of pressure [1]. Alternatively, the arc can be modeled by using energy and mass sources including different physical processes (eg, radiation, metal vaporization, etc.).
- Gas properties: The thermodynamic properties of the gas are considered as constant values or as temperature- and pressure-dependent variables using real gas data.
- Geometry: The compartments containing the gas in the fault can be modeled as non-dimensional, lumped volume zones or three-dimensional (3D) zones corresponding to the real geometry of the device.
- Flow analysis: The flow can be evaluated by using conservation of average energy and mass in the volumes (neglecting the effects of pressure traveling waves). It can also be spatially resolved in detail using a CFD analysis.
- PCDs: PCDs are represented as simple openings with a known flow efficiency factor or they can be modeled in CFD considering their actual resistance to the flow (also including the rotational or translational motion of flaps and bursting disks).

Three different tools with different levels of accuracy, geometrical resolution and computational cost have been developed by ABB.

In order to meet the needs of internal and external customers, three different tools with different levels of accuracy, geometrical resolution and computational cost have been developed by ABB. These tools are known as IAT (internal arc tool), DIAS (DymoDAT-based internal arc simulations) and PRIAS (pressure rise in internal arc simulation) and their general features are shown in →2. These tools allow the assessment of the impact of internal arc faults in a broad spectrum of applications: from rapid calculations while tendering switchgear and substations, through investigations of internal arc incidents in already-installed units to product development.

IAT internal arc tool

IAT is a fast simulation tool using a basic internal arc model with the empirical fitting factor $k_{p,p}$ that has already been extensively described in a previous ABB Review article [2]. IAT is distributed as an executable file for installation on computers using Microsoft Windows. A simulation case can be set by filling in input data textboxes in the IAT graphical user interface (GUI) and can be run in any computer in a few tens of seconds. It has been validated for internal arc faults in air and SF₆.

— 02 General description of the internal arc simulation ABB tools.

— 03 Example of the representation volumes and connecting PCDs in DIAS.

Due to the simplifications used, there are some limitations regarding the accuracy and predictive power of the IAT calculations. Some accuracy issues can occur for temperatures above 6,000K in air and 2,000K in SF₆ [2]. Since the calculations are based on lumped volumes, IAT cannot resolve traveling pressure waves in space and uses average

PRIAS allows the accurate evaluation of the flow, taking traveling pressure waves into account.

values instead. Therefore, it has limitations for the evaluation of pressure waves travelling along elongated objects such as long ducts and exhaust channels. It also cannot resolve the motion of bursting disks and flaps.

DIAS DymoDAT-based internal arc simulations

DIAS is a tool that provides a fast simulation based on an enhanced lumped model for mass and energy conservation. Its core stems from the ABB internal tool DymoDAT for describing the pressure build-up during high-voltage circuit breaker operations [3]. An internally developed, enhanced arc model that includes physical models of the most important effects, such as electrode erosion, is central to

the tool. Exothermic reactions between eroded electrode material and filling gas are considered within a real model of the gas or plasma [4]. Consequently, a k_p factor is not required as a fitting parameter and a valid description of gas properties over a wide range of temperatures and pressures is obtained. The gas flow between different device compartments is approximated by standard gas dynamics relations and can be corrected by effectively reduced flow areas. The opening dynamics of burst disks and flaps are taken into account by prescribing an opening time after a given overpressure has been reached. →3.

DIAS requires the installation of the commercial simulation platform Dymola, which also provides the GUI for entering model parameters and evaluating the results. Simulation times are around one second on standard computing hardware. The predictions of DIAS have been validated for a large set of internal arc faults in SF₆- and air-filled equipment with copper or aluminum electrodes.

PRIAS – pressure rise in internal arc simulation

PRIAS is an accurate and complex CFD simulation tool intended to complement the IAT and DIAS tools by resolving, in three dimensions, all the flow parameters. It allows the accurate evaluation of the flow, considering traveling pressure waves, which cannot be resolved within a lumped description. PRIAS has been developed by ABB as a collection of scripts running on the third-party CFD software ANSYS Fluent under Linux. In contrast to the other tools, PRIAS requires a detailed description of the analyzed geometry and the PCDs in order to generate the CFD-compatible mesh required as input. Up until now, the predictions of PRIAS have been validated for internal arcs in air only.

A simulation with PRIAS must be run on a high-performance computer cluster and usually takes under two days. However, the typical simulation workflow (from the planning of a calculation task to its setup and then its execution) can take from several days to a few weeks. For this reason, PRIAS is mainly aimed at high-end simulations in complex configurations where lumped calculations are not accurate or sufficient or where the behavior of PCDs is not known beforehand. Furthermore, PRIAS is recommended for simulations in structures containing elongated parts (such as ducts or exhaust channels) or in large structures with several PCDs installed along the periphery, where the effect of pressure traveling waves should be accounted for. In those cases, PRIAS can also be used for the more complicated simulation of the fluid-structure interaction

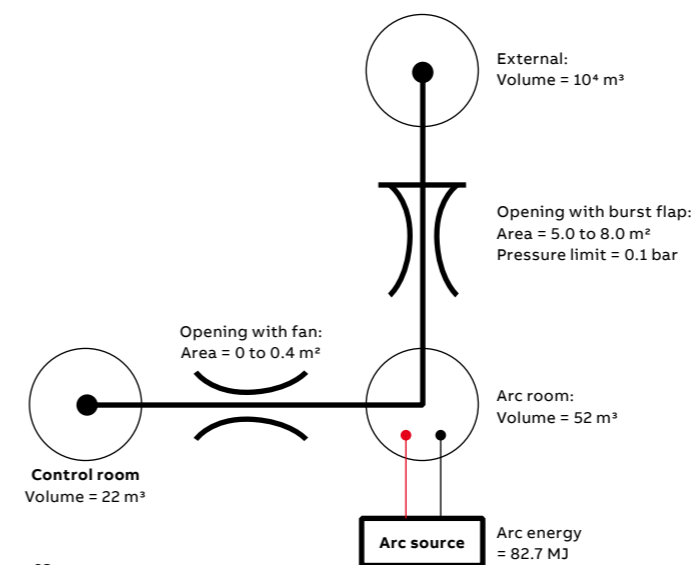

03

necessary to evaluate mechanical damage due to internal arcs. An example of the PRIAS simulation for air-insulated, medium-voltage switchgear, including dynamically moving bursting disks, is illustrated in →4.

ABB-internal arc simulation platform

In order to have a common platform across ABB for the development, archiving and usage of the arc simulation tools, an internal ABB SharePoint site has been set up. The platform also allows the coordination of development activities between the service providers and the software development teams. The site platform is administrated by arc simulation specialists.

An application example: Alba PL6

In 2016, a detailed investigation of the pressure build-up and structural impact of an arc failure in the Alba PL6 container rectifier was commissioned. The investigation involved finding an improved design, including the specification and positioning of PCDs. The main target was to reach an optimal structural design for an arc-safe rectifier container that allowed effective relief of pressure to the exterior.

The investigation was conducted in steps, initially using DIAS to roughly determine the overall opening areas of bursting flaps, without involving geometrical details and aspects of flow in the rectifier container.

Once the DIAS simulations were complete, the task focused on calculations with PRIAS under the detailed conditions of the flow and the pressure on the arcing and service rooms in the rectifier.

Field experience has shown that the overpressures calculated are very close to the values measured during an internal arc test on the same object.

Using these calculations, the number of bursting flaps and their location were found such that the overpressures generated were minimized →5.

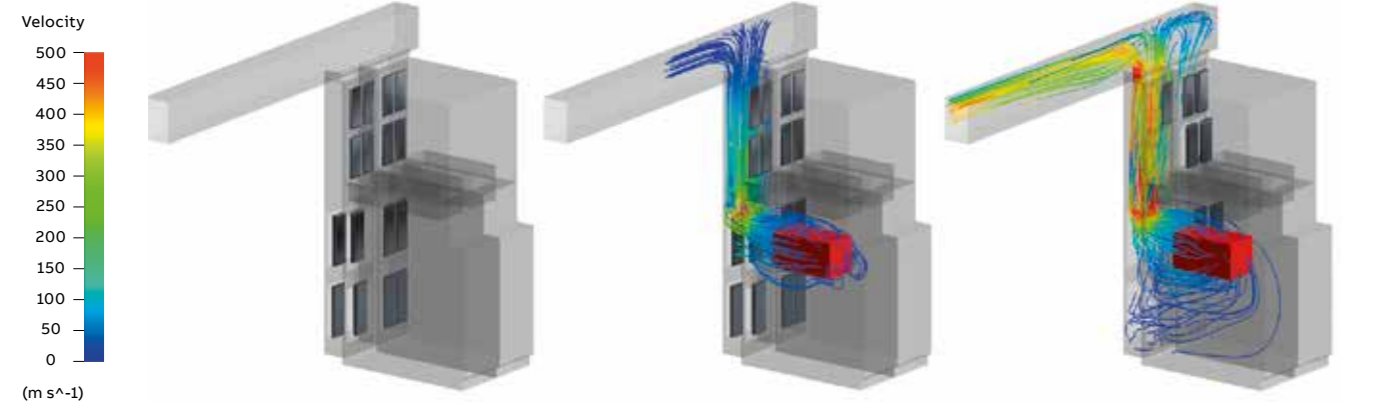

04

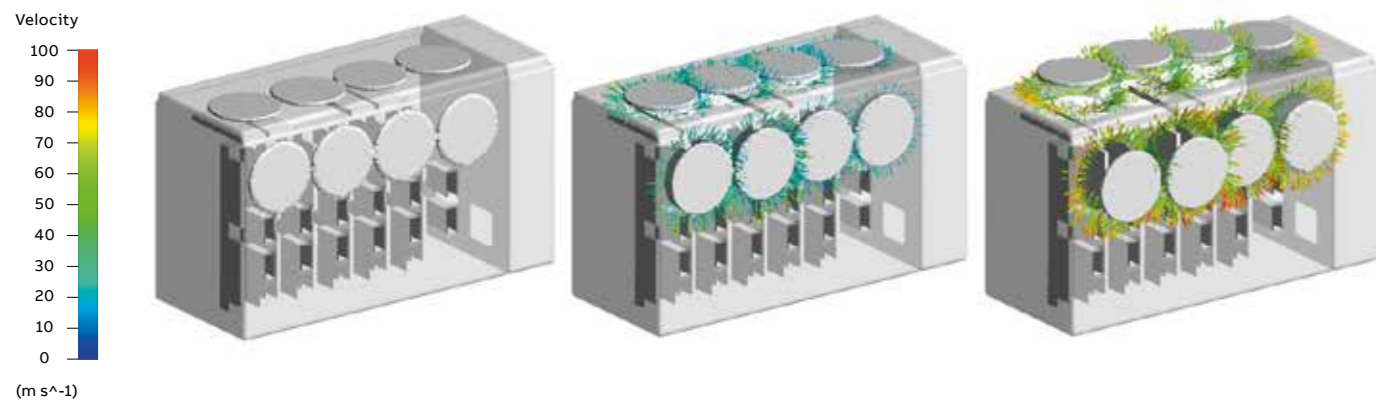

05

References

[1] CIGRE WG A3.24, "Tools for simulation of the internal arc effects in HV and MV switchgear," Electra, 2015.

[2] E. Dullni et al., "Feeling the pressure: Simulating pressure rise in switchgear installation rooms," ABB Review, 3/2013, pp. 54–59.

[3] J. Lehmann et al., "A Modelica library for High-Voltage AC Circuit-Breaker Modeling," Proceedings of the 7th International Modelica Conference, Como, September 20–22, 2009, pp. 855–860.

[4] C. Doiron and K. Hencken, "Calculation of thermodynamic and transport properties of thermal plasmas based on the Cantera software toolkit," Proceedings of the XXII Europhysics Conference on Atomic and Molecular Physics of Ionized Gases, Greifswald, July 15–19, 2014.

04 Velocity streamlines simulated by PRIAS for switchgear at three different time steps.

05 Detailed PRIAS simulation of the bursting flaps in the rectifier at three different times.

06 Simulated structural displacement at arc failure induced peak pressure, based on pressure distribution from PRIAS (surface-average).

In the next step, the pressure and forces on the walls and surfaces estimated with PRIAS were used to assess the structural integrity of the system using 3D finite element simulations (the ABAQUS finite element analysis software suite was used). The structural response from the arc failure was investigated in terms of wall displacement, plastic strains, stress on welds and force on joints →6.

Cost-effective and fast

Although internal arcing is a rare event, its effects can be devastating – and even fatal. The simulation tools discussed here provide an effective means to design internal-arc-prone electrical enclosures in a way that massively reduces the detrimental effects of these events. The tools have, for example, been used for a new efficient design process for rectifier container and pressure relief device dimensioning. Further, field experience has shown that the overpressures calculated are very close to the values measured during an internal arc test on the same object. The platform provides a very cost-effective approach too: in one case, it was possible to simulate the pressure rise inside a pressurized unit at internal arcing for one-twentieth the cost of physical testing.

In one case, it was possible to simulate the pressure rise inside a pressurized unit at internal arcing for one-twentieth the cost of physical testing.

The platform can radically shorten development timescales. In one example, it supported the decision between a complete redesign or an improvement to the existing design, thus saving hundreds of thousands of dollars. Furthermore, the platform provides a way to demonstrate to a customer the efficacy of a particular cabinet, container or room design in a very short time. •

Displacement (mm)
(max = 176 mm)

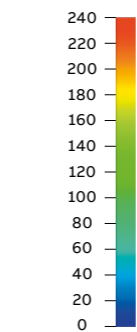

06



Productivity



Bespoke design is the natural enemy of efficiency and reliability, since there's no track record to inform future expectations. Modular processes, however, can serve like sturdy building blocks, giving engineers tools that drastically reduce the time and variability it takes to design processes, especially those applicable to automated systems. ABB is advocating for this development.

72 Process module engineering

MODULAR PROCESS PLANTS: PART 1

Process module engineering

ABB is in an industry/academic consortium that develops concepts for automating modular process plants. This article discusses the function-oriented – in contrast to traditional tag-based – architecture of modular plants. A companion article, in a future ABB Review, will describe pilot applications.



01 Modern process plants are complex undertakings that require new engineering and operation concepts. A modular automation-enabled process automation approach overcomes many of the challenges of process plants.

02 Engineering workflow of modular process plants [1].

03 Architecture of ABB's modular automation system.

Katharina Stark
Mario Hoernicke
ABB Corporate Research
Ladenburg, Germany

katharina.stark@de.abb.com
mario.hoernicke@de.abb.com

Axel Haller
ABB Automation GmbH
Industrial Automation,
Mannheim, Germany

axel.haller@de.abb.com

Ralf Jeske
ABB Automation GmbH
Industrial Automation
Minden, Germany

ralf.jeske@de.abb.com

Henry Bloch
Alexander Fay
Helmut-Schmidt University
of Hamburg
Hamburg, Germany

Alexander Wittenbrink
Invite GmbH
Leverkusen, Germany

Torsten Knohl
Bayer AG
Leverkusen, Germany

Stephan Hensel
Leon Urbas
Anna Menschner
Technical University
of Dresden
Dresden, Germany

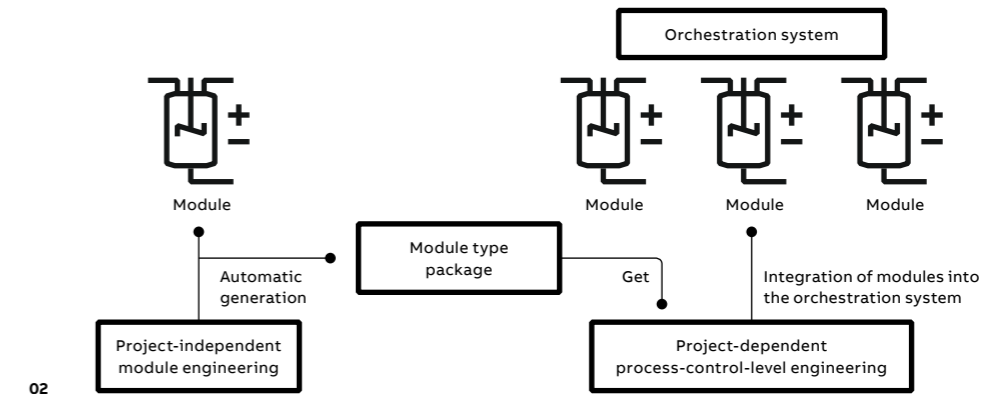

Since 2014, ABB, Bayer, the Technical University of Dresden, INVITE (a public-private partnership of TU Dortmund and Bayer Technology Services GmbH) and the Helmut-Schmidt University of Hamburg →5 have been working together on concepts for automating modular process plants.

In contrast to traditional plants, modular plants are not assembled using tag-based engineering but instead employ a function-oriented approach, comparable to object- or service-oriented concepts from software development →1. This new automation system architecture requires new engineering and operation concepts.

Modularization of process plants is seen as a promising way to solve upcoming requirements.

To help supply these, this project has focused on a modular automation-enabled process automation solution. This article describes modular process plants and will show the results of research executed in this context. Pilot applications will be described in a companion article, to be published in a future edition of ABB Review.

About modular process plants

Modularization of process plants is seen as a promising way to solve upcoming requirements from the process industries, such as improved flexibility and interoperability between plant assets. For that reason, several working groups within the German user association of automation technology in process industries (NAMUR) have

been established to work together with ZVEI (German association of automation technology vendors) to create requirements and concepts for the automation of modular plants. The expected result is a definition of a process module interface, the so-called module type package (MTP), that allows seamless integration of process modules into an orchestration system [1] →2.

Within the MTP, the automation interfaces required for the communication between the module automation system and the overlying orchestration system are specified. The MTP is used to identify the functionality and communication interfaces of a modular automation system and is, therefore, the key to the low automation engineering effort promised by modular plant architectures.

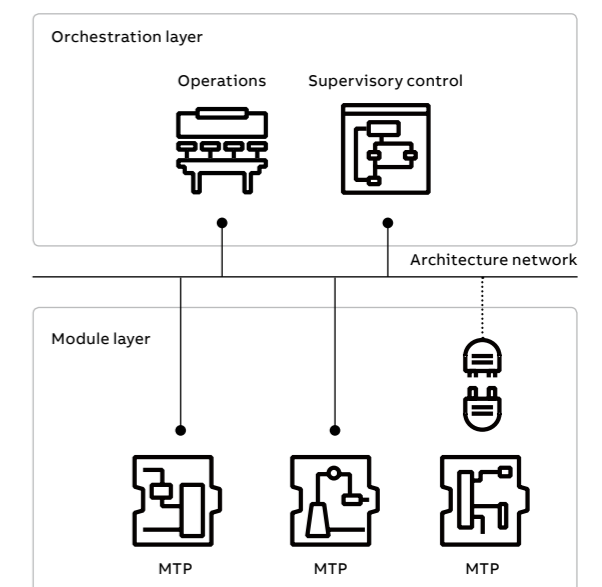

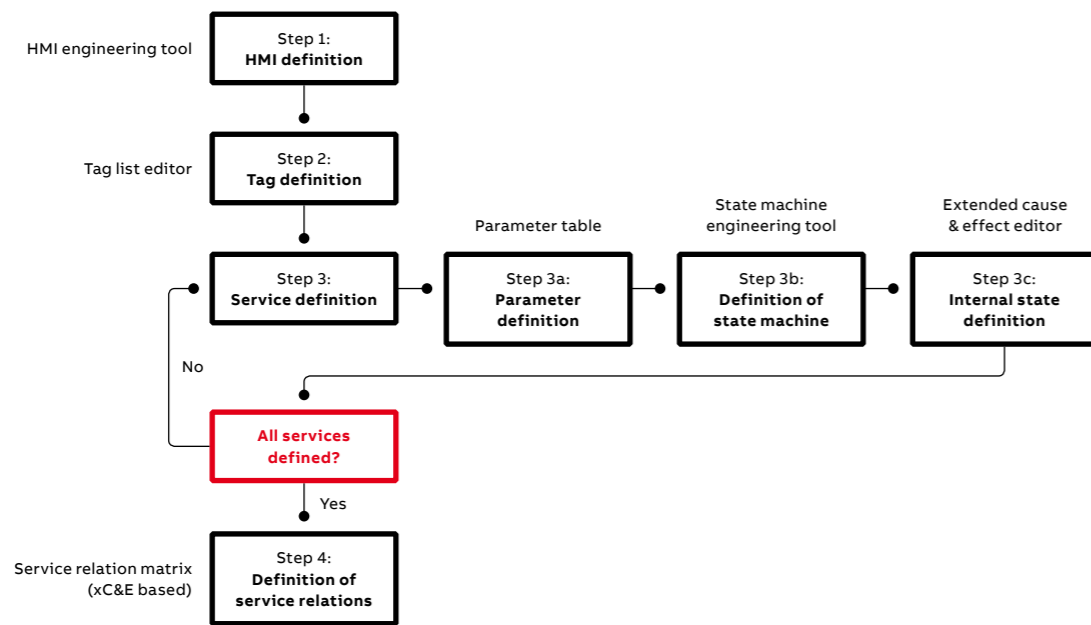

04

Scope of the research project

Each partner was accountable for a specific part of the project: The universities selected the useful technologies and developed concepts; ABB then developed the prototype based on these concepts, integrating it into the ABB tool landscape, using the ABB Extended Automation System 800xA and the ABB Freelance DCS (distributed control system). Working together with INVITE the prototype was then used to run a pilot based on a Bayer plant to show that the overall concepts fit the given requirements.

By controlling the services in the correct order, the integrated modules will work together and fulfill the requirements for the specific plant.

The prototype led to a product that is usable for a modular automation system [2]. The input given to the working groups of NAMUR, ZVEI and VDI/VDE led to the specification of a standard – VDI/VDE/NAMUR Guideline 2658 “Automation Engineering of Modular Systems in Process Industry” – which specifies the MTP.

Modular automation layers

A modular automation system has two layers: the module layer, which is a small controller executing the logic of a single process module, and the orchestration layer, which integrates process modules in order to combine them into one process plant. For each layer, different automation systems have been chosen. A network connects the layers →3.

A specialty of modular process plants, compared to conventional plants, is that the modules are not orchestrated in a tag-based way. Every module provides a set of encapsulated process functions, called services, that can be orchestrated from a supervisory control system. Every service describes a process function, such as mixing, tempering or heating. By controlling the services in the correct order, the integrated modules will work together and fulfill the requirements for the specific plant.

The engineering is done differently, too. First, the module types are engineered. These module type descriptions can later be integrated into the supervisory system; instances can be created. By re-using modules of the same type, the engineering effort for the plant can be dramatically reduced →6.

04 Proposed engineering workflow for a module.

05 The Helmut Schmidt University in Hamburg, Germany, is one of one of the partners working with ABB on concepts for automating modular process plants. (Photo courtesy of The Helmut Schmidt University).

06 By re-using modules of the same type, the engineering effort involved in automating plants such as the one shown here can be dramatically reduced.



05

The MTP facilitates integration of the modules.

Even though the pilot application only uses ABB components, it would be possible to integrate third-party modules. The system is fully compliant with VDI/VDE/NAMUR 2658 part 1–3 [3–5].

The communication between the module layer and the orchestration layer is done using OPC UA. Every module provides an OPC UA server that exposes the module's services and tags to the supervisory control system.

By re-using modules of the same type, the engineering effort for the plant can be dramatically reduced.

The supervisory control system is an OPC UA client that connects to the modules' OPC UA servers and uses those to communicate the required commands to the module.



06

For the module layer, where usually only a few I/Os have to be controlled, a smaller automation system, like a Freelance AC700F controller or the B&R X20 family, can be used, for instance.

For the orchestration layer, System 800xA has been chosen. In a first step, System 800xA is used for the visualization and supervisory control of the modular plant. When the specification of the MTP is developed further, with System 800xA, the new features (like alarm and event handling, information and history management) can be added easily.

Module layer

The module layer represents the functions that the process plant needs to fulfill its purpose. The module layer is assembled from the needed module types, which can be chosen by the engineer.

In a first engineering step, the modules have to be engineered. The module type engineering is based on the standard [3–6] in a vendor-neutral way and later, when the engineering has finished, the required automation system is chosen.

Module type engineering

The engineering of the module types has been designed to fit with the different aspects that are described in the MTP. At present, the aspects that are already (partly) defined within the community are:

- Definition of communication with a module [3]
- Definition of HMIs (human-machine interfaces) of modules [4]
- Definition of tags of modules [5]
- Definition of services of modules [6]

In future, the guideline will include further aspects, such as alarm management and safety, which is not defined at present. Nevertheless, the general concepts should work for those aspects, as well.

For the module type engineering process, a four-step, top-down approach is proposed →4. Unlike the engineering of conventional plants, the HMI is engineered first.

In future, the guideline will include further aspects, such as alarm management and safety, which is not defined at present.

The HMI consists of symbols and lines that visualize the equipment and process flow →7. While defining the symbols and giving them a tag name, the tag list with the used process equipment is automatically generated. After the creation of the HMI, the tag list contains all required tags and the tag parameters

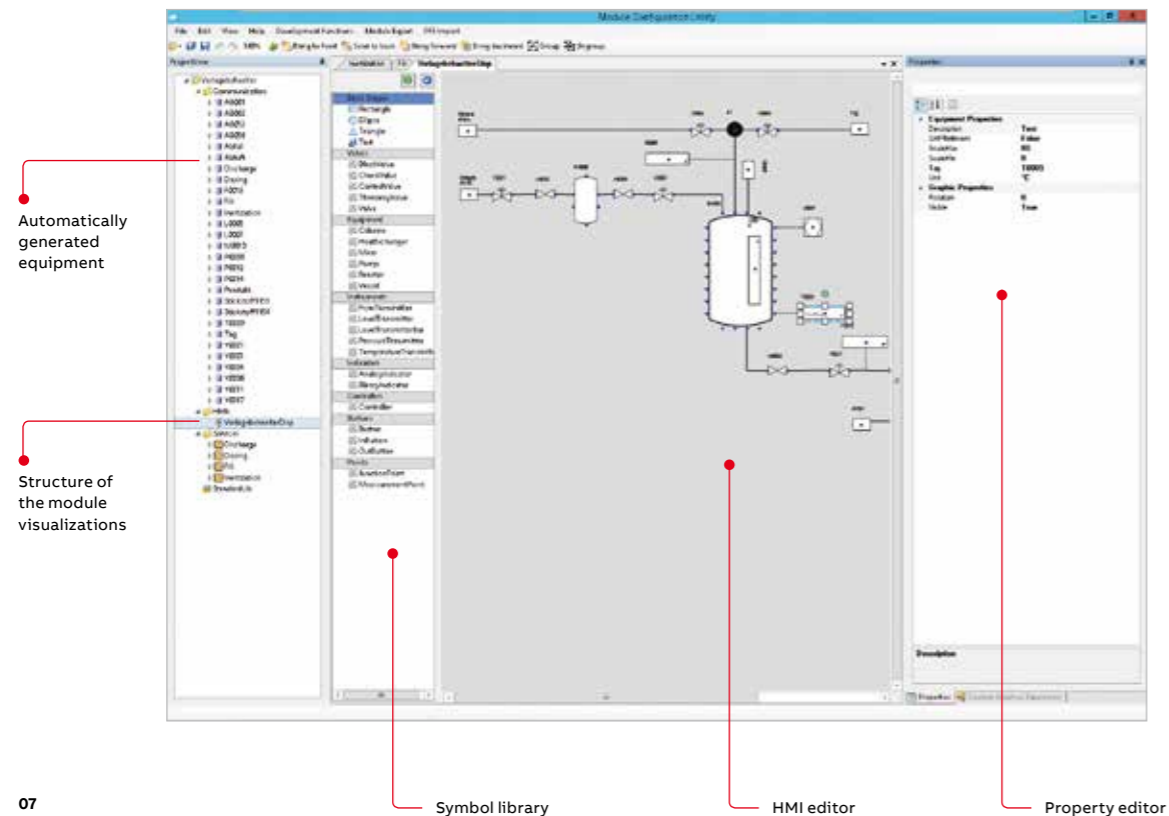

07

Symbol library

HMI editor

Property editor

— 07 HMI editor for a module.

— 08 Tag editor for a module.

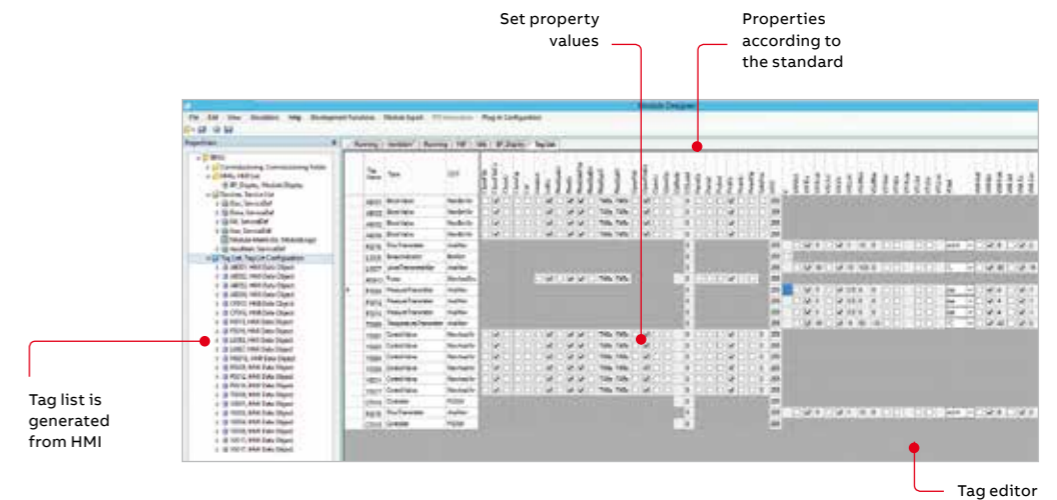

08

References

[1] Jens Bernshausen et al., "NAMUR Module Type Package – Definition," atp edition, 58 (1–2), pp.72–81, 2016.

[2] ABB launches world's first commercial modular enabled process automation solution." Available: <https://new.abb.com/news/detail/5035/abb-launches-worlds-first-commercial-modular-enabled-process-automation-solution>

[3] VDI, The Association of German Engineers, "VDI/VDE/NAMUR 2658: Automation Engineering of modular systems in the process industry. Part 1: General concept and interfaces," January 2018.

[4] VDI, The Association of German Engineers, "VDI/VDE/NAMUR 2658 (Draft): Automation Engineering of modular systems in the process industry. Part 2: Modelling of HMIs."

[5] VDI, The Association of German Engineers, "VDI/VDE/NAMUR 2658 (Draft): Automation Engineering of modular systems in the process industry. Part 3: Base library."

[6] VDI, The Association of German Engineers, "VDI/VDE/NAMUR 2658 (Draft): Automation Engineering of modular systems in the process industry. Part 4: Services."

can be engineered →8. This is done within a tag list editor, similar to a tag list of a conventional plant.

Within the third step, the services of the module type are engineered. Every service is used to fulfill a process function of the module. A module might have just one or several services in order to fulfill its process step(s) or part of a process step.

By using this method, fully functional software for the automation system is generated without having any manual effort.

Based on the information engineered for a module type, the automation logic for the target system (here, Freelance) and the module type package can be automatically generated from the tool.

For Freelance, several code fragments are generated that can be imported into a Freelance project and immediately downloaded to a controller.

From the service definition, the automation logic for Freelance can be generated. For each service, a state-machine is produced that implements the states defined in the editor. In order to define the logic to be executed in every state, an extended cause and effect (xC&E) editor can be used to engineer the service behavior. The state logic is automatically generated and can be executed

immediately after the import, with no further manual effort. Since the module HMI is shown in the process orchestration layer (POL), there is no need to generate an HMI for the module automation system. The module automation system only consists of the control for the equipment and the services.

By using this method, fully functional software for the automation system is generated without having any manual effort.

The future of modular automation

The techniques presented here for automating modular process plants dramatically reduce engineering effort. The project has delivered valuable input for MTP standardization and the software products resulting from the project will further facilitate the roll-out of this approach to modular process plants across wider sections of the industry. Future research will investigate further aspects of modular automation systems – for example, alarm management, history management, advanced process control, intermodule communication, change management and simulation and testing of modular plants. Those topics will shape the future of the process industry. •



BUZZWORD DEMYSTIFIER

Cloud, edge and fog computing

The eighth installment of ABB Review’s Buzzword Demystifier parts the mists and explains cloud, edge and fog computing, and how these relate to ABB Ability™.



Christopher Ganz
Group Technology Management
Zurich, Switzerland

christopher.ganz@ch.abb.com

Once upon a time, most industrial computing was performed in computing infrastructures local to the process concerned. This required substantial computing power to be embedded into the relevant devices, such as robots, automation controllers and

The ABB Ability digital platform provides the capabilities to implement complex digitalization offerings at the edge.

sensors. With the advent of the cloud, it became possible to locate computing capabilities in high-performance data centers and reduce local requirements. This migration was also driven by local computing devices – eg, smartphones or tablets – becoming more mobile but less able to hold and process data.

However, a wholesale move of data and processing from the front end to the cloud is not always good. There are, for instance, issues with latency: Process sensors often control actuators that have to react quickly to keep the process on track. Further, anything that is required to keep a process safe and stable is best executed close by. Another factor is the bandwidth occupied by large data transfers.

Data privacy, too, may be a reason for leaving data where it is.

These considerations have given rise to the term “edge computing,” referring to the edge of the cloud. Is, then, edge computing not just computing as it was known before the cloud came along? The answer is “no” – the edge is local computing in the context of a cloud environment →1.

ABB Ability

As a core element of ABB’s digital strategy, the ABB Ability platform is defined to encompass all digital components, from the device, to the automation system, to plant and enterprise level software, up to the cloud. The ABB Ability digital platform provides the capabilities to implement complex digitalization offerings at the edge, using ABB’s automation offerings, and combine them with plant-level optimization. ABB Ability also allows the connectivity of these offerings to the cloud to enable larger-scale collaboration throughout a customer’s ecosystem.

Cloud advantages

Sometimes the use of edge versus cloud is a design decision. Scalability is one determining factor: The cloud has advantages here regarding infrastructure, platform facilities, or provision of software-as-a-service (SaaS). Computing resources



01

01 At the 2017 Hannover Messe, B&R (an ABB company) presented its Orange Box, an edge device. The Orange Box enables machine operators to collect and analyze data from previously isolated machines and lines and get them fit for the smart factory with a minimal effort. The controller collects operating data from any machine via its I/O channels or a fieldbus connection. From this data, so-called maps generate and display OEE (overall equipment effectiveness) ratings and other KPIs, and can also share the information with higher-level systems via OPC UA.

can be made available dynamically – ideal when computational needs vary greatly. Collaboration is another factor – for example, where data has to be shared between organizations.

Combining functionality “as a service” on the cloud level with an on-site edge installation can bring cloud benefits to the plant. This also enables a cloud-based “as a service” business model for edge components. For example, benchmarking KPIs (key performance indicators) can be calculated at the edge, with analysis, comparison, and visualization done in the cloud. A customer provides the data and receives the benchmark results as a service. Analytics and optimization can follow a similar scheme.

Fog computing

Some tasks can be performed either in the cloud or at the edge. Here, full software portability between cloud and edge is a prerequisite. Software functionality can be offered in the cloud, or on-site. This duality postulates that the on-site infrastructure is a cloud at the edge and this arrangement is sometimes referred to as “fog computing.” All clear? •

Photo page 78: MediProduction, istockphoto.com; bottom of page 79: Franck-Boston, istockphoto.com



Imprint

Editorial Board

Bazmi Husain
Chief Technology Officer
Group R&D and Technology

Adrienne Williams
Senior Sustainability
Advisor

Christoph Sieder
Head of Corporate
Communications

Reiner Schoenrock
Technology and Innovation

Roland Weiss
R&D Strategy Manager
Group R&D and Technology

Andreas Moglestue
Chief Editor, ABB Review
andreas.moglestue@ch.abb.com

Publisher

ABB Review is published by ABB Group R&D and Technology.

ABB Switzerland Ltd.
ABB Review
Segelhofstrasse 1K
CH-5405 Baden-Daettwil
Switzerland
abb.review@ch.abb.com

ABB Review is published four times a year in English, French, German and Spanish. ABB Review is free of charge to those with an interest in ABB’s technology and objectives.

For a subscription, please contact your nearest ABB representative or subscribe online at www.abb.com/abbreview

Partial reprints or reproductions are permitted subject to full acknowledgement. Complete reprints require the publisher’s written consent.

Publisher and copyright ©2019 ABB Switzerland Ltd. Baden/Switzerland

Printer

Vorarlberger Verlagsanstalt GmbH
6850 Dornbirn/Austria



Layout

Publik. Agentur für Kommunikation GmbH
Ludwigshafen/Germany

Artwork

Konica Minolta Marketing Services
London
United Kingdom

Disclaimer

The information contained herein reflects the views of the authors and is for informational purposes only. Readers should not act upon the information contained herein without seeking professional advice. We make publications available with the understanding that the authors are not rendering technical or other professional advice or opinions on specific facts or matters and assume no liability whatsoever in connection with their use.

The companies of the ABB Group do not make any warranty or guarantee, or promise, expressed or implied, concerning the content or accuracy of the views expressed herein.

ISSN: 1013-3119

abb.com/abbreview

Tablet version

Production of the tablet version of ABB Review (for both iOS and Android) has been discontinued at the end of 2018. Readers of the tablet versions are recommended to use the pdf or web versions instead. abb.com/abbreview

Stay informed ...

Have you ever missed a copy of ABB Review? Sign up for the e-mail alert at abb.com/abbreview and never miss another edition.



Please note that when you register for this alert, you will receive an e-mail with a confirmation link. Please ensure that you have confirmed your registration.

—
Next 03/2019

Autonomous systems

It often seems as though the future arrives first on the factory floor, yet only in fits and starts, not as a unified, revealed truth. The IIoT, Industry 4.0, the cloud, autonomous production, edge computing, machine learning and artificial intelligence each promise future improvements. The next issue of ABB Review will explore real-time opportunities that integrate and implement these technologies.