



The Company

We are an established world force in the design and manufacture of instrumentation for industrial process control, flow measurement, gas and liquid analysis and environmental applications.

As a part of ABB, a world leader in process automation technology, we offer customers application expertise, service and support worldwide.

We are committed to teamwork, high quality manufacturing, advanced technology and unrivalled service and support.

The quality, accuracy and performance of the Company's products result from over 100 years experience, combined with a continuous program of innovative design and development to incorporate the latest technology.

The UKAS Calibration Laboratory No. 0255 is just one of the ten flow calibration plants operated by the Company, and is indicative of our dedication to quality and accuracy.

EN ISO 9001:2000



Cert. No. Q5907

EN 29001 (ISO 9001)



Lenno, Italy – Cert. No. 9/90A

Electrical Safety

This instrument complies with the requirements of CEI/IEC 61010-1:2001-2 "Safety requirements for electrical equipment for measurement, control, and laboratory use". If the instrument is used in a manner NOT specified by the Company, the protection provided by the instrument may be impaired.

Symbols

One or more of the following symbols may appear on the instrument labelling:

	Warning – Refer to the manual for instructions		Direct current supply only
	Caution – Risk of electric shock		Alternating current supply only
	Protective earth (ground) terminal		Both direct and alternating current supply
	Earth (ground) terminal		The equipment is protected through double insulation

Information in this manual is intended only to assist our customers in the efficient operation of our equipment. Use of this manual for any other purpose is specifically prohibited and its contents are not to be reproduced in full or part without prior approval of the Technical Communications Department.

Health and Safety

To ensure that our products are safe and without risk to health, the following points must be noted:

1. The relevant sections of these instructions must be read carefully before proceeding.
2. Warning labels on containers and packages must be observed.
3. Installation, operation, maintenance and servicing must only be carried out by suitably trained personnel and in accordance with the information given.
4. Normal safety precautions must be taken to avoid the possibility of an accident occurring when operating in conditions of high pressure and/or temperature.
5. Chemicals must be stored away from heat, protected from temperature extremes and powders kept dry. Normal safe handling procedures must be used.
6. When disposing of chemicals ensure that no two chemicals are mixed.

Safety advice concerning the use of the equipment described in this manual or any relevant hazard data sheets (where applicable) may be obtained from the Company address on the back cover, together with servicing and spares information.

CONTENTS

Section	Page
1 INTRODUCTION	2
2 SETTING UP	3
2.1 Instrument Power-up	3
2.2 Simple Fault-finding	3
3 DISPLAYS & CONTROLS	4
3.1 Displays and LED Indicators	4
3.2 LED Indication	4
3.3 Use of Controls	5
4 GENERAL OPERATION	6
5 OPERATING LEVEL	7
5.1 Operating Page Introduction	7
5.1.1 Set Point Tracking	7
5.1.2 Auto/Manual Transfer	7
5.1.3 Heat/Cool Control	7
5.2 Operating Page Displays	8
5.2.1 Time Proportioning and Analog Control	8
5.2.2 Motorized Valve Control ...	9
5.2.3 Heat/Cool Control	10
5.3 Operating Page Messages	11
5.4 Alarm Acknowledge Page	13
5.4.1 Mode Alarm Trips	13
5.5 Access to Configuration Levels..	14
5.5.1 Security Code Page	14
6 TUNING LEVEL	15
6.1 Introduction to Self-tuning	15
6.2 Self-tuning Page	16
6.3 Self-tune Diagnostic Messages .	20
7 CONTROL LEVEL	21
7.1 Introduction to Standard Control	21
7.2 Control Page	23
7.3 Introduction to Heat/Cool Control	25
7.3.1 Control Page (Heat/Cool Control)	26
7.3.2 Calculating the Crossover Value	28
7.3.3 Calculating the Transition Bandwidth Value	28
8 PROFILE OPERATION	29
8.1 Profile Operating Page	29
8.2 Profile States Page	30

1 INTRODUCTION

The COMMANDER 300 Series of documentation is shown in Fig. 1.1. The **Standard Manuals**, including the specification sheet, are supplied with all instruments. The **Modbus Supplement** is supplied with instruments configured for Modbus Serial Communications.

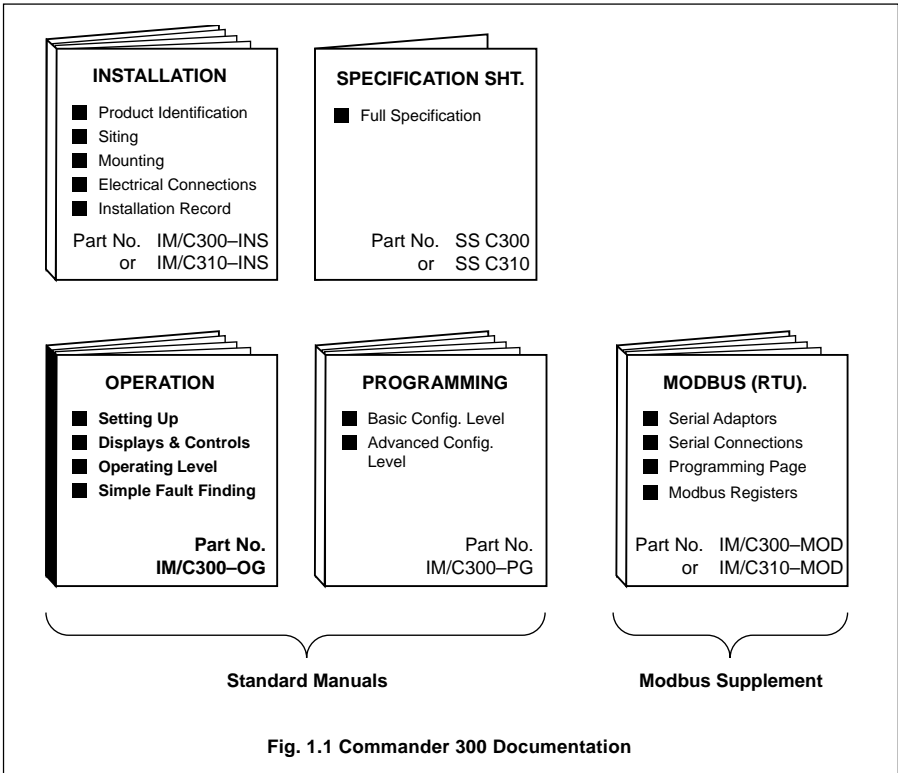

Fig. 1.1 Commander 300 Documentation

2 SETTING UP

2.1 Instrument Power-up – Fig. 2.1

Caution. Ensure that all connections, especially to the earth stud, are made correctly.

- Check that the input sensors are installed correctly.
- Switch on the supply to the instrument, any power-operated control circuits and the input signals.
- The start-up sequence shown in Fig. 2.1 is displayed when the supply is first switched on.

2.2 Simple Fault-finding

If the instrument does not appear to be working satisfactorily, carry out the following checks before contacting the Service Organization:

- Are all connections made correctly?
- Is there power to the instrument?
- Is there a signal at the process variable input and/or the control output terminals?

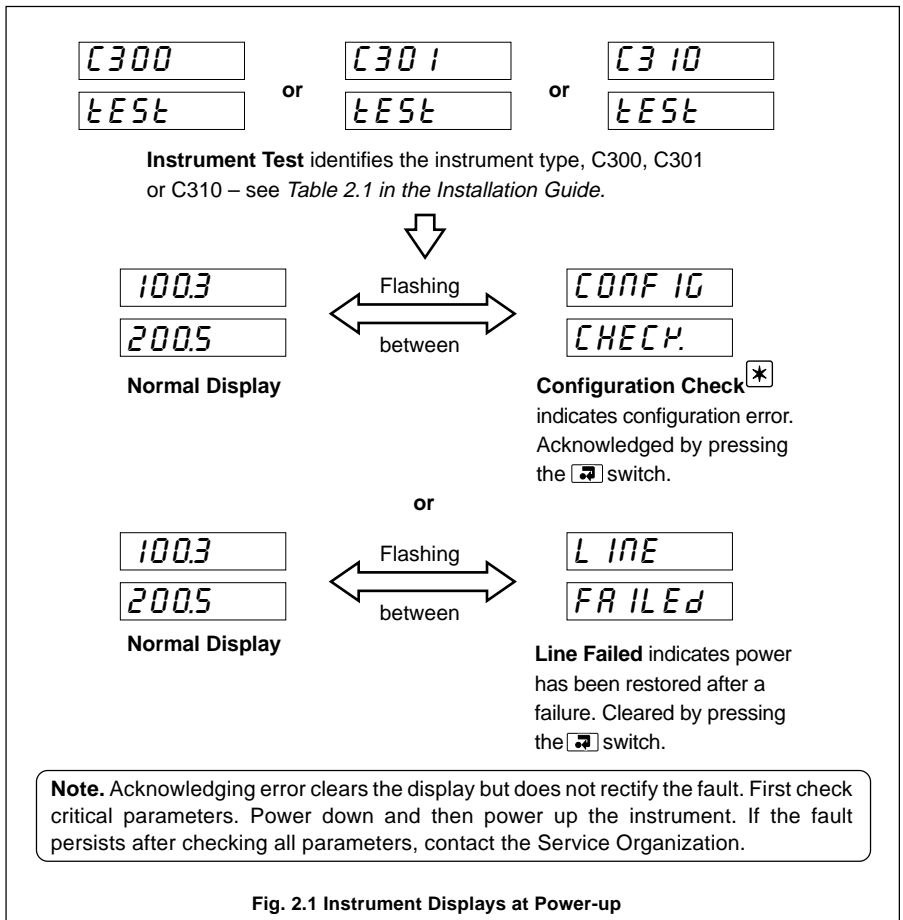

Fig. 2.1 Instrument Displays at Power-up

3 DISPLAYS & CONTROLS

The displays, i.e.d. indicators and operation/programming controls are located on the faceplate on the front of the instrument.

3.1 Displays and LED Indicators – Fig. 3.1

The displays comprise 2 rows of 6 characters.

A	<i>A</i>	L	<i>L</i>
B	<i>b</i>	M	<i>-</i>
C	<i>C or c</i>	N	<i>n or n</i>
D	<i>d</i>	O	<i>0 or o</i>
E	<i>E</i>	P	<i>P</i>
F	<i>F</i>	Q	<i>Q</i>
G	<i>G</i>	R	<i>r</i>
H	<i>H or h</i>	S	<i>S</i>
I	<i>I</i>	T	<i>t</i>
J	<i>J</i>	U	<i>U</i>
K	<i>K</i>	V	<i>V</i>
		Y	<i>y</i>

Table 3.1 Character Set

3.2 LED Indication – Fig 3.1

LED indications are as follows:

A1 Alarm states for alarms 'A' to 'E' – see *Section 4.11 in Programming Guide*.

A2 Alarm states for alarms 'F' to 'K' – see *Section 4.11 in Programming Guide*.

LED Flashing – alarm active but not acknowledged

LED On – all active alarms acknowledged

LED Off – alarms inactive

L On if the local set point is being used – see *Section 4.2 in Programming Guide*.

R On if the remote set point is being used – see *Section 4.2 in Programming Guide*.

(Both L and R off if dual set point or dual fixed set points are used – see *Section 4.2 in Programming Guide*).

ST On while the self-tune procedure is being performed (flashes when procedure is complete) – see *Section 6.2*.

M On when the instrument is in Manual control mode.

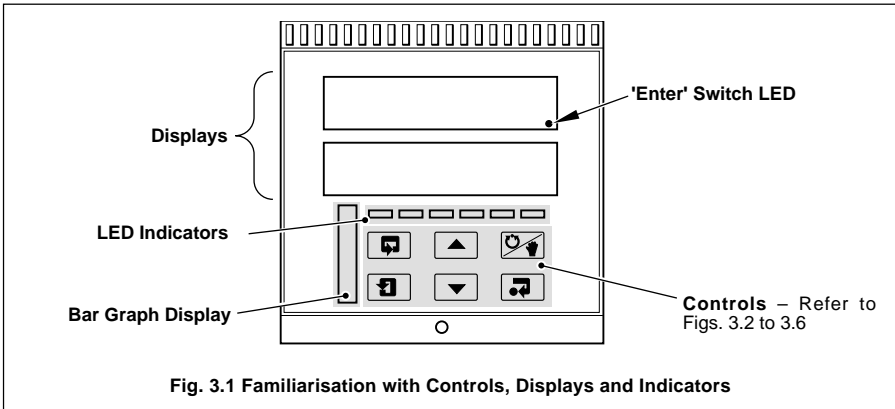

3.3 Use of Controls – Fig. 3.2 to 3.6

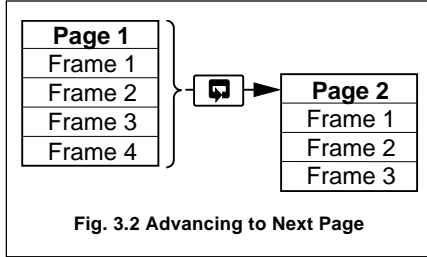

Fig. 3.2 Advancing to Next Page

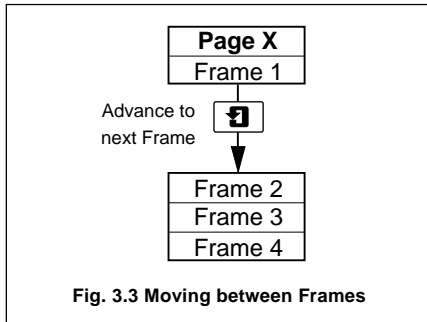

Fig. 3.3 Moving between Frames

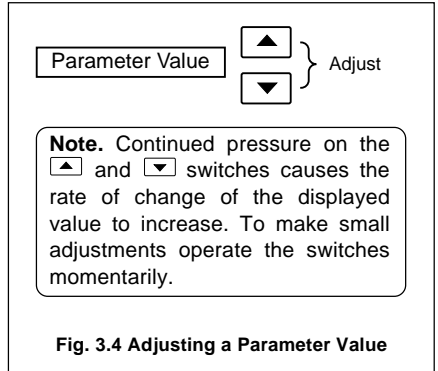

Fig. 3.4 Adjusting a Parameter Value

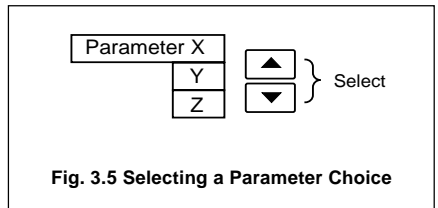



Fig. 3.5 Selecting a Parameter Choice



Used for selecting Automatic or Manual mode on alternate operations. When Manual mode is selected the displays revert automatically to the process variable values and control output or valve position (if position-proportioning or boundless motorized valve control is selected at **Control Type** frame in the **Set Up Control Page**) – See *Section 4.10 in the Programming Guide*.

Fig. 3.6 Auto/Manual Switch Functions

Information. The instrument has dedicated Operating Pages. These pages are used for general monitoring of the process measurements and are not affected by the security system which inhibits access to the programming and control pages only – see Section 5.5.

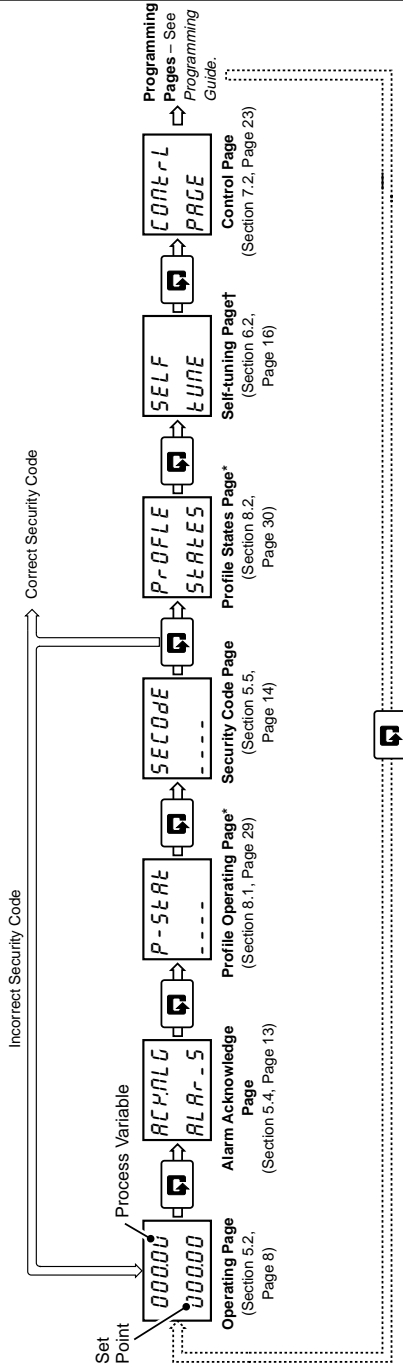

*Page hidden if Profile Function is 'OFF'

†Page hidden if Profile Function is 'ON' or 'Boundless' control is selected

Fig. 4.1 Summary of Operating Levels

5 OPERATING LEVEL

5.1 Operating Page Introduction

5.1.1 Set Point Tracking

With **set point tracking** enabled (in the **Set Points Page**), the Local set point value tracks the process variable when the controller is in Manual control mode. In this mode of operation the set point limits do not apply. If the set point value is outside its limits when Automatic control mode is selected, the local set point remains outside its limits and can only be adjusted in one direction, towards its limits. Once inside the limits they apply as normal.

With **remote set point tracking** enabled, the Local set point tracks the remote set point value when in the remote set point mode. In this mode of operation the Local set point limits do not apply. If the set point value is outside its limits when the Local set point value is selected, the Local set point remains outside its limits and can only be adjusted in one direction, towards its limits. Once inside the limits they apply as normal.

5.1.2 Auto/Manual Transfer

All auto-to-manual transfers are bumpless. If the Local set point is used and set point tracking is enabled, all manual-to-auto transfers are bumpless, since the set point is always at the same value as the process variable. Without set point tracking enabled, the response following a manual-to-auto transfer depends on the control settings. With an integral action setting the output is ramped up or down to remove any process variable offset from the set point (providing the process variable is within the proportional band). If the integral action is off, the output may step to a new value when the controller is transferred back to Automatic control mode.

With remote set point tracking enabled, the control set point switches automatically from Remote to Local when Manual mode is selected.

5.1.3 Heat/Cool Control – Fig. 6.3

When in Automatic control mode both the heat and cool outputs are turned off when in the Output Off Hysteresis Band. In Manual control mode the Output Off Hysteresis Band has no effect. If the PID output is within the Off Hysteresis Band when the controller is returned to auto control mode, the Off Hysteresis Band has no effect until either the PID output goes outside the band or becomes equal to the Crossover Value.

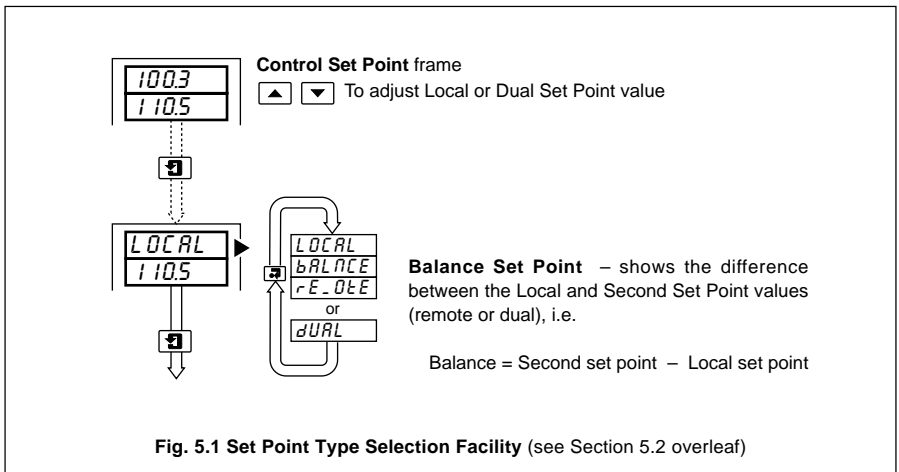

5.2 Operating Page Displays

5.2.1 Time Proportioning and Analog Control

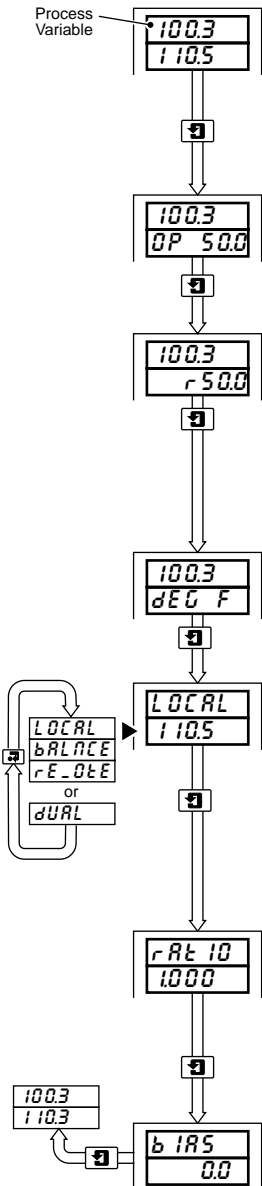

Control Set Point

The set point in use is displayed (Local, Remote or Dual). If the Local or Dual set point is displayed it can be adjusted using the and switches, providing **Set Point Adjust Enable** is set to *YES* – see *Section 4.2 of the Programming Guide, Set Points Page*.

Control Output Value (0 to 100%).

To adjust the output value manually: select Manual control mode using the switch ('M' i.e.d. is illuminated) and then use the and switches to set the required value

Manual Reset (0 to 100%).

This frame is not displayed if an **Integral Action Time** is set or **Manual Reset Adjust Enable** is set to *OFF* – see *Section 7.2, Control Page*.

Use the and switches to set a value which eliminates any offset from the set point.

Temperature Units

This frame is not displayed if the **Display Units** parameter is set to *NONE* – see *Section 4.8 of the Programming Guide Set Up Display Page*.

Set Point Type Selection – Fig. 5.1 (previous page)

Use the switch to view the various set point values. If the difference is too great, press the switch and return to the **Control Set Point** frame and adjust the Local set point to obtain an acceptable difference. The Local set point tracks the Remote set point when the Remote set point is selected, providing **Remote Set Point Tracking Enable** is set to *YES* – see *Section 4.2 of the Programming Guide, Set Points Page*.

Remote Set Point Ratio

The remote set point input (in engineering units) is multiplied by the ratio to obtain the control set point value, i.e.

Remote Set Point Value = Input x Ratio + Bias
Use the and the switches to set the ratio required, between 0.010 and 9.999 in 0.001 increments

Remote Set Point Bias

The bias value is added to the remote set point value (see previous frame) Use the and the switches to set the bias required. The bias can be set to either a positive or negative value (in engineering units).

5.2.2 Motorized Valve Control

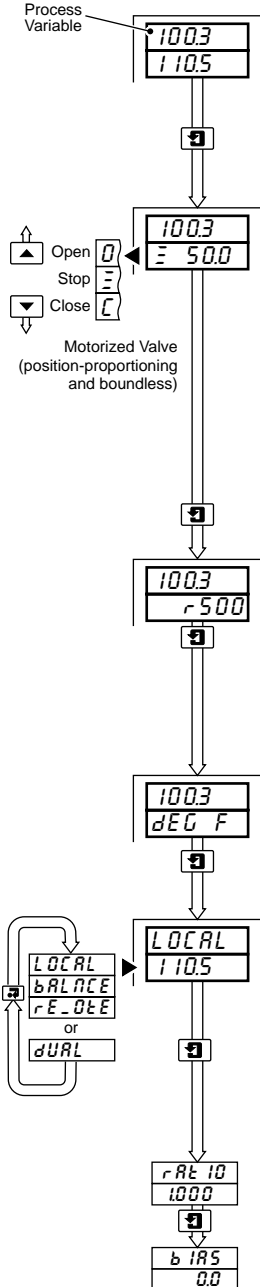

Control Set Point

The set point in use is displayed (Local, Remote or Dual). If the Local or Dual set point is displayed it can be adjusted using the and switches, providing **Set Point Adjust Enable** is set to *YES* – see *Section 4.2 of the Programming Guide, Set Points Page* .

Valve Status and Valve Position (%)

- valve stopped
- valve opening
- valve closing

The valve position is displayed as a percentage of its full travel position (not displayed on boundless controllers with position indication disabled). To adjust the valve position manually: select Manual control mode using the switch ('M' i.e.d. is illuminated) and then use the and switches to set valve position required (the switch opens the valve and the switch closes the valve). With neither switch pressed the valve is stopped.

Manual Reset (0 to 100%).

This frame is not displayed if an **Integral Action Time** is set or **Manual Reset Adjust Enable** is set to *OFF* – see *Section 7.2, Control Page* .

Use the and switches to set a value which eliminates any offset from the set point.

Temperature Units

This frame is not displayed if the **Display Units** parameter is set to *NONE* – see *Section 4.8 of the Programming Guide Set Up Display Page* .

Set Point Type Selection – Fig. 5.1 (previous page)

Use the switch to view the various set point values. If the difference is too great, press the switch and return to the **Control Set Point** frame and adjust the Local set point to obtain an acceptable difference. The Local set point tracks the Remote set point when the Remote set point is selected, providing **Remote Set Point Tracking Enable** is set to *YES* – see *Section 4.2 of the Programming Guide, Set Points Page* .

For **Remote Set Point Ratio** and **Remote Set Point Bias** settings, refer to opposite page.

5.2.3 Heat/Cool Control

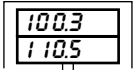

Control Set Point

The set point in use is displayed (Local, Remote or Dual). If the Local or Dual set point is displayed it can be adjusted using the and switches, providing **Set Point Adjust Enable** is set to *YES* – see *Section 4.2 of the Programming Guide, Set Points Page* .

Percentage Output (Heat, Cool and PID)

To adjust the output value manually: select Manual control mode using the switch ('M' l.e.d. is illuminated) and then use the and switches to set the value required (between 0 and 100%).

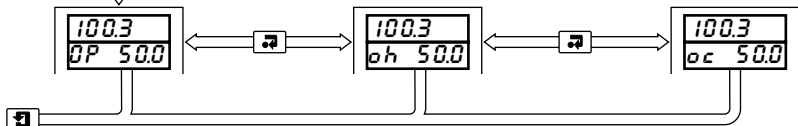

PID Output

Heat Output

Cool Output

This frame is not displayed if the P.I.D. output is **below** the **Crossover Value**.

This frame is not displayed if the P.I.D. output is **above** the **Crossover Value**.

Manual Reset, Heat and Cool (0 to 100%).

This frame is not displayed if an **Integral Action Time** is set or **Manual Reset Adjust Enable** is set to *OFF* – see *Section 7.2, Control Page*.

Use the and switches to set a value which eliminates any offset from the set point.

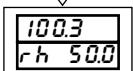

Manual Reset (Heat)

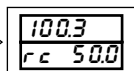

Manual Reset (Cool)

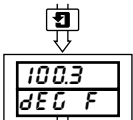

Temperature Units

This frame is not displayed if the **Display Units** parameter is set to *NONE* – see *Section 4.8 of the Programming Guide Set Up Display Page*.



For **Set Point Type Selection**, **Remote Set Point Ratio** and **Remote Set Point Bias** settings, refer to page 8.

5.3 Operating Page Messages







Message	Reason
	Line Failed – indicates power failure.
	Self-tune Fail – Self-tune procedure has failed.
	Self-tune Caution – process complete, but values may not be correct.
	Failed Input – process variable input failure.
	Failed Remote Set Point Input – flashes in lower display when remote set point input exceeds its fault detection level.
	Failed Position Feedback Input – flashes in lower display when position feedback exceeds its fault detection level.
	Failed Linearizer Range – flashes in upper display when lineariser range set exceeds that allowed for the input linearizer selected.
	High Process Alarm – flashes when a high process alarm condition is present and unacknowledged.
	Low Process Alarm – flashes when a low process alarm condition is present and unacknowledged.
	High Deviation Alarm – flashes when a high deviation alarm condition is present and unacknowledged.
	Low Deviation Alarm – flashes when a low deviation alarm condition is present and unacknowledged.

Table 5.1A Input Error Messages Displayed in the Operating Page

...5.3 Operating Page Messages

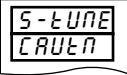
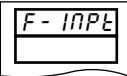
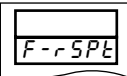
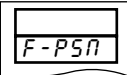
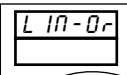



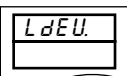

Message	Reason
	<p>High Output Alarm – flashes when a high output alarm condition is present and unacknowledged.</p>
	<p>Low Output Alarm – flashes when a low output alarm condition is present and unacknowledged.</p>
	<p>Fast Rate Alarm – flashes when a fast rate alarm condition is present and unacknowledged.</p>
	<p>Slow Rate Alarm – flashes when a slow rate alarm condition is present and unacknowledged.</p>
	<p>Mode Alarm – flashes when a mode alarm condition is present and unacknowledged.</p>
	<p>Program Event Alarm – flashes when a program event alarm condition is present and unacknowledged.</p>
	<p>Segment Event Alarm – flashes when a segment event alarm</p>

Table 5.1B Input Error Messages Displayed in the Operating Page

5.4 Alarm Acknowledge Page

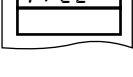
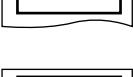

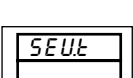
Page Header – **Acknowledge Alarms**

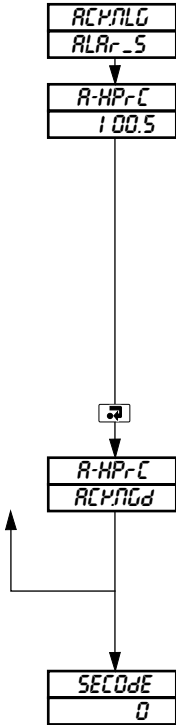
Upper Display: shows the alarm identity and type when an alarm condition is present.

For example the displays for alarm A are:

- R-HP-C – high process
- R-LP-C – low process
- R-HdEU. – high deviation
- R-LdEU. – low deviation
- R-HOUt – high output
- R-LOUt – low output
- R-F.r tE – fast rate of change of process variable*
- R-S.r tE – slow rate of change of process variable*
- R- .DdE – mode

Lower Display: shows the trip level of the alarm identified in the upper display. When the alarm is acknowledged ( pressed), ACKNGD is displayed.

*Rate of change alarms have trip levels expressed in % of span per hour.

Return to top of page or advance to **Security Code Page** or **Profile Operating Page**.

5.4.1 Mode Alarm Trips











Message	Description	Message	Description
	In Automatic Control Mode		Process Variable Input Failure
	In Manual Control Mode		Remote Set Point Input Failure
	In Local Set Point Mode		Position Feedback Input Failure
	In Remote Set Point Mode		Any Input Failure
	In Dual Set Point Mode		Profile in Hold State

Table 5.2 Alarm Types/Mode Trip Values

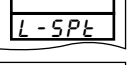
5.5 Access to Configuration Levels

A security system is used to prevent tampering with the program parameters by utilizing a Tune password and a Configuration password.

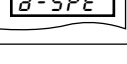

The **Tune** password gives access to the self-tune and control pages.

The **Configuration** password gives access to all controller settings and programming pages – see *Section 4.15 of the Programming Guide*.

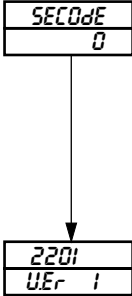
5.5.1 Security Code Page



Page Header – **Security Code Page**

Set the security code to the correct Tune or Configuration password using the  and  switches and press the  switch to enter the code.

The passwords are programmed in the **Access Page** – Refer to *Section 4.15 of the Programming Guide*.

Software version

The Upper display indicates the EPROM series.

2201 is displayed for the standard C300 EPROM, 2202 for the standard C301 EPROM, 2203 for the standard C302 EPROM and 2101 for the standard C310 EPROM. The lower display indicates the version number.

6 TUNING LEVEL

6.1 Introduction to Self-tuning

Information.

- On demand user-activated tuning.
- Two types of self-tuning – initial '**Start-up**' and when close to '**Set Point**'.
- Tuning for P, PI or PID control can be selected.
- Tuning for $1/4$ wave damped or minimum overshoot (start-up tuning only) can be selected.
- Error and Caution messages – indicate reason for tuning problems.
- Self-tune facility – not available on Heat/Cool Control and Boundless.

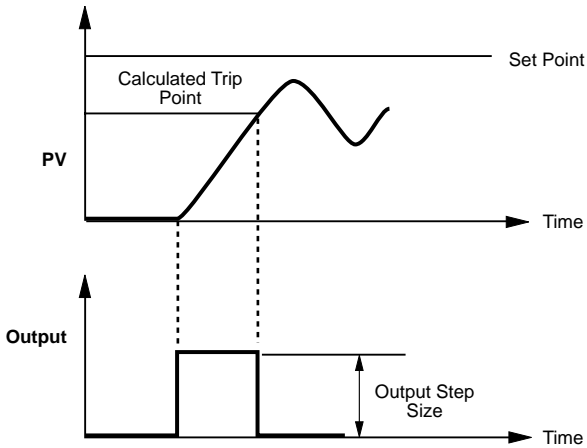

Information. The noise level of the process is monitored and then a step is applied to the control output value. The response of the process is recorded and these results are used to calculate the control terms.

Fig. 6.1 'Start Up' Self-tuning

...6.1 Introduction to Self-tuning

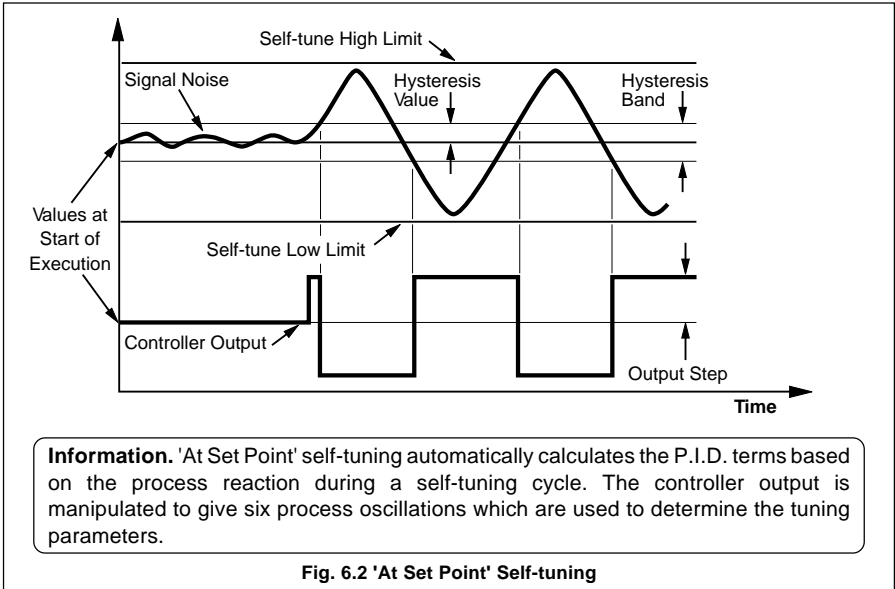

Information.
 On initial conditions:

- **'Start-up' Tuning** – the controller is placed in the Manual control mode with the control output value set to give a stable process variable at least 10% of the engineering range below the control set point.
- **'At Set Point' Tuning** – may be initialized in the automatic mode but the process variable must be close to the required set point and stable. The control output must also be stable. However, for best results the Manual control mode can be used to stabilize the output and the process value. The output must be adjusted slowly to allow process response to the change, to bring the process variable to the required control set point. The closer the process is to the set point, the more effective the self-tuning cycle.

6.2 Self-tuning Page

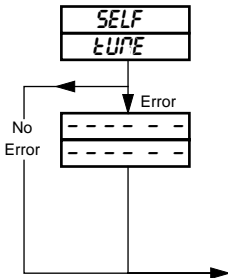

Page Header – **Self-tune.**

Note. This page is not displayed if the Profile Function is 'ON' or Control Type is set to 'b7dL55'

Error and Diagnostic Messages

If there are errors during self-tune, flashing error and diagnostic messages are displayed. To clear message, press the  switch – see Table 6.1.

Continued on next page

...6.2 Self-tuning Page

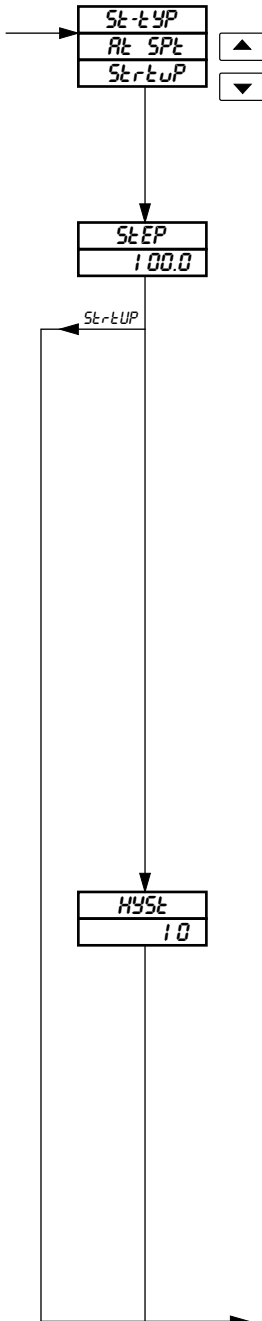
**Self tune Type**

Select the Self-tune type required:

- At SPt* (At Set Point) use when the process is close to the required set point.
- St-rtUP* (Start-up) use for self-tune from initial start-up, or for self-tune when there is a large change in set point value.

Output Step Size

The output step size is a percentage of the control output.

'Start-up' Tuning – the larger the step size used the quicker the self-tuning process is performed, but the greater the overshoot (above the calculated trip point). If too small a step size is used, the response may be too slow for the self-tuning to operate correctly. In practice, use as large a step size as can be tolerated up to a maximum of 100%.

'At Set Point' Tuning – the controller output changes by plus and minus the output step size from its initial starting value when self-tuning is executed. If the output step size is too large to allow this its value is reduced. Maximum is 50%.

Example – If the controller output value = 30% and the selected step size = 50%. The step size is reduced to 30%.

The step size should be large enough so that the amplitude of the process variable excursions are at least four times larger than the hysteresis parameter to allow the best possible response data. The output step size must be small enough to avoid the process variable crossing either of the self-tune limits (see following frames).

Hysteresis Value

The hysteresis value is entered in engineering units and is used to determine when to change the controller output value.

'At Set Point' Tuning only – when the process variable crosses the hysteresis band (plus and minus the hysteresis value), the controller output changes by plus and minus the *StEP* value from its initial starting value. The hysteresis value should be set as small as possible but larger than the noise in the process variable signal, to allow the best possible response data.

Set the hysteresis value required (in engineering units).

Continued on next page

...6.2 Self-tuning Page

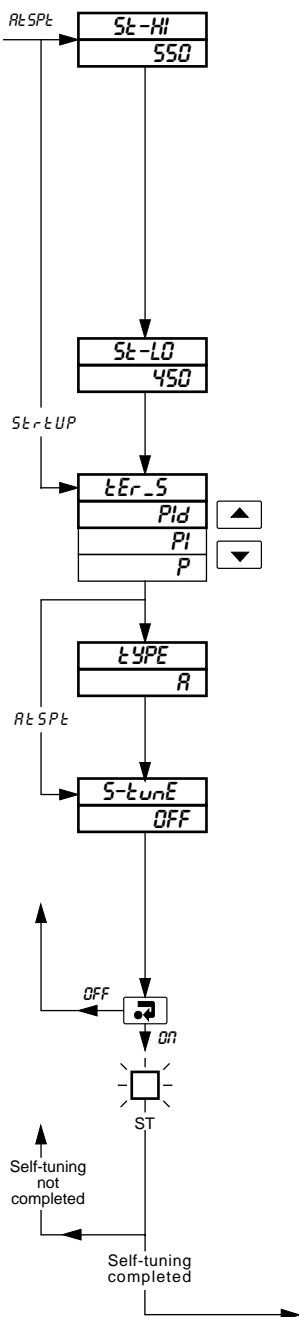

Self-tune High Limit

The process variable must be between the high and low limits during the self-tuning process. If the process value exceeds one of these, the self-tuning process is shut off automatically by reverting to the Manual control mode and returning the controller output to the value set when the self-tuning was carried out. The high and low values are the limits for cancelling self-tune execution.

Set the value required (in engineering units), the decimal point is set automatically.

Self-tune Low Limit

If the process variable value exceeds this adjustable limit during the self-tuning process, the self-tuning process is stopped automatically. The display is in engineering units.

Control Terms

Select the Proportional, Integral and Derivative terms required.

Control Type

R for quickest response with 1/4 wave damping.
or
b for quickest response with minimum overshoot.

Self-tune Mode Selection

With the self-tune mode enabled the 'ST' I.e.d. is illuminated while the controller calculates the control terms, selected above. On completion of the self-tune sequence the 'ST' I.e.d. flashes. Select *ON* to enable, *OFF* to disable.

The time taken for completion of self-tuning is dependent on the speed of response of the process being controlled.

If Self-tune is *OFF* return to the top of the **Self-tune Page**.

Wait for the 'ST' I.e.d. to flash.

Other pages can be accessed while the controller carries out the self-tune sequence. The sequence is automatically disabled on completion or can be manually disabled at any time, i.e. by selecting *OFF*.

Advance to next parameter (view advisory values) or, if self-tuning process not completed, return to top of **Self-tune Page**.

Continued on next page.

...6.2 Self-tuning Page

**Advisory Proportional Band**

Advisory value displayed (cannot be changed).

Advisory Integral Action Time

Advisory value displayed (cannot be changed).

Advisory Derivative Action Time

Advisory value displayed (cannot be changed).

Acceptance/Rejection of Advisory Values

Before accepting or rejecting the calculated values, alternative control combinations can be viewed without repeating the Self-tune process.

- To view alternative control combinations, return to the **Control terms** and **Control type** (if applicable) frames and set to the required alternative settings.
- Set the **Self-tune Mode** to ON. It reverts automatically to OFF to indicate that the new advisory values have been calculated.
- View the re-calculated advisory values.

Select:

YES to accept the advisory values. The values automatically replace those in the **Control Page** – see Section 7.2.

NO to reject the advisory values and retain those set in the **Control Page**.

Return to top of **Self-Tune Page**.

or

Advance to **Control Page**.

6.3 Self-tune Diagnostic Messages

Message	Explanation	Action
	<p>The self-tune process has selected a proportional band or integral action time above the high limits of these parameters so the high limit has been used.</p> <p>With 'Start-up' tuning, although the control set point was >10% of the display range above the process variable, it may still be too close to allow the self-tune facility to determine the process characteristics accurately.</p> <p>With 'At Set Point' tuning, the ratio of process oscillation to hysteresis value is too small for best results.</p>	<p>Because of the process characteristics, re-trying the self-tuning process is unlikely to improve the calculated control parameters.</p> <p>If desired, allow the process variable to move further below the control set point (by changing the control output in the manual control mode) before re-trying 'Start-up' self-tuning. Alternatively, use the 'At Set Point' self-tune facility.</p> <p>Restart self-tune with a larger output step size or a smaller hysteresis value. Hysteresis must be at least equal to and preferably greater than process noise.</p>
	<p>The process is too slow for the self-tuning to work correctly.</p> <p>The process variable signal is excessively 'noisy'.</p> <p>With 'Start-up' tuning, the process variable is <10% of the display range, below the control set point.</p> <p>The input failure level has been exceeded, possibly due to a broken sensors or the process has exceeded one of the self-tune limits.</p>	<p>If possible, use a larger output step value.</p> <p>Check input wiring to try and find the source of the problem. If the process is changing rapidly then allow it to settle before re-trying the self-tuning process.</p> <p>Allow the process variable to move further below the control set point before re-trying the 'Start-up' self-tuning facility. Alternatively, use the 'At Set Point' self-tune facility.</p> <p>Check input wiring to find the cause of the failure or restart self-tuning with a smaller output step size.</p>

Table 6.1 Self-tune Error/Diagnostic Messages

7 CONTROL LEVEL

7.1 Introduction to Standard Control

Information.

- On/Off Control – use for applications where precise control is not required, or where frequent switching of a contactor using time proportioning control causes premature wear.
- Proportional Control – use where:
 - cycling action of on/off control is unacceptable,
 - load changes are small or infrequent,
 - offset can be tolerated or eliminated using manual reset.
- Integral Action – introduce to the control system:
 - to eliminate offset automatically,
 - if set point or load changes frequently.
- Derivative Action – introduce to the control system:
 - to enable faster approach to the set point (by enabling use of a smaller proportional band),
 - to minimize overshoot.

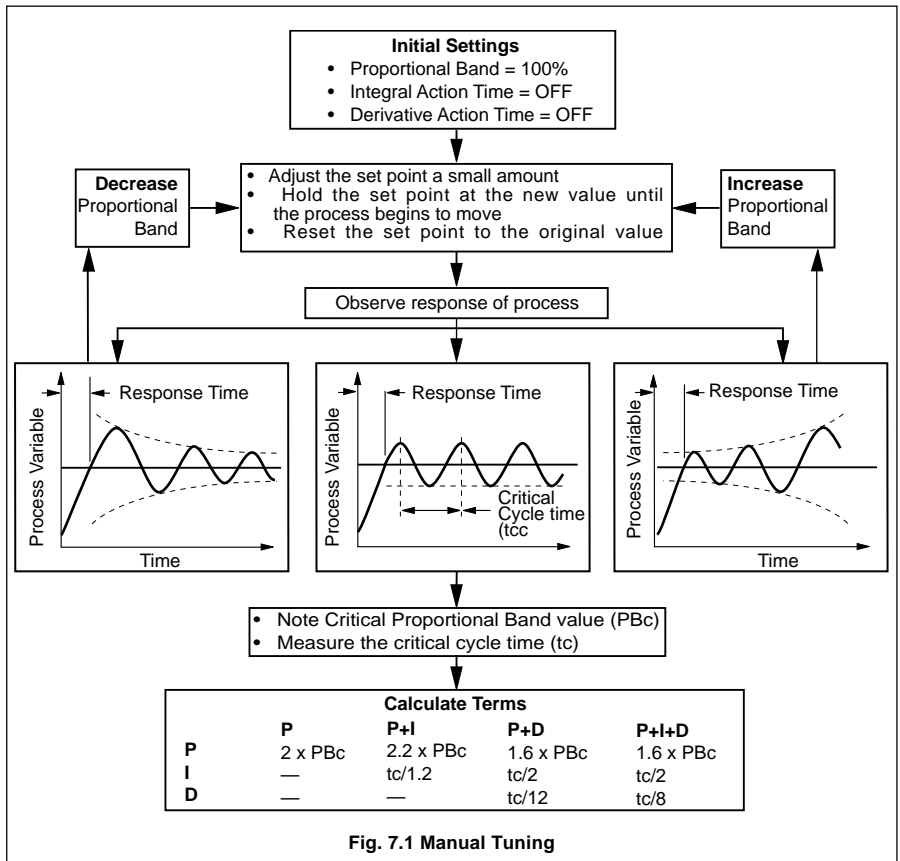

Fig. 7.1 Manual Tuning

...7.1 Introduction to Standard Control





Response	Contributions	Effect Of Response Settings		
		Too High	Too Low	
On/Off Hysteresis	Helps to prevent rapid switching of output	Process swings too far above and below set point	Output switches too rapidly	<p>Hysteresis too high</p>  <p>Hysteresis too Low</p> 
Proportional Band	Stable control with the minimum offset and minimum period of oscillation consistent with stability.	<ul style="list-style-type: none"> • More stable • Longer period • Larger offset 	Stability decreases	<p>High Prop. Band</p>  <p>1/4 Decay</p>  <p>Low Prop. Band</p> 
Integral	Eliminates offset between Process and Set Point.	Time for variable to return to set point increases	<ul style="list-style-type: none"> • Stability decreases • Period of oscillation increases 	<p>Integral Action too High</p>  <p>Correct Integral Action Time</p>  <p>Integral Action Time too Low</p> 
Derivative	<p>Increases stability, permitting smaller proportional band and larger integral action times to be used.</p> <p>Reduces height of first peak.</p> <p>Reduces period of oscillation.</p>	<ul style="list-style-type: none"> • Stability decreases • Process noise is amplified 	Maximum contribution not realized	<p>Derivative Action Time too Low</p>  <p>Derivative Action Time Correct</p>  <p>Derivative Action Time too High</p> 

Fig. 7.2 Effect of Control Responses on Processes

7.2 Control Page

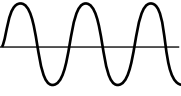

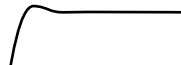
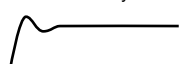
Page Header – **Control Page.**

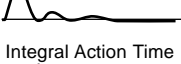
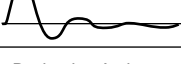
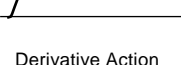
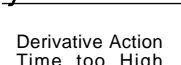
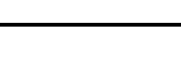
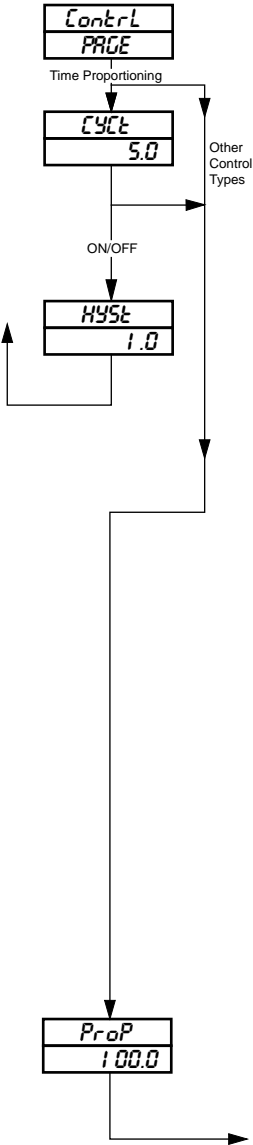
If **Heat/Cool Control** is selected, refer to Section 7.3.

Cycle Time

This frame appears only if the **Time Proportioning** function is selected in the **Set Up Control Page**. Set the required cycle time between 1.0 and 300 in 0.1 second increments, or if 'ON/OFF' mode is required, select cycle time below 1.0 second.

Hysteresis

This frame appears only if ON/OFF is selected in **Cycle Time**. The output turns off at the set point value but does not turn on again until it has moved into the safe region by an amount equal to the hysteresis value. This is only applicable to 'ON/OFF' control. Set the required hysteresis between 0.0% and 5.0% of the engineering span. The display is in engineering units.

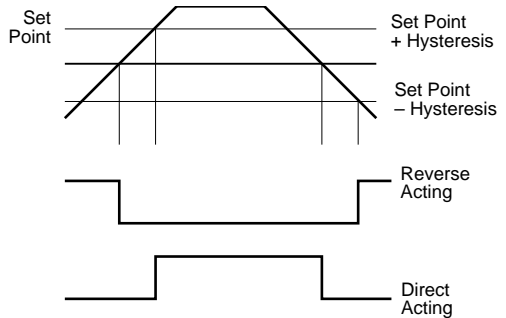

Information. Hysteresis is used with ON/OFF control to give acceptable control without causing the output to switch too rapidly.

Proportional Band

Set the proportional band value required, between 0.1 and 999.9% in 0.1% increments.

Continued on next page.

...7.2 Control Page

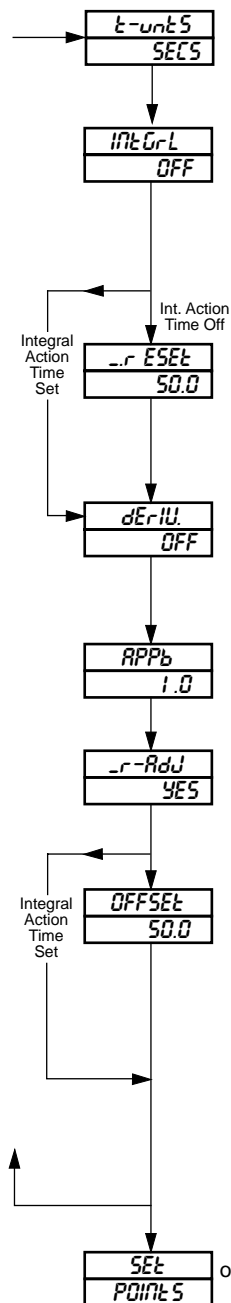

Time Units

Time units for the integral and derivative action times (see below) can be set to minutes *MIN* or seconds *SECS*.

Integral Action Time

Set the required time between 1 and 7200 in 1 second increments (0.1 and 120 minutes in 0.1 minute increments). *OFF* is displayed in place of 7201 (120.1)

Note. An **Integral Action Time** must be set when the **Control Type** is set to *bnDLSS*.

Manual Reset

Manual reset is only operable with **Integral Action Time** set to *OFF*. Set the required proportional band offset between 0.0 and 100.0% of the display (engineering) span in 0.1% increments.

Derivative Action Time

Set the required time between 0.0 and 999.9 in 0.1 second increments (0.1 and 16.67 minutes in 0.01 minute increments). *OFF* is displayed in place of zero.

Approach Band

Set the required value between 0.1 and 3.0 in 0.1 increments. (Set 1.0 initially.)

Manual Reset Adjust Enable

This display and adjustment in the **Operating Page** can be enabled or disabled. Select *YES* to enable or *NO* to disable.

Control Algorithm Offset

This frame is only applicable if **Integral Action Time** is set, (i.e. is not set to *OFF*). Set the required offset, either 0.0 or 50.0%.

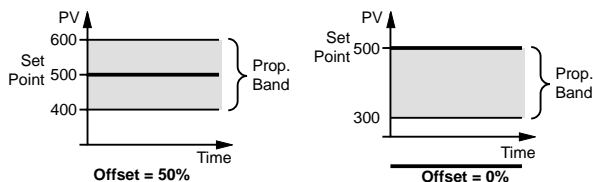

Return to the top of the **Control Page** or advance to the next page.

7.3 Introduction to Heat/Cool Control

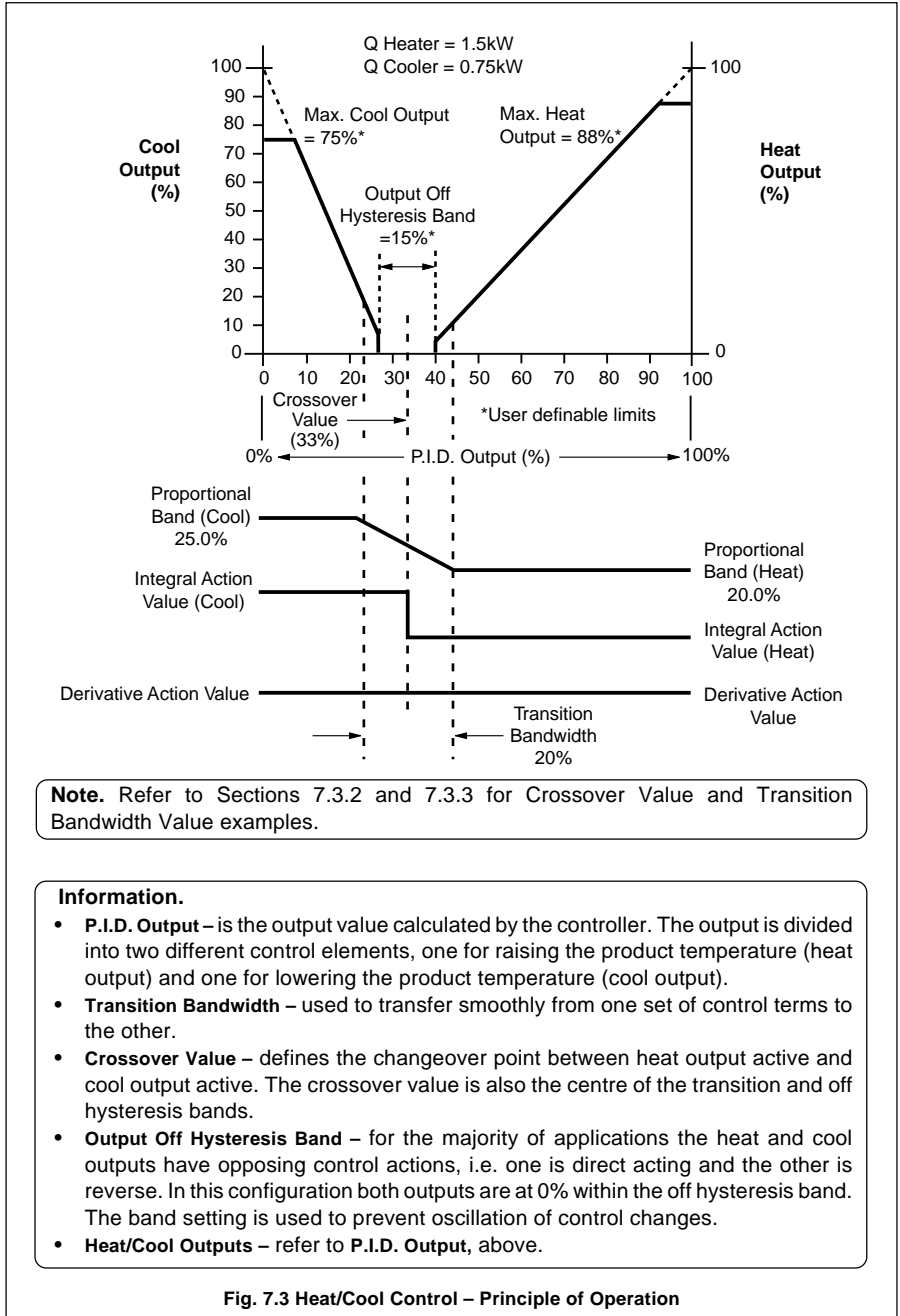
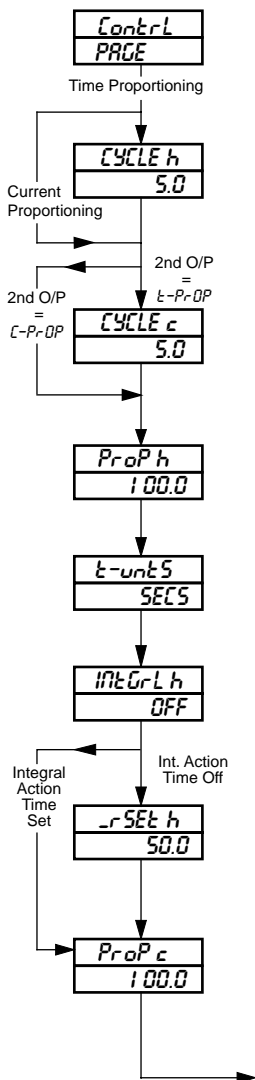

Fig. 7.3 Heat/Cool Control – Principle of Operation

7.3.1 Control Page (Heat/Cool Control)

The following parameters appear only if Heat/Cool is selected at **Control Mode** frame in the **Set Up Control Page**.



Page Header – **Control Page (Heat/Cool Control)**.

Cycle Time (Heat)

This frame appears only if **Time Proportioning Control** is selected in the **Set Up Control Page**. Set the required cycle time between 1.0 and 300 in 0.1 second increments. For **Heat/Cool Control**, 'ON/OFF' mode must not be selected.

Cycle Time (Cool)

This frame appears only when the **Second Output Type** in the **Set Up Control Page** is time proportioning. Set the required cycle time between 1.0 and 300 in 0.1 second increments.

Proportional Band (Heat)

Set the proportional band value required, between 0.1 and 999.9% in 0.1% increments.

Time Units

The time units for the integral and derivative action times (see below) can be set to minutes - *INS* or seconds *SECS*.

Integral Action Time (Heat)

Set the required time between 1 and 7200 in 1 second increments (0.1 and 120 minutes in 0.1 minute increments). *OFF* is displayed in place of 7201 (120.1).

Manual Reset (Heat)

This is only operable with Integral Action Time (Heat) set to *OFF*. Set the required proportional band offset between 0.0 and 100.0% of the display span in 0.1% increments.

Proportional Band (Cool)

Set the proportional band value required, between 0.1 and 999.9% in 0.1% increments.

Continued on next page.

...7.3.1 Control Page (Heat/Cool Control)

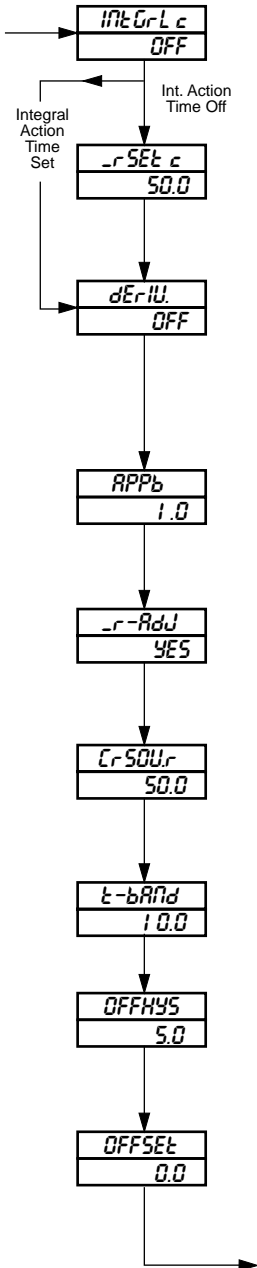
**Integral Action Time (Cool)**

Set the required time between 1 and 7200 in 1 second increments (0.1 and 120 minutes in 0.1 minute increments). *OFF* is displayed in place of 7201 (120.1).

Manual Reset (Cool)

This is only operable with Integral Action Time (Cool) set to *OFF*. Set the required proportional band offset between 0.0 and 100.0% of the display span in 0.1% increments.

Derivative Action Time

Set the required time between 0.0 and 999.9 in 0.1 second increments (0.1 and 16.67 minutes in 0.01 minute increments). The same derivative action time is used for both heating and cooling. *OFF* is displayed in place of zero.

Approach Band

Set the required value between 0.1 and 3.0 in 0.1 increments. (Set 1.0 initially.)

Manual Reset Adjust Enable

Manual Reset display and adjustment in the **Operating Page** (see Section 5.2.) can be enabled or disabled. Select *YES* to enable or no to disable.

Crossover Output Value

Set the required crossover output value, between 0.0% and 100.0% of P.I.D. output in 0.1% increments – see Section 7.3.2.

Transition Bandwidth

Set the required value, between 0.0% and 100.0% of P.I.D. output in 0.1% increments – see Section 7.3.3.

Output Off Hysteresis

The hysteresis is set to prevent oscillation of control changes. Set the required value, $\pm 25.0\%$ (of P.I.D. output) from the crossover output value, in 0.1% increments.

Control Algorithm Offset

The offset is only applicable if **Integral Action Time** is set. Set the required offset either 0.0 or 50.0%.

Continued on next page.

7.3.2 Calculating the Crossover Value – Fig 7.3

The crossover value is calculated from the expression:

$$\text{Crossover Value} = \frac{100}{\text{Gh/Gc} + 1}$$

Where Gh/Gc is the ratio of the two output driver gains.

The most common method for determining the Gh/Gc term is by using 'nameplate' values from the heat/cool device(s).

Example – if a heat/cool application can produce a maximum of 1.5kW and absorb 0.75kW:

$$\text{Output Gain Ratio} = \frac{1.5}{0.75} = 2$$

$$\text{Crossover Value} = \frac{100}{2 + 1} = 33.3\%$$

7.3.3 Calculating the Transition Bandwidth Value – Fig. 7.3

The Transition Bandwidth is the percentage difference of the proportional band settings.

Example – if the proportional band settings for the heat output is 20% and for the cool output is 25%:

$$\text{Transition Bandwidth (\%)} = \frac{25 - 20}{25} \times 100$$

$$\text{Transition Bandwidth} = 20\%$$

If the proportional band settings for both outputs are equal, the bandwidth is 0%. As a general rule, the Transition Bandwidth should not exceed 30%.

8 PROFILE OPERATION

8.1 Profile Operating Page

This only appears if the **Profile Enable** frame is set to *on* in the **Profile Program Page** – see *Section 4.1 in the Programming Guide*. Parameters displayed in this page cannot be modified.

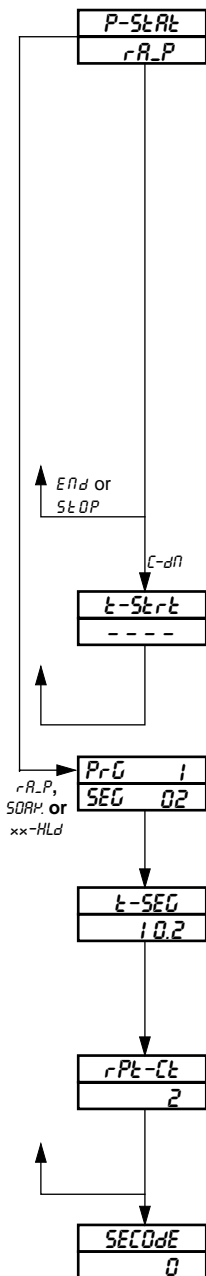

Profile Status

The current status of the selected profile is displayed:

- StOP* – Waiting for operator action
- SOAP* – Soak function, the set point is at a constant value is the current segment.
- rR_P* – Ramp function, the set point is either rising or falling in the current segment.
- C-dn* – Countdown, there is a time delay before the profile starts.
- Hb-HLd* – Holdback Hold – the profile is on Hold due to the **Holdback** feature, i.e. the measured variable has deviated beyond the hysteresis value.
- OP-HLd* – Operator Hold, the profile has been suspended by the operator.
- _n-HLd* – Manual Hold, the instrument is in Manual mode. The profile cannot run in this mode.
- End* – A profile run started from an external switch is complete and the switch is still in the Start Profile position.

Countdown Time

This is only accessed if a **Time Delay** for the profile start has been set in the **Profile States Page** – see next page. The countdown time remaining is displayed in minutes. Return to top of the **Profile Operating Page**.

Current Program and Segment

The current program and segment number is shown. The program of segments is set-up in the **Profile Program Page** – see *Section 4.1 in the Programming Guide*.

Segment Time

The time remaining before the current segment stops/next segment starts is displayed (0 to 999.9 minutes). The segment time is set in the **Profile Program Page** – see *Section 4.1 in the Programming Guide*.

Program Repeat Count

The number of outstanding repeats for the current program is displayed at this parameter. The repeat number is set in the **Profile Program Page** (between 0 and 99 or continuous – *InfOnE* is displayed).

Return to top of **Profile Operating Page** or advance to the **Security Code Page**.

8.2 Profile States Page

The **Profile States Page** is only present if the **Profile Enable** frame is set to *on* in the **Profile Program Page** – see *Section 4.1 in the Programming Guide*.

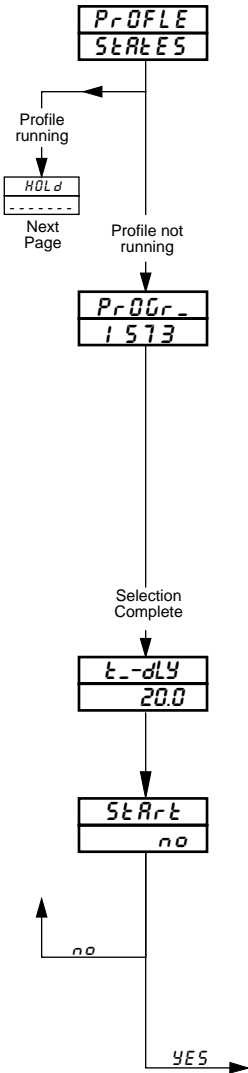

Page Header – **Profile States**.

Advance to the next parameter.

Program Select

Up to four programs can be selected. The programs are selected in the order that they are required to run. The flashing character on the lower display indicates the currently selected program and its position in the program running order.

Example – if the programs 1, 3, 5, and 7 are required to run in the order 1, 5, 7 and 3, then:

- Select 1, press the switch
- Select 5, press the switch
- Select 7, press the switch
- Select 3, press the switch

If less than four programs are required, end by selecting and storing the terminator 'E'.

Select a program, or the terminator 'E'.

Press the switch to advance to the next program in the running order (character flashing), or if the selection is complete, advance to the next parameter.

Time Delay

A countdown time may be set to provide a controlled delay before the start of the profile run.

Set the delay time from 0.0 to 999.9 minutes.

Start Profile Run

no is displayed when the profile is not running.

Press the switch to start the run. The display changes to YES.

Advance to the next parameter if the profile is running or return to top of **Profile States Page**.

Continued on next page.

...8.2 Profile States Page

From top of page 30

HOLD
H-bRCP
OPER-RL
_N-HLD
OFF

rESEt
no

Program Hold

The program may be put on hold (suspended) by any of three conditions. The lower display shows the type of hold condition or *OFF*:

H-bRCP - hysteresis action, the process variable has deviated beyond hysteresis value.

OPER-RL -  pressed or placed in hold mode by a logic input.

_N-HLD - the instrument has been switched to manual control mode.

OFF - hold function is off.

Press the  switch to change the hold state.

If a logic input has been assigned to the Start/Hold Profile function, i.e. *P-SEt* has been selected (see *Section 4.10 of the Programming Guide*), the  switch is disabled.

Reset the Profile

This frame is omitted if a logic input has been assigned to the Profile Reset function, i.e. *P-rSEt* has been selected – see *Section 4.10 of the Programming Guide*.

no is displayed on entry to this parameter. When the  switch is pressed to reset the profile the display changes to *YES* then reverts to *no*. If the profile is reset and a hold condition does not exist (see next parameter) the profile returns to the beginning of the program and continues to run. If in a hold condition the profile being performed is **stopped** and the local set point takes the value of the first level of the selected profile.

Press the  switch to reset the profile, or advance to the next parameter.

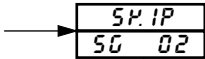

Continued on next page.

...8.2 Profile States Page



Skip Segment

This frame is omitted if a logic input has been assigned to the Skip Current Segment function, i.e. *P - SP. IP* has been selected, see *Section 4.10 in the Programming Guide*.

A segment may be skipped by pressing the  switch. When the  switch is pressed the profile immediately abandons the current segment and executes the next segment.

Normally, the Current Segment number is displayed on the lower display.

C - dn is displayed during a countdown time – see **Time Delay** which can also be skipped if required. If the segment being skipped is the last segment then *END* is displayed.

Press the  switch to skip the next segment.

Return to top of **Profile States Page** or advance to the *Programming Guide*.

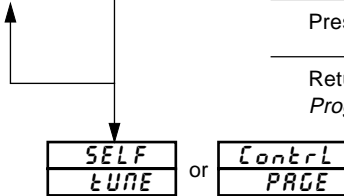

PRODUCTS & CUSTOMER SUPPORT

Products

Automation Systems

- *for the following industries:*
 - Chemical & Pharmaceutical
 - Food & Beverage
 - Manufacturing
 - Metals and Minerals
 - Oil, Gas & Petrochemical
 - Pulp and Paper

Drives and Motors

- *AC and DC Drives, AC and DC Machines, AC motors to 1kV*
- *Drive systems*
- *Force Measurement*
- *Servo Drives*

Controllers & Recorders

- *Single and Multi-loop Controllers*
- *Circular Chart , Strip Chart and Paperless Recorders*
- *Paperless Recorders*
- *Process Indicators*

Flexible Automation

- *Industrial Robots and Robot Systems*

Flow Measurement

- *Electromagnetic Flowmeters*
- *Mass Flow Meters*
- *Turbine Flowmeters*
- *Flow Elements*

Marine Systems & Turbochargers

- *Electrical Systems*
- *Marine Equipment*
- *Offshore Retrofit and Referbishment*

Process Analytics

- *Process Gas Analysis*
- *Systems Integration*

Transmitters

- *Pressure*
- *Temperature*
- *Level*
- *Interface Modules*

Valves, Actuators and Positioners

- *Control Valves*
- *Actuators*
- *Positioners*

Water, Gas & Industrial Analytics

Instrumentation

- *pH, conductivity, and dissolved oxygen transmitters and sensors*
- *ammonia, nitrate, phosphate, silica, sodium, chloride, fluoride, dissolved oxygen and hydrazine analyzers.*
- *Zirconia oxygen analyzers, katharometers, hydrogen purity and purge-gas monitors, thermal conductivity.*

Customer Support

We provide a comprehensive after sales service via a Worldwide Service Organization. Contact one of the following offices for details on your nearest Service and Repair Centre.

United Kingdom

ABB Limited
Tel: +44 (0)1480 475 321
Fax: +44 (0)1480 217 948

United States of America

ABB Inc
Tel: +1 215-674-6000
Fax: +1 215-674-7183

Client Warranty

Prior to installation, the equipment referred to in this manual must be stored in a clean, dry environment, in accordance with the Company's published specification.

Periodic checks must be made on the equipment's condition. In the event of a failure under warranty, the following documentation must be provided as substantiation:

1. A listing evidencing process operation and alarm logs at time of failure.
2. Copies of all storage, installation, operating and maintenance records relating to the alleged faulty unit.

ABB has Sales & Customer Support expertise
in over 100 countries worldwide

www.abb.com

The Company's policy is one of continuous product
improvement and the right is reserved to modify the
information contained herein without notice.

Printed in UK (06.04)

© ABB 2004



ABB Limited

Howard Road, St. Neots
Cambridgeshire, PE19 8EU
UK

Tel: +44 (0)1480 475321
Fax: +44 (0)1480 217948

ABB Inc.

125 E. County Line Road
Warminster, PA 18974
USA

Tel: +1 215 674 6000
Fax: +1 215-674 7183