

SAFETY INSTRUCTIONS

AF(C)40...80(B)-40/22, CA4, CAL4, CAT4, CC4, LDC4, RV4, RC4
Contactors AF and accessories

Doc.no.ISBC101047M6801 (03/23)

	<p>it Attenzione: Tensione pericolosa! Fare riferimento alle istruzioni per l'uso. Prima di intervenire su questo dispositivo, scollegare e isolare tutte le fonti di alimentazione. Attenzione! L'installazione deve essere eseguita esclusivamente da un installatore qualificato.</p>
<p>ar تحذير: جهد كهربائي خطير! راجع تعليمات التشغيل. افصل الكهرباء وقم بتأمينها قبل العمل في هذا الجهاز. تنبيه! يجب عدم التركيب إلا من خلال شخص على دراية بمجال التقنية الكهربائية.</p>	<p>lt Įspėjimas: Pavojinga įtampa! Žr. naudojimo instrukcijas. Atjunkite ir laikinai užblokuokite maitinimą prieš dirbdami su šiuo įrenginiu. Dėmesio! Įrengti gali tik asmuo, turintis elektrotechniko patirties.</p>
<p>bg Предупреждение: Опасно напрежение! Вижте инструкциите за работа. Изключете и блокирайте захранването преди да работите с устройството. Внимание! Да се монтира само от експерт електротехник.</p>	<p>lv Brīdinājums: Bīstams spriegums! Skatiet darba norādījumus. Pirms sākat darbu ar šo ierīci, atvienojiet un bloķējiet strāvas padevi. Uzmanību! Uzstādīšanu drīkst veikt tikai persona ar zināšanām par elektrotehniku.</p>
<p>cs Varování: Nebezpečné napětí! Viz návod k obsluze. Před zahájením prací na tomto zařízení odpojte a uzamkněte napájení. Pozor! Toto zařízení smí instalovat pouze osoba s elektrotechnickou odborností.</p>	<p>nl Waarschuwing: Gevaarlijke spanning! Raadpleeg de installatie-instructies. Koppel dit apparaat los van de stroomvoorziening voordat u werkzaamheden uitvoert. Let op! Installatie mag alleen worden uitgevoerd door een monteur met elektrotechnische expertise.</p>
<p>da Advarsel: Farlig elektrisk spænding! Se installationsinstruktioner. Frakobl enheden, og afbryd strømforsyningen, før du arbejder med denne enhed. Giv agt! Installation må kun foretages af personer med elektroteknisk ekspertise.</p>	<p>no Advarsel: Farlig spenning! Se i bruksanvisningen. Koble fra og steng av strømmen før du arbeider på denne enheten. Forsiktig! Montering skal kun utføres av kvalifiserte personer med elektrokompetanse.</p>
<p>de Warnung: Gefährliche Spannung! Siehe Installationsanleitung. Vor dem Arbeiten Gerät ausschalten und von der Spannungsversorgung trennen. Achtung! Installation nur durch elektrotechnische Fachkraft.</p>	<p>pl Ostrzeżenie: Niebezpieczne napięcie! Patrz: instrukcja instalacji. Przed rozpoczęciem wykonywania pracy z tym urządzeniem odłącz i zablokuj zasilanie. Uwaga! Montaż może wykonywać wyłącznie osoba posiadająca doświadczenie elektrotechniczne.</p>
<p>el Προειδοποίηση: Επικίνδυνη τάση! Ανατρέξτε στις οδηγίες λειτουργίας. Αποσυνδέστε και απομονώστε την παροχή ισχύος προτού ξεκινήσετε τις εργασίες σε αυτήν τη συσκευή. Προσοχή! Η εγκατάσταση πρέπει να γίνεται μόνο από αδειούχο ηλεκτρολόγο εγκαταστάτη.</p>	<p>pt Aviso: Tensão perigosa! Consulte as instruções de instalação. Desconecte e desligue a energia elétrica antes de trabalhar nesse dispositivo. Atenção! A instalação deve ser feita apenas por uma pessoa com especialidade eletrotécnica.</p>
<p>en Warning: Hazardous voltage! Refer to installation instructions. Disconnect and lock out power before working on this device. Attention! Installation by person with electrotechnical expertise only.</p>	<p>ro Avertisment: Tensiune electrică periculoasă! Consultați instrucțiunile de utilizare. Deconectați și închideți sursa de energie înainte de a lucra cu acest dispozitiv. Atenție! Instalarea trebuie realizată doar de către o persoană cu expertiză electrotehnică.</p>
<p>es Advertencia: ¡Tensión peligrosa! Consulte las instrucciones de instalación. Antes de trabajar con este dispositivo, desconecte y bloquee la corriente. ¡Atención! La instalación debe ser realizada únicamente por un técnico electricista.</p>	<p>ru Предупреждение: Опасное электрическое напряжение! Обратитесь к инструкциям по монтажу. Отключите электропитание и обеспечьте безопасность перед началом работ. Внимание! Монтаж должен выполняться только специалистом по электротехническим работам.</p>
<p>et Hoiatus: Elektrilöögi oht! Lisateavet vaadake kasutusjuhendist. Enne selle seadmega töötamist ühendage lahti ja lukustage toide. Tähelepanu! Seadet tohib paigaldada ainult elektrotehnilise kogemusega isik.</p>	<p>sk Výstraha: Nebezpečné napätie! Pozrite si návod na použitie. Pred začatím prác na tomto zariadení odpojte a zablokujte napájanie. Pozor! Inštaláciu smie vykonávať len osoba s odbornými znalosťami v oblasti elektrotechniky.</p>
<p>fi Varoitus: Vaarallinen jännite! Katso asennusohje. atkaise virta ja estä virran kytkeminen lukituksella ennen töiden aloittamista. Huomio! Asennuksen saa suorittaa vain henkilö, jolla on kokemusta sähkötekniikasta.</p>	<p>sl Opozorilo: Nevarna napetost! Glejte navodila za uporabo. Pred delom na tej napravi izklopite in zaklenite električno napajanje. Pozor! Namestitve sme izvesti samo elektrotehnični strokovnjak.</p>
<p>fr Avertissement: Tension dangereuse! Consultez les consignes d'installation. Débranchez et verrouillez l'alimentation électrique avant d'entreprendre des travaux sur cet appareil. Attention! L'installation doit être effectuée uniquement par une personne ayant une expertise en électrotechnique.</p>	<p>sv Varning: Livsfarlig spänning! Se i bruksanvisningen. Frånkoppla och blockera anläggning eller en anläggningsdel innan arbete utförs. Obs! Får endast installeras av behörig elektriker.</p>
<p>hr Upozorenje: Opasan napon! Pogledajte upute za ugradnju. Odspojite i isključite struju prije rada na ovom uređaju. Pažnja! Ugradnja je dopuštena samo osobama stručnim u području elektrotehnike.</p>	<p>tr Uyarı: Tehlikeli gerilim! Montaj talimatlarına bakın. Bu cihaz üzerinde çalışmadan önce elektriği kesin ve kilitleyin. Dikkat! Yalnızca elektroteknik uzmanlığa sahip kişiler tarafından kurulabilir.</p>
<p>hu Figyelmeztetés: Veszélyes feszültség! Lásd a használati utasítást. Válassza le és zárja ki az áramellátást, mielőtt a berendezésen dolgozni kezd. Figyelem! Az üzembe helyezés csak elektrotechnikai szakértelemmel rendelkező személy végezheti el.</p>	<p>zh 警告: 高压危险! 请参见操作手册。 操作本设备前请断开并锁定电源。 注意! 安装仅限专业电工人员。</p>

INSTALLATION INSTRUCTIONS

AF(C)40...80(B)-40/22, CA4, CAL4, CAT4, CC4, LDC4, RV4, RC4

Contactors AF and accessories

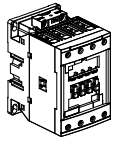

AF(C)40...52(B)-40-00
AF(C)40...52(B)-22-00

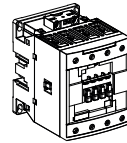
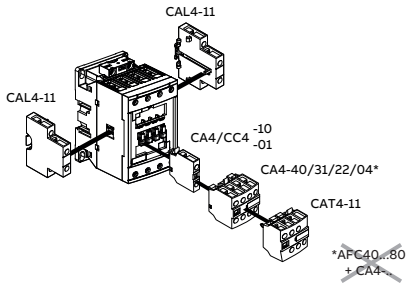

AF(C)80(B)-40-00
AF(C)80(B)-22-00

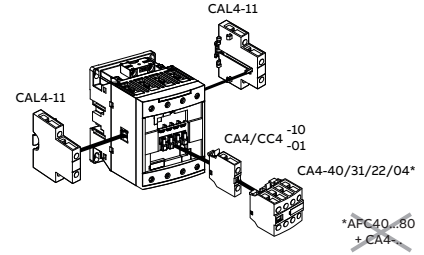

	AF(C)40...80(B)-40-00	AF(C)40...80(B)-22-00
Pos. 1, 1 ± 30°, 2, 3, 4, 5	max 8 aux contacts* / 6NC**	max 8 aux contacts* / 2NC**

⚠ CC4 : * max 1x CC4-10 + max 1x CC4-01 / CC4-01 : ** max NC-1

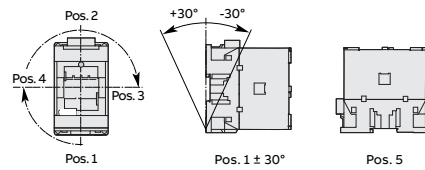

	AF(C)40...52(B)-40/22	M6 4 Nm (35 Lb.in)	Ø 6.5 mm (0.26 in)	Pozidriv N°2	Rigid Solid	Rigid Stranded				
						1 or 2 x 6...35 mm ² 1 or 2 x AWG 10-2	1 or 2 x 4...35 mm ²	1 or 2 x 4...35 mm ²	16 mm (0.63 in)	-
	AF(C)80(B)-40/22	M8 6 Nm (53 Lb.in)	-	Hexagon 4 mm		1 x 6...70 mm ² 2 x 6...50 mm ² 1 or 2 x AWG 6-1	1 or 2 x 6...50 mm ²	1 or 2 x 6...50 mm ²	17 mm (0.67 in)	-
	AF(C)40...80(B)-40/22 LDC4 RV4.../RC4...	M 3.5 1.2 Nm (11 Lb.in)	Ø 5.5 mm (0.22 in)	Pozidriv N°2		1 or 2 x 1...2.5 mm ² 1 or 2 x AWG 18-14	1 or 2 x 0.75...2.5 mm ²	1 x 0.75...2.5 mm ² 2 x 0.75...1.5 mm ²	10 mm (0.39 in)	< 8 mm (0.31 in)
	CA4-... CC4-... CAT4-... CAL4-11									

Push-in / Spring	Wiring / Unwiring							
	LDC4K							
		Wiring Push-in / Unwiring with screwdriver				1 or 2 x 1...2.5 mm ² 1 or 2 x AWG 18-14	1 or 2 x 1...1.5 mm ²	-
	CA(L)4...K							
		Wiring / Unwiring with screwdriver				1 or 2 x 0.5...2.5 mm ²	1 or 2 x 0.5...1.5 mm ²	1 or 2 x 0.5...2.5 mm ²

According to UL60947-4-1 and CSA C22.2 NO. 60947-4-1, for use on a circuit capable of delivering not more than the max. symmetrical amperes at the max. voltage shown in the table below.
WARNING : if opening of BCP, controller shall be examined and replaced if damaged.

Max short-circuit at 480 V, 600 V (kA)	AF(C)40...52(B)-40/22	AF(C)80(B)-40/22
	max Fuse 150 A/RK5	max Fuse 200 A/RK5
	5	5

Acc. to UL60947-4-1 and CSA C22.2 NO. 60947-4-1, min. enclosure for:
AF(C)40(B), AF(C)52(B): 255 x 180 x 175 mm
AF(C)80(B): 300 x 300 x 200 mm

INSTALLATION INSTRUCTIONS

AF(C)40...80(B)-40/22, CA4, CAL4, CAT4, CC4, LDC4, RV4, RC4

Contactors AF and accessories

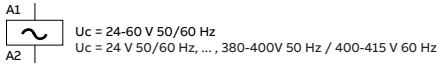
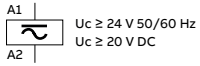

AFC40...80:
LDC4(K) feeder block can be replaced by RC4.. / RV4.. surge suppressor.
When using 2 feeder blocks, one of them can be replaced by RC4.. / RV4.. surge suppressor.

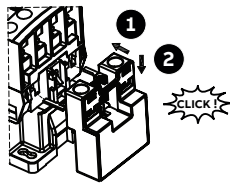

AF(C)40...80(B)

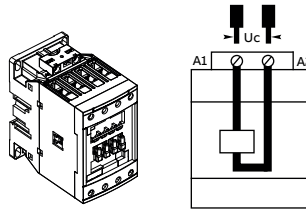

AF(C)40...80(B)

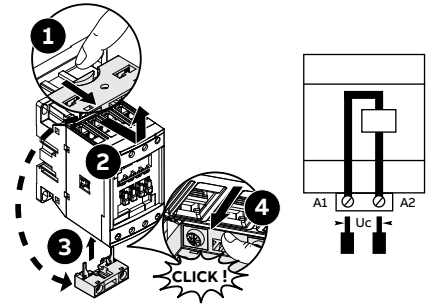

AF(C)40...80(B) + LDC4(K)

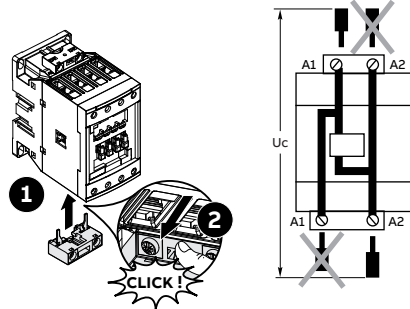

AF(C)40...80(B) + CAT4...

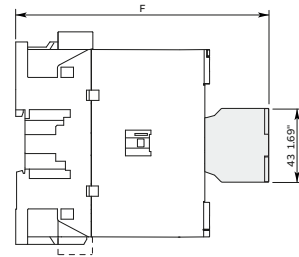
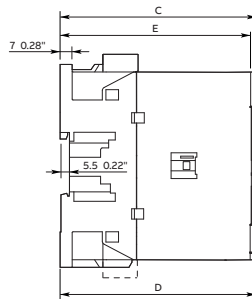
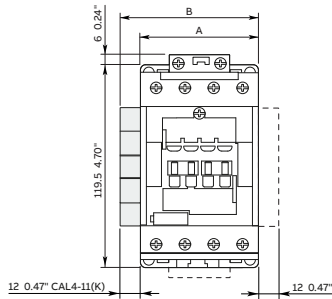
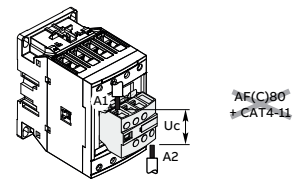

	A mm inch	B mm inch	C mm inch	D mm inch	E mm inch	F mm inch	
						CA4(K) CC4	CAT4
AF(C)40...52(B)-40-00 AF(C)40...52(B)-22-00	70 2.76"	82 3.23"	113.5 4.47"	113.5 4.47"	107.5 4.23"	147 5.79"	139 5.47"
AF(C)80(B)-40-00 AF(C)80(B)-22-00	90 3.54"	102 4.02"	116 4.57"	116 4.57"	110 4.33"	149 5.87"	-

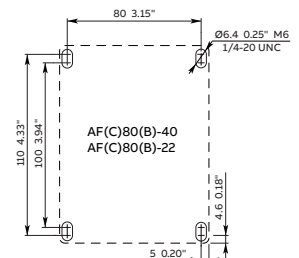
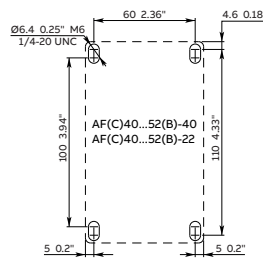
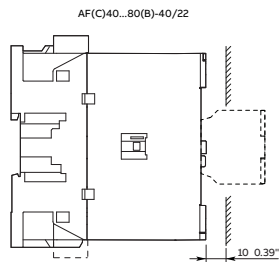
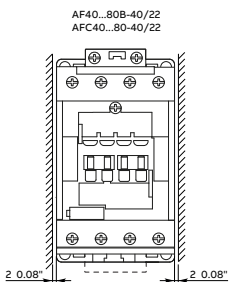

INSTALLATION INSTRUCTIONS

AF(C)40...80(B)-40/22, CA4, CAL4, CAT4, CC4, LDC4, RV4, RC4
Contactors AF and accessories

Assembly

35 x 15 mm
 EN/IEC 60715

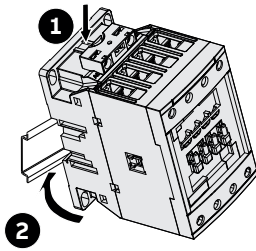

Disassembly

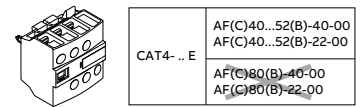
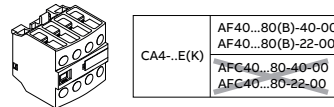
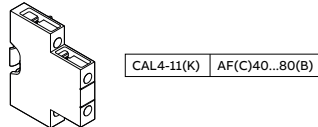
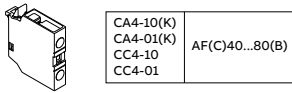
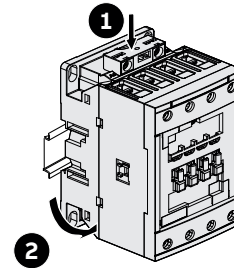

Assembly

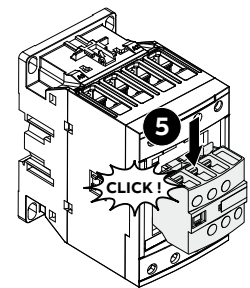
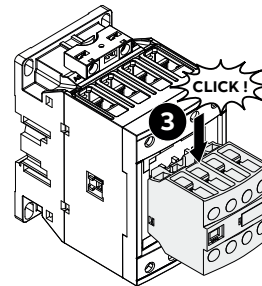
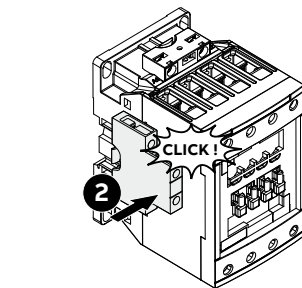
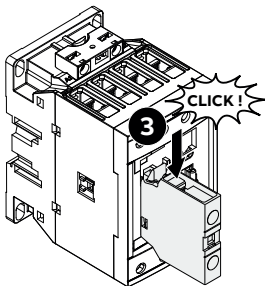
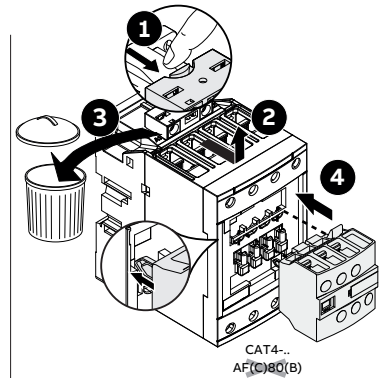
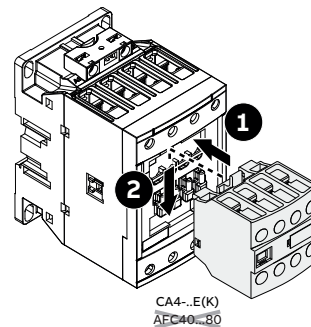
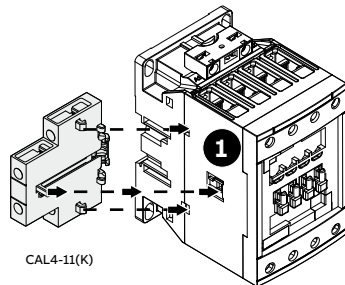
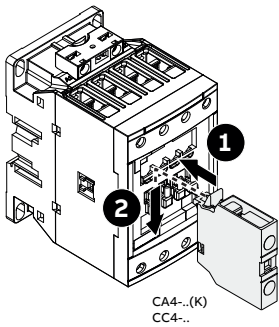

Disassembly



ABB France
 11, rue d'Arsonval
 69680 Chassieu
 France

Further information:

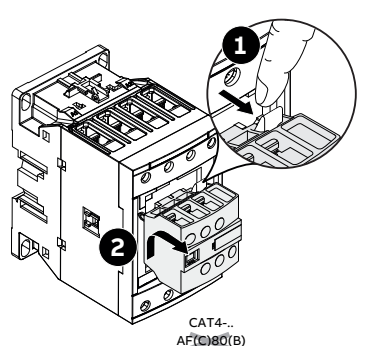
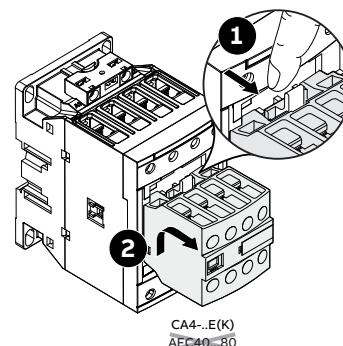
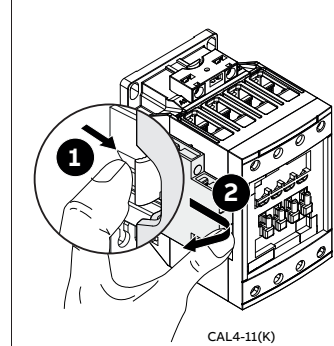
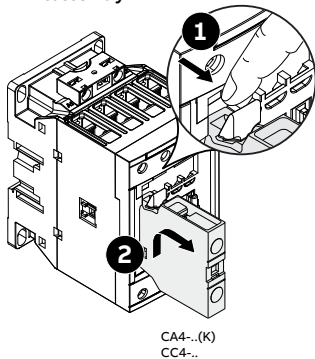

Revision
 F

Revision date
 2023-03-15

Document number
 1SBC101047M6801

© Copyright 2021 ABB.
 All rights reserved.
 Specifications subject
 to change without notice.