



---

AUGUST 2022

# R-MAG<sup>®</sup> outdoor vacuum magnetic circuit breaker

## Product overview

# R-MAG circuit breaker

## Why R-MAG breaker?

**R-MAG** is designed to provide reliability, minimize downtime, and decrease excessive maintenance

- Maintenance-free operating mechanism from the world leader in magnetic actuation technology
- Incorporates ABB world class vacuum interrupters
- Easy plug and play design of the ED2 electronic control board for rapid replacement in the field

Over 30,000 R-MAG breakers installed in more than 20 countries



# R-MAG circuit breaker

## History

- 1949: Three phase, Type GR3, oil interruption
- 1957: PR recloser/breaker, oil interruption series
- 1972: Type-R Vacuum Breaker
- 1974: ES recloser/breaker, oil/shunt, 3-phase
- 1977: ESVA Air insulated 3 Pole recloser
- 1978: ESV 3 Pole vacuum in oil recloser
- 1983: Type-V vacuum breaker
- 2002: Release of R-MAG 15kV & 27kV Magnetic actuator
- 2010: Release of R-MAG 38kV Magnetic actuator
- 2012: 40 kA interrupting rating added to 38kV R-MAG
- 2016: Release of reduced footprint 27kV R-MAG
- 2022: Release of NextGeneration NEMA3R, NEMA4 and Arc Resistant variants



---

# R-MAG circuit breaker

Three main components



## Operating mechanism

Provides reliable operation even after extended periods of inactivity



## Vacuum interrupter assembly

ABB interrupters are rated for up to 30,000 mechanical or load operations



## Electronic control board

Compatible with all forms of overcurrent, reclosing and control functions

# R-MAG circuit breaker

## Magnetic actuator

### Magnetic actuator operation

- The actuator is a bistable magnet system, where armature change-of-state is accomplished by the magnetic field of two electrically excited coils
- The armature is held magnetically in the open/close positions by the fields of two rare-earth permanent magnets
- Switching operations are achieved by excitation of one of the two coils until the retaining force of the permanent magnets is exceeded
- Only one moving part!
- No maintenance needed in magnetic actuator!

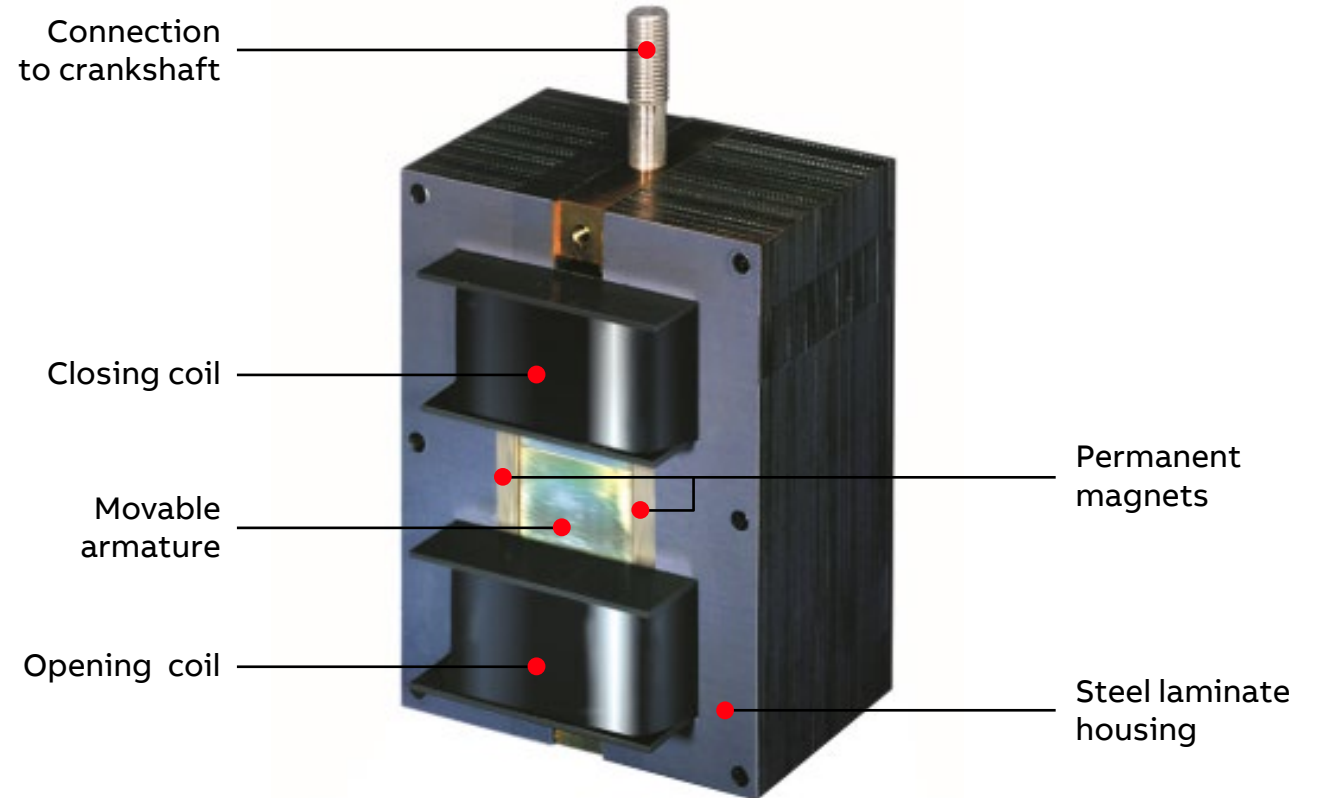

# R-MAG circuit breaker

Magnetic actuator in ABB

1. **VM1:** Indoor IEC vacuum circuit breaker
2. **AMVAC:** Indoor ANSI vacuum circuit breaker
3. **GSH II:** Indoor railway vacuum circuit breaker
4. **FXK II:** Outdoor Railway vacuum circuit breaker
5. **R-MAG:** Outdoor ANSI vacuum circuit breaker
6. **OVB-SDB:** Outdoor IEC vacuum circuit breaker

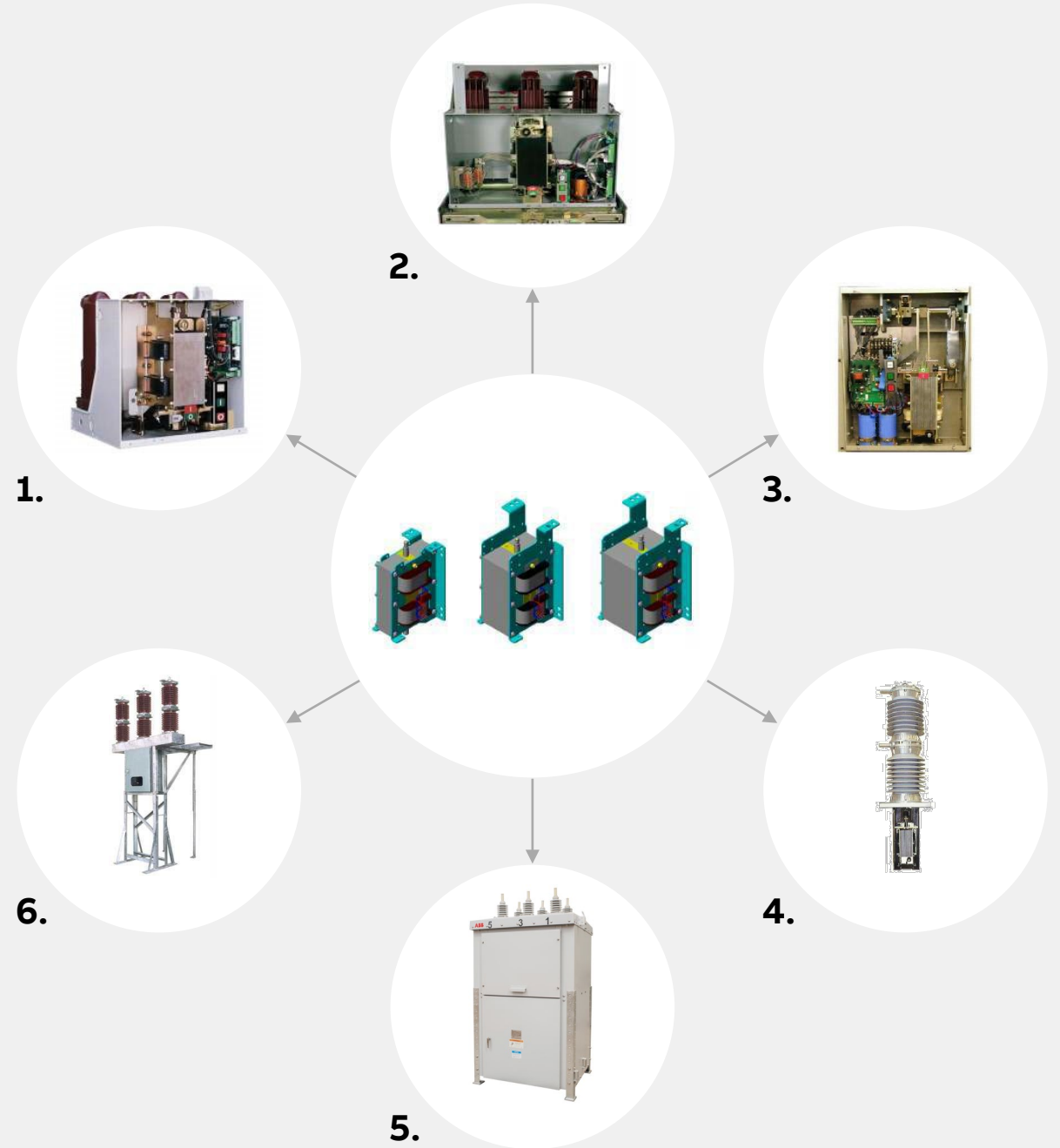

# R-MAG circuit breaker

## Magnetic actuator: life expectancy

- Developments in magnetic material technology allows the magnetic actuator to be highly reliable over long lifetime
- Reduction in magnetic flux density is less than 1% over 100 years at 248°F (120°C)
- Rated at 100,000 operations for 15 kV and 27 kV and 50,000 for 38 kV

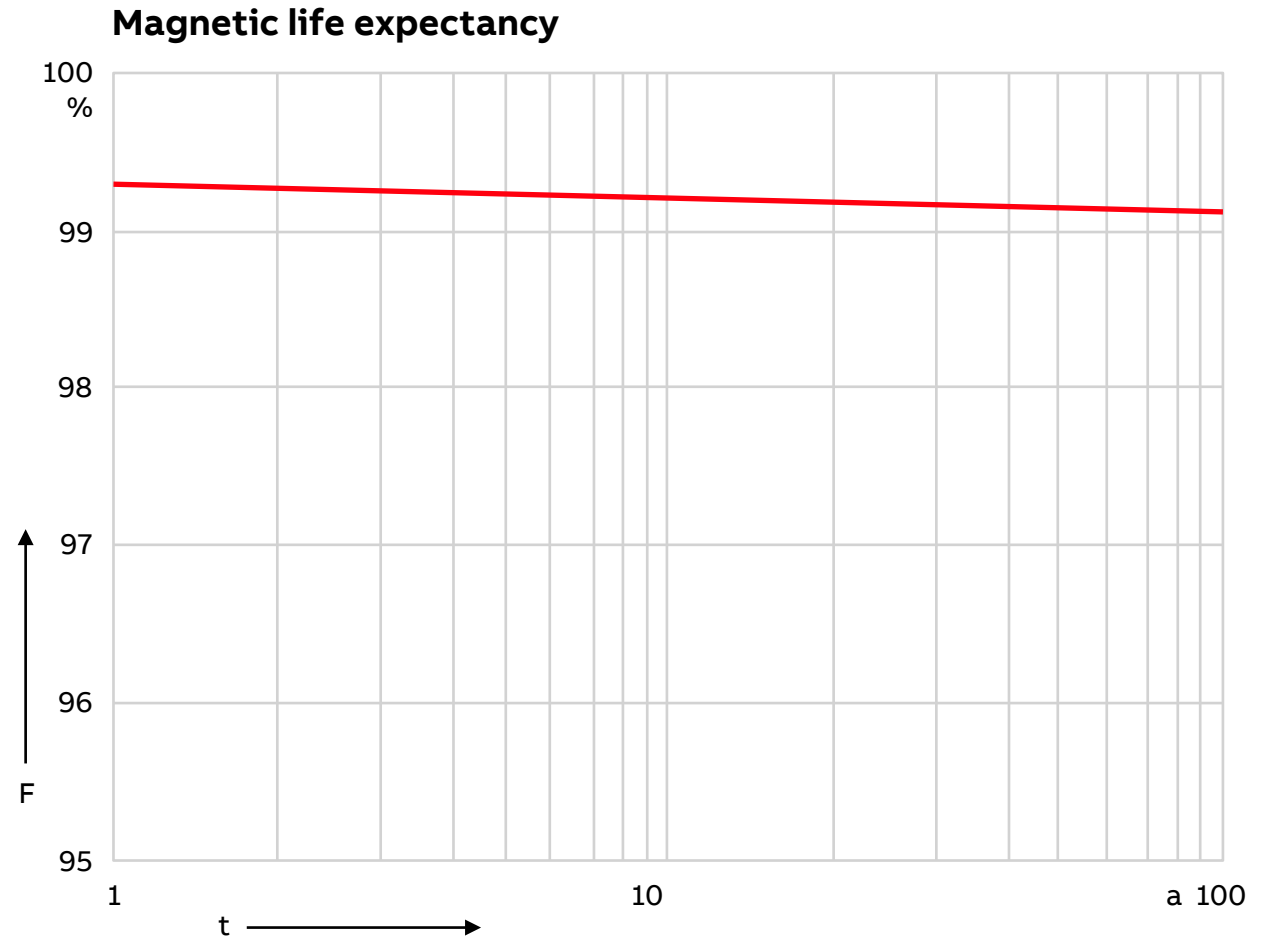

# R-MAG circuit breaker

## Vacuum Interrupters

### Vacuum Interrupters

- One of the largest vacuum interrupter producers in the world
- Manufacturing in Ratingen, Germany, since 1980
- Environmentally friendly and maintenance-free for life
- Latest technologies for high quality mass-production
- Compact and robust design
- Worldwide, more than 5 million ABB vacuum interrupters are in service in several ABB products

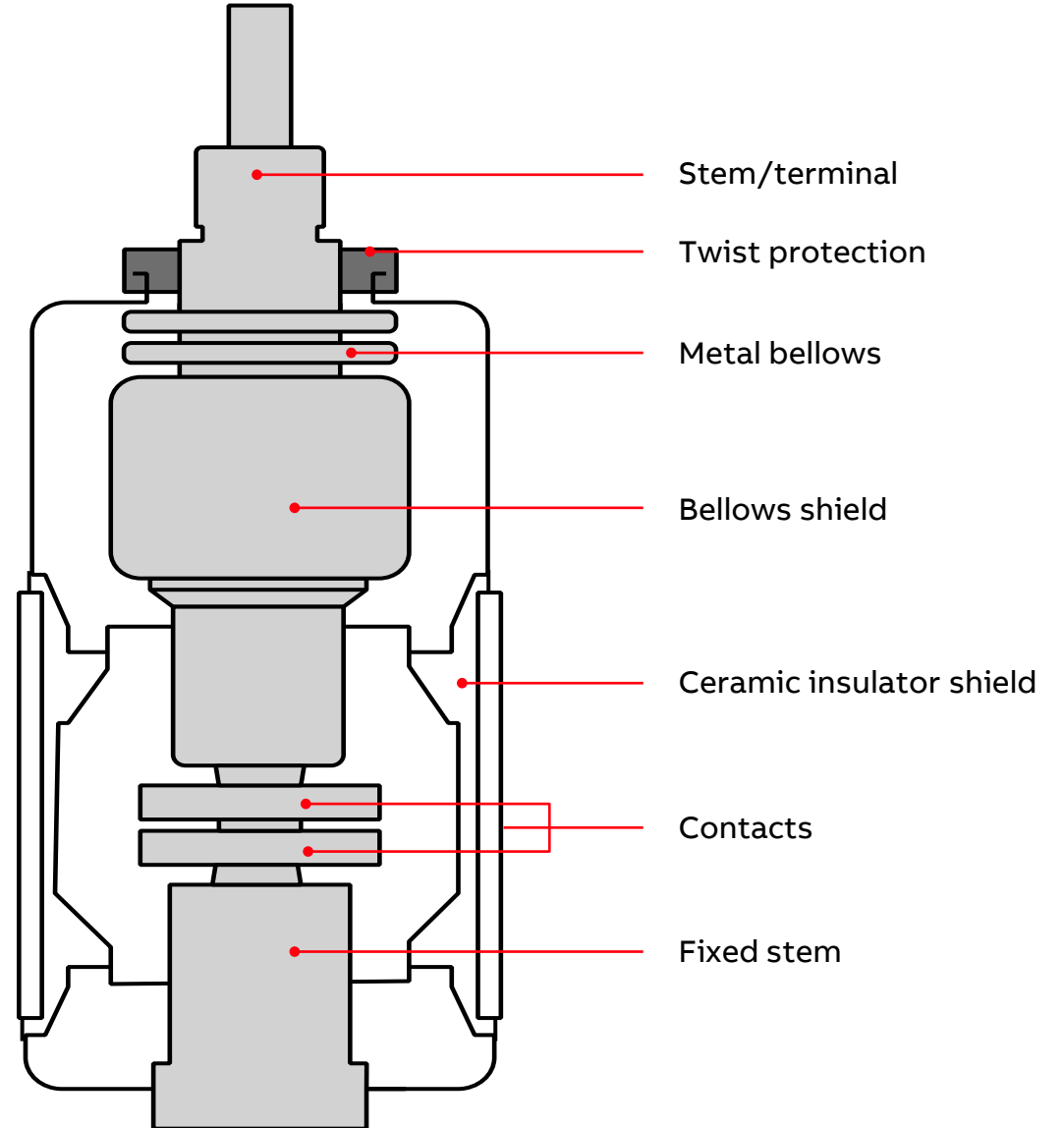



# R-MAG circuit breaker

## Vacuum interrupters

### Vacuum interrupters

- Rated for 30,000 mechanical or load operations
- Up to 40 operations at maximum interrupting rating for 15 kV
- Up to 50 operations at maximum interrupting rating for 38 kV
- Well above the industry norm of 10,000 no load operations

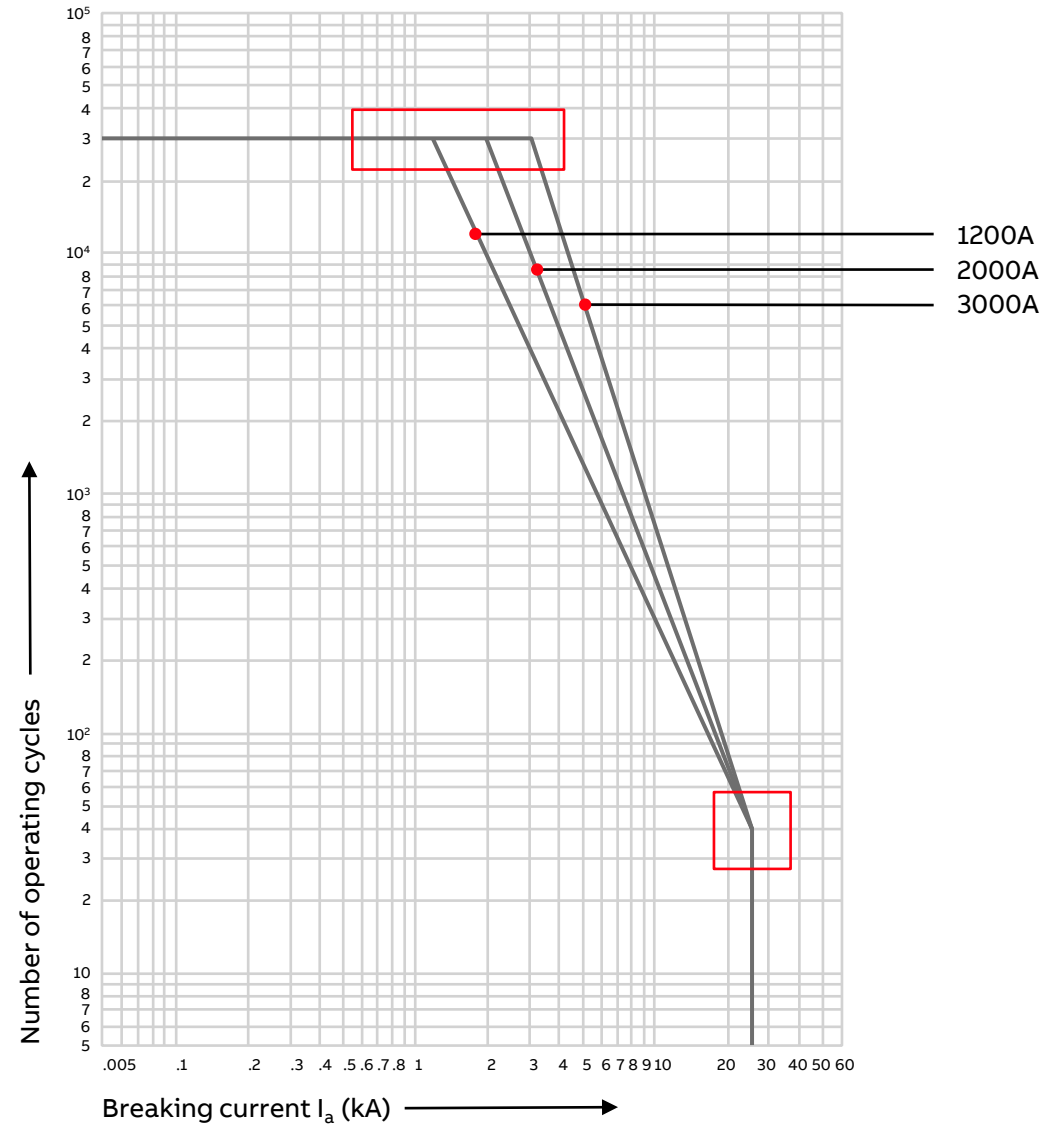

# R-MAG circuit breaker

## ED2.0 electronic control board

### ED2.0 electronic control board

- Controls magnetic actuator, receives trip/close signals, monitors position, local/remote control, monitors and alarms
- Monitors control power, position sensors and continuity of the trip and close coils
- Low power requirements
- Plug and play design of the ED2 electronic control board for rapid replacement in the field

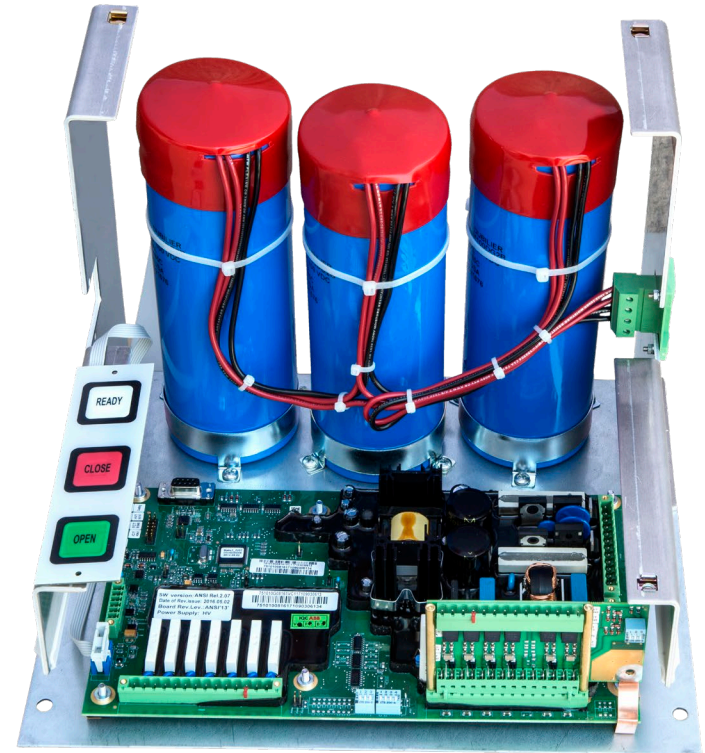

# R-MAG circuit breaker

## ED2.0 electronic control board

### Benefits and advantages

#### Flexibility of control voltages

- Two control boards cover all control power requirements:
  - Low voltage: 17 – 75 VDC or 21 – 52 VAC
  - High voltage: 77 – 280 VDC or 85 – 264 VAC

#### Wide range of input voltages

- Minimizes damage from voltage spikes or higher charging voltages

#### Low power requirements – 93W normal (41W power optional)

- Less than 1A at 125 VDC during capacitor charging

#### No risk of coil burning

- Trip/close signals are monitored by digital inputs that operate under voltage difference and not under coil current charging

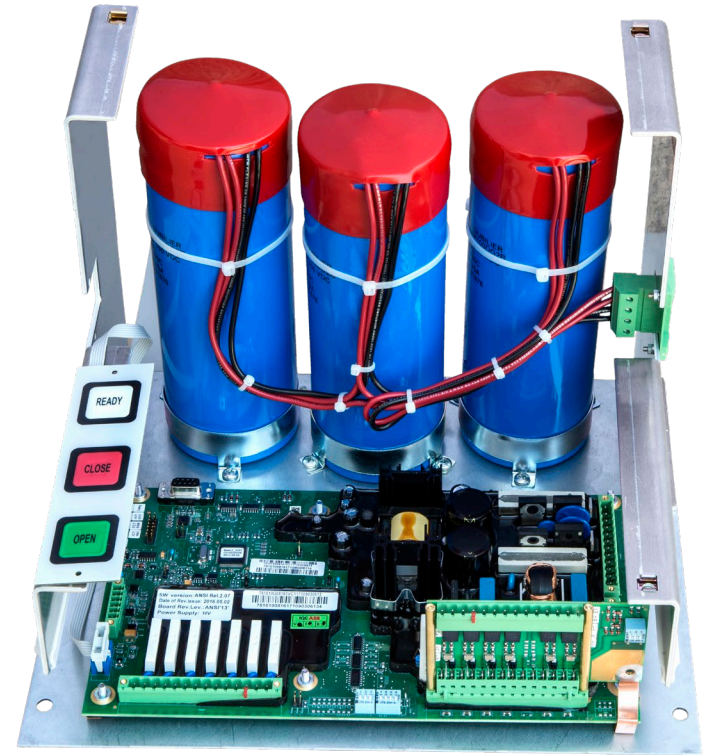

# R-MAG circuit breaker

## ED2.0 electronic control board

### ED2.0 board self supervision

- ED2.0 is constantly supervising the main components of the R-MAG breaker (magnetic actuator, capacitors and board)
- ED2.0 incorporates two NO/NC contacts (Unit-Ready and Not-Ready output contacts) to provide alarms under the following conditions
  - Drop off auxiliary supply voltage
  - Low voltage on capacitor
  - Unstable connection between the electronic board and actuator
  - Correct position of main contacts after a trip/close command
  - Failure in electronic board

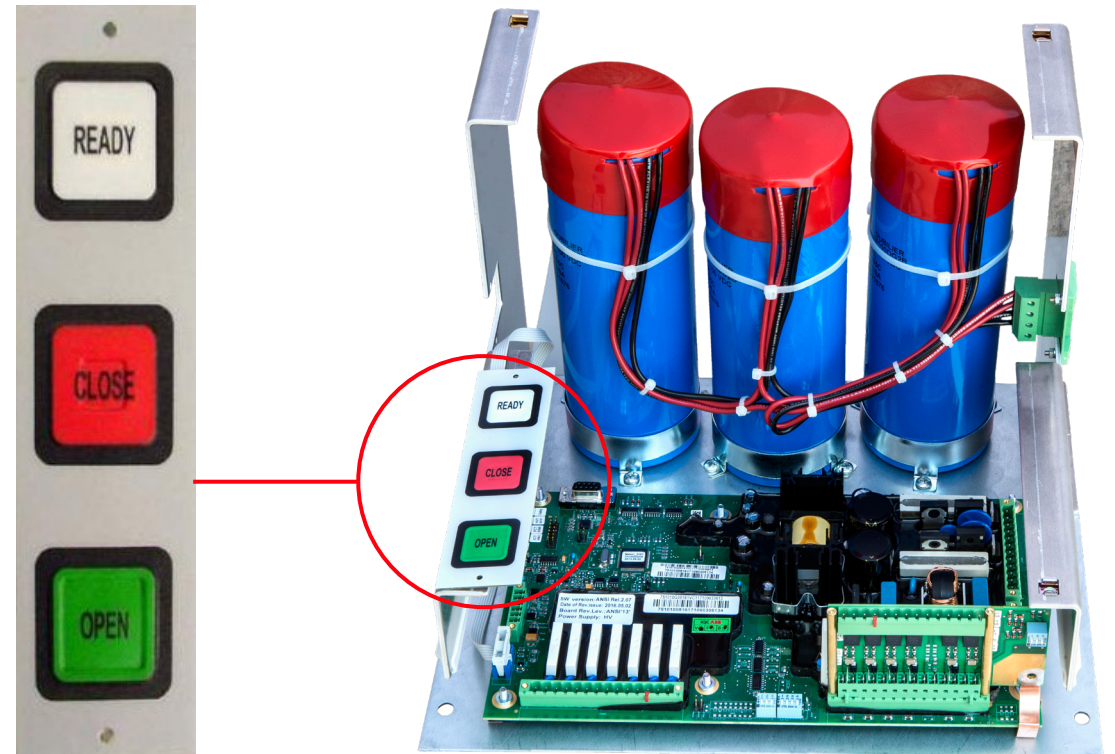

# R-MAG circuit breaker

## Manual emergency trip

### Manual emergency trip

- Available in all R-MAG ratings
- Manual trip lever electronically interlocked to prevent closing in close block position – 69 function
- When manually tripped, closing is electrically blocked:
  - When tripped, handle returns to the close blocked position
  - Will not allow closing until lever is moved to normal operating position
  - Ready to receive padlock to block the lever in unblocked/blocked position



# R-MAG circuit breaker

Housing: NextGeneration housing

## NextGeneration R-MAG

- Protection against water and dust above the traditional NEMA3R design
- Introduction of roof overhang that limits water exposure
- Introduction of 3-point door latching system, hinges, gaskets and other expert OEM elements
- No vents needed for any rating
- Use of only one door on LV compartment to help ensure even and smooth sealing
- State-of-the-art gaskets and sealers used to prevent any water ingress from metal-to-metal joints
- Hinged door in HV compartment as optional
- Automatic door stop
- Self sealing external bolts



# R-MAG circuit breaker

Housing: NextGeneration housing

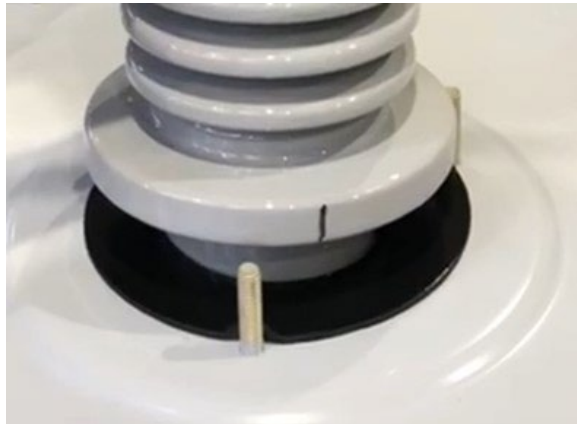

New self-sealing bushing gasket



Bushing brackets made of casted aluminum and four fixing bolts to help ensure even distribution of fixing bushing force



Introduction of expert OEM elements like 3-point door latching system, hinges, gaskets, etc.



Use of self-sealing bolts in all external bolts

---

# R-MAG circuit breaker

Housing: NextGeneration housing



New roof overhang limits the door's water exposure

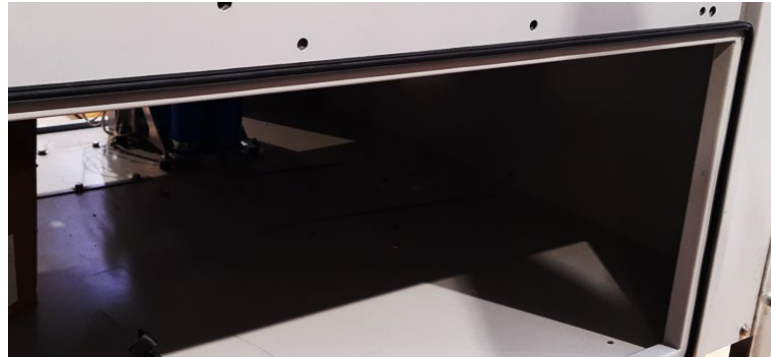

Introduction of single door in LV compartment for all R-MAG ratings to help ensure perfect door sealing



Galvanized steel lifting lugs to avoid paint scratching/removal and corrosion



# R-MAG circuit breaker

Housing: NextGeneration housing

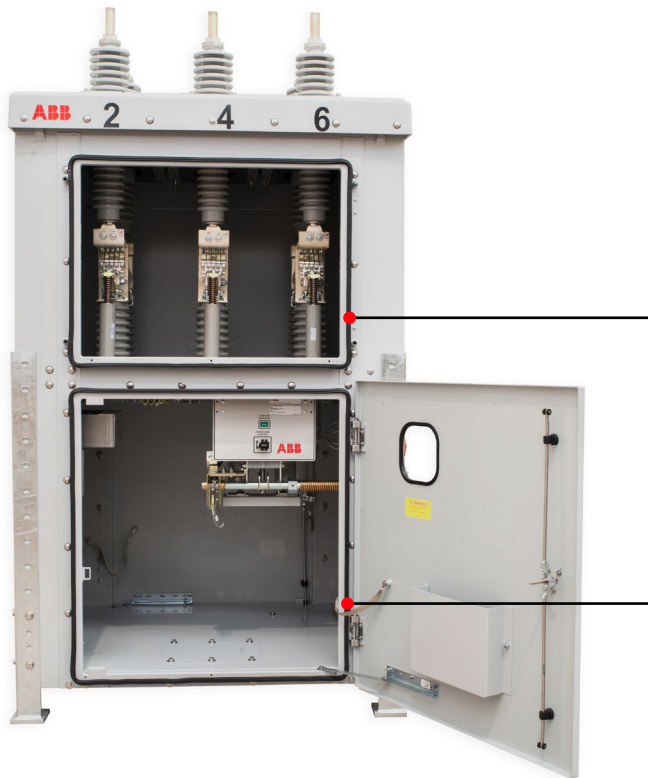

No vents in HV compartment for heat dissipation needed for any rating

Standard bolted cover for HV compartment, optional hinged HV door

Completely new housing gasketing system

Footprint size reduction in 15 kV 2000 A, 27 kV 1200 A and 27 kV 2000 A. From 60 in. width to 52 in. width



---

# R-MAG circuit breaker

## R-MAG exceeds maintenance requirements

### Maintenance requirements

- The R-MAG breaker incorporates several state-of-the-art elements that help ensure extremely low maintenance requirements:
  - New housing designed above the traditional NEMA3R requirements
  - Industry leader vacuum interrupters
  - Maintenance-free mechanism (magnetic actuator)

### ANSI C37.06-2000 requirements:

- 500 operations between servicing
- 2,000 no-load mechanical operations

### R-MAG standard

- Quick inspection every 2,000 operations



# R-MAG circuit breaker

Housing: interface

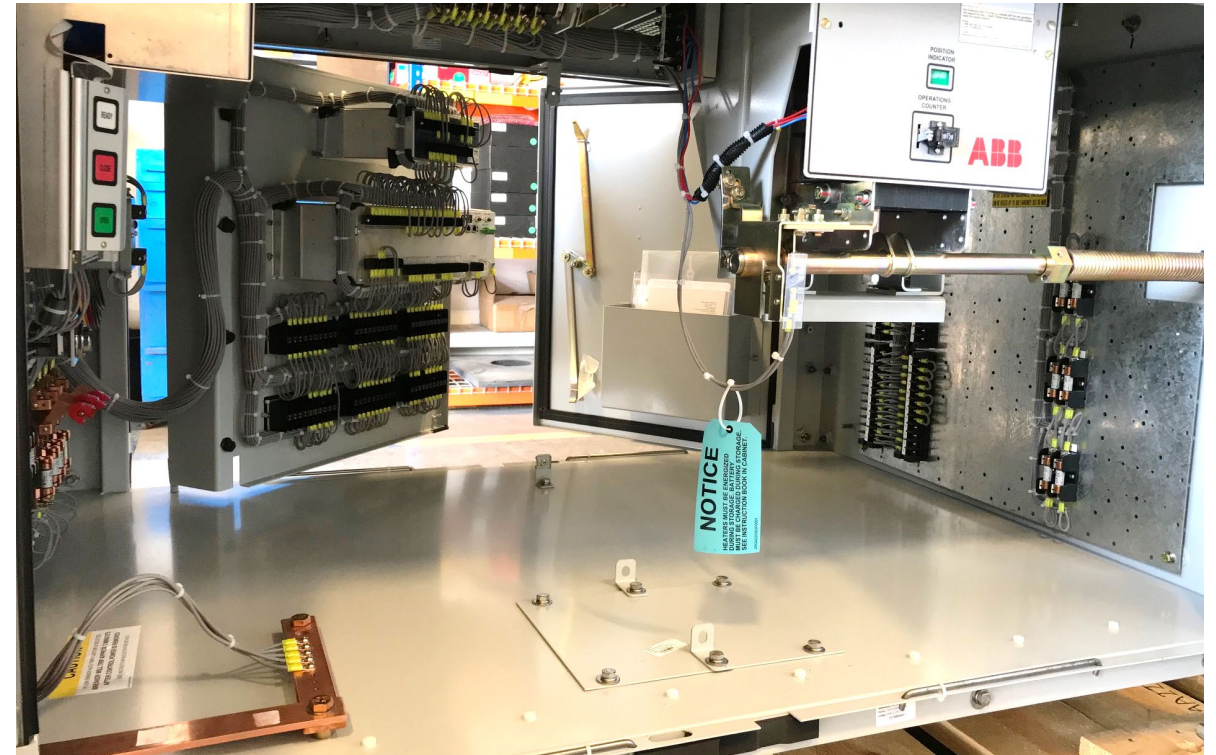

Simple and clean interface / Easy access to LV wiring / Large personnel access

# R-MAG circuit breaker

High customization level

## Current transformers

- 15 kV and 27 kV R-MAG accommodates up to two CTs per bushing (4 per phase)
- 38 kV R-MAG accommodates up to three CTs per bushing (6 per phase)
- CT relay accuracy ranges from C100 to C800 (C400 standard)
- Ratios range from 600:5 to 6000:5
- Design/operation according IEEE, IEC, etc.



# R-MAG circuit breaker

High customization level

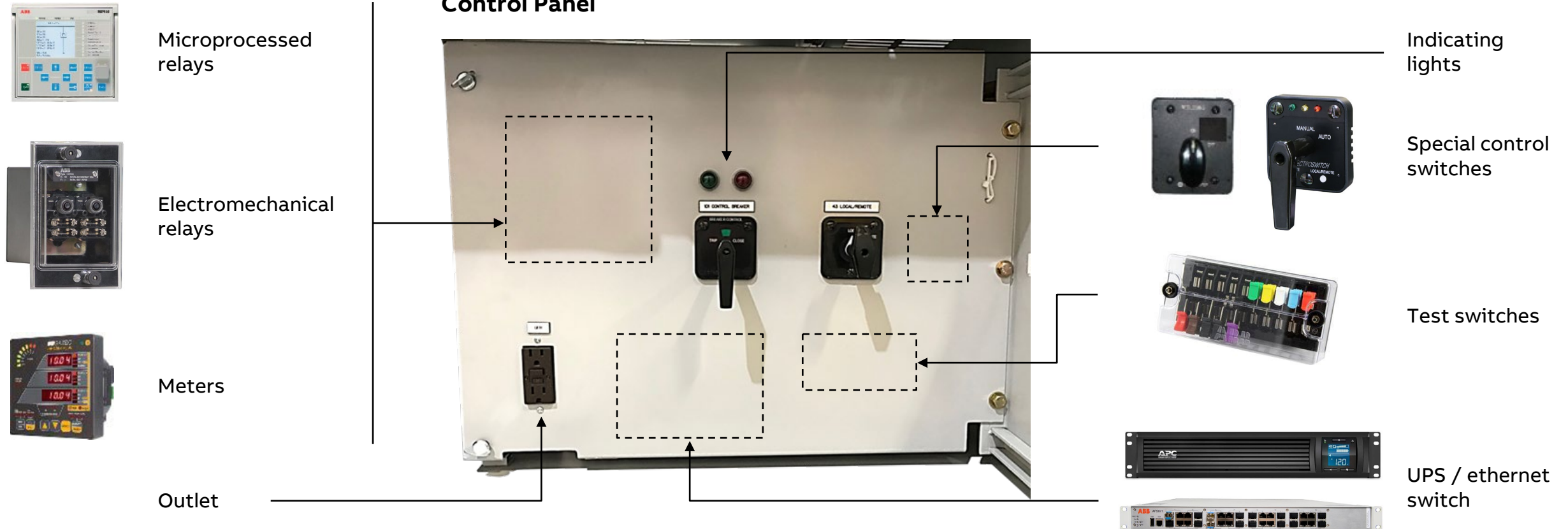

# R-MAG circuit breaker

High customization level

## Extra large creepage bushing

Standard bushing creepage: 25 mm/kV  
Optional extra large creepage: 31.5 mm/kV  
Ideal for coastal and very polluted areas



## Housing customizations available

Ready to be fabricated in several colors and introduce mechanical customizations to cabinet to meet customer specifications



## Seismic and wind load tested

The R-MAG breaker has been tested as per the latest relevant standards to meet seismic and wind load qualifications

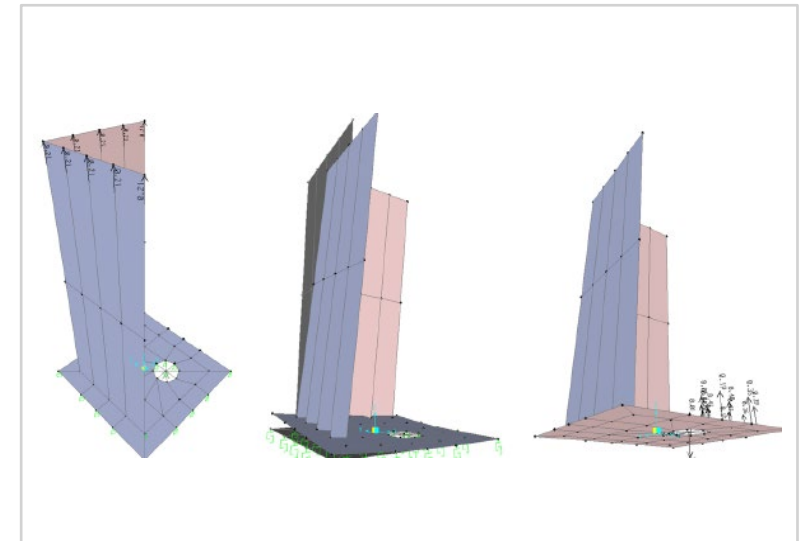

# R-MAG circuit breaker

## Product portfolio

### Ratings

- 15.5 kV to 38 kV rated maximum voltage
- 110 kV to 200 kV BIL
- 12 kA to 40 kA interrupting current
- 1200 A to 3700 A continuous current
- 10,000 mechanical or load operations
- Optimized NEMA3R housing

### Coming soon:

- New NEMA4 housing
- New Arc Resistant housing



# R-MAG circuit breaker

## Ratings

	R-MAG outdoor breaker			
Voltage (kV)	15.5	27	38	38
Continuous current (A)	1200/2000/3000/370 <sup>1</sup>	1200/2000	1200/2000	1200/2000
Interrupting current (kA)	12 – 25	12 – 25	25 – 31.5	40
Lightning impulse withstand voltage (BIL, kV)	110	125 – 150	200	200
Frequency (Hz)	50 / 60	50 / 60	50 / 60	50 / 60
Interrupting time (Cycles)	3	3	3	3.5
Isolated capacitor bank switching current (A)	600	600	630	N/A
Back-to-back capacitor bank switching current (A)	600	600	630	N/A
Mechanical life (mechanical or load operations)	10,000	10,000	10,000	10,000
Operating duty (standard duty)	O–0.3 sec–CO–3 min–CO			

1. Forced air cooling on 15 kV 3700 A only



---

# R-MAG circuit breaker

## Customer support

### On-demand training

- Training videos available online
- General breaker overview
- Troubleshooting overview

### On-site training

- One-day training at any customer defined location

### Customer service

- 24/7 customer service based in Lake Mary, FL
- 24/7 ABB general support line: 1-800-365-HELP



# R-MAG circuit breaker

## Key benefits

- Maintenance is easy and safe
- Significantly reduced maintenance time
- Control and mechanical design ready to be customized and meet most complex specifications
- Full 5-year warranty

**With top rated internal components, the R-MAG provides unparalleled reliability**

**20 years of field proven capability**

**Over 30,000 R-MAG units installed**

In very low and high temp locations (Canada, Chile), High humidity (Florida), Polluted cities (Mexico city) and desert-like areas



**ABB**