

Technical Information

30/24-200-2 EN

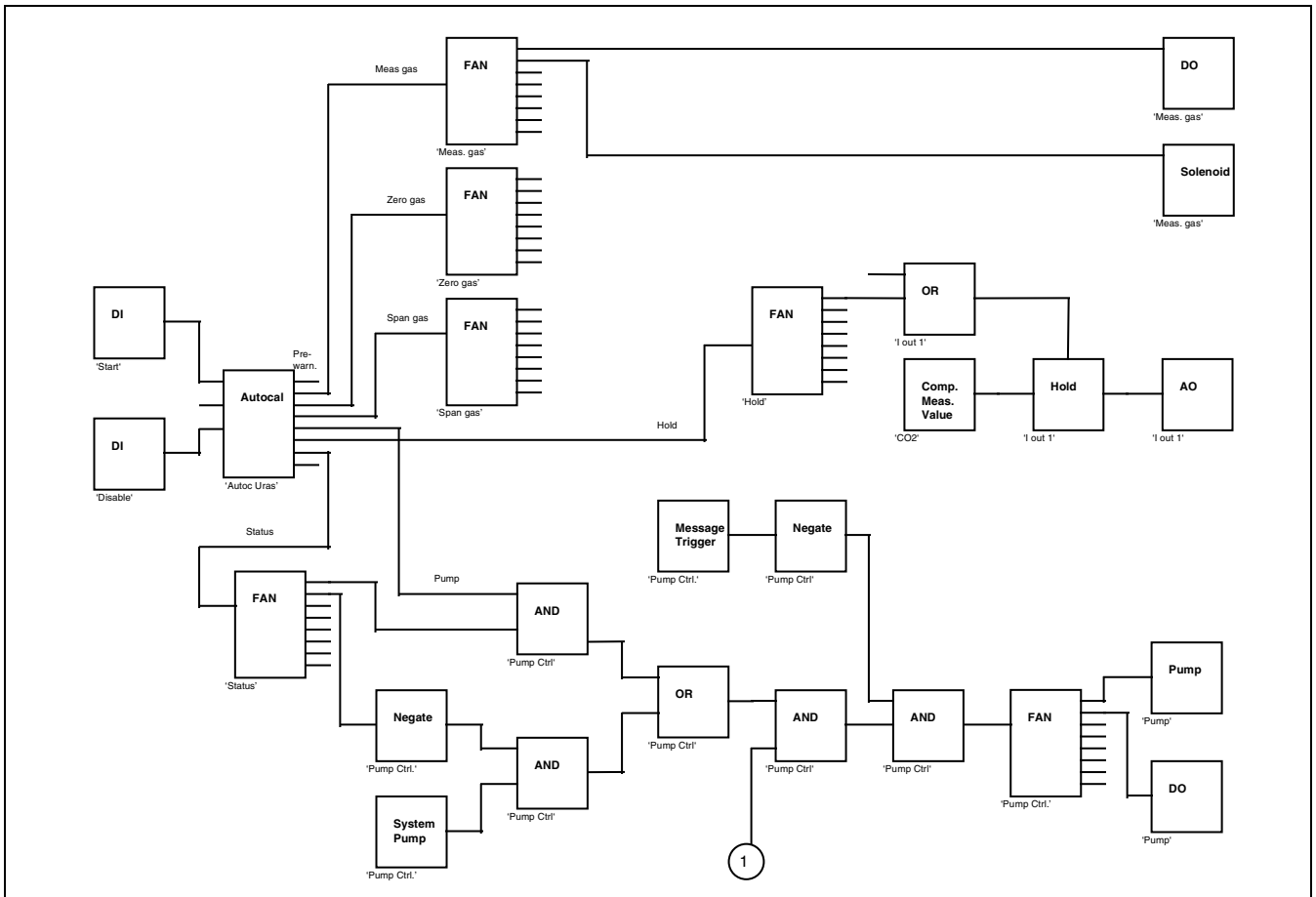

	Page
	A few preliminary words 3
Chapter 1	
	Configuration
	What are function blocks? 4
	Standard Configuration..... 7
	Example: "Limit Monitor"..... 8
	Example: "Range Control/Feedback" 9
	Function Block Linking and Initializing 11
	Function Block Linking..... 13
Chapter 2	
	Descriptions
	Function Block Overview 18
	Limit Monitor 19
	Hold 20
	Feedback..... 21
	Timer 22
	Sequencer 24
	Access Lock 26
	Digital Input..... 27
	Analog Input 28
	Message Input 29
	Constant 30
	Digital Output..... 31
	Analog Output..... 32
	Message Insert 34
	Negate 35
	Add 36
	Subtract 37
	Multiply 38
	Divide..... 39
	Or..... 40
	And 41
	Linear Converter..... 42
	Fan 43
	Multiplexer 44
	Demultiplexer..... 45
	Priority Encoder 46
	Priority Decoder..... 47
	Binary → Decimal..... 48
	Decimal → Binary..... 49
	Component Measured Value 50
	Detector Measured Value 51
	Component Range 52
	Range Control 53
	Range Feedback 54
	Active Component Multiplexer 55
	Calibration Cell 57
	Solenoids..... 58
	System Pump 59
	Pump 60
	Autocalibration 61
	Externally Controlled Calibration 63
	Cross-Sensitivity Correction 64
	Carrier Gas Correction 65

A few preliminary words ...

... on the content of this Technical Information Publication

This technical information publication contains information on the Advance Optima analyzer system function blocks.

Chapter 1 describes what function blocks are and how they are configured.

Chapter 2 contains a detailed description of the use and functionality of each function block along with its parameters and an example of how it is used.

Examples of special, application-oriented function block configurations are contained in a separate document available from ABB Analytical.

... on Supplementary Documentation

The following publications are available to supplement this technical information document:

Title	Publication No.
Sales Brochure	50/24-01 EN
Data Sheet	10/24-1.10 EN
System Description	30/24-110 EN
Operator's Manual	42/24-10 EN

These publications can be ordered from your authorized ABB Automation Products representative or from

ABB Automation Products GmbH, Marketing Communication,
Telefax: +49-61 96-8 00-45 66, E-mail: analytical-mkt.deapr@de.abb.com

... Formatting Conventions Used in this Manual

Some types of text are identified with special formatting:

Designation Identifies a function block designation.

'Name' Identifies a function block name assigned by the system or entered by the user.

Display Identifies a display on the screen.

Input Identifies a user entry

- Either by pressing a softkey
- By selecting a menu item
- or via the numeric keypad.

This technical information publication is protected by copyright. The translation, duplication and distribution in any form, even in a revised edition or in extracts, in particular as a reprint, by photomechanical or electronic reproduction or in the form of storage in data processing systems or data networks are prohibited without the consent of the copyright holder and will be prosecuted under civil and criminal law.

What are function blocks?

Function Block = Micromachine

A function block basically represents a micromachine operating within Advance Optima. It receives an input, processes it and returns an output.

Fig. 1 shows this micro machine in the form of a function block. Input to the machine – shown as an arrow – enters from the left and is processed by the machine to produce an output (right arrow).

What the machine actually does is not shown in this example. The operation could, for example, be multiplication of the input value by the factor 2. Later we will describe how to define the operation performed by the function block.

Figure 1
Function Block

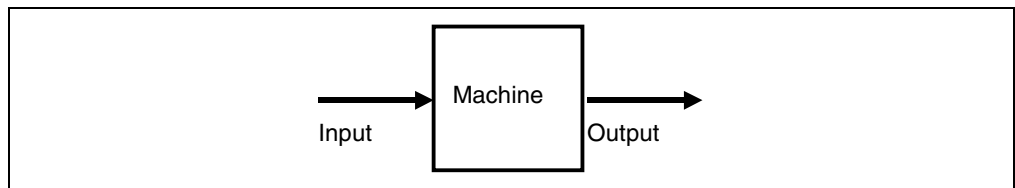

Function Block Linking

Outputs from function blocks can in turn be used as inputs for other function blocks, by which means chains of function blocks can be set up (see Fig. 2). A chain of several function blocks is referred to as an “application”.

Figure 2
Chain of Function Blocks

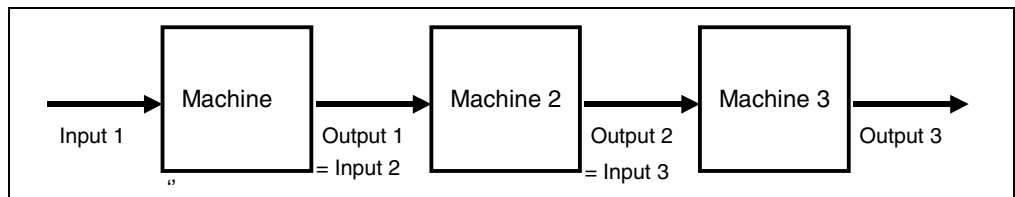

Function Blocks with only an Input or only an Output

There are function blocks which have only an input and no output. In this case, the block may, for instance, represent a digital or analog output provided in Advance Optima (see Fig. 3).

The results produced by such function blocks can be output as electrical signals to the Advance Optima hardware interfaces, where they can be further processed using conventional techniques.

There are also function blocks which have an output but no input. These may, for instance, represent digital and analog inputs.

Figure 3
Function Blocks with only an Input or only an Output



Continued on next page

What are function blocks?, continued

Conventions

There are certain conventions applied in the depiction of function blocks. Inputs to the function blocks are always drawn as arrows coming from the left; outputs come out of the function block to the right. This clarity of flow direction makes it possible to dispense with arrows in many cases and draw simple lines instead.

Arrows = Movement of Information

The arrows or connections transfer analog, binary and decimal information, i.e. arrows and connections correspond to different types of information. Attention should therefore be paid to which arrows are linked with which inputs.

Calculation Operations

For performing calculations on analog data, function blocks are provided representing the 4 most basic calculation operations:

Figure 4

Calculation Operations

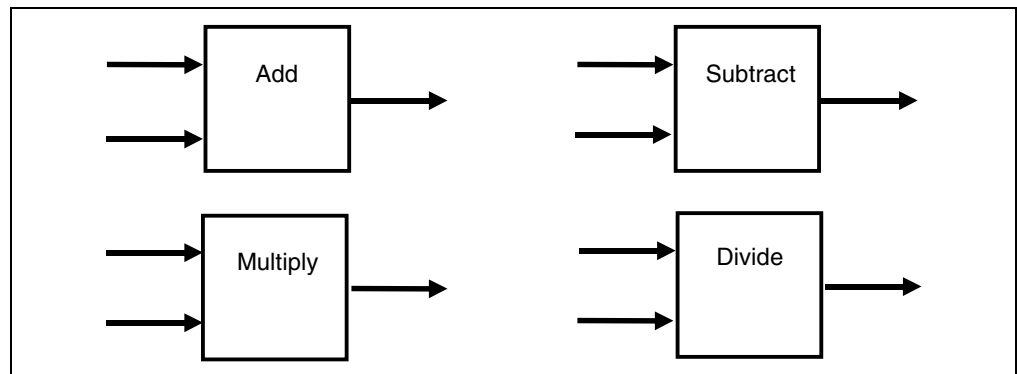

Logic Operations

The logical operators AND and OR are provided for processing and linking digital information (0/1 or On/Off).

Figure 5

Logic Operations

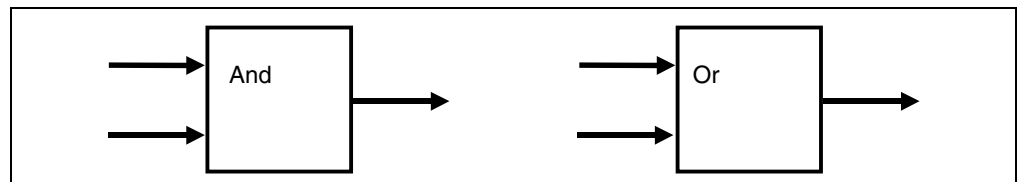

Continued on next page

Measured Values from Analyzer Modules

Until now only those function blocks have been presented which present a link to outside and which can process this information internally. Until now we have not been able to integrate measured values and other data with the available function blocks.

The measured value can probably be described as the most important data item. The measured value is received via the **Component measured value** function block. At system startup time these function blocks are generated automatically according to the configuration of the analyzers and the number of measured components.

The **Component measured value** function block to an **Analog input**. This function block is not, however, linked with a physical input, but receives its values internally from the appropriate analyzer module.

2 Measured Value Blocks for Each Component

Two different blocks of measured values are generated for each component (see Figure 6). One shows the measured value as a percentage of the range of measured values, while the other shows it in physical units.

Figure 6
Measured Values

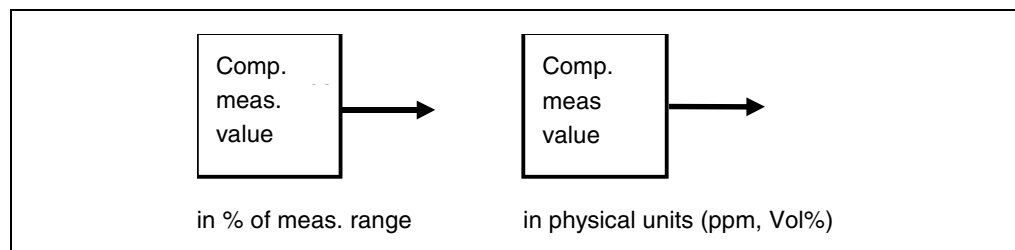

Raw Measured Values

The raw measured values can similarly be read and post-processed. For this function, too, a function block **Detector measured value** is generated automatically for each component.

Function Block Configuration Advantages

- New functions such as limit monitoring can be added simply at any time
⇒ flexible adaptation to new requirements
- Enables even quite complex automation applications to be programmed
⇒ e.g. autocalibration of systems
- No additional instrumentation required, e.g. for displaying external error messages
⇒ Reduced hardware requirement
- Straightforward integration of external hardware components such as flow monitors, and status signals can be integrated into the system status
⇒ Reduced costs, as there is no longer any need for additional signal processing
⇒ System component error messages on screen in clear text
⇒ Straightforward transmission of error messages via the service bus, a prerequisite for remote operation and maintenance

Standard Configuration

Standard Configuration

Various applications are factory-configured. These standard configurations are based on

- The standard I/O arrangement (see Figure 7)
- The available sample components

Some factory-configured applications require field linking of additional function blocks.

☞ The standard I/O arrangement is shown on a separate sheet supplied with each analyzer system.

Figure 7

System Controller Standard Configuration

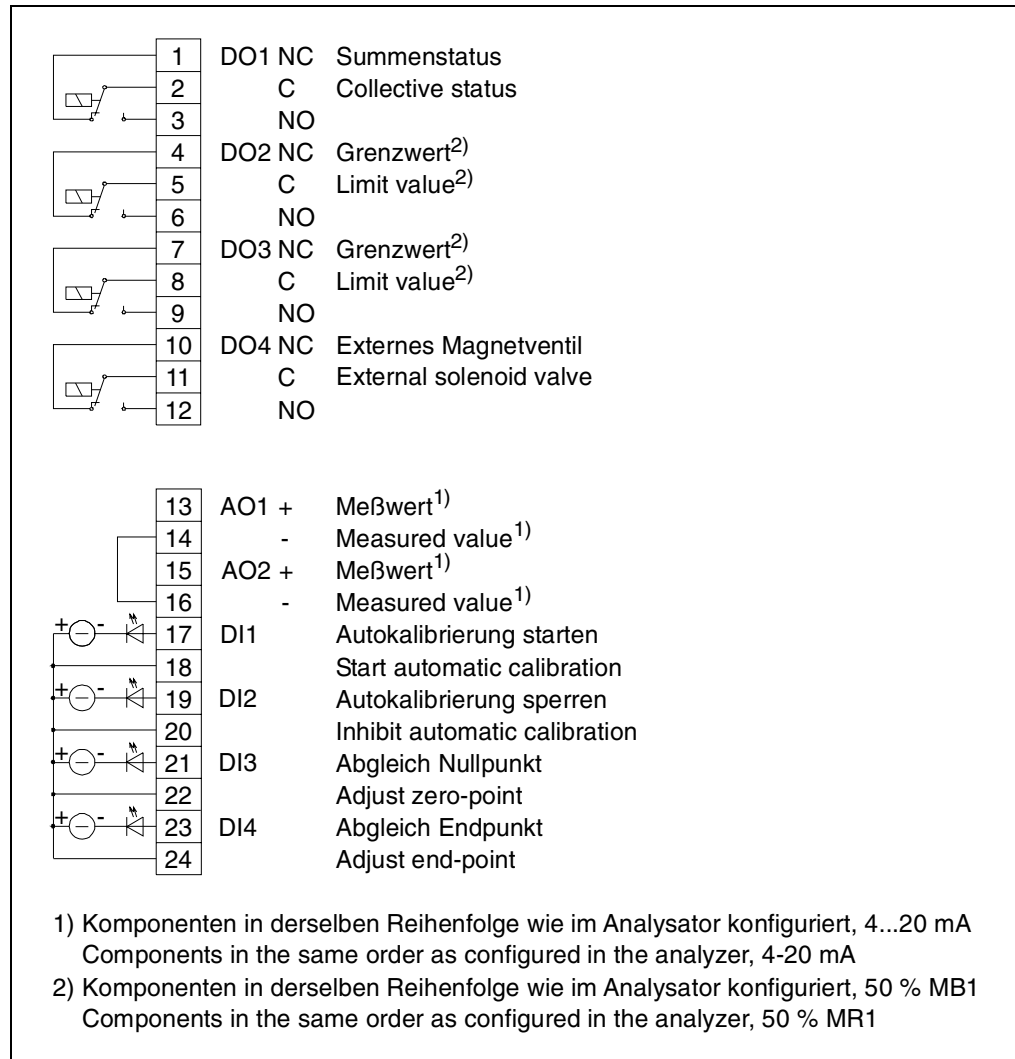

Example: "Limit Monitor"

Function Blocks

A limit monitor consists of the following function blocks (see Figure 8).

- **Component measured value** (in physical units)
- **Hold**
- **Limit monitor** and
- **Digital output**

By linking these function blocks: The component measured value is monitored for violations of initialized limit values and the result is passed to the digital output. The hold function disables limit value monitoring, e.g. during autocalibration.

Figure 8
Limit Monitoring

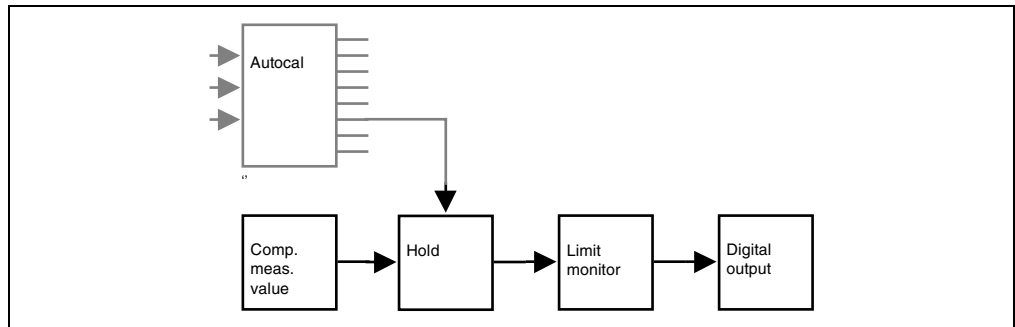

Standard Configuration

As a rule, limit monitoring for those components to be measured by the analyzer system is factory-set. This requires that there be enough digital outputs on the system controller and I/O boards to handle the number of sample components.

Setting Parameters

Proceed as follows to configure the **Limit monitor** function block:

Parameter	Explanation	Action
FB Name	Depends on component to be monitored	Enter
FB Enable	Activated or Not activated	Select
FB Status	OK	Display
Input 1	Link via Hold to Component measured value ¹⁾	Preconfigured
Output 1	Link to Digital output ¹⁾	Preconfigured
Direction	< = Alarm on underflow or > = Alarm on exceeding threshold value	Select
Threshold	in physical units	Set
Hysteresis	in physical units	Set

1) Per standard input/output arrangement

Example: "Range Control/Feedback"

Function Blocks

A measurement range switching/feedback element consists of the following function blocks (see Figure 9).

- **Digital input**
- **Range control**
- **Component range**
- **Range feedback** and
- **Digital output**

By linking these function blocks: A control signal at one of the digital inputs switches to one of the ranges stored in the **Component range** function block. This change produces a signal at one of the digital outputs.

Figure 9

Range Control/Feedback

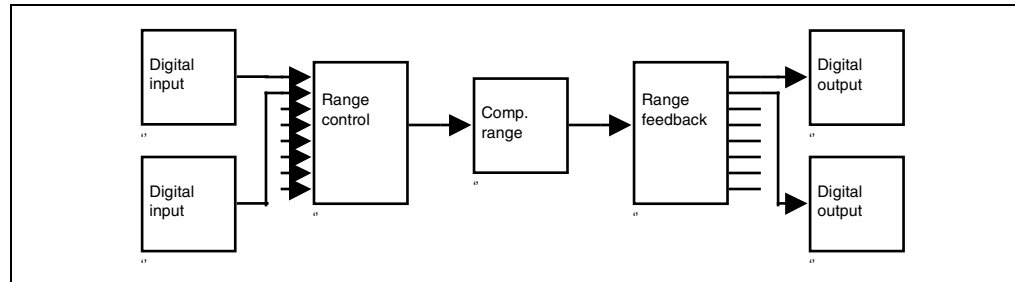

Standard Configuration

Generally, the measurement range switching/feedback function is factory-set for the first of the sample components to be measured in the analyzer system. This requires that there be enough digital inputs and outputs on the I/O boards to handle the number of measurement ranges.

Range Switching Configuration

Proceed as follows to configure the **Range control** function block:

Parameter	Explanation	Action
FB Name	per the component to be switched	Enter
FB Enable	Activated or Not activated	Select
FB Status	OK	Display
Output 1	Link to Component range	Preconfigured
Input 1	Link to Digital input ¹⁾	Preconfigured
Input 2	Link to Digital input ¹⁾	Preconfigured
Input 3	Link to Digital input ¹⁾	Preconfigured
Input 4	Link to Digital input ¹⁾	Preconfigured
Operation	Priority Encoded or Binary → Decimal	Select

1) Per standard input/output arrangement

Continued on next page

Example: "Range Control/Feedback", continued

Range Feedback Configuration

Proceed as follows to configure the **Range Feedback** function block:

Parameter	Explanation	Action
FB Name	per the component to be reported	Enter
FB Enable	Activated or Not activated	Select
FB Status	OK	Display
Input 1	Link to Component range	Preconfigured
Output 1	Link to Digital output ¹⁾	Preconfigured
Output 2	Link to Digital output ¹⁾	Preconfigured
Output 3	Link to Digital output ¹⁾	Preconfigured
Output 4	Link to Digital output ¹⁾	Preconfigured
Operation	Priority Decoded or Decimal → Binary	Select

1) Per standard input/output arrangement

Signal Level

A Low → High edge signal at the corresponding digital input is required to control range switching. Make sure the signal appears at only one digital input.

The measurement range selected is reported by means of a high signal sent to the applicable digital output.

Low Level 0–5 V, High Level 8–24 V

Function Block Linking and Initializing

Configuration planning

Before starting a configuration we recommend using a chart to plan the function blocks needed for the application to be configured and how the inputs and outputs are linked.

Hardware requirements, e.g. the number of installed and available input and output terminals, need to be considered.



CAUTION!

The access level 3 password (default: 325465) must be entered in order to configure an application. Make sure that existing application configurations and links are not damaged or deleted when configuring.

Function Block Menu Display

When the function blocks to be linked are selected, only those function blocks eligible for linking are shown; all other function blocks are represented by . . .

Softkeys

The following specific softkeys are displayed when an input or output is selected during function block configuration.



The DELETE LINK softkey allows the operator to remove any links from the selected input or output.



The >> softkey switches the operator directly to the function block linked to the input or output selected.

Explanation of Individual Parameters

Some parameters apply to every function block. There are explained below.

FB Name

The system automatically generates a name for any newly added function block, consisting of the function block type (abbreviated as necessary) and a sequential number.

Example: For the first **Limit monitor** type function block the system issues the name 'Limit1'.

The operator can change this name. The function block name should not exceed 8 characters in length. We recommend assigning the same names to all function blocks making up an application.

Example: All function blocks used for limit monitoring of the CO component value receive the name 'Alarm CO' (see Figure 10).

Figure 10

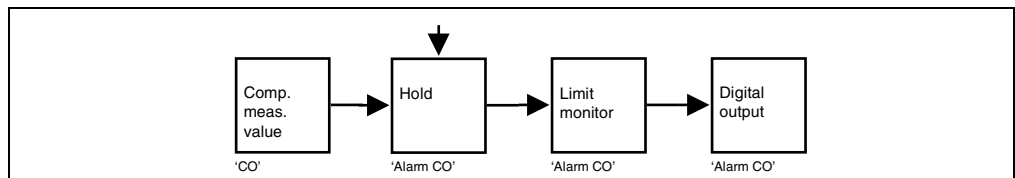

Continued on next page

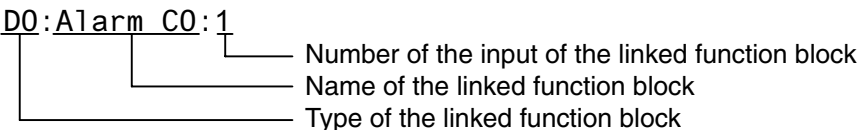
- FB Enable** The `FB Enable` parameter allows the operator to select whether the function block is activated or not.
Normally the value is set to `activated`.
- FB Value** The `FB Value` parameter shows the current function block value.
Example: The **Digital output** function block uses the `FB Value` parameter to indicate whether the output is `on` or `off`.
- FB Status** The `FB Status` parameter shows the current function block status.
Normally the value is set to `OK`. Any other indication is a sign of an error in the function block.
- HW Status** The `HW Status` parameter shows the current status of hardware connected to the function block, e.g. an analog output.
Normally the value is set to `OK`. Any other indication is a sign of an error in the hardware associated with the function block, e.g. an open line on an analog output.
- Input, Output** A function block's `Input` and `Output` parameters identify the input and output links to another function block.
Additionally, the value or status of the linked function block input or output is shown.
Example (refer to Figure 10):
Display at Output 1 of the **Limit monitor** function block:
- DO:Alarm CO:1
- 
- The diagram shows the text `DO:Alarm CO:1` with three lines of brackets pointing to its parts: a bracket under '1' points to 'Number of the input of the linked function block', a bracket under 'Alarm' points to 'Name of the linked function block', and a bracket under 'DO' points to 'Type of the linked function block'.
- Plain text: **Limit monitor** function block output 1 is linked to input 1 of a **Digital output**-type (DO) function block named 'Alarm CO'.

Function Block Linking

Example

The following simply configured example shows how to link the inputs and outputs of various function blocks.

Two constants are added and the result is multiplied by another value. The following function blocks are required for this function (see Figure 11):

Quantity	Function Block Type	Function Block Name (assigned by the system)
2	Constant	'Const1', 'Const2'
1	Add	'Add1'
1	Multiply	'Mul1'

Figure 11

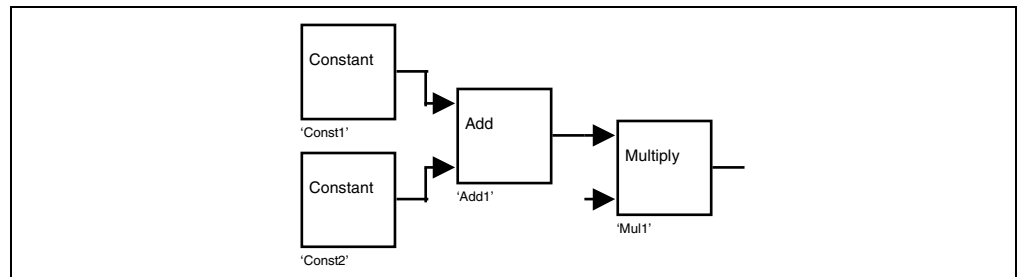

Procedure

The following actions are required to configure the links between these function blocks:

- Select an **Add** function block
- Configure the link between Input 1 and a **Constant** function block
- Configure the link between Input 2 and a **Constant** function block
- Configure the link between Output 1 and a **Multiply** function block
- Configure the function block parameters

Proceed as follows to link the function blocks:

Continued on next page

Step	Action
Select an Add function block	

1 Select the **Add** function block in the Function block menu:

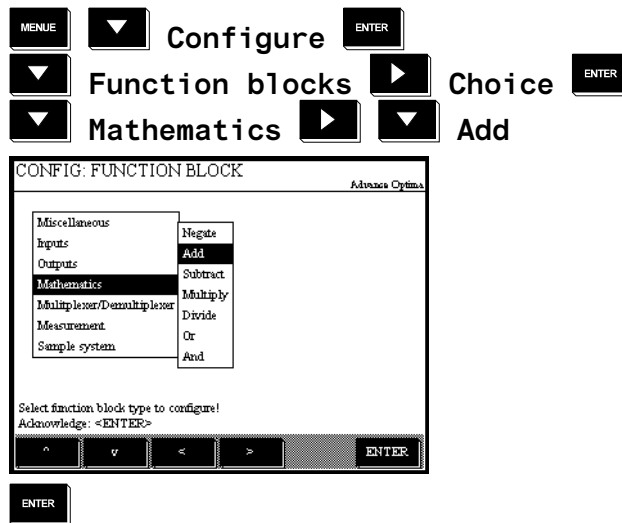

2 Add a new **Add** function block :

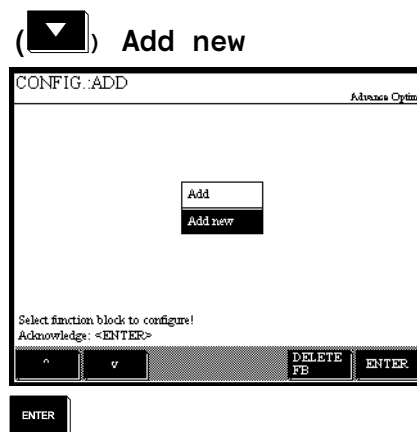

The system generates the 'Add1' function block.

Continued on next page

Step	Action
------	--------

Configure the link between Input 1 and a Constant function block	
---	--

3 Select Input 1 of the 'Add1' function block:

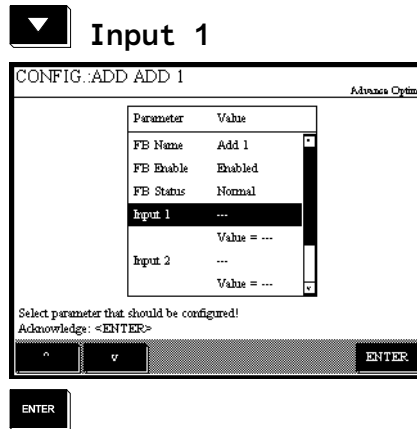

4 Select the **Constant** function block in the Function block menu:

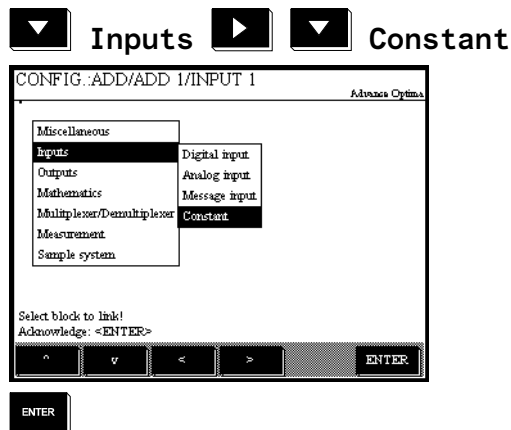

5 Add a new **Constant** function block:

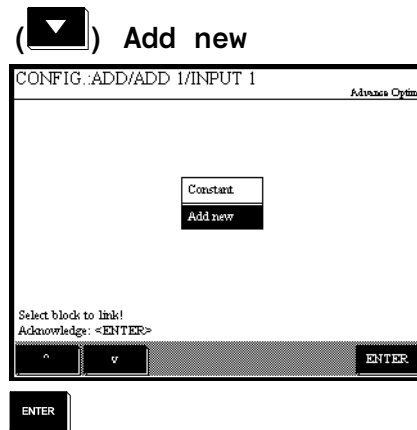

The system generates the 'Const1' function block.

Continued on next page

Step **Action**

6 Link 'Const1' function block Output 1 to 'Add1' function block Input 1:

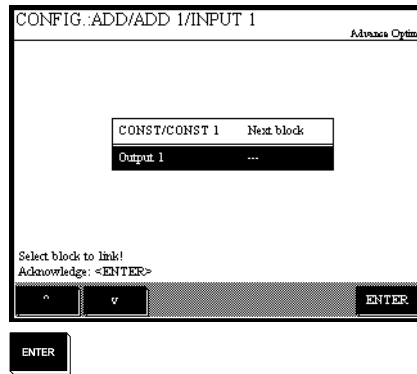

WARNING!
 If Output 1 already shows a link, this link is overwritten and an existing application is deleted when **ENTER** is pressed! To avoid this, use the **Back** key to cancel configuration and prepare a new plan.

Configure the link between Input 2 and a **Constant** function block

7 Configure the link between Input 2 of the 'Add1' function block and the 'Const2' function block:
 Repeat steps 3–6 for Input 2.

Configure the link between Output 1 and a **Multiply** function block

8 Select Output 1 of the 'Add1' function block:

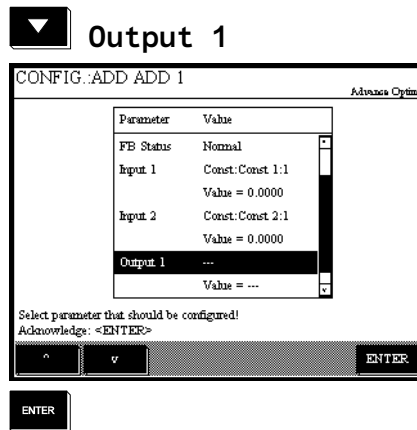

9 Select the **Multiply** function block in the Function block menu:

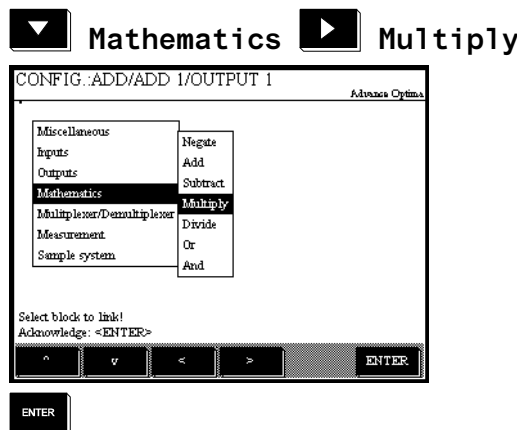

Continued on next page

Step **Action**

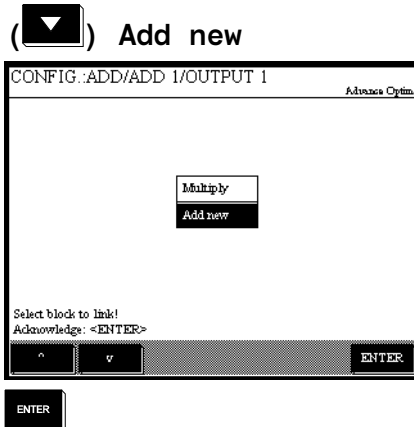

10 Add a new **Multiply** function block :

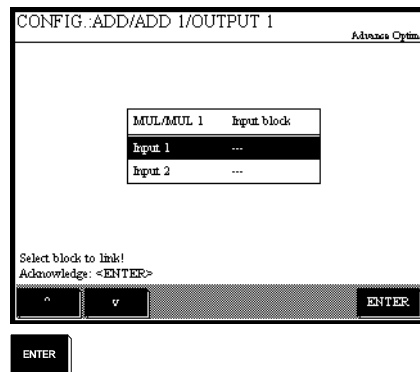

The system generates the 'Mul1' function block.

11 Link 'Mul1' function block Input 1 to 'Add1' function block Output 1:



If Input 1 already shows a link, this link is overwritten and an existing application is deleted when  is pressed! To avoid this, use the  key to cancel configuration and prepare a new plan.

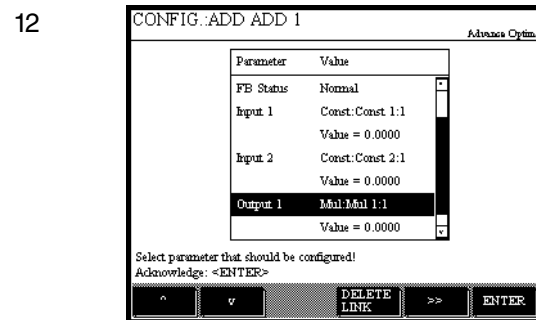

This ends the configuration of links.

Configure the function block parameters

13 Configure the parameters of the 'Add1', 'Const1' and 'Const2' function blocks.

14 End configuration by pressing the  key.

Function Block Overview

Summary

The following function blocks are available:

Miscellaneous	Limit monitor
Inputs	Hold
Outputs	Feedback
Mathematics	Timer
Multiplexer/Demultiplexer	Sequencer
Measurement	Access lock
Sample system	
Calibration/Correction	

Miscellaneous	
Inputs	Digital input
Outputs	Analog input
Mathematics	Message input
Multiplexer/Demultiplexer	Constant
Measurement	
Sample system	
Calibration/Correction	

Miscellaneous	
Inputs	
Outputs	Digital output
Mathematics	Analog output
Multiplexer/Demultiplexer	Message insert
Measurement	
Sample system	
Calibration/Correction	

Miscellaneous	
Inputs	Negate
Outputs	Add
Mathematics	Subtract
Multiplexer/Demultiplexer	Multiply
Measurement	Divide
Sample system	Or
Calibration/Correction	And
	Linear converter

Miscellaneous	
Inputs	
Outputs	Fan
Mathematics	Multiplexer
Multiplexer/Demultiplexer	Demultiplexer
Measurement	Priority encoder
Sample system	Priority decoder
Calibration/Correction	Binary -> Decimal
	Decimal -> Binary

Miscellaneous	Comp. meas. value
Inputs	Det. meas. value
Outputs	Comp. range
Mathematics	Range control
Multiplexer/Demultiplexer	Range feedback
Measurement	Active component MUX
Sample system	
Calibration/Correction	

Miscellaneous	
Inputs	
Outputs	
Mathematics	
Multiplexer/Demultiplexer	
Measurement	
Sample system	Calibration cell
Calibration/Correction	Solenoid
	System pump
	Pump

Miscellaneous	
Inputs	
Outputs	
Mathematics	
Multiplexer/Demultiplexer	Autocal
Measurement	Ext. controlled cal.
Sample system	Cross sens. corr.
Calibration/Correction	Carrier gas corr.

Limit Monitor

Description A function block value, for example, a component measured value is monitored for violations of initialized limits and the result is passed to a digital output.

Parameter

Name	Function	Standard
FB Name	Function block user name	'Limit x'
FB Enable	Activates or deactivates the function block	on
FB Status	Function block status (display only)	ok
Input 1	Component Measured Value function block Displays the input (measurement) value	Standard Assignment
Output 1	Digital Output function block Displays output status	Standard Assignment
Direction	< or > (Alarm on threshold overflow or underflow)	<
Threshold	Threshold in selected unit	0.000
Hysteresis	Hysteresis in selected unit	0.000

Example

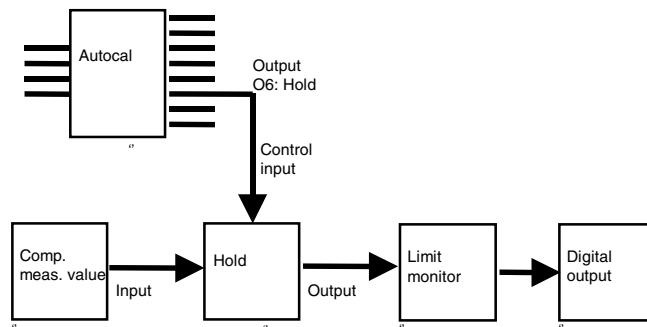

Notes

Normally, Input 1 of a **Limit Monitor** is linked to a **Component Measured Value** in an increasing sequence. Thus, the first **Limit Monitor** in a system is linked to the first **Component Measured Value**, the second **Limit Monitor** to the second **Component Measured Value**, etc.

A **Limit Monitor** and **Component Measured Value** should always be bound to a physical unit (ppm, vol%, etc.).

In software version 1.2 and later, the autocalibration standard configuration incorporates a **Hold** function for the **Component Measured Value**, so that **Limit Monitor** response is suppressed during calibration.

Caution!

In software version 1.1 the link between an **Active Component Multiplexer** and a **Component Measured Value** should not be broken (risk of a system crash).

Limit Monitors added to the standard configuration must be fully configured, i.e. including a **Hold** function.

Hold

Description Depending on the control input, the input value is either routed directly to an output, set to 0 or 1 or the original value is retained.

Parameter	Name	Function	Standard
	FB Name	Function block user name	'Hold x'
	FB Enable	Activates or deactivates the function block	on
	FB Status	Function block status (display only)	ok
	Input 1	Function block with a value to be held (e.g. component measured value) Displays the input value	Standard Assignment with "Component Measured Value x"
	Output 1	Function block with a value to be held (e.g. Analog Output or Limit Monitor for autocalibration) Displays the output value	Standard Assignment with "AO x"
	Control Input	If 0 => Output = Input if 1 => Hold output if 2 => Output = 0 if 3 => Output = 1 if 4 => Output = max. value if 5 => Output = min. value Displays the control input value	
	Unit	Unit of function block linked to Input 1 (can be manually edited)	

Example

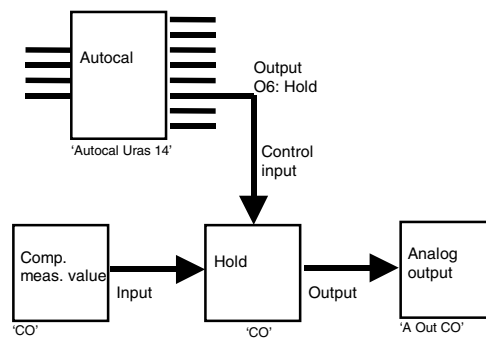

Note Mathematics function blocks (**Or**, **And**) or multiplexers (**Fan**) may be required in the control input.

Feedback

Description

Direct feedback is not possible using the function block architecture. To implement feedback, a **Feedback** function block is provided in software version 1.3 and later.

The output of the **Feedback** function block can be connected to any function block application input. Feedback connections can be established or application segments can be separated from each other. With the built-in FIFO the **Feedback** function block can also be used as a data buffer.

Incoming data are stored in a FIFO element and released to the output, at the earliest, after the preset delay times out. If there are several data items in the FIFO these items are output at equal time intervals, i.e. once an item is output the next item is output after the delay times out.

Parameter

Name	Function	Standard
FB Name	Function block user name	'Feedback x'
FB Enable	Activates or deactivates the function block	on
FB Status	Function block status, displays "ok" or an error number (for maintenance purposes only)	ok
Input 1	Data input	
Output 1	Data output	Standard assignment if selected
Prop. Delay	Delay time	-
FIFO depth	FIFO memory depth (at least 10)	10

Example

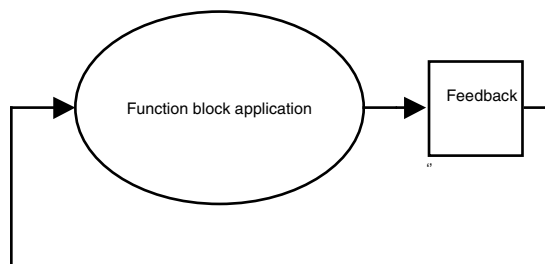

Timer

Description The Timer function block can be used to initiate time-dependent actions.

Note: A high signal at the reset input immediately changes the output to low and stops all delay timers that are running.

Astable Multivibrator Delay time 1 = Periods of high time
Delay time 2 = Periods of low time

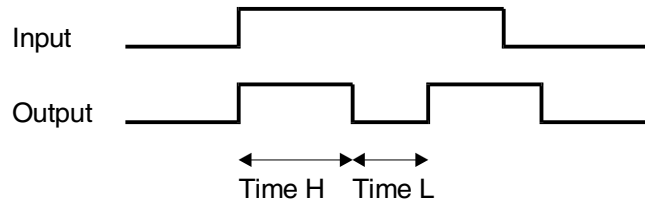

After being enabled (input 1 = high) the multivibrator starts the period with a high interval. A period is always processed to completion. I.e. if the input goes low during a high period, the output will follow only after the high interval has run out.

Monostable Multivibrator Delay time 1 = Dead time
Delay time 2 = Pulse width

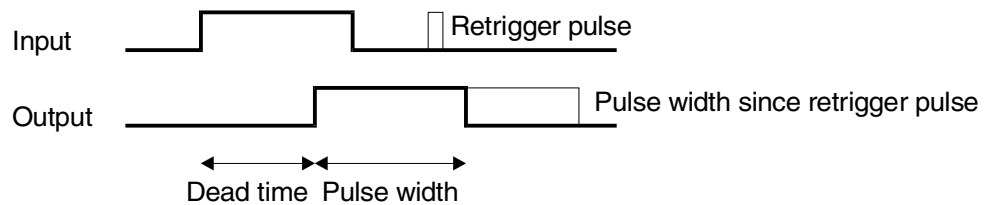

After input 1 goes high, the output remains low during the preset dead time interval. If input 1 returns to low after the dead time interval times out, the cycle ends and the output remains low. Otherwise the output changes to high for the duration of the preset pulse width. In the "monostable retriggerable" mode, a new low-to-high transition at the input during the pulse width will restart the pulse width time and extend the pulse width (watchdog).

Continued on next page

Delay Link

Delay time 1 = Dead time
 Delay time 2 = Pulse width

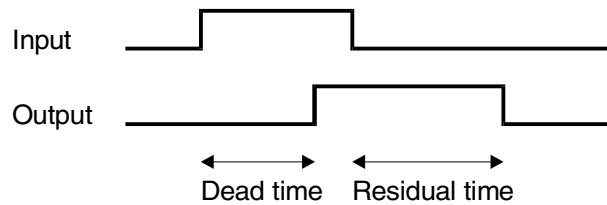

After input 1 goes high, the output remains low during the preset dead time interval. If input 1 returns to low after the dead time interval times out, the cycle ends and the output remains low. Otherwise the output changes to high after the dead time interval times out. When input 1 returns to low the residual timer starts. At the end of the residual time the output changes to low. The cycle begins again if the input goes high again after the residual time runs out.

Parameter

Name	Function	Standard
FB Name	Function block user name	'Clock x'
FB Enable	Activates or deactivates the function block	on
FB Status	Function block status, displays "ok" or an error number (for maintenance purposes only)	ok
I1:Enable	Timer enable (if not switched the timer is enabled)	
I2:Reset	Reset timer (output reset to low)	
Output 1	Data output	Standard assignment if selected
Mode	Selection: Non-retriggerable monostable Retriggerable monostable Delay link Astable	non-retriggerable monostable
Dead time	See Figure	1 second
Pulse width	See Figure	1 second

Sequencer

Description

The **Sequencer** function block allows the programming of output sequences.

Each rising or falling edge at the clock input increments the internal program counter by one and values stored at each program step are released to the outputs. Once the last step is reached the program returns to the first program step after one clock pulse. A low signal at the enable input causes the clock input to have no effect.

A high signal at the reset input automatically places the outputs in the reset step, or if this step is not present, sets them low. The step counter is set at program start time.

The individual program steps are stored in the sequence parameter. The first program step defined is the reset condition (reset step). One of the next program steps should program only those outputs whose values are to change. Outputs not covered by a program step will not be changed.

Any digits are allowed as output values.

Parameter

Name	Function	Standard
FB Name	Function block user name	'Seqncr x'
FB Enable	Activates or deactivates the function block	on
FB Status	Function block status, displays "ok" or an error number (for maintenance purposes only)	ok
Sequence	Sequence entry for outputs 1-8 (see example)	-
Slope	Edge (rising or falling) triggering the transition to the next step.	Rising
Step No.	Display only	
I1: Clock	Clock input (determines sequence triggering)	
I2: Enable	Process control enable	
I3: Reset	Process control reset	
Output 1	Programmed sequence output	
Output 2	Programmed sequence output	
Output 3	Programmed sequence output	
Output 4	Programmed sequence output	
Output 5	Programmed sequence output	
Output 6	Programmed sequence output	
Output 7	Programmed sequence output	
Output 8	Programmed sequence output	

Continued on next page

Example

A 4-bit light sequence from left to right and back again.

R = Reset step

Step	A1	A2	A3	A4	A5	A6	A7	A8
R	0	0	0	0	0	0	0	0
1	1							
2	0	1						
3		0	1					
4			0	1				
5			1	0				
6		1	0					
7	1	0						
8	0							

Access Lock

Description Blocks operation at the device, via the remote HMI or both methods. For example, operation via the remote HMI can be locked out using a digital input (to which a key switch can be connected).

Parameter

Name	Function	Standard
FB Name	Function block user name	'Access lock'
FB Enable	Activates or deactivates the function block	on
FB Status	Function block status (display only)	ok
Input 1	Function block with an output value that blocks or permits operation. Input = 0: Operation blocked Input = 1: Operation enabled Operation is permitted if the input is not linked.	
Output 1	Status output If 0 => Operation blocked If 1 => Operation enabled	
Effect	Establishes which type of operation is blocked or enabled: Local HMI => Operation at analyzer Remote HMIs => Operation with remote HMI All HMIs => Local and remote HMIs	Remote HMIs

Example

Controlling access via a digital input and generation of a message for verification.

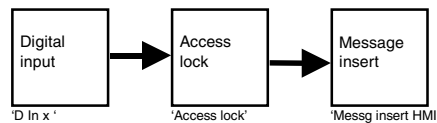

Caution!

Always make sure that you are monitoring the input.

Example: You are operating your unit via a remote HMI and connect a digital output to input 1 of the **Access lock** function block. The digital input contact is open, not inverted and has a value of 0. Your remote HMI is blocked as soon as you confirm the link between the digital input and the **Access lock** function block via the ENTER key. You can no longer operate the unit until you close the contact at the digital input. If the unit is remotely located and you have no access to the digital input you are effectively "locked out".

Similarly, changing the "Effect" parameter can cause a sudden lockout: If you have blocked the remote HMIs and have switched to "Effect on all HMIs", you can no longer operate the unit.

Digital Input

Description Generated according to the available digital input hardware or the virtual modbus DI. The modbus DIs are assigned to virtual units (no hardware is involved) and can only be addressed via the modbus interface.

Parameter	Name	Function	Standard
	FB Name	Function block user name	Per standard arrangement
	FB Enable	Activates or deactivates the function block	on
	FB Value	Current value (display only): "On" or "Off" (Difference between FB Value - FB Status)	Current value
	FB Status	Function block status, displays "ok" or an error number (for maintenance purposes only)	ok
	HW Status	Hardware status, displays "ok" or an error number (for maintenance purposes only) Example: Display "1024" = Configuration of an I/O not available as hardware	ok
	Output 1	Function block controlling this Digital input , e.g. Message Insert or Range control	Per standard arrangement
	DI No. or Address	Number of DI on this board or modbus address	
	Device	Board identification (e.g. SYSCON:SYST.CPU) or any text for modbus DI; currently 'Slave'	-
	Fail Safe	The value to be assumed if the DI fails.	Off
	Invert	Inverts the hardware DI input	No
	Mode	Update operating mode: 'Refresh on value change', 'Query measurement value' or 'Cyclical measurement value refresh'	Refresh on value change
	Dead time	Time during which the input should remain stable in order to be acknowledged as a definite level (bounce avoidance)	0 sec.

Example Switching between measurement ranges 1 and 2 for CO sample component via digital inputs DI 1 and DI 2:

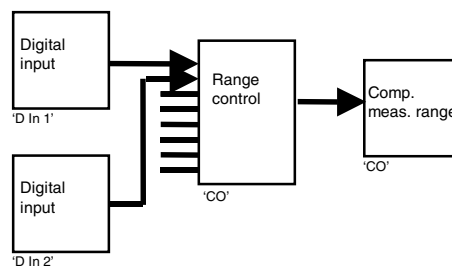

Analog Input

Description Generated according to the available analog input hardware or the virtual modbus AI. The modbus AIs are assigned to virtual units (no hardware is involved) and can only be addressed via the modbus interface.

Parameter	Name	Function	Standard
	FB Name	Function block user name	'I In x'
	FB Enable	Activates or deactivates the function block	on
	FB Value	Current value is displayed	
	FB Status	Function block status, displays "ok" or an error number (for maintenance purposes only)	ok
	HW Status	Hardware status, displays "normal" = ok or an error number (for maintenance purposes only) Example: Display "1024" = Configuration of I/Os not available as hardware	-
	Output 1	Function block to which the Analog input is to be assigned, e.g. Linear converter	
	AI No.	Number of the AI on this board	-
	Device	Board identification (e.g. SYSCON:SYST. CPU)	-
	Fail Safe	The value to be assumed if the AI fails.	0.000 mA
	Measurement Range	Displays the input span	-10 to +10 V -20 to +20 mA
	Mode	Update operating mode: 'Query measurement value' or 'Cyclical measurement value refresh'	Query meas. value
	Cycle Time	'Cyclical measurement value refresh' interval	1.00 sec.
	Resolution	Display only	12 bit

**Example:
Displaying an Outside
Signal on Screen**

Step 1: By default, mA inputs are already linked to a **Linear converter**. The **Linear converter** is preconfigured to show a 4-20 mA input signal as 0-100% span. If a different display is desired, the **Linear converter** must be configured (see Page 42).

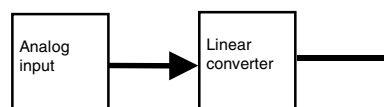

Step 2: In the Config → System → Display menu, select the page on which the measurement value is to be displayed (software version 1.2 and later).

Notes

The **Analog input** function blocks are shown twice in the overview, e.g. as a current input and as a voltage input. Whether the input operates as a current or voltage input is determined by analog input that is subsequently linked to it. Care should be taken to ensure that each analog input is used only once.

Message Input

Description This block is activated selectively via a system message (e.g. maintenance mode, individual error number). Beginning with software version 1.3 system messages can be selectively addressed down to the component level. Thus, for example, status messages can be sent to a DO or an output signal can be used to enable or disable functions within an FB "tree".

Parameter	Name	Function	Standard
	FB Name	Function block user name	'Message Input x'
	FB Enable	Activates or deactivates the function block	on
	FB Value	Corresponds to FB status (0 or 1), depending on whether its specific system message is active or inactive.	-
	FB Status	Function block status (display only)	ok
	Output 1	The function block on which the Message input should act, generally a Digital Output .	Configuration required
	Mode	Selection: 'Activate on selected message no.' 'Activate on error' 'Activate on maintenance required' 'Activate on maintenance mode'	Activate on selected message no.
	Source	Selection: System, module, component	System
	Message No.	If 'activate on selected message no.' is selected as the mode, the number of the status message which is to activate a message should be entered at this point.	0

Example

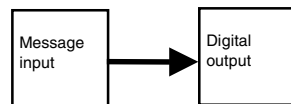

Notes Several **Message inputs** are preconfigured for pump control in the system. These **Message inputs** should not be used for signaling.

Constant

Description The **Constant** function block can, for example, be used on an **Add** FB for adding a constant.

Parameter

Name	Function	Standard
FB Name	Function block user name	'Const x'
FB Enable	Activates or deactivates the function block	on
FB Value	Set constant value	0.0000
FB Status	Function block status (display only)	ok
Output 1	Function block to which the constant is to be linked.	-
Unit	Designation of the unit from the function block connected to the input, editable	-

Example

Adding an offset to a measurement value

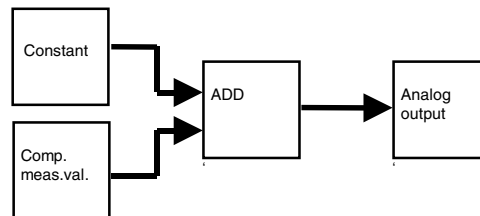

Digital Output

Description Generated according to the available digital output hardware or the virtual modbus DO. The modbus DOs are assigned to virtual units (no hardware is involved) and can only be addressed via the modbus interface.

Parameter	Name	Function	Standard
	FB Name	Function block user name	'D Out x'
	FB Enable	Activates or deactivates the function block	on
	FB Value	Current output value is displayed	-
	FB Status	Function block status, displays "ok" or an error number (for maintenance purposes only)	ok
	HW Status	Hardware status, displays "normal" = ok or an error number (for maintenance purposes only) Example: Display "1024" = Configuration of I/Os not available as hardware	
	Input 1	Function block for which status is to output, e.g. Range feedback or Limit monitor .	Standard assignment if selected
	DO No.	Number of the DO on this board	-
	Device	Board identification (e.g. SYSCON:SYST. CPU)	-
	Output Type	Select "normal" or "pump". By selecting "pump" the output is integrated into the pump control maintenance function. This allows simple operation of an external pump.	Normal
	Fail Safe	The value to be assumed if the DO fails.	Off
	Invert	Inverts the hardware DO input	No

Example

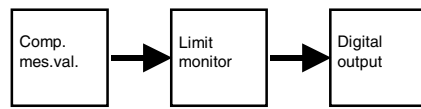

Analog Output

Description Generated according to the available analog output hardware or the virtual modbus AO. The modbus AOs are assigned to virtual units (no hardware is involved) and can only be addressed via the modbus interface.

Parameter	Name	Function	Standard
	FB Name	Function block user name	'A Out x'
	FB Enable	Activates or deactivates the function block	on
	FB Value	Current output value is displayed	-
	FB Status	Function block status, displays "ok" or an error number (for maintenance purposes only)	ok
	HW Status	Hardware status, displays "normal" = ok or an error number (for maintenance purposes only) Example: Display "1024" = Configuration of I/Os not available as hardware Example: Display "4096" = No load on analog output, e.g. line break	-
	Input 1	Function block the value of which is to be output, generally a Component measured value , or a Component measured value via a Hold FB, if the measurement value is to be held during autocalibration.	Standard Assignment
	Output Current Range	0–20, 2–20, 4–20 mA	4-20 mA
	Device	Board identification (e.g. SYSCON:SYST. CPU)	-
	AO No.	Number of the AO on this board	-
	Fail Safe	The value to be assumed if the input fails.	0 mA
	Max. Current Range	Determined by hardware	0-22 mA
	Current Start	User-defined current range	0
	Current End	User-defined current range	22
	Refresh Rate	Determined by I/O, factory-configured	0.5 sec.
	Resolution	Determined by hardware	16 bit

Continued on next page

Example

Analog Output with Hold during autocalibration

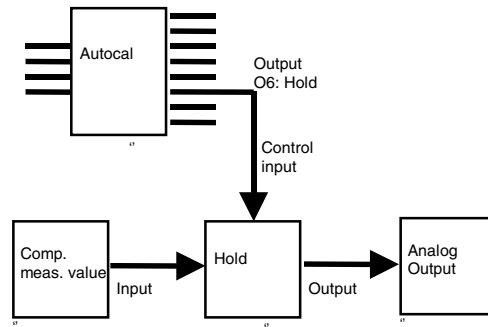

Note

The **Analog output** should always be linked to the **Component measured value** with the % span unit.

Message Insert

Description Used to integrate status signals into system status. The signals can be either external ones supplied via a **Digital input** or system-generated ones, e.g. produced by a **Limit monitor**.

Parameter

Name	Function	Standard
FB Name	Function block user name	'Message Gen x'
FB Enable	Activates or deactivates the function block	on
FB Status	Function block status (display only)	ok
Input 1	Function block with statuses to be incorporated in system status. The standard assignment already incorporates limit monitors with flow monitoring. Other digital inputs	Standard assignment for flow limit monitor
Message No.	The number provides the message with a unique classification in the system. Numbers ≤ 1000 are system messages which only permit limited changes to the parameters shown below.	
Status sig.	Specifies the response of the system when the FB is activated. Values: 'no status signal', 'error', 'maintenance required' or 'maintenance mode'	None
Overall sig.	Incorporated in the overall signal	Off
Confirm.	Specifies how the message is acknowledged	w/out
Log entry	Specifies whether log entry is to be made	No
Message display	Specifies whether the message shall be displayed in the softkey line	Off
Short messg	User-configured message (max. 16 characters)	None
Long messg	User-configured detailed message (max. 46 characters)	None
Module text	Text displayed in the "status messages" overview display. This serves to identify the module that has initiated the status message.	

Example 1

Integration of an external status signal

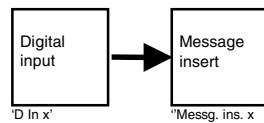

Example 2

Integration a limit monitor with an internal measurement component, e.g. flow

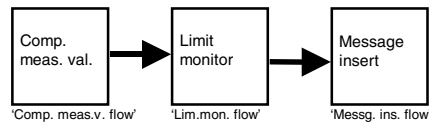

Caution!

The message numbers of different **Message inserts** must be different. Only the parameters of manually generated **Message inserts** can be changed (select using "Add new")

Negate

Description Boolean negation of input.

Parameter

Name	Function	Standard
FB Name	Function block user name	'Neg x'
FB Enable	Activates or deactivates the function block	on
FB Status	Function block status (display only)	ok
Unit	Assumes the unit from block input 1 as soon as a link with another function block takes place. There is no value if no automatic linkage takes place. Can also be edited manually.	
Input 1	Function block with value to be negated	
Output 1	Function block, on which the negated signal is to act	

Add

Description Adds Input 1 and Input 2.

Parameter

Name	Function	Standard
FB Name	Function block user name	'Add x'
FB Enable	Activates or deactivates the function block	on
FB Status	Function block status (display only)	ok
Input 1	Function block with value to be added	
Input 2	Function block with value to be added	
Output 1	The function block which should display the added value, generally an Analog Output	
Unit	Using this unit the added value is displayed on screen	

Example

Adding an offset to a measurement value

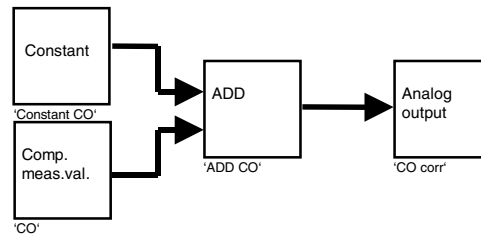

Note

Using **Configure** → **System** → **Display** the added value can also be displayed on screen.

Subtract

Description Subtracts Input 2 from Input 1.

Parameter

Name	Function	Standard
FB Name	Function block user name	'Sub x'
FB Enable	Activates or deactivates the function block	on
FB Status	Function block status (display only)	ok
Input 1	'Input 2' is subtracted from this	
Input 2		
Output 1	The function block which should display the subtracted value, generally an Analog output	
Unit	Using this unit the subtracted value is displayed on screen	

Example

Delta CO measurement

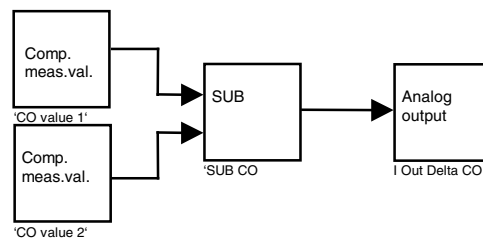

Notes

Using Config → System → Display the subtracted value can also be displayed on screen.

Important: If the **Component Measured Value** is already linked to another function block, e.g. an **Analog Output**, then a **Fan** should be used.

Multiply

Description Multiplies Input 1 by Input 2.

Parameter

Name	Function	Standard
FB Name	Function block user name	'Mul x'
FB Enable	Activates or deactivates the function block	on
FB Status	Function block status (display only)	ok
Input 1	Function block to be multiplied by 'Input 2'	
Input 2	Function block to be multiplied by 'Input 1'	
Output 1	The function block which should display the multiplied value, generally an Analog output	
Unit	Using this unit the multiplied value is displayed on screen	

Example

Conversion of $\text{mg/m}^3 \text{NO}$ to $\text{mg/m}^3 \text{NO}_2$

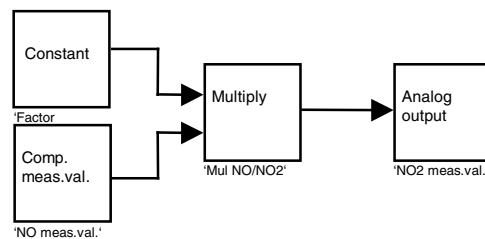

Divide

Description Divides Input 1 by Input 2.

Parameter

Name	Function	Standard
FB Name	Function block user name	'Div x'
FB Enable	Activates or deactivates the function block	on
FB Status	Function block status (display only)	ok
Input 1	Function block to be divided by Input 2	
Input 2	Dividend	
Output 1	The function block which should display the divided value, generally an Analog output	
Unit	Using this unit the divided value is displayed on screen	

Or

Description Boolean OR operation.

Input 1	Input 2	Output
0	0	0
0	1	1
1	0	1
1	1	1

Parameter

Name	Function	Standard
FB Name	Function block user name	'Or x'
FB Enable	Activates or deactivates the function block	on
FB Status	Function block status (display only)	ok
Input 1	See the table	
Input 2	See the table	
Output 1	See the table	

Note An open input is interpreted as a logical 0.

And

Description Boolean AND operation.

Input 1	Input 2	Output
0	0	0
0	1	0
1	0	0
1	1	1

Parameter

Name	Function	Standard
FB Name	Function block user name	'And x'
FB Enable	Activates or deactivates the function block	on
FB Status	Function block status (display only)	ok
Input 1	See the table	
Input 2	See the table	
Output 1	See the table	

Note An open input is interpreted as a logical 1.

Linear Converter

Description The linear converter function block is used to correct values according to the following correction function:
 $Output = Slope \times Input + Offset$

Parameter	Name	Function	Standard
	FB Name	Function block user name	'Linear conv. x'
	FB Enable	Activates or deactivates the function block	on
	FB Status	Function block status (display only)	ok
	Input 1	Function block to undergo linear conversion (e.g. °C → °F or x mg/m ³ NO → y mg/m ³ NO ₂) Displays the input value	Configuration required
	Output 1	e.g. Analog output function block Displays the output value	Configuration required
	Slope	Slope of the linear equation	2.000
	Offset	Offset of the linear equation	0.000
	Unit	Unit of function block linked to Input 1 (can be manually edited)	

Example 1

Output via analog output

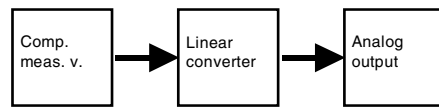

Example 2

Display on screen (only software version 1.2 and later)

- Step 1:

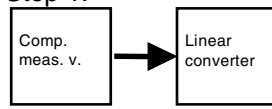

- Step 2

Add the configured linear converter to the desired screen using the Configure → System → Display menu item.

Note

For the component measured value to be output both as a corrected and an uncorrected analog signal, a **Fan** must be added after the **Component measured value**. In this way it is possible to split the signal into an **Analog output** (uncorrected signal) and **Linear converter** (generation of the corrected signal).

Fan

Description 'Multiple' tee for 'fanning out' a value that is to be sent to several FBs.

Parameter

Name	Function	Standard
FB Name	Function block user name	'Fan x'
FB Enable	Activates or deactivates the function block	on
FB Value	Fan value (= Input 1)	
FB Status	Function block status (display only)	ok
Unit	'Input FB' unit is broadcast. Can be manually entered.	
Input 1	Input to be "fanned out".	
Output 1	FB Value	
Output 2	FB Value	
Output 3	FB Value	
Output 4	FB Value	
Output 5	FB Value	
Output 6	FB Value	
Output 7	FB Value	
Output 8	FB Value	

Example

A component measured value is to be displayed for several limit values.

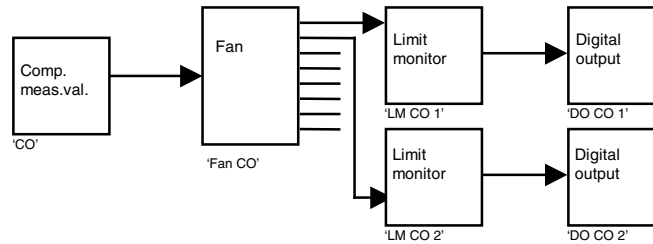

Multiplexer

Description Inputs 1-8 are selectively placed at the output by a control input.

Parameter	Name	Function	Standard
	FB Name	Function block user name	'Mux x'
	FB Enable	Activates or deactivates the function block	on
	FB Status	Function block status (display only)	ok
	Output 1	Input connected through	
	Control Input	Control input that selectively places one of the inputs at the output (digit between 1 and 8)	
	Input 1	Input that can be connected through, depending on control input.	
	Input 2	As above	
	Input 3	As above	
	Input 4	As above	
	Input 5	As above	
	Input 6	As above	
	Input 7	As above	
	Input 8	As above	

Demultiplexer

Description The input is placed at one of the outputs (1-8) by a control input.

Parameter	Name	Function	Standard
	FB Name	Function block user name	'Demux x'
	FB Enable	Activates or deactivates the function block	on
	FB Status	Function block status (display only)	ok
	Input 1	Input that can be connected through to one of the outputs, depending on control input.	
	Control Input	Control input that selectively places the input at one of the outputs (digit between 1 and 8)	
	Output 1	Input connected through or 0	
	Output 2	As above	
	Output 3	As above	
	Output 4	As above	
	Output 5	As above	
	Output 6	As above	
	Output 7	As above	
	Output 8	As above	

Priority Encoder

Description The active input with the highest value (not equal to 0) is sent to the output as a 'real' number.

Parameter

Name	Function	Standard
FB Name	Function block user name	'Pri Encod x'
FB Enable	Activates or deactivates the function block	on
FB Value	Function block value (display only)	
FB Status	Function block status (display only)	ok
Input 1	e.g. Digital Input	
Input 2	e.g. Digital Input	
Input 3	e.g. Digital Input	
Input 4	e.g. Digital Input	
Input 5	e.g. Digital Input	
Input 6	e.g. Digital Input	
Input 7	e.g. Digital Input	
Input 8	e.g. Digital Input	
Output 1	FB Value	

Example

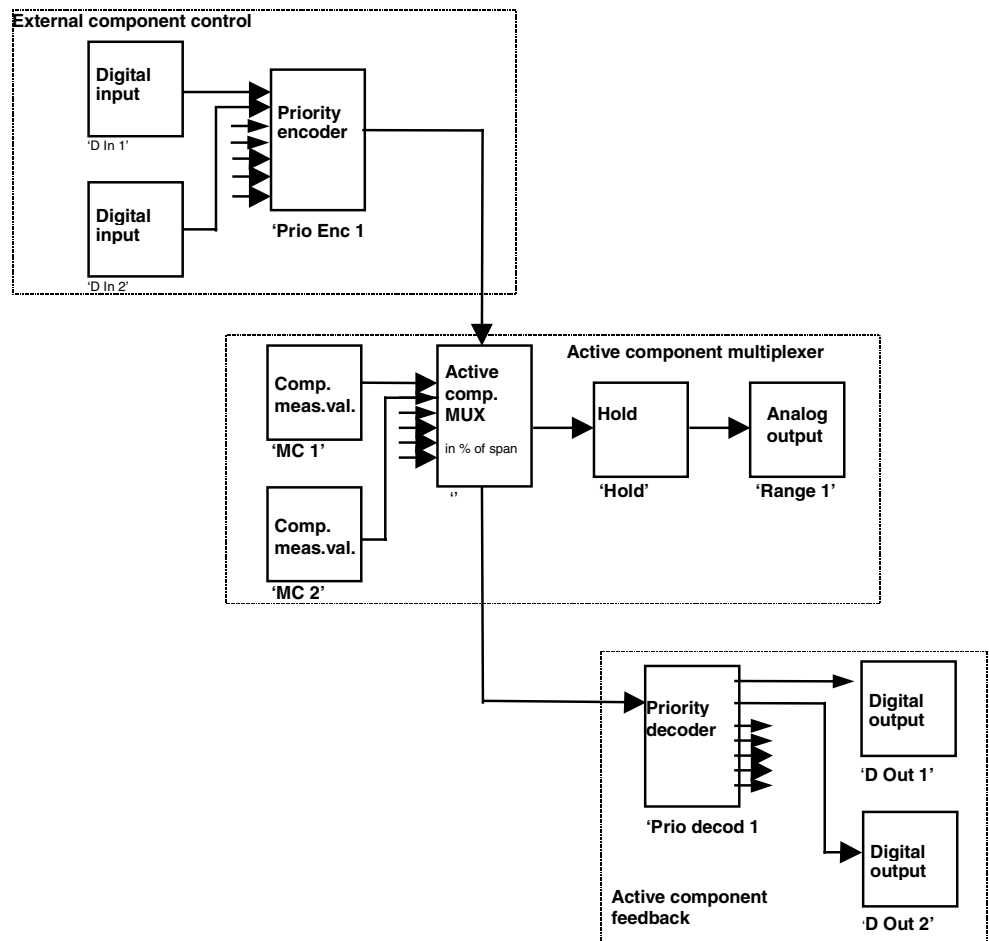

Priority Decoder

Description

A 'real' number at the input is activated as the highest bit at the output.

Example: Input = 7 → output 7 = 1, all other outputs = 0

Parameter

Name	Function	Standard
FB Name	Function block user name	'Pri Decod x'
FB Enable	Activates or deactivates the function block	on
FB Status	Function block status (display only)	ok
Input 1	Input combination to 'investigate'.	
Output 1	e.g. Digital Output	
Output 2	e.g. Digital Output	
Output 3	e.g. Digital Output	
Output 4	e.g. Digital Output	
Output 5	e.g. Digital Output	
Output 6	e.g. Digital Output	
Output 7	e.g. Digital Output	
Output 8	e.g. Digital Output	

Example

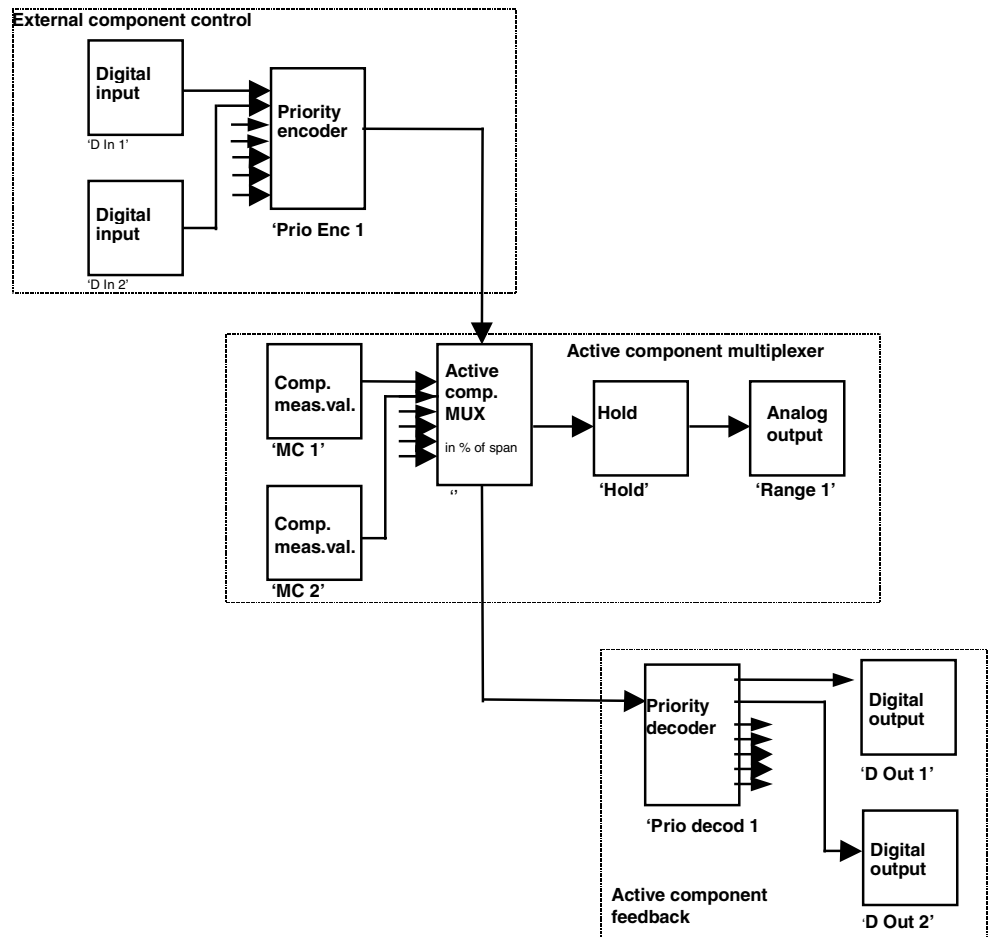

Binary → Decimal

Description

Control input = 0: Inputs 1-8 are expressed as binary values, and sent to the output as a decimal number. Example: 0001 0001 → 17

Control input = 1: Hold output

Control input = 2: Output = 0

Control input = 3: Output = 1

Parameter

Name	Function	Standard
FB Name	Function block user name	'Bin->Dec x'
FB Enable	Activates or deactivates the function block	on
FB Value	Function block value (display only)	
FB Status	Function block status (display only)	ok
Output 1	See description	
Control Input	Control input	
Input 1	See description	
Input 2	See description	
Input 3	See description	
Input 4	See description	
Input 5	See description	
Input 6	See description	
Input 7	See description	
Input 8	See description	

Example

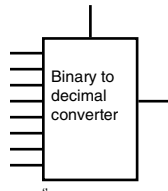

Decimal → Binary

Description

Control input = 0: The input is translated as binary and sent to a decimal value to outputs 1-8. Example: 17 → 0001 0001

Control input = 1: Values at outputs 1-8 are held

Control input = 2: Values at outputs 1-8 are set to 0

Control input = 3: Values at outputs 1-8 are set to 1

Parameter

Name	Function	Standard
FB Name	Function block user name	'Dec->Bin x'
FB Enable	Activates or deactivates the function block	on
FB Status	Function block status (display only)	ok
Input 1	See description	
Control Input	Control input	
Output 1	See description	
Output 2	See description	
Output 3	See description	
Output 4	See description	
Output 5	See description	
Output 6	See description	
Output 7	See description	
Output 8	See description	

Example

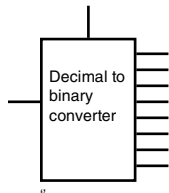

Component Measured Value

Description

This FB is generated automatically according to the analyzer configuration. It corresponds to the analyzer measured value. **Component measured values** are always generated in pairs; once in physical units (for **Limit monitor**) and once in %span (for **Analog output**).

The **Component measured value** FB has no input; it is generated directly by the analyzer module and transferred automatically to this FB.

Parameter

Name	Function	Standard
FB Name	Function block user name	Assigned per analyzer module
FB Enable	Activates or deactivates the function block	on
FB Value	Value of analyzer measured value with corresponding unit	
FB Status	Function block status, displays "ok" or an error number (for maintenance purposes only)	ok
HW Status	Hardware status, displays "normal" = ok or an error number (for maintenance purposes only)	
Output 1	FB value that is to output the Component measured value , generally an Analog output . With the standard assignment a Hold FB is inserted to enable the measured value to be retained during calibration.	Standard Assignment
Device	Analyzer ID, e.g. Uras 14 Analyzer 1. This is a combination of device type and user text (which can be edited with the calibration and test software)	Assigned per analyzer module
Mode	'Query measurement value' or 'Cyclical measurement value refresh'; should not be changed.	'Cyclical measurement value refresh'
Cycle Time	Appears in 'Cyclical measurement value refresh' mode and corresponds to the measurement value refresh time.	
Interval	Appears in 'Query measurement value' mode. Parameter is permanently set to 0.	

Example

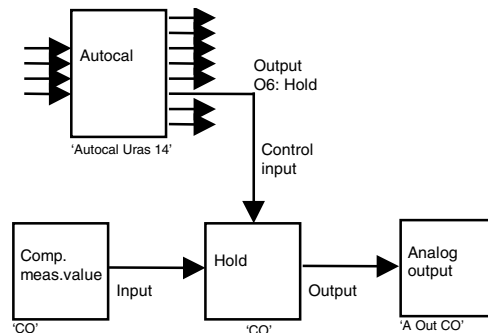

Detector Measured Value

Description

This FB is generated automatically according to the analyzer configuration. The raw measured values from the detectors are displayed.

The **Detector measured value** FB has no input; it is generated directly by the analyzer module and transferred automatically to this FB.

Parameter

Name	Function	Standard
FB Name	Function block user name	Assigned per analyzer module
FB Enable	Activates or deactivates the function block	on
FB Status	Function block status, displays "ok" or an error number (for maintenance purposes only)	ok
HW Status	Hardware status, displays "normal" = ok or an error number (for maintenance purposes only)	
Output 1		
Raw Value	Raw measured value from detector	
Device	Analyzer ID, e.g. Uras 14 Analyzer 1. This is a combination of device type and user text (which can be edited with the test and calibration tool)	
Mode	'Query measurement value' or 'Cyclical measurement value refresh'	'Query meas. value'
Cycle Time	Appears in 'Cyclical measurement value refresh' mode and corresponds to the measurement value refresh time.	
Interval	Appears in 'Query measurement value' mode. Parameter is permanently set to 0.	

Example

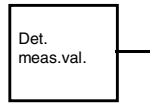

Component Range

Description This FB is generated automatically according to the analyzer configuration. The **Component measured value** measurement ranges are displayed.

The **Component range** FB has no input; it is generated directly by the analyzer module and transferred automatically to this FB.

Parameter

Name	Function	Standard
FB Name	Function block user name	Assigned per Analyzer → 'Comp. Meas. Comp. Name'
FB Enable	Activates or deactivates the function block	on
FB Value	Active measurement range or 'Range Error' in case of error	Measurement Range 1
FB Status	Function block status, displays "ok" or an error number (for maintenance purposes only)	ok
Input 1	Input for switching between the various measuring ranges, generally linked with a Range Control FB.	Standard Assignment
Output 1	Output for active measurement range feedback, generally linked to a Range Feedback FB	
Device	Analyzer ID, e.g. Uras 14 Analyzer 1. This is a combination of device type and user text (which can be edited with the test and calibration tool)	

Example

External measurement range switching with feedback

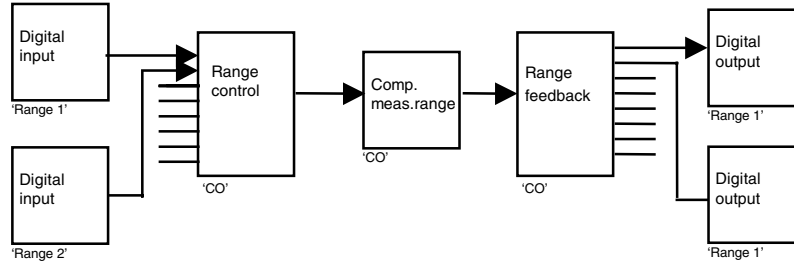

Range Control

Description

The **Range Control** function block is used for externally controlled range switching, e.g. via **Digital inputs**.

Depending on the mode of operation specified through parameters

- either the highest-value digital input is sent to the output as a number (priority-encoded). For example: **DI 2** (0000 0011) activates measurement range **2**
- or the inputs are interpreted as binary numbers and are sent accordingly to the output (binary - decimal conversion). For example: **DI 1** and **DI 2** (0000 0011) activates measurement range **3**.

Parameter

Name	Function	Standard
FB Name	Function block user name	'Meas Range Switching x'
FB Enable	Activates or deactivates the function block	on
FB Status	Function block status (display only)	ok
Output 1	Controls the required measurement range in the Component range function block	Configuration required
Input 1	Digital input function block	Standard assignment with digital I/O board in slot 3
Input 2	Digital input function block	See Input 1
Input 3	Digital input function block	See Input 1
Input 4	Digital input function block	See Input 1
Input 5		
Input 6		
Input 7		
Input 8		
Operation	Binary-decimal conversion or priority-encoded	Priority-encoded

Example

Switching between measurement ranges 1 and 2 for CO sample component via digital inputs DI 1 and DI 2:

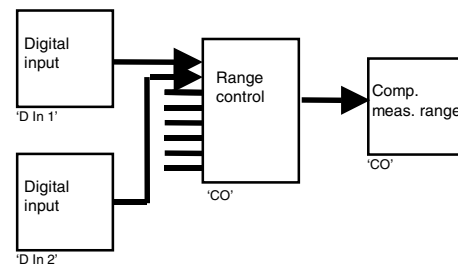

Range Feedback

Description

The **Range feedback** function block is used to report the measurement range in use, e.g. via **Digital outputs**.

Depending on the mode of operation specified through parameters

- either the active measurement range is sent to the output as a number (priority-encoded). For example: Measurement Range 2 activates **Digital output 2** (0000 0010)
- or the active measurement range is interpreted as a binary number and is sent to the output (binary - decimal conversion). For example: Measurement range 3 activates **DI 1** and **DI 2** (0000 0011).

Parameter

Name	Function	Standard
FB Name	Function block user name	'Range Feedback x'
FB Enable	Activates or deactivates the function block	on
FB Value	Function block value (display only)	0
FB Status	Function block status (display only)	ok
Input 1	Transfer of active measurement range from Component range function block	Configuration required
Output 1	Digital output function block	Standard assignment with digital I/O board in slot 3
Output 2	Digital output function block	See above
Output 3	Digital output function block	See above
Output 4	Digital output function block	See above
Output 5		
Output 6		
Output 7		
Output 8		
Operation	Decimal-binary conversion or priority-decoded	Priority-decoded

Example

Feeds back the active measurement range for component CO via digital outputs DO 1 and DO 2:

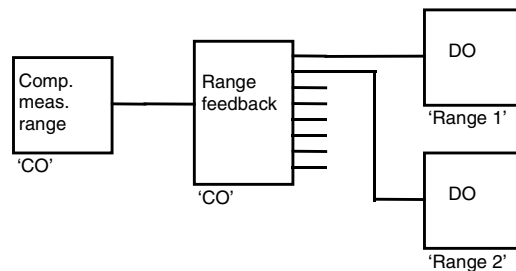

Active Component Multiplexer

Description

The output of this FB always contains the value of the active component (which must be linked to the inputs in the form of FBs). This FB is only relevant to analyzers capable of measuring several components with the same detector (e.g. Caldos 17).

Depending on the number of **Analog outputs** available, the **Component measured values** are already linked with an **Active Component MUX** both as a physical unit (e.g. ppm or Vol%) as well as % span in the standard configuration. Control of the active component occurs in the same way as control of measurement range through the HMI in menu item **Configure** → **Component-Specific** → **Active Component**. Additional control inputs and outputs can be used for external component switching or feedback (as for range switching or feedback).

The **Component measured values** linked with the inputs are sent to the output in accordance with the control input (the output, in turn, can be linked to an **Analog output** FB via a **Hold** FB). The control input is interpreted as a 'real' number (= priority-encoded). The lowest-numbered inputs must be connected first (input 1 first, followed by input 2, etc.).

The component selected as active is displayed (as a 'real' number) via the 'Feedb.' output. This output can be used to feedback the selected component.

Caution!

In software version 1.1 no other FB should be used between the **Comp. meas. value** (phys. or %span) FB and the **Active Component MUX** FB.

In software version 1.3.2 and later no FB **Feedback** should be used between the **Comp. meas. value** (phys. or %span) FB and the **Active Component MUX** FB.

Parameter

Name	Function	Standard
FB Name	Active component name	'CompMux x'
FB Enable	Activates or deactivates the function block	on
FB Status	Function block status (display only)	ok
Output 1	Value of selected input	
Input 1	Sample component → Comp. Value FB or empty	
Input 2	Sample component → Comp. Value FB or empty	
Input 3	Sample component → Comp. Value FB or empty	
Input 4	Sample component → Comp. Value FB or empty	
Input 5	Sample component → Comp. Value FB or empty	
Input 6	Sample component → Comp. Value FB or empty	
Input 7	Sample component → Comp. Value FB or empty	
Control Input	Optional: 'Real' number for selecting an input to be sent to the output (e.g. for implementing external component selection)	
Feedback	Optional: Represents the component currently selected (can be used to feedback the active component via DOs)	
Unit	Preset with the measurement component unit. Can be edited if no useful unit is available at the inputs.	

Continued on next page

Example

The example shows an **Active Component MUX** including external switching and active component feedback.

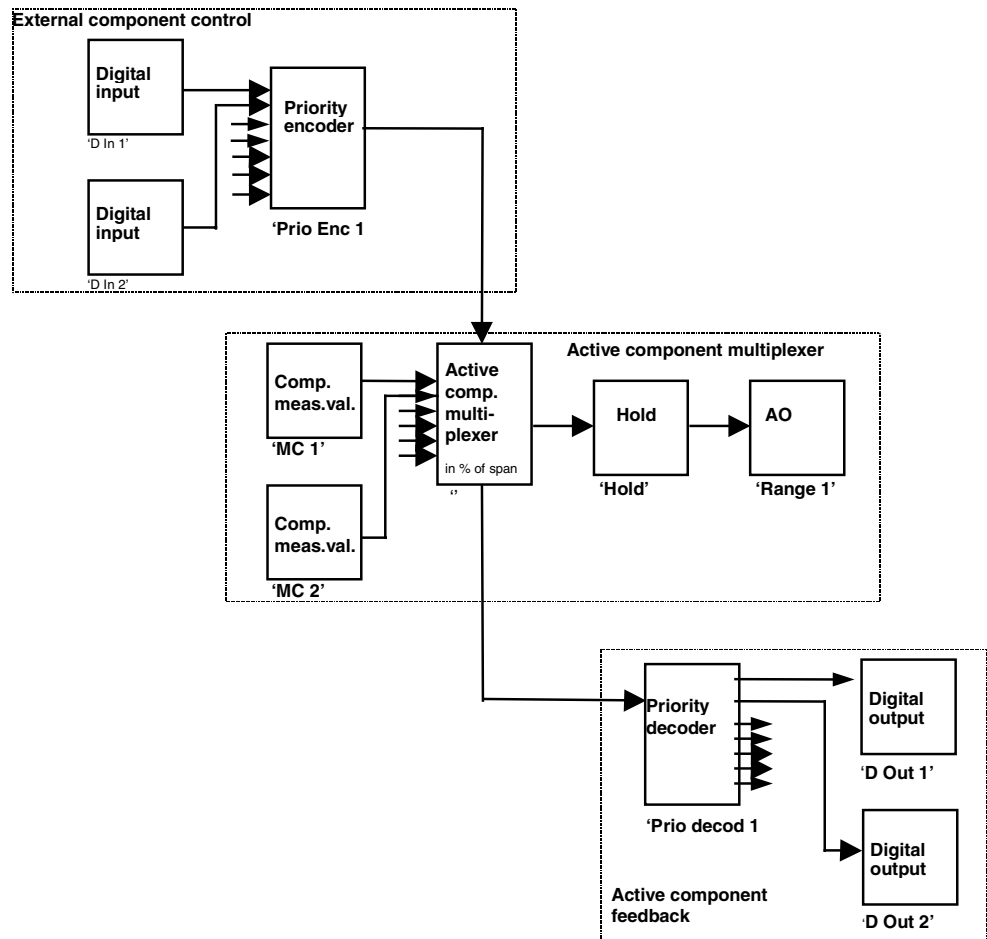

Calibration Cell

Description This FB controls a Uras 14 analyzer module calibration cell.

Parameter	Name	Function	Standard
	FB Name	Function block user name	'Cal. Cell n'
	FB Enable	Activates or deactivates the function block	on
	FB Value	Shows the position of the calibration cell: out = 'out' position, in = 'in' position	
	FB Status	Function block status, displays "ok" or an error number (for maintenance purposes only)	ok
	HW Status	Hardware status, displays "normal" = ok or an error number (for maintenance purposes only)	Normal
	Input 1	Input for controlling the calibration cell	Standard Assignment
	Cal. Cell No.	Sequential number of installed calibration cells	'n'

Example See Autocalibration

Solenoids

Description This FB controls the solenoids in an internal gas module.

Parameter	Name	Function	Standard
	FB Name	Function block user name	'Sample Gas', 'Zero Gas' or 'Det. Gas'
	FB Enable	Activates or deactivates the function block	on
	FB Value	Shows the position of the solenoids: off = off, on = on	
	FB Status	Function block status, displays "ok" or an error number (for maintenance purposes only)	ok
	HW Status	Hardware status, displays "normal" = ok or an error number (for maintenance purposes only)	Normal
	Input 1	Input for controlling the solenoids	Standard Assignment
	Solenoid No.	Sequential number of installed solenoids	'n'
	Device	Analyzer ID, e.g. Uras 14 Analyzer 1. This is a combination of device type and user text (which can be edited with the test and calibration tool).	
	Fail Safe	The value to be assumed if the input fails.	

Example See Autocalibration

System Pump

Description This FB describes the response of an internal pump or a DO for controlling an external pump when autocalibration is not running.

Parameter	Name	Function	Standard
	FB Name	Function block user name	
	FB Enable	Activates or deactivates the function block	on
	FB Value	Shows the pump setting: 'off' or 'on'	on
	FB Status	FB status	ok
	Output 1		

Example See Autocalibration

Pump

Description This FB controls the internal pump or a DO controlling an external pump.

Parameter	Name	Function	Standard
	FB Name	Function block user name	'Pump'
	FB Enable	Activates or deactivates the function block	on
	FB Status	Function block status, displays "ok" or an error number (for maintenance purposes only)	ok
	HW Status	Hardware status, displays "normal" = ok or an error number (for maintenance purposes only)	Normal
	Mode	on/manual on = the values provided by inputs 1 and 2 control the pump. If input 1 or 2 is not linked to a function block, then as an alternative the values of 'manual active' are used for input 1 and 'manual power' for input 2 manual = the values stipulated in 'manual active' and 'manual power' are used for controlling the pump	on
	Input 1: on/off	Linked to autocalibration	
	Input 2: Power	Can be used for external power control of a pump, e.g. via an analog input	
	Manual on	Activates the manual setting for pump operation: 'off' or 'on'; Refer to Mode.	
	Manual Power	Power expressed in %, refer to Mode	'50 %'
	Device	Analyzer ID, e.g. Uras 14 Analyzer 1. This is a combination of device type and user text (which can be edited with the test and calibration tool).	
	Fail Safe	The value to be assumed if the input fails.	'0.000 %'

Example See Autocalibration

Autocalibration

Description The **Autocalibration** function block is generated automatically when a system is booted for the first time (one **Autocalibration** per analyzer), and, depending on the hardware available (DIs, DOs, pump, internal solenoids), is linked to other function blocks.

Parameter	Name	Function	Standard
	FB Name	Function block user name	'Device type'
	FB Enable	Activates or deactivates the function block	on
	FB Status	Function block status (display only)	ok
	I1: Start	Input signal (Digital input) triggers an automatic calibration	Standard Assignment
	I2: Cancel	Input signal (Digital input) cancels a calibration in progress	Configuration required
	I3: Disable	Input signal (Digital input) disables automatic calibration (but does not cancel calibration in progress)	Standard Assignment
	O1: Prewarn	Output signal is active (=1) 5 seconds prior to the start of automatic calibration	Configuration required
	O2: Sample Gas	Output signal controls a 3/2-way solenoid (via a Digital output) to switch between sample gas and test gas	Standard Assignment
	O3: Zero Gas	Output signal controls a 3/2-way solenoid (via a Digital output) to switch between sample gas, zero gas and tail gas	Standard assignment with digital I/O board in slot 5
	O4: Tail Gas	Output signal controls a 3/2-way solenoid (via a Digital output) to switch between sample gas, zero gas and tail gas	Standard assignment with digital I/O board in slot 5
	O5: Pump	Output signal controls an external pump (on/off) (via a Digital output)	Standard Assignment with Applicable I/O Board
	O6: Hold	Output signal affects output current response during automatic calibration	Standard Assignment
	O7: Status	Output signal is active (=1) during the entire automatic calibration process	Standard Assignment
	O8: Sol. Control	Affects the response of solenoids during automatic calibration (software version 1.2 and later)	Standard Assignment

Note A function block must be connected to each solenoid control output. Otherwise the function block **Autocalibration** will not work.

Continued on next page

Example

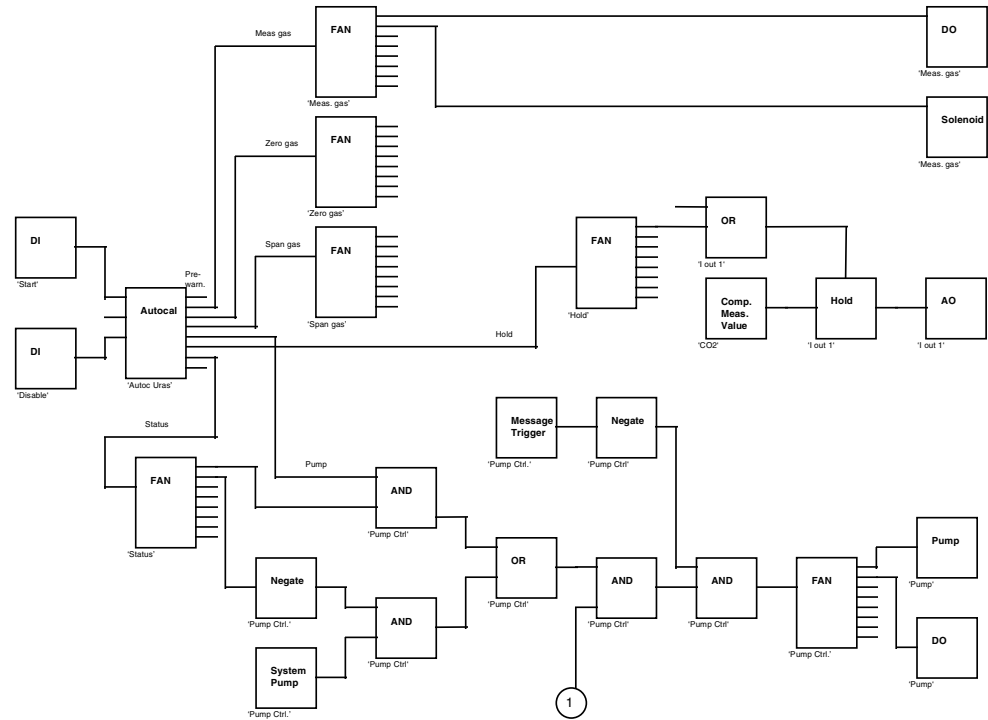

Externally Controlled Calibration

Description

The **Externally controlled calibration** FB can be used, for example, to perform a calibration via **Digital inputs**. Gas activation, calibration cell movement and subsequent waiting for a stable measured value is then performed externally, e.g. via a PLC.

With the Uras 14, when the calibration cell is inserted the calibration cell gas concentration values stored in the device are used for correcting the calibration. Insertion of the calibration cell should also be controlled via a **Digital input**.

Parameter

Name	Function	Standard
FB Name	Function block user name	'xx Device Type' with ZP for Zero and EP for End
FB Enable	Activates or deactivates the function block	on
FB Status	Function block status (display only)	ok
Input 1	Input signal (Digital input) triggers external calibration Displays the input value	Standard Assignment
Calibration Data	Access to the parameters for calibration method, calculation method, test gas concentration and calibration components (see below)	
Calibration Method	Standard gas, substitute gas or common calibration	Common calibration (substitute gas calibration, if available)
Calculation Method	Calculation as offset calibration, amplification calibration, or offset and amplification calibration	Offset
Test Gas Concentration	Changing the test gas concentrations for all measurement components	Measurement Range Limits
Components for Calibration	When the FB is created automatically (after an analyzer module has been added), all measurement components are chosen for externally controlled calibration. When the calibration method is switched to common calibration, the required measurement components must be selected manually.	All sample components

Cross-Sensitivity Correction

Description A **Cross sensitivity correction** function block is automatically established for each correction block configured in the analyzer module. Cross-sensitivity correction is an offset correction of the measurement signal. The corrected measurement value is displayed on the screen and is output as a corrected mA signal.

Parameter	Name	Function	Standard
	FB Name	Function block user name, standard is X equal to the name of the sample component to be corrected	'X'
	FB Enable	Activates or deactivates the function block	on
	FB Status	Function block status, displays "ok" or an error number (for maintenance purposes only)	ok
	Input 1	Correction value input, e.g. an Advance Optima sample value or an analog input can be used.	
	Device	Analyzer ID, e.g. Uras 14 Analyzer 1. This is a combination of device type and user text (which can be edited with the test and calibration tool)	

**Example 1:
CS Correction
Incorporating
Correction Value via
Analog Input**

By default, mA inputs are already linked to a **Linear converter**. The **Linear converter** is preconfigured to show a 4-20 mA input signal as 0-100% span. If a different display is desired, the **Linear converter** must be configured.

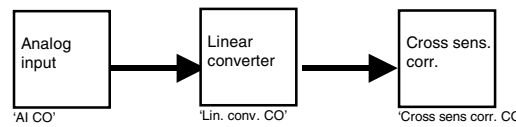

**Example 2:
Sample Value Already
in AO System**

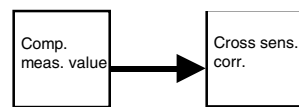

Notes

A cross-sensitivity correction can only be performed if this capability was setup in the analyzer module per customer order.

In an analyzer system with multiple components, cross-sensitivity correction is quite simple since the **Comp. meas. value** FB can be directly linked to **Cross sens. corr.** FB.

Carrier Gas Correction

Description A **Carrier gas correction** function block is automatically established for each correction block configured in the analyzer module. Carrier gas correction is an amplification correction of the measurement signal. The corrected measurement value is displayed on the screen and is output as a corrected mA signal.

Parameter

Name	Function	Standard
FB Name	Function block user name, standard is X equal to the name of the sample component to be corrected	'X'
FB Enable	Activates or deactivates the function block	on
FB Status	Function block status, displays "ok" or an error number (for maintenance purposes only)	ok
Input 1	Correction value input, e.g. an Advance Optima sample value or an analog input can be used.	
Device	Analyzer ID, e.g. Uras 14 Analyzer 1. This is a combination of device type and user text (which can be edited with the test and calibration tool)	

**Example 1:
Carrier Gas Correction
Incorporating
Correction Value via
Analog Input**

By default, mA inputs are already linked to a **Linear Converter**. The **Linear Converter** is preconfigured to show a 4-20 mA input signal as 0-100% span. If a different display is desired, the **Linear Converter** must be configured.

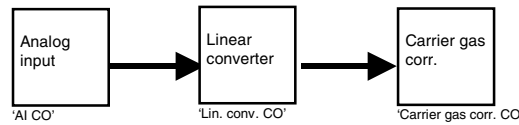

**Example 2:
Sample Value Already
in AO System**

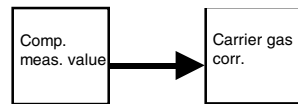

Notes

A carrier gas correction can only be performed if this capability was setup in the analyzer module per customer order.

In an analyzer system with multiple components, carrier gas correction is quite simple since the **Comp. measured value** FB can be directly linked to **Carrier gas corr.** FB.



ABB Automation Products GmbH
Hartmann & Braun Analytical

Stierstaedter Strasse 5, D-60488 Frankfurt am Main, <http://www.abb.com/automation>
Phone +49-6196-800-0, Fax +49-6196-800-4566

Subject to technical changes
Printed in the Fed. Rep. of Germany
30/24-200-2 EN 03.00