

# CE5-...D.., CE5-...W..

1SBC101013M5501-01/16

Auxiliary contacts

Hilfsschalter

Contacts auxiliaires

Kontaktblock

Contatti ausiliari

Contactos auxiliares

Apukosketinlohkot

辅助触点

ДОПОЛНИТЕЛЬНЫЕ КОНТАКТЫ

Operating instructions

Betriebsanleitung

Notice d'instruction

Instruktion

Istruzioni tecniche

Instrucciones de empleo

Ohje

操作说明

Инструкция по эксплуатации

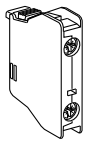

CE5-10D2 ; CE5-01D2  
CE5-10D0, 1 ; CE5-01D0, 1  
CE5-10W2 ; CE5-01W2  
CE5-10W0, 1 ; CE5-01W0, 1

NF... AF09...96  
N...NE...  
A/AE/TAE9...110  
AE/AF45...110  
NL...AL9...40  
TNL...TAL9...40

E1702D

CE5-...	M 3,5 1 N.m	Ø 5,5	pozdriv N°2	2 x 1...4	2 x 0,75...2,5	2 x 0,75...2,5	L < 7,7 mm

E2794D

Assembly - Anbau - Montage - Montering - Montaggio - Montaje - 安装 - Монтаж

Disassembly - Abbau - Démontage  
Demontering - Smontaggio - Desmontaje  
拆卸 - Демонтаж

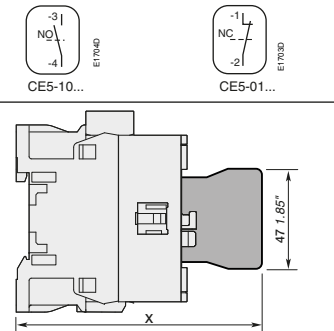
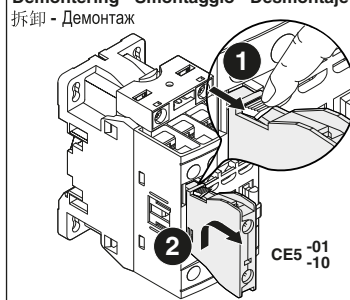
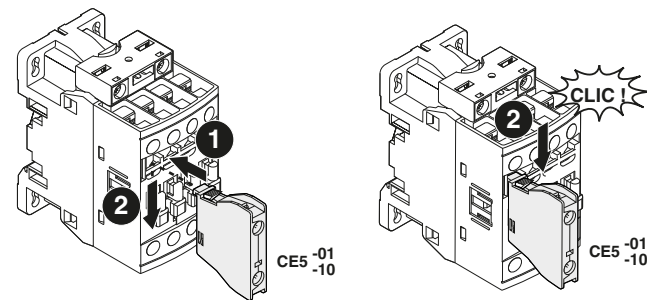

AF09(Z)...16(Z)-30-01  
AF09(Z)...16(Z)-30-10  
AF09(Z)...16(Z)-40-00  
AF09(Z)...16(Z)-22-00  
NF(Z)22E...40E

AF26(Z)...38(Z)-30-00

AF26(Z)...38(Z)-40-00  
AF26(Z)...38(Z)-22-00

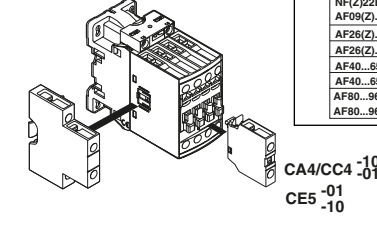
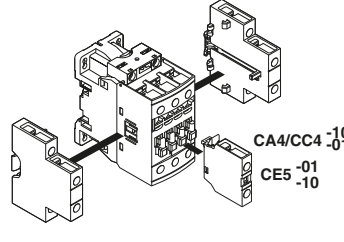
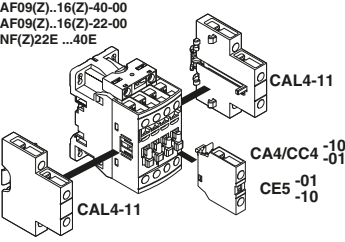

	X mm inch
NF(Z)22E...NF(Z)40E	103,5 4.07"
AF09(Z)...16(Z)	112,5 4.43"
AF26(Z)...38(Z) 3-pole	127,5 5.02"
AF26(Z)...38(Z) 4-pole	137 5.39"
AF40...65 3-pole	140 5.51"
AF40...65 4-pole	142 5.59"

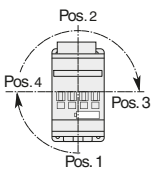

NF(Z)40E  
AF09(Z)...16(Z)-30-10  
AF09(Z)...16(Z)-40-00  
AF26(Z)...38(Z)-30-00  
+ 1 x CE5-10/01 + max 5 aux contacts / 2NC  
+ 2 x CE5-10/01 + max 2 x CA4/CC4-01  
CAL4-11 CA/CC4-01

AF09(Z)...16(Z)-30-01  
AF26(Z)...38(Z)-40-00  
AF09(Z)...38(Z)-22-00  
NF(Z)31E, NF(Z)22E  
+ 1 x CE5-10/01 + max 5 aux contacts / 1NC

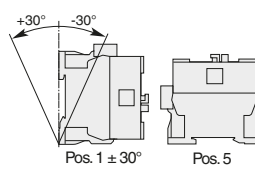

NF(Z)40E  
AF09(Z)...16(Z)-30-10  
AF09(Z)...16(Z)-40-00  
AF26(Z)...38(Z)-30-00  
+ 1 x CE5-10/01 + max 5 aux contacts / 1NC

NF(Z)31E, NF(Z)22E  
AF09(Z)...16(Z)-30-01  
AF26(Z)...38(Z)-40-00  
AF09(Z)...38(Z)-22-00  
+ 1 x CE5-10/01 + max 3 x CA4/CC4-01  
CA/CC4-01 CAL4-11

AF40...65-30-00  
AF80...96-30-00

AF40...65-30-11  
AF80...96-30-11

AF40...80-40-00

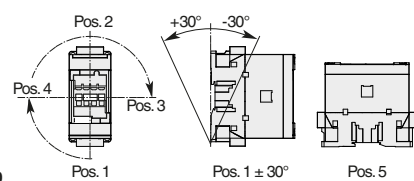
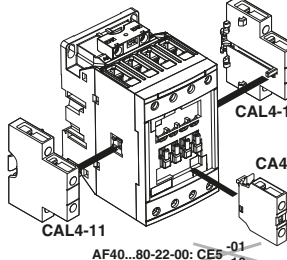
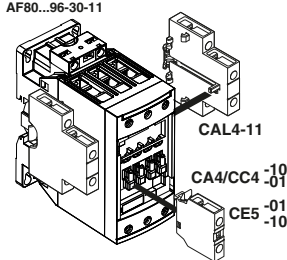
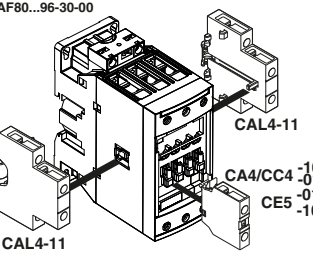

AF40...65-30-00 + 1 x CE5-10/01 + max 7 aux contacts / 4NC  
AF40...80-40-00 + 2 x CE5-10/01 + max 6 aux contacts / 2NC

AF40...65-30-11 + 1 x CE5-10/01 + max 5 aux contacts / 3NC  
AF80...96-30-11 + 2 x CE5-10/01 + max 4 aux contacts / 1NC



**Warning ! Hazardous voltage !** The operation, installation and servicing of this appliance must be carried out by a qualified electrician applying the relevant rules of the art, Installation standards and safety regulations. Do not touch live parts. Danger !



**Warnung ! Gefährliche Spannung!** Die Inbetriebnahme und die Installation des vorhandenen Gerätes sowie jegliche Wartungsarbeiten müssen durch einen Fachelektriker, der die anerkannten technischen Regeln, die Montagenormen und die Sicherheitsvorschriften beachtet, durchgeführt werden. Spannung führende Teile nicht berühren. Lebensgefahr !



**Avertissement ! Tension électrique dangereuse !** La mise en œuvre, l'installation de cet appareil et toute intervention doivent être effectuées par un électricien professionnel appliquant les règles de l'art, les normes d'installation et les règlements de sécurité. Ne pas toucher les pièces sous tension. Danger de mort !



**Varning ! Farlig spänning !** Igångsättning och installation av apparaten samt alla ingrepp bör utföras av en kompetent elektriker enligt gällande installationsnormer och säkerhetsregler. Beröring av spänningsförande delar är förenat med livsfara !



**Avvertenza ! Tensione pericolosa!** La messa in opera, l'installazione di questo apparecchio ed ogni tipo di intervento devono essere effettuati da un elettricista professionista il quale applichi le regole del mestiere, le norme di installazione ed i regolamenti di sicurezza. Non toccare le parti attive. Pericolo di vita !

**¡ Advertencia !** ¡ Tensión peligrosa ! La puesta en aplicación, la instalación de este aparato y cualquier intervención deben realizarse por un electricista profesional que aplique las reglas del oficio, las normas de instalaciones y la reglamentación de seguridad. Las partes bajo tensión no deben tocarse. Peligro de muerte !

**警告 ! 电压危险 !** 产品安装、操作、维修必须由具备资质的专业电工遵照相关制度、法规、安装标准及安全规范完成。务必不要触及带电部件。危险 !

**ОСТОРОЖНО! Опасное напряжение!** Ввод в эксплуатацию, обслуживание и сервисные работы на оборудовании должны производиться квалифицированным персоналом в соответствии с национальными стандартами и требованиями безопасности. Не дотрагивайтесь до токоведущих частей. Опасно!

ABB France

3, rue Jean Perrin  
69680 Chassieu / France  
www.abb.com/lowvoltage



**A/AE9...26, N/NE**

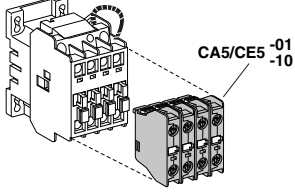

Pos. 1, 2, 3, 4, 1 ± 30°

A26-40-00 { CE5-01 + CA5-01 = 3 max. + CA5-10

A9...26-22-00 } CE5-01 = 1 max. + CA5-10  
N22E, NE12E

N31E, N40E }  
A9...26-30-10 } CE5-01 + CA5-01 = 2 max. + CA5-10  
A9...26-30-01 }  
A9...16-40-00 }  
NE21E, NE30E }  
(T)AE9...26-30-00 }

Pos. 5: ~~CE5~~

**A/AE30, A/AE40**

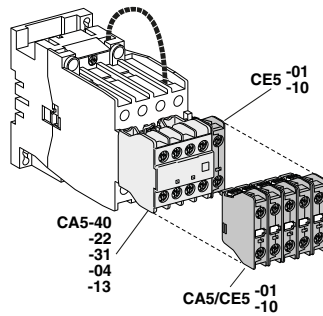

Pos. 1, 2, 3, 4, 1 ± 30°

A30/A40-30-10 } CE5-01 + CA5-01 = 3 max. + CA5-10  
A30/A40-30-01 } CA5-04/13 + ~~CE5~~ + CA5-10  
AE30/AE40-30-00 } CA5-40/22/31 + 1 CE5

Pos. 5: ~~CE5~~

**A30-30-32  
A40-30-32**

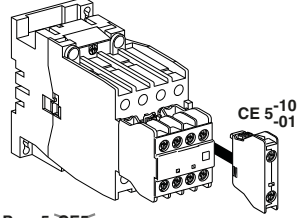

Pos. 5: ~~CE5~~

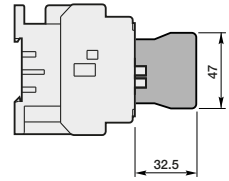

N(E)... + CE5-...  
A(E)9...40 + CE5-...

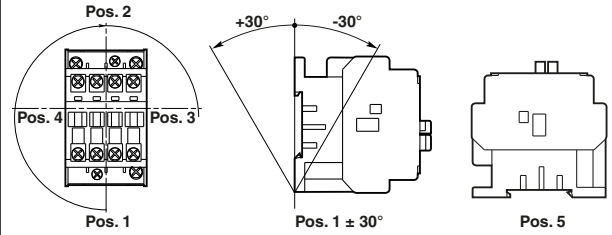

**A/AE/AF/TAE50...110-30-...**

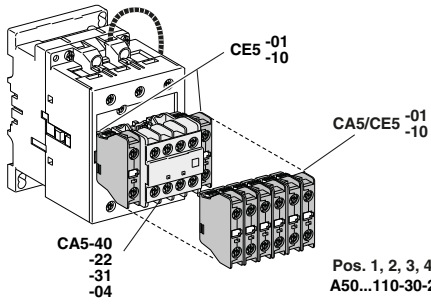

Pos. 1, 2, 3, 4, 5, 1 ± 30°  
A50...110-30-22 : + 2 CE5 max.

A/AF50...110-30-00 } CA5-04 + 1 CE5  
-11 } CA5-40/22/31 + 2 CE5  
(T)AE50...110-30-00 } CE5-01 + CA5-01 = 5 max. + CA5-10  
-11 }

**A/AE/AF/TAE45...175-40  
A/AE/AF45...75-22**

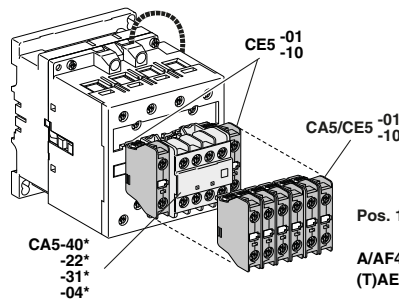

Pos. 1, 2, 3, 4, 5, 1 ± 30°

A/AF45...75-40-00 } CA5-04 + 1 CE5  
(T)AE45...75-40-00 } CA5-40/22/31 + 2 CE5  
CE5-01 + CA5-01 = 5 max. + CA5-10

A/AE/AF45-22-00 } ~~CE5-01~~  
A/AE/AF75-22-00 } ~~CE5-10~~

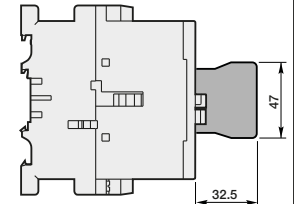

A/AE/TAE/AF45...75 + CE5-...

**(T)AL9...16  
(T)NL**

(T)AL9...16-30-01  
(T)AL9...16-30-10  
(T)AL9/16-40-00  
(T)AL9/16-22-00\*  
(T)NL40E  
(T)NL31E  
(T)NL22E\*

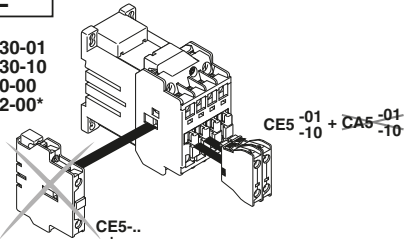

\* (T)AL9...16-22-00 } CE5  
\* (T)NL22E }

Pos. 1, 2, 3, 4, 1 ± 30°

Pos. 5: ~~CE5~~

(T)AL9...16-30-10 } max. 2 CE5-01  
(T)AL9...16-30-01 }  
(T)AL9...16-40-00 }

**AL9Z...16Z  
NLZ**

AL9Z...16Z-30-10  
AL9Z...16Z-30-01  
NLZ22E\*...NLZ40E

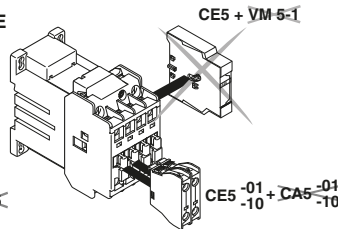

\*NLZ22E : ~~CE5~~

Pos. 1, 2, 3, 4

Pos. 1 ± 30°

(T)AL9Z...16Z-30-10 } max. 2 CE5-01  
(T)AL9Z...16Z-30-01 }  
NLZ31E, NLZ40E }

Pos. 5: ~~CE5~~

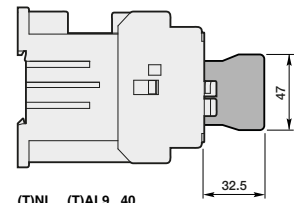

(T)NL..., (T)AL9...40

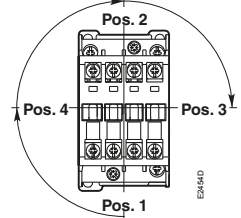

**(T)AL26**

(T)AL26-30-01  
(T)AL26-30-10  
(T)AL26-40-00  
(T)AL26-22-00\*

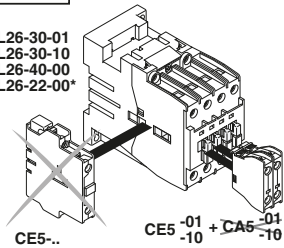

\* (T)AL26-22-00 : ~~CE5~~

Pos. 1, 2, 3, 4, 1 ± 30°, 5

(T)AL26-30-10 } max. 2 CE5-01  
(T)AL26-30-01 }  
(T)AL26-40-00 }

**(T)AL30, (T)AL40**

(T)AL30-30-01  
(T)AL30-30-10  
(T)AL40-30-01  
(T)AL40-30-10

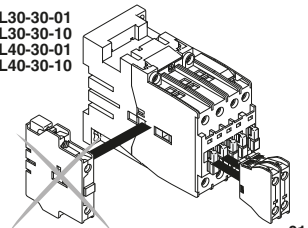

Pos. 1, 2, 3, 4, 1 ± 30°, 5

(T)AL30-30-10 } max. 2 CE5-01  
(T)AL40-30-10 }  
(T)AL30-30-01 }  
(T)AL40-30-01 }

**AL30, AL40**

AL30-30-22  
AL40-30-22

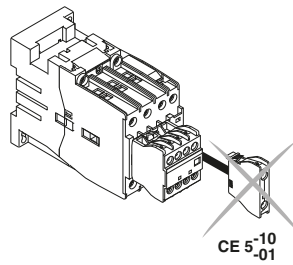

Pos. 1, 2, 3, 4, 1 ± 30°, 5

~~CE5~~

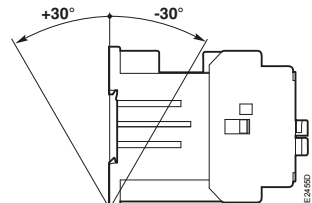

Pos. 1 ± 30°

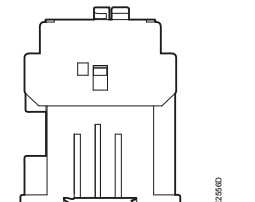

Pos. 5