

Operating Instructions Busch-AudioWorld®

Audio input 8210 U-500 Busch-AudioWorld®



1	Safety.....	3
2	Intended use	3
	2.1 Environment.....	3
3	Technical data.....	3
4	Setup and function.....	4
	4.1 Features of function and equipment.....	4
	4.2 Possible combinations	4
5	Installation and electrical connection	5
	5.1 Requirements for the electrician	5
	5.2 General installation instructions	6
	5.3 Mounting	6
	5.4 Electrical connection	7
	5.4.1 Connecting terminals	7
	5.4.2 Installation / connection possibilities	7

1 Safety



Warning

Electric voltage!

Risk of death and fire due to electrical voltage of 230 V.

- Work on the 230V supply system may only be performed by authorised electricians!
- Disconnect the mains power supply prior to installation and/or disassembly!

2 Intended use

The device is part of the Busch-AudioWorld® system and is to be used exclusively with the components that are supplied and licensed as described in the "Structure and Function" chapter. The device must only be installed in dry indoor rooms.

2.1 Environment



Consider the protection of the environment!

Used electric and electronic devices must not be disposed of with domestic waste.

- The device contains valuable raw materials which can be recycled. Therefore, dispose of the device at the appropriate collecting depot.

All packaging materials and devices bear the markings and test seals for proper disposal. Always dispose of the packaging material and electric devices and their components via the authorized collecting depots and disposal companies.

The products meet the legal requirements, in particular the laws governing electronic and electrical devices and the REACH ordinance.

(EU Directive 2002/96/EC WEEE and 2002/95/EC RoHS)

(EU REACH ordinance and law for the implementation of the ordinance (EC) No.1907/2006)

3 Technical data







Designation	Value
Operating voltage:	15 V
Max. current consumption:	40 mA
Socket:	2 x cinch (RCA) stereo
Protective class:	IP 20

4 Setup and function

4.1 Features of function and equipment

The flush-mounted audio input is used to feed an external audio source, e.g. a DVD/MP3 player, into the audio bus.

4.2 Possible combinations

	 <p>8210 U-500</p>
 <p>8202</p>	X
 <p>8208</p>	X
 <p>8209-101</p>	X
 <p>8251-2x</p>	X
 <p>8251-21x</p>	X
 <p>8251-8x</p>	X

5 Installation and electrical connection



Warning

Electric voltage!

Risk of death due to electrical voltage of 230 V during short-circuit in the low-voltage line.

- Low-voltage and 230 V lines must not be installed together in a flush-mounted socket!

5.1 Requirements for the electrician



Warning

Electric voltage!

Install the device only if you have the necessary electrical engineering knowledge and experience.

- Incorrect installation endangers your life and that of the user of the electrical system.
- Incorrect installation can cause serious damage to property, e.g. due to fire.

The minimum necessary expert knowledge and requirements for the installation are as follows:

- Apply the "five safety rules" (DIN VDE 0105, EN 50110):
 1. Disconnect from power;
 2. Secure against being re-connected;
 3. Ensure there is no voltage;
 4. Connect to earth and short-circuit;
 5. Cover or barricade adjacent live parts.
- Use suitable personal protective clothing.
- Use only suitable tools and measuring devices.
- Check the supply network type (TN system, IT system, TT system) to secure the following power supply conditions (classic connection to ground, protective earthing, necessary additional measures, etc.).

5.2 General installation instructions

- Terminate all branches of the wiring system via a connected bus device (e.g., indoor station, outdoor station, system device).
- Do not install the system controller directly next to the bell transformer and other power supplies (to avoid interference).
- Do not install the wires of the system bus together with 230 V wires.
- Do not use common cables for the connecting wires of the door openers and wires of the system bus.
- Avoid bridges between different cable types.
- Use only two wires for the system bus in a four-core or multi-core cable.
- When looping, never install the incoming and outgoing bus inside the same cable.
- Never install the internal and external bus inside the same cable.

5.3 Mounting

The flush-mounted insert must only be installed in flush-mounted wall boxes according to DIN 49073-1, Part 1, or suitable surface-mounted housings.

Installation only in a 60 flush-type box in accordance with DIN 4973-1 (Fig. 1 socket 2x cinch (RCA) stereo).

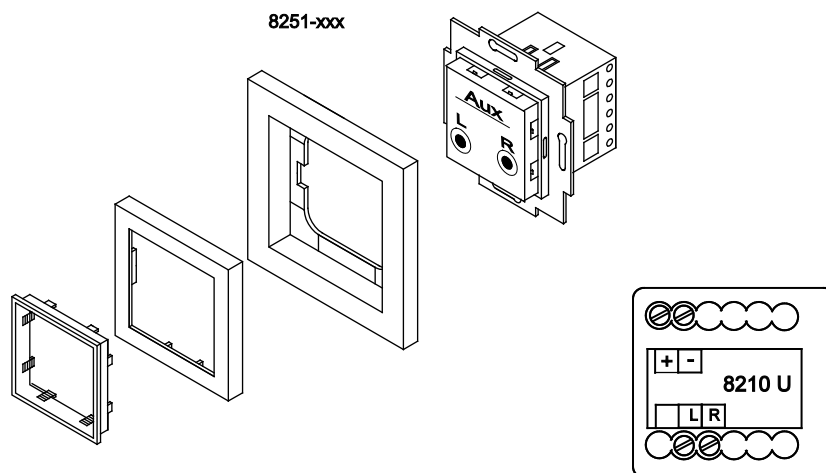

Fig. 1:

5.4 Electrical connection

5.4.1 Connecting terminals

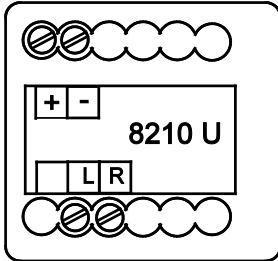

Fig. 2: Connection

No.	Assignment
+	Louder
-	Lower
L	Left channel
R	Right channel

5.4.2 Installation / connection possibilities

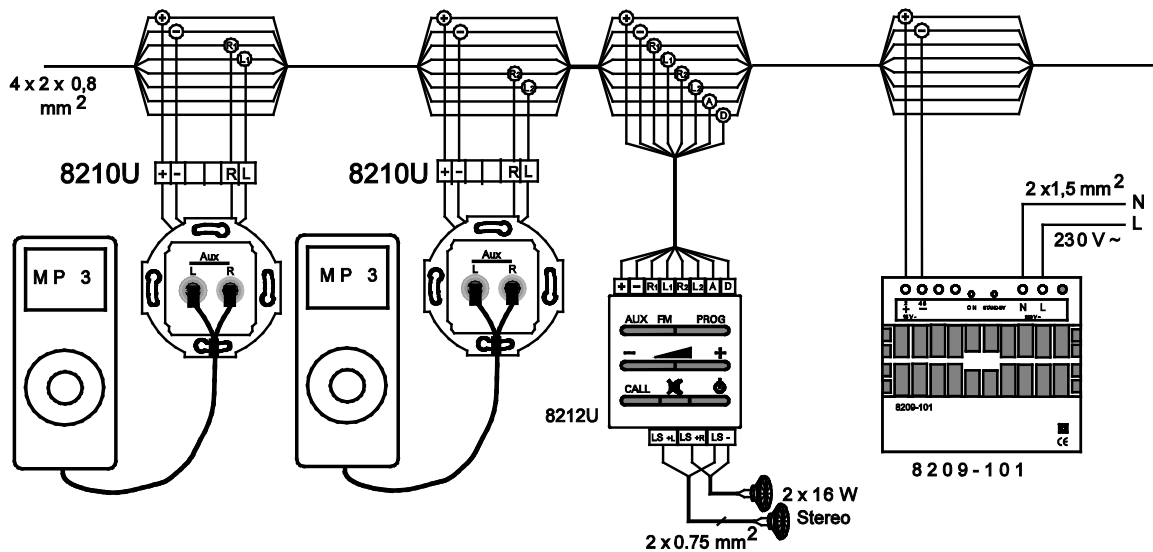

Fig. 3: Connection



Note

If 2 audio inputs 8210 U are used, the channels are switched with the AUX/FM button at the amplifier insert 8211/8212 U.-

In case of connection to a central unit, disconnect the R+ and R- clamps on the RJ45 socket.

A member of the ABB Group

Busch-Jaeger Elektro GmbH

PO box
58505 Lüdenscheid

Freisenbergstraße 2
58513 Lüdenscheid
Germany

www.BUSCH-JAEGER.com

info.bje@de.abb.com

Central sales service:

Phone: +49 (0) 2351 956-1600

Fax: +49 (0) 2351 956-1700

Notice

We reserve the right to at all times make technical changes as well as changes to the contents of this document without prior notice.

The detailed specifications agreed to at the time of ordering apply to all orders. ABB accepts no responsibility for possible errors or incompleteness in this document.

We reserve all rights to this document and the topics and illustrations contained therein. The document and its contents, or extracts thereof, must not be reproduced, transmitted or reused by third parties without prior written consent by ABB.

Copyright© 2012 Busch-Jaeger Elektro GmbH
All rights reserved