

Product catalogue

UniGear ZS3.2 metal-enclosed switchgear

Fitted with withdrawable VD4 breaker and SF₆ breaker 40.5 kV ...3150 A ...31.5 kA



- Safety
- Reliability
- Flexibility
- Economy

Table of contents

005	1	Summary
006	2	Technical data
007 – 011	3	Switchgear panel structure
012 – 017	4	Main apparatus on the main circuit
018	5	Main components in the auxiliary circuit
019 – 022	6	Main wiring diagram
023 – 025	7	Assembly of the switchgear at site
026	8	Ordering instruction

UniGear ZS3.2 metal-enclosed switchgear

Fitted with VD4/ HD4 40.5 kV ...3150 A ...31.5 kA

UniGear ZS3.2 - with advanced technical position of switchgear device

UniGear ZS3.2 - safety and reliability

- Metal-enclosed switchgear device
- Uniform electrical field design, main circuit coppers are covered with Raychem heat shrinkable tube that has good insulating capacity and heat dissipation
- LV compartment and between other compartments are separated with earthed metal steel
- With high speed making capacity earthing switch can making short-time circuit current
- All operations are done in front of the device with the cubicle doors closed, which contains making and breaking circuit-breaker, rocking in/out the trolley and operating earthing switch
- Reliable and safety interlock can avoid mal-operation
- There are check windows on the front and back doors. Whether the circuit-breaker is closed or opened, the earthing switch position, stored energy condition, and the cable terminal status can all be seen through the windows

UniGear ZS3.2 - availability and flexibility

- Vacuum breaker or SF₆ breaker technology is

available

- Circuit-breakers with the same ratings are interchangeable between switchgears
- Various panels can satisfy most customers' requirement

UniGear ZS3.2 - suitable for all applications

- Complies with IEC and also with the Chinese "GB/T" national standards, and GOST specification
- Technical data, including high dielectric withstand capacity, allows application in most systems where electrical energy is generated, distributed or utilized
- There are maximum three power cable connection positions

1 Summary

1.1 General

UniGear ZS3.2 produced by Xiamen ABB switchgear Co., Ltd. (below is UniGear ZS3.2 for short) is developed by ABB Group. It is an advanced medium voltage switchgear. It is suitable for the three-phase AC 50/60 Hz power system and it is used for power transmission and distribution, and power energy control protection and monitoring.

UniGear ZS3.2 is equipped with withdrawable VD4 and HD4. It's an advanced robust safe and reliable power distribution device.

1.2 Standards and specifications

UniGear ZS3.2 complies with the following specifications

IEC standards:

IEC 62271-200: 2011 High-voltage switchgear and controlgear – Part 200: AC metal-enclosed switchgear and controlgear for rated voltages above 1 kV and up to and including 52 kV.

IEC 62271-100: 2012 High-voltage switchgear and controlgear– Part 100: Alternating-current circuit-breakers

Chinese standards:

GB/T 3906 Alternating-current metal-enclosed switchgear and control-gear for rated voltage above 3.6 kV and up to and including 40.5 kV

GB/T 11022-2011 Common specifications for the high-voltage switchgear and controlgear

1.3 Service conditions



1.3.1 Normal service conditions

The switchgears are fundamentally designed for the normal service conditions for indoor switchgears IEC publication 62271-1. The following limit values, among others, apply:

Ambient temperature:

Maximum	+40 °C
Maximum 24 h average	+35 °C
Minimum (According to “minus 15 indoor class”)	-15 °C

Humidity

Highest average value measured Over 24 hours relative humidity	95 %
Highest average value measured Over 1 month relative humidity	90 %

The maximum site altitude	1000 m
---------------------------	--------

Seismic intensity no more than	8 degree
--------------------------------	----------

Remark:

If the switchgear is installed indoors, it is assumed that the humidity within the enclosure can reach high values, but that there is normally no condensation on the installed equipment. Condensation can be prevented by appropriate configuration of the station building or switchgear room.

1.3.2 Special service conditions

According to IEC 62271-100, the manufacturer and user may agree on special service conditions which deviate from the normal service conditions. The manufacturer must be consulted in advance about all special service conditions.

Examples are as follows:

- At site altitudes above 1000 m, the effects of the reduction in dielectric strength of the air on the insulation level are to be taken into account
- Increased ambient temperatures must be compensated for in the design of the busbars and tee-off conductors, or the current carrying capacity will be limited. Heat dissipation in the switchgear panel can be assisted by fitting additional ventilation facilities

2 Technical data

2.1 UniGear ZS3.2 main parameters (table 1)

Table 1: UniGear ZS3.2 technical data

Item	Unit	Data
Rated voltage	kV	36 (IEC) 40.5 (Chinese GB/T)
Rated power frequency withstand voltage/1 min	kV	70 95
Rated lightning impulse withstand voltage	kV	170 185
Rated frequency	Hz	50
Rated current of busbars	A	1250, 1600, 2000, 2500, 3150
Rated current of tee-offs, circuit-breaker	A	1250, 1600, 2000, 2500, 3150*
Rated peak withstand current	kA	...63, 80
Rated short-circuit breaking current	kA	...25, 31.5
Rated short-time withstand current 4 s	kA	...31.5
Loss of service continuity category		LSC 2B
Internal ARC		IAC AFLR
IP	IP	IP4X/ IP2X (between compartments)
Auxiliary voltage**	V	DC110, 220 AC110, 220

* Forced ventilation

** It can be other voltage according customer's requirement.

2.2 UniGear ZS3.2 delivery test

UniGear ZS3.2 has passed all the necessary tests according to IEC and Chinese GB/T. Guarantee each product meets the standards.

3 Switchgear panel structure

3.1 General

UniGear ZS3.2 consists of cubicles and withdrawable trucks (trolleys). According to the function of electrical equipment cabinet, UniGear ZS3.2 contains four different compartments (figure 3.1): Busbar Compartment C, Circuit-breaker Compartment A, Power Cable Compartment D, Low Voltage Compartment B. The whole panel is constructed by bolting up the double folded components made of high quality earthed Al-Zn sheet steel, precisely folded and exactly fitted surface from and extremely rigid construction. The illustration shows the structure of a panel and the electrical equipment fitted.

The withdrawable part in the cabinet can be a vacuum breaker, a SF6 breaker, a voltage transmission truck, a fuse truck or an isolator truck.

The circuit detecting device in the cabinet can indicate the main circuit's working status. It contains a sensor fitted at the cable site in the cabinet and an indicator fitted on the door of the low voltage compartment.

IP 4X is for the enclosure and IP 2X is for the partitions.

The switchgear units have been tested in according with Criteria 1 to 5, Class A, Annex A, IEC 62271-200, the switchgear units are classified as IAC AFLR 31.5 kA for 1 s.

Panel dimension and weight are shown below

Height	mm	2400
Width	mm	1200
Depth	mm	2565
Weight	kg	1200-3000

3.2 Enclosure, partitions and pressure relief

The enclosure and internal partitions of the switchgear panel are made of high quality Aluminum Zink coated steel sheet. The three high-voltage compartments are fitted with secured pressure relief plates located at the top. These open upward if internal arc faults occurs. The front and rear of the panel are closed off by flameproof doors which open to an angle of almost 180°. Neighboring switchgear panels are partitioned from one another by the side walls of each panel and the air cushion which remains between these walls as a result of the design when the panels are joined together. This method of construction prevents them from melting if an arc fault occurs.

All the heads of the structure bolts do not stick up the fitting surface on the side walls as a result of embossing processing used. Thanks to that, it is possible to remove the middle panel of the switchgear without removing the adjacent panels. The separately fitted low-voltage compartment B is designed as a self-supporting shockproof and flameproof sheet steel enclosure, separated from the high-voltage area. Even with the withdrawable part 50 removed (hinged shutters 35.1/ 35.2 in the closed position), there is protection against contact with live parts in busbar compartment C and cable connection compartment D.

The necessary safety measures to counteract the effects of an internal arc fault must be ensured in connection with the ceiling height. This may in individual cases possibly necessitate additional operator protection measures on the switchgear panels.

The front and rear doors of the switchgear panel and the cover plates of the end panel are thoroughly cleaned, treated to prevent corrosion, and then painted with a high quality coat stove enamel system in color RAL7035 (or special color as agreed) which are notable after stoving for their particular insensitivity to impact and corrosion.

3.1 UniGear ZS3.2 section view, basic structure of an incoming or outgoing feeder panel...1600 A

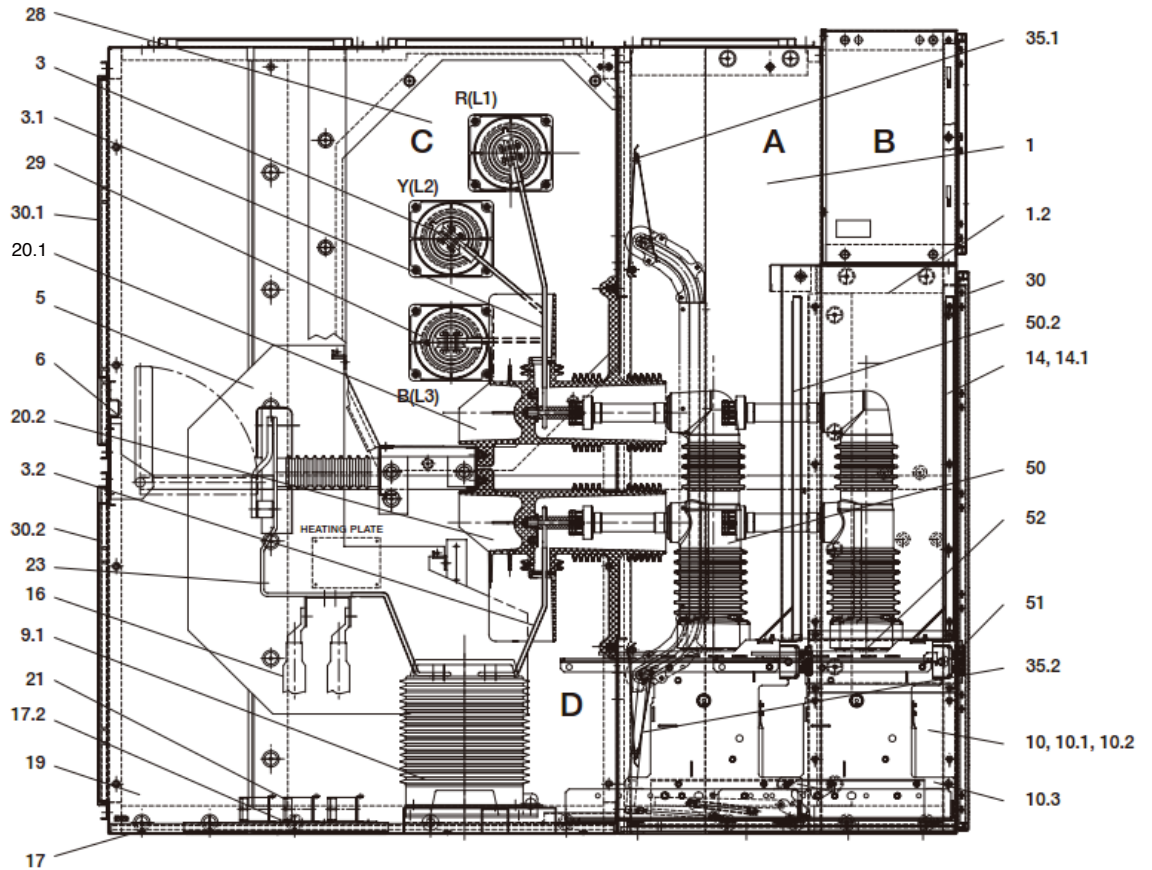

- | | | | |
|------|-------------------------------------|------|---|
| A | Circuit-breaker compartment | 17 | Floor cover plate |
| B | Low-voltage compartment | 17.2 | Reducer ring |
| C | Busbar compartment | 19 | Main earthing bar |
| D | Cable compartment | 20.1 | Spout, above |
| 1 | Enclosure | 20.2 | Spout, below |
| 1.1 | Pressure relief plate | 21 | Cable clamp |
| 1.2 | Control wiring duct | 23 | Cable connection point |
| 3 | Busbar | 25.1 | Contact pin |
| 3.1 | Tee-off conductor, busbar side | 28 | Bushing plate |
| 3.2 | Tee-off conductor, cable side | 29 | Busbar bushing |
| 5 | Insulated separating plate | 30 | Front door for circuit-breaker compartment |
| 6 | Earthing switch | 30.1 | Rear panel cover, above |
| 9.1 | Current transformer | 30.2 | Rear panel cover, below |
| 10 | Control wiring plug connector | 35.1 | Hinged shutter system, above |
| 10.1 | Control wiring socket | 35.2 | Hinged shutter system, below |
| 10.2 | Control wiring plug | 50 | Withdrawable part (with circuit-breaker, type VD4 or HD4) |
| 10.3 | Interlocking arm for wiring plug | 50.2 | Front partition plate |
| 14 | Earthing Switch operation mechanism | 51 | Interlock yoke |
| 14.1 | Hexagonal shaft | 52 | Spindle |
| 16 | Cable sealing ends | | |

-
- 3.2 Circuit-breaker compartment (shutter opened)
-
- 3.3 Circuit-breaker compartment (shutter closed)
-
- 3.4.1 VD4 vacuum circuit-breaker
-
- 3.4.2 VD4 operating mechanism

3.3 Circuit-breaker compartment

The circuit-breaker compartment A fitted with the necessary guide rails accommodates the withdrawable part 50, which can be moved between the service position and the test/disconnected position.

If the withdrawable part is moved from the service position into the test/disconnected position, the fixed contact 25.1 located in the connection block 20.1/20.2 in busbar compartment C and cable connection compartment D are automatically covered by metal plates which will be locked mechanically or can be locked by a padlock when the withdrawable part is moved away. In the test/disconnected position, the withdrawable part is still completely inside the panel with the door closed.

The switching operations (including manual operation) are carried out with the doors closed.

3.4 Trolley

The truck frame welded with cold-rolled steel. As different function, the truck can be a circuit-breaker truck, a voltage transformer truck, a fuse truck, or an isolation truck. And each truck has the same depth and height. Trucks can be exchanged when their ratings are the same.

Positions of the truck in the panel are working positions, test/service positions, and there is a reliable interlock at each position. Interlocks can avoid mal-operation efficiently.

The truck can be rolled in/out only when the circuit-breaker is at an opened condition.

Users can know the position and opened/closed status of the circuit-breaker through the check window on the circuit-breaker compartment and indicator fitted on the low voltage compartment door.

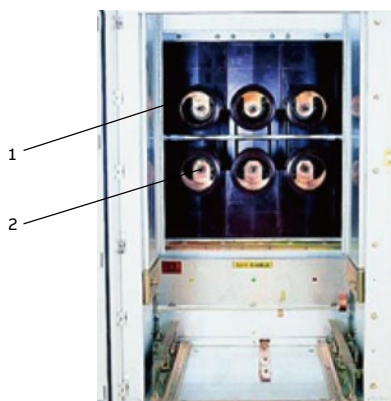

1 Spout
2 Contact pin

—
3.2

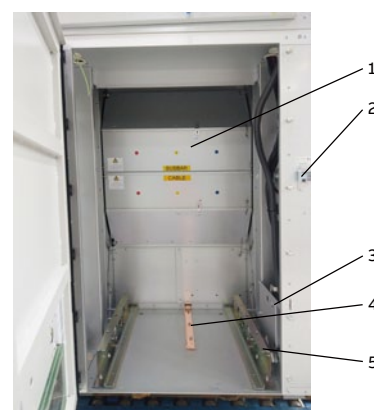

1 Shutter system
2 Operation hole for EK6
3 Truck position lock holes
4 Earthing rail
5 Guide rail

—
3.3

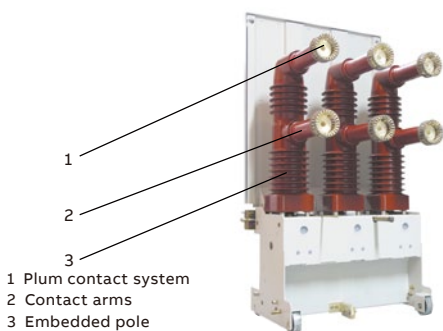

1 Plum contact system
2 Contact arms
3 Embedded pole

—
3.4.1

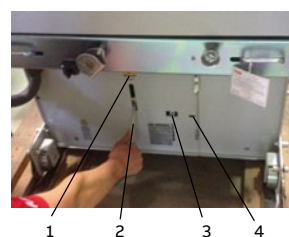

1 Charging condition indicator
2 Charging pole
3 Switch position indicator
4 Operating cycle counter

—
3.4.2

3.5 Contact system

The spring-loaded contact systems with a plum type structure is fitted on the contact arms (Figure 3.4.1). Contact systems connect with contact pins, its advantage is low contact resistance, able to tolerate higher electric power and more uniform electrical field.

3.6 Busbar compartment (Figure 3.1)

Busbars 3 are laid in sections from panel to panel, and are held in place by the tee-off conductor 3.1 and by the busbar bushing 29. The conductor material used is tubing with a D-shaped cross-section, in either single or double configuration depending on the current rating, or rectangle copper bar (rated current ≤ 1600 A). The connection to the flat tee-off conductors is made without any special connecting clamps.

3.7 Power cable compartment (Figure 3.1)

Current transformers and an earthing switch are located here. Surge arrestors can be installed. Multiple parallel power cables can also be entered conveniently. The cable sealing ends 16 can be fitted in particularly favorable conditions. A removable plate for cable glands is located in the cable entry area.

Installation of voltage transformers truck at cable side version will have influence on the depth of the panel.

The earthing switch is designed with a making capacity of 80 kA.

The detailed information on the earthing switch can be found in the corresponding instruction manual.

3.8 Low voltage compartment

The low-voltage compartment, together with its front door, accommodates the secondary equipment of the switchgear panel required for the particular application.

The control wiring in the switchgear panel area is led through generously dimensioned and metal covered ducts. The left hand duct is reserved for the incoming and outgoing control wires, and the internal wiring in the panel is located on the right hand side.

At the top of the left hand duct, an entry for control cables is reserved with the free-cut rubber sealing which will keep the protection class IP4X for the whole enclosure of the switchgear panel.

3.9 Interlock against mal-operation (Figure 3.1)

A series of interlocks are provided to prevent fundamentally hazardous situations and mal-operation, thus protecting both personnel and the switchgear itself. The interlocks which are normally individually effective are as follows:

- The withdrawable part can only be moved from the test/disconnected position into the service position (and back) with the circuit-breaker opened and the earthing switch opened (between positions, the circuit-breaker is mechanically interlocked, and also electrically interlocked in the case of circuit-breaker with electrical releases)
- The circuit-breaker can only be closed when the withdrawable part is precisely in the defined test position or service position. Between these positions, the circuit-breaker is mechanically interlocked, and also electrically interlocked in the case of circuit-breaker with electrical releases
- The circuit-breaker can only be opened manually in the service or test position when no control voltage is applied, and cannot be closed (electro-mechanical interlock)
- Low-voltage plug 10.2 can only be inserted or removed when the withdrawable part is in the test/disconnected position
- Earthing switch 6 can only be closed when the withdrawable part is in the test/disconnected position or the removed position (mechanical interlock)
- The withdrawable part cannot be moved from the test/disconnected position into the service position when the earthing switch is closed (mechanical interlock)
- Details of any additional interlocks, e.g. in connection with a blocking magnet on the withdrawable part and/or earthing switch operating mechanism, can be found in the order documents for each individual case
- The hinged shutters can be secured with padlocks in the closed position after the withdrawable part has been removed

- 3.5 Power cable compartment
- 3.6 Low voltage compartment
- 3.7 Busbar compartment

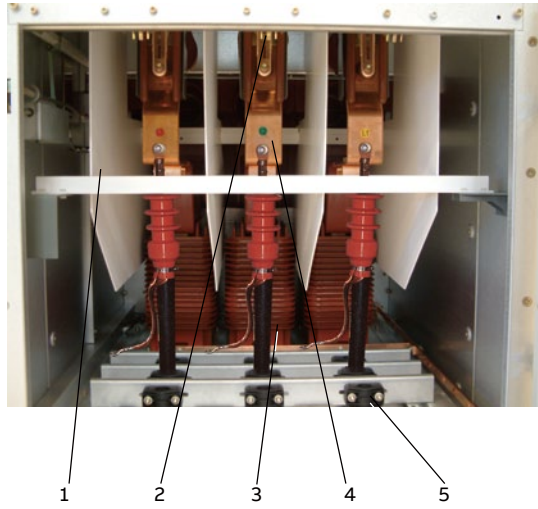

3.5

- 1 Insulating separate plates
- 2 Fixed earthing contact
- 3 Current transformer
- 4 Cable connect bar
- 5 Cable clamp

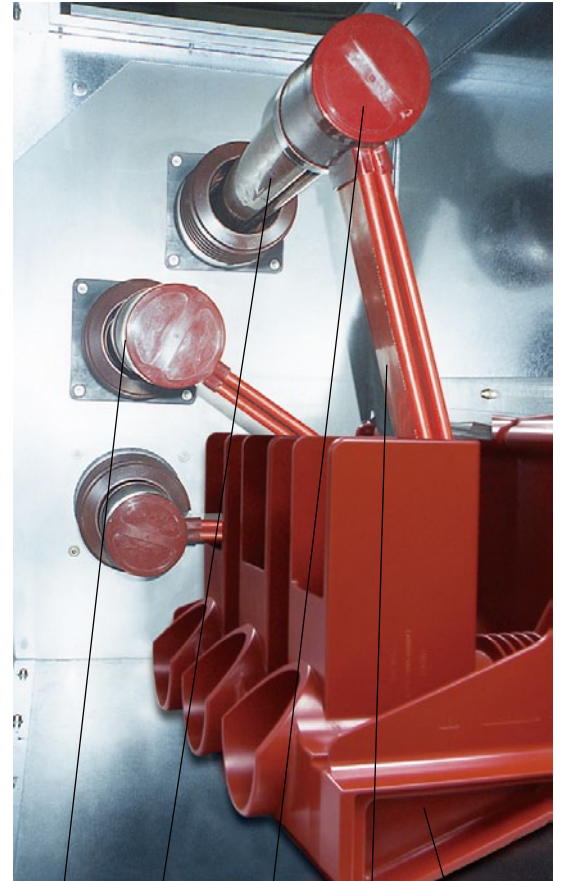

3.7

- 1 Busbar bushing
- 2 Main busbar (D type or rectangle bar)
- 3 Insulation cover
- 4 Tee off conductor, busbar side
- 5 Spout

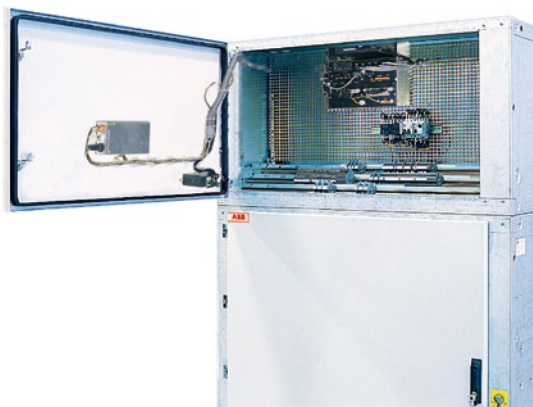

4 Main apparatus on the main circuit

—
4.1 VD4 operation
side view

—
4.2 VD4 contact arm
side view

—
4.3 Contact operation
side view

—
4.4 Contact arm
side view

All apparatus in the main circuit are developed by ABB group, or provided by ABB qualified suppliers. This ensures that each UniGear ZS3.2 has the same quality, stable performance, safety and reliability.

Below is the simple instruction of the main apparatus in the main circuit. As for detail message and parameters of these apparatus, please see related product specifications (VD4: 1YHA000093, HD4: 1YHA000046).

4.1 Circuit-breaker

The VD4 vacuum circuit-breaker is one of the main apparatus in the main circuit (Figure 4.1, Figure 4.2). It is produced by ABB, and applies to IEC standards and Chinese GB/T.

Vacuum circuit-breakers have particular advantages for use in networks where there is a high switching frequency in the working current range and/or where a certain number of short-circuit breaking

operations are expected. Type VD4 vacuum circuit-breakers are suitable for auto-reclosing, and have exceptionally high operating reliability and long life.

The operating mechanism is fundamentally suitable for auto-reclosing and, due to the short charging times, also for multi-shot auto-reclosing.

Technical parameters of VD4 as below Table 2 and Figure 4.5

UniGear ZS3.2 is also fitted with another main apparatus HD4 (Figure 4.3, Figure 4.4).

HD4 medium voltage circuit-breakers use Sulphur hexafluoride gas (SF₆) to extinguish the electric arc and as the insulating medium.



—
4.1



—
4.2



—
4.3

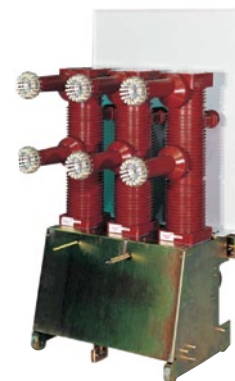

—
4.4

SF₆ has smooth breaking characteristics, therefore breaking in SF₆ gas takes place without any arc chopping and without generation of over voltages.

These characteristics ensure long electrical life of the circuit-breaker and limited dynamic, dielectric and thermal stresses on the installation.

The circuit-breaker poles, which make up the breaking part, are systems with lifelong sealed pressure (IEC 62271-100 and GB/T 1984-2003 Standards) and are maintenance-free.

The ESH type mechanical operating mechanism of HD4, with stored energy has free release and allows opening and closing operations independently of the operator's actions.

The operating mechanism and the poles are fixed to the metal structure which also acts as a support for the kinetics for operating the moving contacts.

Technical parameters of HD4 as shown in the following Table 3 and Figure 4.6

Table 2 Technical parameters of the VD4 vacuum circuit-breaker

Item	Unit	IEC					GB/T
Rated voltage	kV	36					40.5
Rated power frequency withstand voltage/1 min	kV	70					95
Rated lightning impulse withstand voltage	kV	170					185
Rated frequency	Hz	50					
Rated current	A	1250	1600	2000	2500	3150*	
Rated peak withstand current	kA	...63, 80					
Rated short-circuit breaking current	kA	...25, 31.5					
Rated short-time withstand current 4 s	kA	...31.5					
Rated operating sequence		O-3 min-CO-3 min-CO					
Rated operating sequence with auto-reclosing		O-0.3 s-CO-3 min-CO					
Closing time	ms	55-67					
Opening time	ms	33-45					
Arcing time (at 50 Hz)	ms	≤15					
Net weight	Kg	290	290	340	340	390	

Table 3 Technical parameters of the HD4 SF6 circuit-breaker

Item	Unit	IEC					GB/T
Rated voltage	kV	36					40.5
Rated power frequency withstand voltage/1 min	kV	70					95
Rated lightning impulse withstand voltage	kV	170					185
Rated frequency	Hz	50					
Rated current	A	1250,	1600,	2000,	2500,	3150*	
Rated peak withstand current	kA	...63, 80					
Rated short-circuit breaking current	kA	...25, 31.5					
Rated short-time withstand current 4 s	kA	...31.5					
Rated operating sequence		O-3 min-CO-3 min-CO					
Rated operating sequence with auto-reclosing		O-0.3 s-CO-3 min-CO					
Closing time	ms	55-67					
Opening time	ms	33-45					
Arcing time (at 50 Hz)	ms	≤15					
Gas absolute pressure (20 °C)**	kPa	550					
Net weight	Kg	370	370	390	390	410	

* Forced ventilation

** Rated value

Table 3 VD4 operation mechanism parameter

	Auxiliary (V)	Motor consumption Power (VA/W)	Charging time (s) (Max)	Closing trip power (VA/W)	Opening trip power (VA/W)	Locking electromagnet Power (VA/W)
AC	110	150	15	250	250	10
	220	150	15	250	250	10
	240	170	15	310	310	10
DC	24	130	15	250	250	10
	48	130	15	250	250	10
	60	130	15	250	250	10
	110	140	15	250	250	10
	220	140	15	250	250	10

Table 4 HD4 ESH operation mechanism parameter

Opening trip	Ps	125 W/VA
	t	~50 ms
	Un	24, 30, 48, 60, 110, 125, 220 V-
	Un	48, 110, 127, 220, 230, 240 V~50 Hz
Closing trip	Un	110, 127, 220, 230, 240 V~60 Hz
	Ps	250 W/VA
	t	150 ms
	Pc	5 W/VA (trip prevention function)
	t	80 ms
	Un	24, 30, 48, 60, 110, 125, 220 V-
	Un	48, 110, 127, 220, 230, 240 V~50 Hz
Under voltage release	Un	110, 127, 220, 230, 240 V~60 Hz
	Ps	250 W/VA
	t	150 ms
	Pc	5 W/VA
	t	80 ms
	Un	24, 30, 48, 60, 110, 125, 220 V-
Charging motor	Un	48, 110, 127, 220, 230, 240 V~60 Hz
	Un	110, 127, 220, 230, 240 V~60 Hz
	Ps	1500 W/VA
	t	100 ms
	Pc	400 W/VA
	t	5~7 s
	Un	24, 30, 48, 60, 110, 125, 220 V-
Locking electromagnet	Un	48, 110, 127, 220, 230, 240 V~50 Hz
	Un	110, 127, 220, 230, 240 V~60 Hz
	Ps	250 W/VA
	t	150 ms
	Pc	5 W/VA
	t	80 ms
	Un	24, 30, 48, 60, 110, 125, 220 V-

—
 4.5 Permissible number of VD4 vacuum interrupter switching operations in relation to breaking current
 —
 4.6 Permissible number of SF₆ interrupter switching operations in relation to breaking current

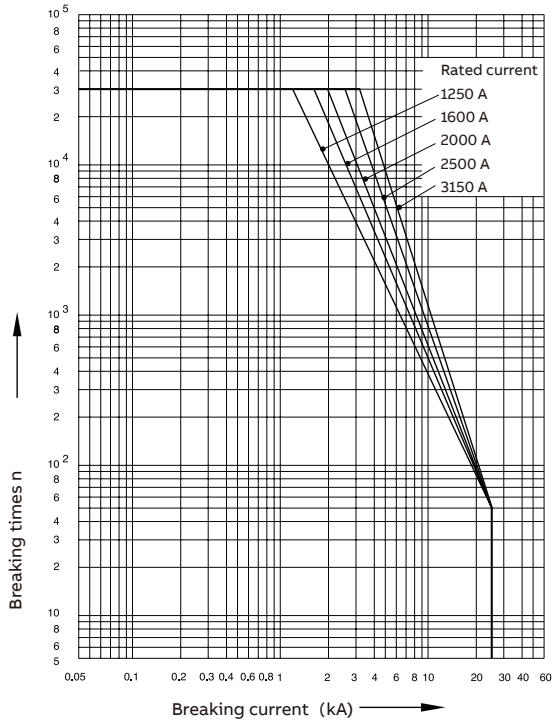

a) 40.5 kV, 1250...3150 A, 25 kA

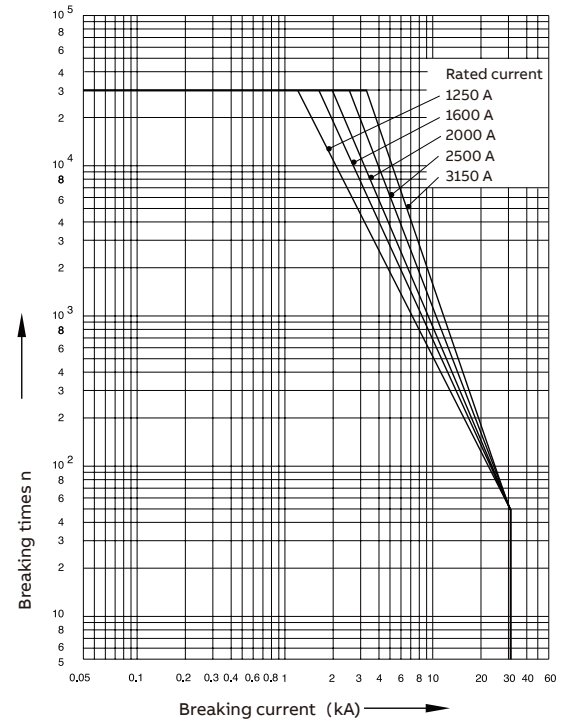

b) 40.5 kV, 1250...3150 A, 31.5 kA

—
 4.5

number of operations permitted at rated breaking current

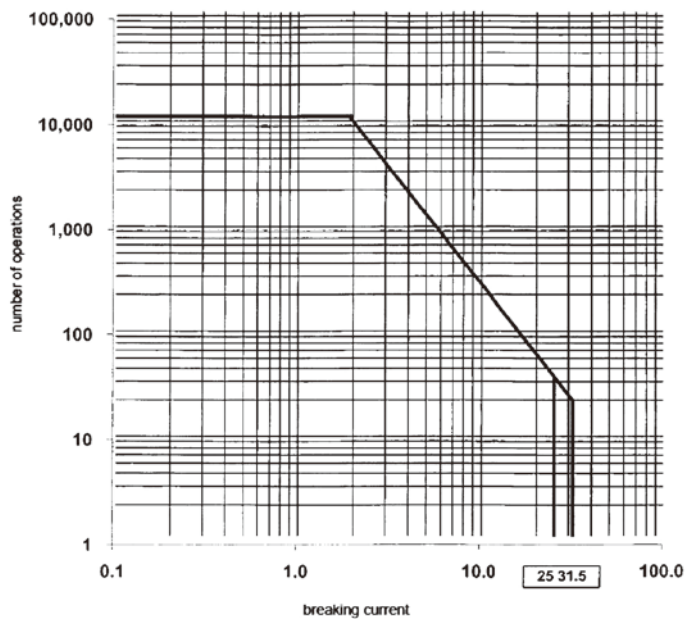

—
 4.6

- 4.7 MWD/MWK surge arrester
- 4.8 Earthing switch

4.2 Surge arrester

The MWK/MWD is a surge arrester intended for use in high and medium voltage applications. Surge arresters protect the insulation of high voltage and medium voltage devices against over voltages which are caused by lightning or switching operations.

The MWK/MWD surge arrester is made of serially connected, non-linear metal-oxide (MO) resistors. These MO resistors have an extremely non-linear resistance property. At the maximum operating voltage of U_c , only a small capacitive current will flow in the mA range. With an increase in voltage, the MO resistors enter a highly-conductive state practically without delay. Thus any further increase in voltage is limited to the specified residual voltage values. After the decline of the over voltage the arrester immediately turns back to the non- or slightly-conductive state. The MO arrester converts the energy of the surge into heat, which it transfers to the surrounding air.

The stack of MO resistors and connection equipment is held together with strong strips made of fiberglass-reinforced plastic. The directly molded silicone housing with sheds protects it from all environmental and weather influences. This design has proven to be the best solution in every envi-ronment for years. For indoor applications without pollution sheds are not required.

Thanks to its high energy absorbing capability and low protective level, the MWK, MWD is especially suited for overvoltage protection of:

- Transformers
- Cables, motors
- Other high- and medium-voltage apparatuses and systems

4.3 Earthing Switch (Figure 4.8)

Earthing switches of series EK6 are determined for indoor installation and confirmed to the requirements of IEC publications of 62271-102:2001 and Chinese GB/T 1985. They are fitted with snap-action operating mechanisms for positive high-speed closing and sufficiently dimensioned to conduct rated short-current making current when closed under load. The speed of the snap-action closing operation is independently controlled.

The earthing switches are supplied as kits with a pre-assembled active part and corresponding earthing contacts supplied loose. Correct installation of these parts in a switchgear panel results in a functioning earthing switch.

Routine tests to IEC 62271-102:2001 and Chinese GB/T 1985 are to be carried out at the site accordingly.

Table 5 Technical parameters of the surge arrester

Type	Rated voltage (kV)	Continuous working voltage U_c (kV)	Residual voltage at different waves and discharging currents (kV)										
			1/3 μ s			8/20 μ s				30/60 μ s			
MWD /MWK			1 kV	5 kA	10 kA	1 kV	5 kA	10 kA	20 kA	100 A	250 A	500 kA	1000 kA
41	51.3	41	107.4	131.6	148.6	106.6	118.9	125.9	139.4	92.7	97.6	100.9	105.0
44	55.0	44	115.3	141.3	159.4	114.4	127.6	135.1	149.6	99.4	104.7	108.2	112.7



MWD

— 4.7



MWK

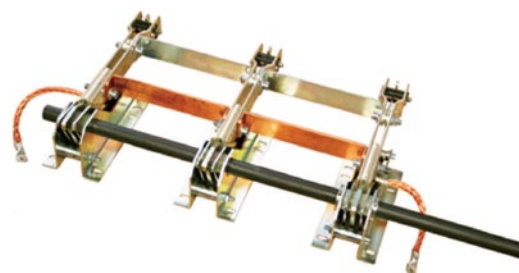

— 4.8

—
4.9 Current transformer
—
4.10 Voltage transformer

4.4 Transformer

UniGear ZS3.2 is fitted with current transformer and voltage current supplied by ABB qualified suppliers.

Ensure it has the same life with the switchgear. Its main parameters are shown in Table 7 and Table 8.

Attention: The short-time withstand current and the peak withstand current of the current transformer should be recertified according to the transformation ratio.

—
Table 6 EK6 parameters

Item	Unit	Parameters
Rated voltage	kV	40.5
Distance of ph-to-ph.	mm	280
Rated short-time withstand current	kA/s	31.5/4
Making current (peak)	kA	80
Operating voltage of electromagnet	V	DC48, 110, 220; AC110, 220



—
4.9

—
Table 7 Technical parameters of the current transformer

Item	Unit	Data
Rated voltage	kV	40.5
Rated frequency withstand voltage	kV	95
Rated lightning impulse withstand voltage (peak value)	kV	185
Rated primary current	A	50...3150
Rated secondary current	A	1, 5
Accuracy class		0.2, 0.5, 1.0, 3.0, 5P10, 5P20, 10P10, 10P20
Rated capacity	VA	10...30
Rated short-time withstand current (4 s)	kA	25, 31.5
Rated peak withstand current	kA	63, 80

—
Table 8 Technical parameters of the voltage transformer

Item	Unit	Data
Rated primary voltage	kV	35/ $\sqrt{3}$ 35
Rated frequency withstand voltage	kV	95
Rated lightning impulse withstand voltage (peak value)	kV	185
Rated secondary voltage	V	100/ $\sqrt{3}$ 100
Accuracy class		0.2, 0.5, 1.0, 3.0
Rated capacity	VA	20-100



—
4.10

5 Main apparatus in the secondary circuit

5.1 Protect Relay

In principle, UniGear ZS 3.2 is fitted with ABB group's advanced Relion series comprehensive protective relay, and also fitted with other relay according to the customer's requirements.

ABB Relion® protection and control

A comprehensive intelligent end solution used in the process from the Intercontinental power transmission to the power distribution.

ABB Relion® products provide protection, control, measure and monitoring for the power system. To comply with the development of the power system, Relions have been developed based on the IEC 61850 application. ABB has advanced technique and good reference all over the world.

Managing device PCM based on IEC 61850 protection and control equipment provide a complete function at full life cycle for all Relion Protection and Control Equipment on every voltage level. Relion really satisfies all communication function and efficiency that IEC 61850 requires.

Application	Type	670	650	630
Feeder protection	REF			■
Spacer layer control	REC	■	■	
Transmission protection	RET	■	■	■
Circuit distance protection	REL	■	■	
Differential protection	RED	■		
Motor protection	REM			■
Generator protection	REG	■	■	
Busbar protection	REB	■	■	
Voltage protection	REU			

Application	Type	615	610	605
Feeder protection	REF	■*	■*	■
Spacer layer control	REC			
Transmission protection	RET	■*		
Circuit distance protection	REL			
Differential protection	RED	■		
Motor protection	REM		■	
Generator protection	REG			
Busbar protection	REB	■*		
Voltage protection	REU	■*	■	

5.2 Measuring instrument

Measuring instruments are arranged, mainly according to the requirements of the user, and meet the requirements of GB/T measuring instrument guide. UniGear ZS3.2 is equipped with imported instruments, including the electric energy meter, counting meter and transmitter. It can also be based on the user's requirements with the specified domestic instrument.

5.3 Auxiliary switch

UniGear ZS3.2 is equipped with a variety of ABB auxiliary switches, which are reliable in quality.

5.4 Position indicator

The positions of the circuit breaker and the earthing switch are indicated by the LED position indicator which is combined with a simulate bus. It has the advantages of low power consumption, long life, distinct instructions and so on. It can also be used to monitor the operation of the power supply and monitor the truck is in place.

5.5 Other components

Operation power protection by ABB or the world well-known company Micro air circuit-breaker (MCB), in principle does not use low voltage fuses, to reduce wearing parts.

UniGear ZS3.2 uses an ABB brand secondary terminal.

The auxiliary switch and the secondary connector are all ABB's patented products. Simple structure, excellent performance and reliable operation.

6 Main wiring diagram

Classification code of each function in main wiring diagram

I-Incoming, F-Feeder, D-Divider, B-Bus-tie, R-Bus-riser, M-Measuring, P-Voltage measuring, T-Transformer

Solution code	01	02	03	04	05
Main wiring diagram					
Rated current	1250-3150	1250, 1600	1250, 1600	1250	1250
Main device	Breaker	VD4/HD4	VD4/HD4	VD4/HD4	VD4/HD4
	Current transformer	3	3	3	3
	Voltage transformer		3	3	
	Fuse		3		
	Earthing switch	Option		Option	
	Surge arrester	Option	Option	Option	Option
	Electrification indicator	Option	Option	Option	Option
Function	I.F	I.F	I.F	I.F	I.F
Dimension (w*D*H) mm	1200*2565*2400	1200*2565*2400	1200*2565*2400	1200*2565*2400	1200*2565*2400

Solution code	06	07	08	09	10
Main wiring diagram					
Rated current	1250	1250, 2000	1250-3150	1250	1250-3150
Main device	Breaker	VD4/HD4	VD4/HD4	VD4/HD4	VD4/HD4
	Current transformer	0-3	3	3	3
	Voltage transformer				
	Fuse				
	Earthing switch	Option			
	Surge arrester	Option	Option		Option
	Electrification indicator	Option	Option	Option	Option
Function	I.F	B	B	I.B	I
Dimension (w*D*H) mm	1200*2565*2400	1200*2565*2400	1200*2565*2400	1200*2565*2400	1200*2565*2400

Classification code of each function in main wiring diagram

I-Incoming, F-Feeder, D-Divider, B-Bus-tie, R-Bus-riser, M-Measuring, P-Voltage measuring, T-Transformer



Solution code	11	12	13	14	15
Main wiring diagram					
Rated current	1250	1250	1250-3150	1250, 2000	
Breaker	VD4/HD4				
Current transformer	3	3	3		
Voltage transformer		3	3		3
Fuse		3	3		3
Earthing switch	Option	Option	Option		
Surge arrester	Option	Option	Option		
Electrification indicator	Option	Option	Option	Option	
Function	I,F	I,F	I,F	I,F	P
Dimension (w*D*H) mm	1200*2565*2400	1200*2565*2400	1200*2565*2400	1200*2565*2400	1200*2565*2400

Solution code	16	17	18	19	20
Main wiring diagram					
Rated current				1250-2500	1250-2000
Breaker					
Current transformer				3	
Voltage transformer	3	3	3	3	3
Fuse	3	3	3	3	3
Earthing switch	Option	Option	Option		
Surge arrester	Option	Option	3	Option	3
Electrification indicator	Option	Option	Option	Option	Option
Function	P+M	P+M	P+M	B,P+M	B,P+M
Dimension (w*D*H) mm	1200*2565*2400	1200*2565*2400	1200*2565*2400	1200*2565*2400	1200*2565*2400

Classification code of each function in main wiring diagram

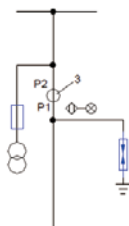
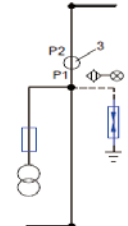
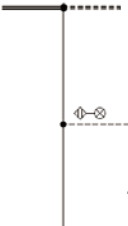
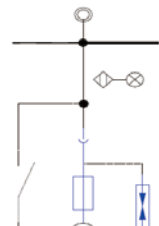
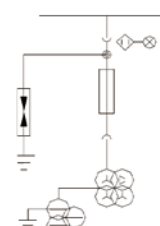
I-Incoming, F-Feeder, D-Divider, B-Bus-tie, R-Bus-riser, M-Measuring, P-Voltage measuring, T-Transformer

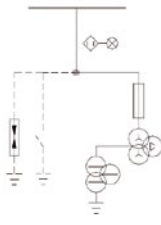
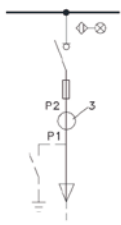
Solution code	21	22	23	24	25	
Main wiring diagram						
Rated current	1250, 1600	1250	1250, 1600			
Main device	Breaker					
	Current transformer	3	3			
	Voltage transformer	3	3		3	
	Fuse	3	3		3	
	Earthing switch				Option	
	Surge arrester	Option	Option	Option	3	3
	Electrification indicator	Option	Option	Option	Option	Option
Function	B.P	B.P	P	P	P	
Dimension (w*D*H) mm	1200*2565*2400	1200*2565*2400	1200*2565*2400	1200*2565*2400	1200*2565*2400	

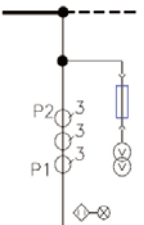
Solution code	26	27	28	29	30
Main wiring diagram					
Rated current		630	630	630	1250
Main device	Breaker				
	Current transformer		3		
	Voltage transformer	4			
	Fuse	3	3	3	3
	Earthing switch	Option	Option		
	Surge arrester	Option	Option	Option	Option
	Electrification indicator	Option	Option	Option	Option
Function	P	T	T	T	B
Dimension (w*D*H) mm	1200*2565*2400	1200*2565*2400	1200*2565*2400	1200*2565*2400	1200*3050*2400

Classification code of each function in main wiring diagram

I-Incoming, F-Feeder, D-Divider, B-Bus-tie, R-Bus-riser, M-Measuring, P-Voltage measuring, T-Transformer

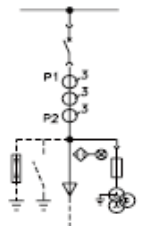
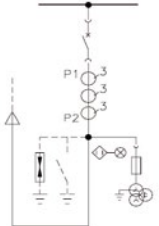
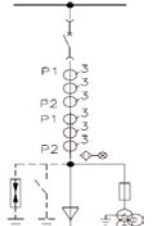
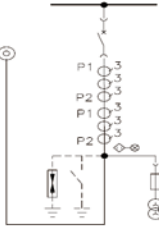
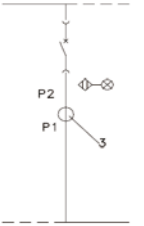
Solution code	31	32	33	34	35
Main wiring diagram					
Rated current	1250-2500	1250-2500	1250-2500	1250-2500	1250
Breaker	VD4/HD4	VD4/HD4	VD4/HD4	VD4/HD4	VD4/HD4
Current transformer	3	3	6	6	3
Voltage transformer	3	3	3	3	
Fuse	3	3	3	3	
Earthing switch	Option	Option	Option	Option	
Surge arrester	Option	Option	Option	Option	
Electrification indicator	Option	Option	Option	Option	Option
Function	I,F	I,F	I,F	T	B
Dimension (W*D*H) mm	1200*3050*2400	1200*3050*2400	1200*3050*2400	1200*3050*2400	1200*3050*2400

7 Assembly of the switchgear at site

In the interests of an optimum installation sequence and the assurance of a high quality standard, site installation of the switchgear should only be carried out by specially trained skilled personnel, or at least supervised and monitored by responsible persons.

7.1 Foundation frame on a concrete floor (Figure 7.1/7.2)

On the commencement of installation at site, the switch room must be completely finished, provided with lighting and site electricity supply, lockable, dry and with facilities for ventilation. All the necessary preparations such as wall openings, ducts, etc., for laying of the power and control cables up to the switchgear must already be completed.

Compliance with the conditions for indoor switch-gear to IEC 62271-200, including the conditions for the “minus 15 indoor” temperature class must be ensured.

The switchgear is preferably to be erected on a foundation frame set on the switch room floor.

The guideline structural data listed below to facilitate a rough calculation of the space required and preliminary planning of the room design for a switchgear project. When the final construction documents are compiled, the binding data supplied by ABB Xiamen Switchgear Co., Ltd. must always be taken into account!

The foundation frame, consisting of one or more parts depending on the size of the switchgear, can be supplied with the switchgear by ABB Xiamen Switchgear Co., Ltd.; it is usually laid by the site personnel and should if possible be aligned and inspected under the supervision of an ABB specialist.

Installation of the foundation frame:

- If the foundation frame consists of several part, bolt these together at the prepared joint locations using links in the specified sequence and so as to achieve a level surface
- Place the foundation frame precisely in the specified position on the concrete floor in accordance with the installation drawing
- Enter jacking screws and place steel strips below them
- Carefully align the foundation frame along the entire surface and to the correct height by screwing the jacking screws down by an appropriate amount and using a levelling instrument

The top edge of the foundation frame should be 5-12 mm above the finished floor surface. This facilitates erection and alignment of the switchgear panels.

e. g. evenness tolerance:

±1 mm within a measuring length of 1 m

e. g. straightness tolerance:

Maximum 1 mm per m, but not more than 2 mm over the entire length of the frame.

The tolerance of the line is 1 mm/m². But the total deviation in the total length of the frame should be no more than 2 mm.

- Make the necessary preparations for perfect earthing of the foundation frame with a 30x4 mm galvanized steel strip. Two connections are necessary for long switchgears
- When the floor topping is applied, carefully back fill the foundation frame, leaving no gaps
- The foundation frame must not be subjected to any injurious impacts or pressures, particularly during the installation phase

If these conditions are not fulfilled, problems during assembly of the switchgear and possibly with movement of the withdrawable parts and opening and closing of the doors cannot be ruled out.

7.1 Guideline structural data for foundation frame on concrete floor (for information only)

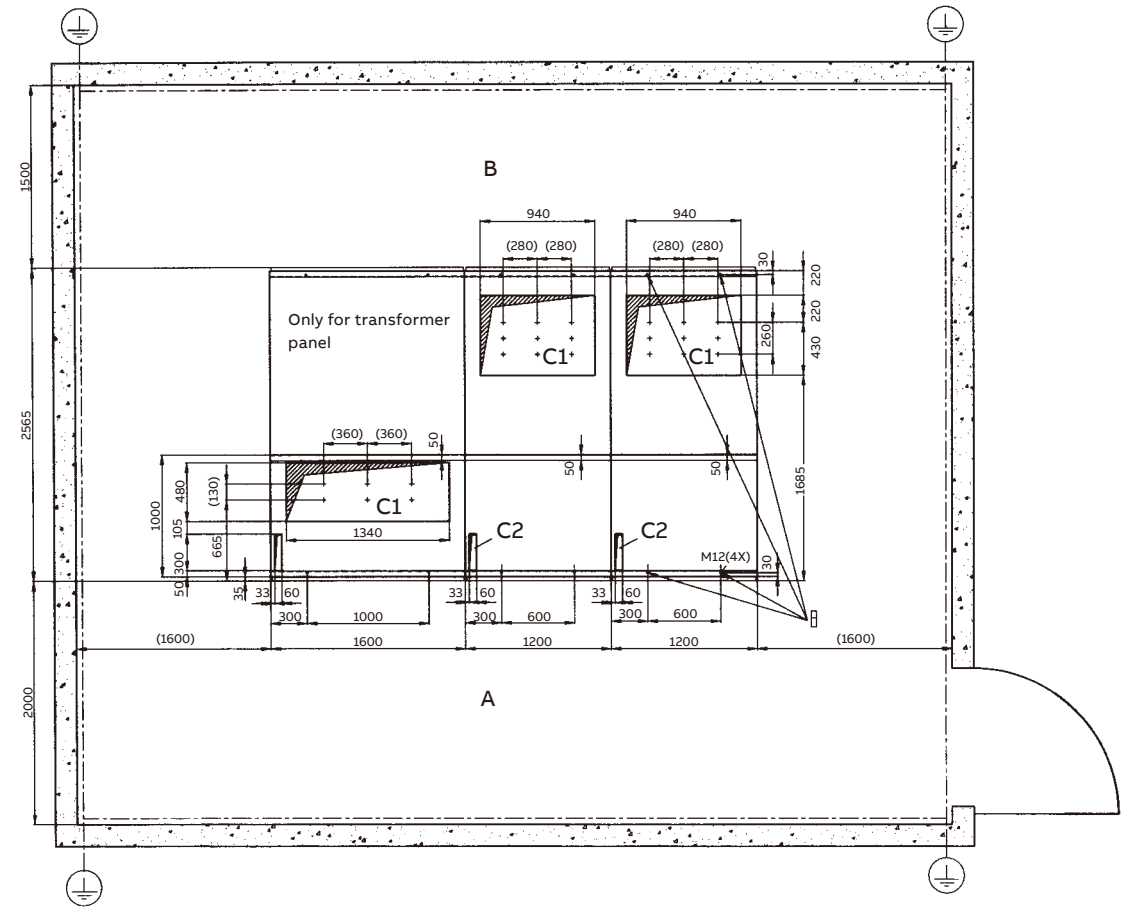

7.1

- A Operator aisle
- B Inspection aisle
- C1 Opening for power cables
- C2 Opening for control cables (instead of individual openings, continuous openings or drilled holes are possible)
- E Points for fixing the switchgear panel on the floor frame

7.2 Section view of Figure 7.1

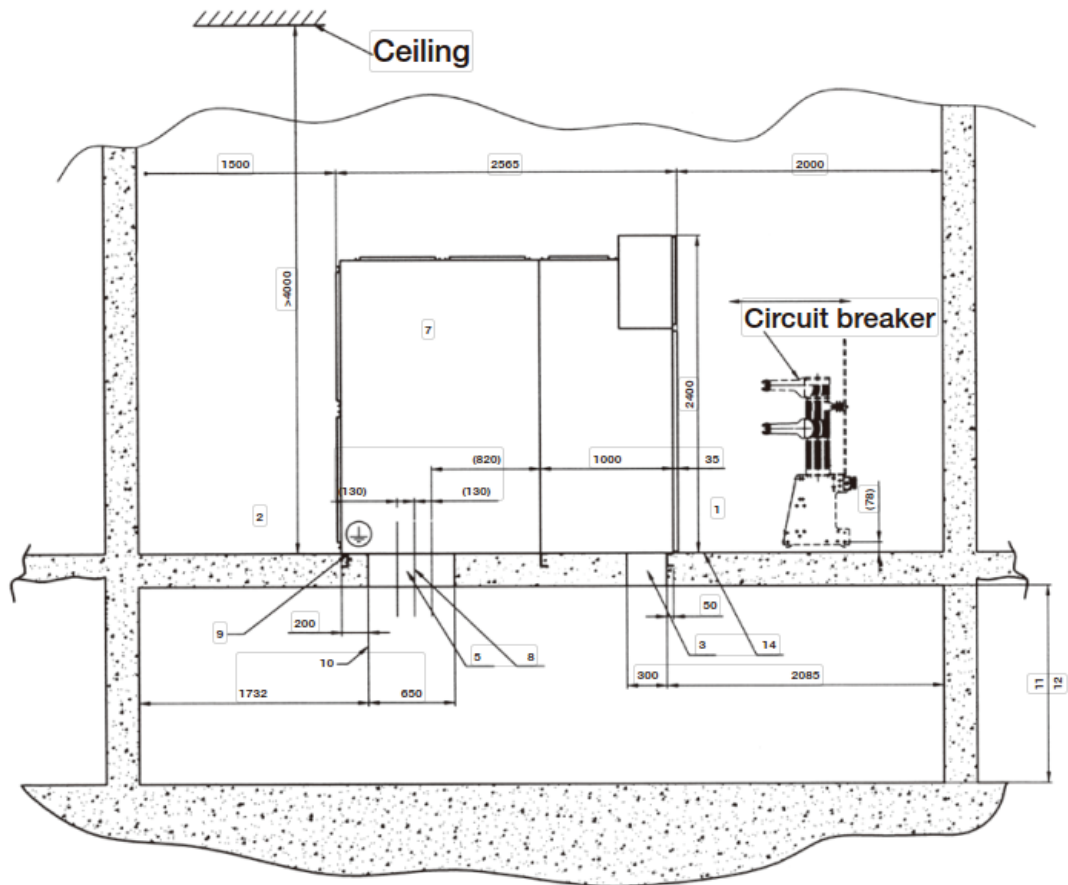

7.2

- 1) Minimum dimensions
- 1 Operator aisle
- 2 Inspection aisle
- 3 Opening for control cables (instead of individual openings, continuous openings or drilled holes are possible)
- 5 Openings for power cables
- 7 Panel type UniGear ZS3.2 ...31.5 kA
- 8 Power cables
- 9 Projecting of floor frame: 5-12 mm above finished floor level
- 10 Conductor to main earthing bar
- 11 Screen 50 mm to 60 mm
- 12 Height of the cable cellar, to be determined by the client
- 14 Guiding ramp, optional (recommended for circuit-breaker insertion)

8 Ordering instruction

When UniGear ZS3.2 is booked, some issue should be made clear in the booking files as below:

- The main wiring scheme, the use and the single line system diagram, rated voltage, rated current, rated short-circuit breaking current, power distribution room layout plan and the arrangement of switch equipment, etc
- If a customer uses a power cable in and out of the cable, the power cable should be specified in the model and the number of roots
- Requirements for switching equipment control, measurement and protection functions, and other requirements for locking and automatic devices
- Model, specification and quantity of the main electrical components in the switchgear
- When switching equipment is used in special conditions, it should be explained in detail
- Other special requirements



ABB Xiamen Switchgear Co., Ltd.

No.885, FangShanXiEr Road, Xiang'an District,
Xiamen, Fujian, 361101

Tel: 0592 602 6033

Fax: 0592 603 0505

ABB China Customer Service Hot Line:

TEL: 800-820-9696 / 400-820-9696

mail: cn-ep-hotline@abb.com

www.abb.com