 TECHNICAL DATA SHEET

ABB cable glands – STE Star Teck® extreme series

Industrial applications



The STAR TECK® STE fitting for Teck, MC and ACWU - its innovative design provides quality engineering, easier installation and helps achieve safer, more reliable terminations in challenging industrial environments. The STE offers a broader cable range per fitting compared to the regular ST series.

Certifications / Standards:

Features & Benefits:

- Excellent pullout strength
- Robust metallic construction
- Quick and easy installation without disassembly
- Extended clamping range taking
- Provides grounding continuity of cable armor
- Splined gland and gripping features for ease of installation
- Removable armor-stop for greater cable ranges

Applications:

- Provides means for passing jacketed metal clad cables through a bulkhead or enclosure in industrial and hazardous areas
- Oil and gas Industry, chemical and industrial markets
- Construction and installation zones where metal clad cables are specified
- Suitable for cable types:
 - Jacketed Teck and ACWU
 - Armored control and instrument (ACIC)
 - Type MC: Jacketed corrugated metal clad (aluminum and steel)

Material:

- Copper free aluminum
- Zinc plated steel option

Environmental ratings:
Working Temperature:

- Normal use -40 to +90°C (-40 to +194°F)

Ingress protection:

- Type 4 / 4X

Chemical resistance guide:

- See publication TDS000081

Conforms to:

- CSA E60079-0/-7
 - Ex e II
- CSA C22.2 No.25/-174
 - Class I Div1 ABCD Class II Div1 EFG Class III Div1
 - Refer to CEC for specific applications
- UL2279
 - Class I, Zone 1, AEx e II
- UL514B/50 and CSA C22.2-18.3/-94
 - Wet and Dry Locations
 - Suitable for Class I Div 2, Class II Div 2 and Class III location per NEC
- RoHS (Restriction of Hazardous Substances Directive) 2011/65/EU Incorporating 2015/863 amendment to Annex II

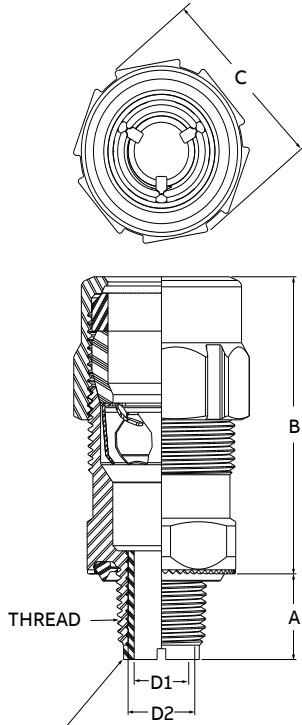

REMOVABLE ARMOR STOP, SEE
"D" DIMENSIONS
D1 = WITH ARMOR STOP
D2 = WITHOUT ARMOR STOP

Product selection

Part no:	Thread (NPT)	Range over jacket		Range over armour		Nominal dimensions				
		Min	Max	Min	Max	A	B	C	D1	D2
STE050 DATA	1/2	12.70	17.78	10.41	15.49	15.75	53.34	34.54	9.53	13.08
		(0.500)	(0.700)	(0.410)	(0.610)	(0.620)	(2.100)	(1.360)	(0.375)	(0.515)
STE050	1/2	15.24	25.02	13.21	22.73	15.75	64.01	41.40	12.83	15.67
		(0.600)	(0.985)	(0.520)	(0.895)	(0.620)	(2.520)	(1.630)	(0.505)	(0.617)
STE075	3/4	21.84	30.61	19.81	28.58	16.00	72.14	52.83	16.38	20.80
		(0.860)	(1.205)	(0.780)	(1.125)	(0.630)	(2.840)	(2.080)	(0.645)	(0.819)
STE100	1	24.13	34.93	22.10	32.89	19.94	76.71	58.42	19.94	26.52
		(0.950)	(1.375)	(0.870)	(1.295)	(0.785)	(3.020)	(2.300)	(0.785)	(1.044)
STE125	1-1/4	29.21	41.28	25.15	37.21	20.57	101.85	71.63	24.64	31.75
		(1.150)	(1.625)	(0.990)	(1.465)	(0.810)	(4.010)	(2.820)	(0.970)	(1.250)
STE150	1-1/2	36.58	49.91	32.51	45.85	20.96	108.97	82.55	32.00	39.67
		(1.440)	(1.965)	(1.280)	(1.805)	(0.825)	(4.290)	(3.250)	(1.260)	(1.562)
STE200	2	46.36	60.33	42.29	56.26	21.84	104.65	91.44	41.78	50.67
		(1.825)	(2.375)	(1.665)	(2.215)	(0.860)	(4.120)	(3.600)	(1.645)	(1.995)
STE250	2-1/2	57.53	72.14	53.47	68.07	32.51	144.02	120.65	52.71	61.57
		(2.265)	(2.840)	(2.105)	(2.680)	(1.280)	(5.670)	(4.750)	(2.075)	(2.424)
STE300	3	67.82	83.06	64.64	79.88	33.66	146.81	137.16	64.29	73.41
		(2.670)	(3.270)	(2.545)	(3.145)	(1.325)	(5.780)	(5.400)	(2.531)	(2.890)
STE350	3-1/2	81.79	98.30	78.49	92.46	35.31	145.80	149.86	77.85	86.72
		(3.220)	(3.870)	(3.090)	(3.640)	(1.390)	(5.740)	(5.900)	(3.065)	(3.414)
STE400	4	93.09	110.24	90.17	107.32	35.31	147.07	162.56	89.54	99.42
		(3.665)	(4.340)	(3.550)	(4.225)	(1.390)	(5.790)	(6.400)	(3.525)	(3.914)

To order steel version, add suffix "S". Ex: STE050S

Contact your representative for availability

Dimensions may vary depending on material selection.

Note: Product must be installed in accordance with applicable national and local electrical codes.

