

INSTALLATION, OPERATION AND MAINTENANCE MANUAL

TPME and TPHE NSBX and NSWM series

Integral SPDs for OEM factory installation



- Model numbers covered by this manual are TPME and TPHE, UL Type 2 model types ending with part number suffixes of NSBX and NSWM. (Example: TPHE277Y20NSBX)
- Model types are also available with a UL Type 1 rating. These models will be labeled with the part number suffix of T1.

Guide to installation and assistance

WARNING

The SPD warranty is voided if the unit is damaged as a result of improper installation. Improper installation or misapplication may result in serious personal injury or damage to the electrical system. Read the complete installation instructions before proceeding with installation.

La garantie du SPD est annulée si l'appareil est endommagé à la suite d'une mauvaise installation. Une mauvaise installation, ou utilisation, peut entraîner des blessures graves ou des dégâts au système électrique. Lisez les instructions d'installation en intégralité avant de procéder à l'installation.

WARNING

The equipment covered by these instructions should be installed and serviced only by competent qualified personnel utilizing proper safety practices and procedures. These instructions are written for such personnel and are not intended as a substitute for adequate training and experience in safe procedures for this type of equipment.

L'équipement couvert par ces instructions doit être installé et entretenu uniquement par un personnel compétent et qualifié, utilisant des pratiques et des procédures de sécurité appropriées. Ces instructions sont rédigées à l'intention de ce personnel et ne sauraient se substituer à une formation adéquate et à une expérience des procédures de sécurité pour ce type d'équipement.

WARNING

Remove all power to the electrical panel before installing or servicing the SPD. All work must be performed by licensed and qualified personnel. Follow applicable electrical codes and regulations for the country/location in which the unit is being used.

Coupez l'alimentation du panneau électrique avant d'installer ou de procéder à l'entretien du SPD. Tous les travaux doivent être effectués par un personnel qualifié et agréé. Respectez les codes et réglementations électriques en vigueur dans le pays / lieu où l'appareil est utilisé.

WARNING

Do not HIPOT the SPD unit or the electrical system to which the SPD unit is connected without disconnecting the SPD unit's conductors, including phases, neutral and ground.

Ne procédez PAS à des ESSAIS DE RIGIDITÉ DIÉLECTRIQUE sur le SPD ou le système électrique auquel il est connecté sans déconnecter les conducteurs des SPD, y compris les phases, le neutre et la terre.

WARNING

Check to ensure that a proper bond is installed between neutral and ground at the transformer upstream from all 3-phase wye, 3-phase high-leg or 2-phase SPD devices. If the transformer is not accessible, check the main service disconnect/panel for the NG bond. Lack of a proper bond may damage the SPD and void the warranty. Failure to provide this bond, as required per article 250.30 of the National Electrical Code, can result in elevated phase-to-ground source voltage potentials. These voltages can cause damage to electrical equipment as well as safety hazards including fire, electrical shock, serious injury or death.

Vérifiez qu'une liaison correcte est installée entre le neutre et la terre au niveau du transformateur en amont de tous les SPD triphasés en étoile, triphasés en triangle ou biphasés. Si le transformateur n'est pas accessible, vérifiez la liaison NG sur le sectionneur / panneau de service principal. L'absence d'une liaison appropriée peut endommager le SPD et annuler la garantie. L'absence de cette liaison, telle que requise par l'article 250.30 du Code national de l'électricité, peut entraîner des potentiels de tension élevés entre la phase et la terre. Ces tensions peuvent causer des dégâts aux équipements électriques ainsi que des risques en matière de sécurité, notamment des incendies, des chocs électriques, des blessures graves ou la mort.

WARNING

Installation by person with electrotechnical expertise only.

WARNUNG!

Installation nur durch elektrotechnische Fachkraft.

AVERTISSEMENT!

Installation uniquement par des personnes qualifiées électrotechnique.

¡ADVERTENCIA!

La instalación deberá ser realizada únicamente por electricistas especializados.

Pre-installation requirements

Prior to energization of the SPD, it is critical that the following items have been addressed. Do not attempt to energize the SPD or continue with the installation if all these conditions have not been met, or are unknown.

1. System configuration and voltage



Prior to installation, ensure the system configuration and voltage is equivalent to the SPD unit being installed.

Avant l'installation, assurez-vous que la configuration et la tension du système sont équivalentes à celles du SPD en cours d'installation.

The SPD model number can be found on the UL label affixed to the SPD enclosure. The SPD selection can be verified by comparing the model number to the correct electrical system described in the "VOLTAGE RATINGS AND POWER SOURCE CONFIGURATIONS" chart.

2. System grounding and bonding

Verify that an NEC (National Electrical Code) compliant X0 bond has been made at the upstream transformer or other separately derived system that feeds the SPD. Per NEC Article 250.30, this bond must be in place on all 3-Phase WYE, 3-Phase Hi-Leg Delta and Single-Phase Split-Systems. Refer to diagram "EXAMPLE OF AN NEC COMPLIANT GROUNDING ARRANGEMENT FOR A SEPERATELY DERIVED SYSTEM" for an example of an installation that complies with these NEC recommendations.

Verify that there have not been multiple instances of neutral-to-ground bonds on the electrical system. These bonds, while either intentional or accidental, result in ground currents that can create differential voltage potentials between neutral and ground. Redundant neutral-to-ground connections can result in damage to the SPD and are in violation of the NEC.

3. SPD installation on ungrounded power systems

Ungrounded power systems are inherently unstable and can produce excessively high line-to-ground voltages during certain fault conditions. During these fault conditions, any electrical equipment, including an SPD, may be subjected to voltages that exceed their designed ratings. This information is being provided to the user so that an informed decision can be made before installing any electrical equipment on an ungrounded power system.

4. SPD location / primary overcurrent protection

Per the National Electrical Code (NEC Article 285), Type 2 SPDs are allowed to be placed on the load side of the main service breaker/fuse.

Pre-installation requirements

Table 1: Voltage ratings and power source configurations

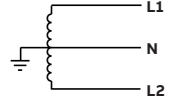
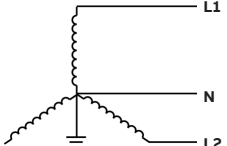
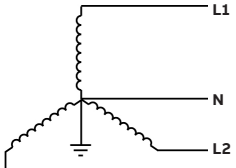
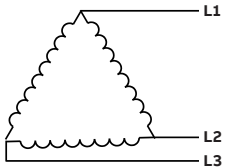
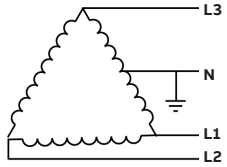
Model	Nominal voltage (50/60Hz)	Maximum continuous operating voltage (MCOV)	System type	Source configuration
TPME/TPHE 120S	120/208-240 V	150 V (L-N/L-G)	Single-phase 3 wire + ground	
			Dual-phase 3 wire + ground	
TPME/TPHE120Y	120/208 V	150 V (L-N/L-G)	Three-phase WYE, 4 wire + ground	
TPME/TPHE220Y	220/380 V	320 V (L-N/L-G)		
TPME/TPHE240Y	240/415 V	320 V (L-N/L-G)		
TPME/TPHE277Y	277/480 V	320 V (L-N/L-G)		
TPME/TPHE347Y	347/600 V	420 V (L-N/L-G)		
TPME / TPHE 240D	240 V	270 V (L-G)	Three-phase Delta, 3 wire	
TPME / TPHE 480D	480 V	550 V (L-G)		
TPME / TPHE 240H	120 / 240 V	150 V (L-N / L-G) Phase A & C	Three-phase Delta Hi-Leg, 4 wire + ground	

Pre-installation requirements

Example of an NEC compliant grounding arrangement for a separately derived system

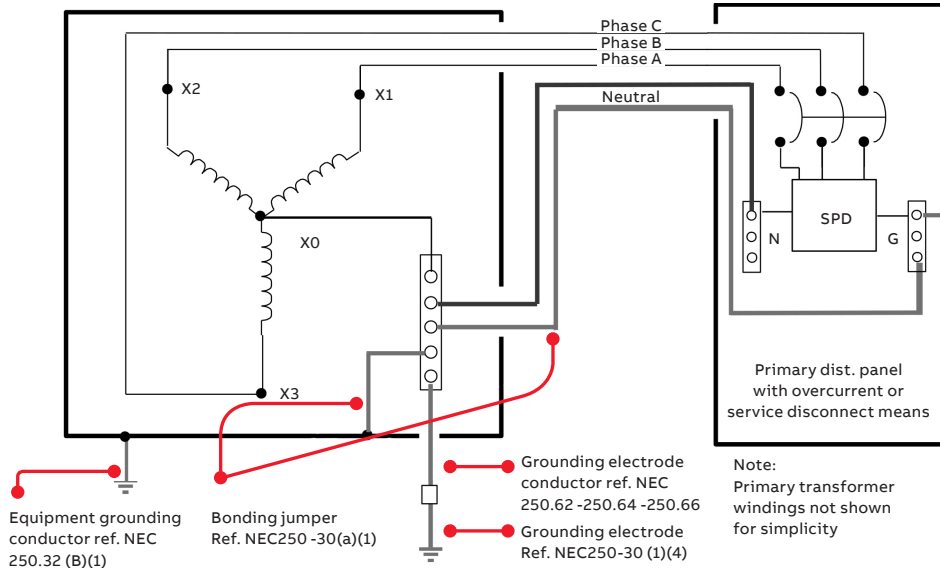

The illustration shown provides a recommended method for grounding a separately derived power system, per the National Electrical Code, Article 250.30. Please check with the local municipality or governing authority for additional codes or other approved regulatory requirements before attempting to configure any electrical power distribution system.

Installation



WARNING

Power must be proven disconnected before starting installation, inspection or maintenance. Failure to do so may cause serious injury, death and/or property damage.

Il doit être prouvé que l'alimentation est déconnectée avant de commencer l'installation, l'inspection ou l'entretien. Le non-respect de cette précaution peut entraîner des blessures graves, la mort et/ou des dégâts matériels.

The SPDs described in this manual are intended to arrive at the job site as factory-mounted and wired into OEM electrical panels or gear. When receiving the SPD on site as OEM factory preinstalled, please begin at step number 5 below.

Installation steps 1–4, shown below (appended with “OEM”), are intended to provide guidance to OEMs for factory installation considerations.

Before attempting installation, make sure that the pre-installation requirements of this manual have been satisfied. If the status of the pre-installation requirements are not known, do not attempt to continue.

1. Mounting (OEM)

The SPD is configured with a mounting base to allow for secure attachment to the equipment frame. The SPD can be installed in any orientation; however, special consideration should be given to allow for periodic inspection of the diagnostic display panel. The SPD should be installed as close to the power source as possible to provide the best SPD performance. The SPD mounting base should always be secured to a structure that is intended to be grounded.

2. Power connections (OEM)

Mechanical terminals are provided on the SPD for connection to the electrical power system. These terminals will accommodate #14 to 2/0 AWG stranded copper conductors. The minimum recommended wire size for the SPD is #6 AWG. See following diagram for terminal location and identification.

Installation

3. Wire routing (OEM)

The length of wiring to the SPD must be kept at a minimum. For the best performance, ABB recommends maintaining 36" of length or less for each conductor (including neutral and/or ground). Wire lengths should be short, straight runs between the SPD and power source. Wiring impedance can be further reduced by twisting the phase, neutral and ground conductors together and routing them in the same raceway or channel. Always avoid sharp bends when routing SPD connecting conductors.

4. Circuit breaker (OEM)

A dedicated circuit breaker is not required for TPME or TPHE models. If a dedicated branch breaker is to be used to connect the SPD to the power system, ABB recommends a 60 A or higher rated breaker.

5. Remote alarm contacts

Remote alarm monitoring contacts are provided on all SPD model types covered by this manual. If this type of monitoring is desired, refer to the following diagram for the location and pin configuration of these contacts. The contacts are dry, form C type, rated 120 V AC, 1 A (30 V DC, 2 A) maximum. Once the SPD has been energized and is operating as intended, the alarm contacts will switch to "normal status." The contacts will only change back to "alarm status" if there is a failure within the SPD suppression circuitry, or if power has been disconnected from the SPD. Allowing the remote alarm contacts remain unconnected will not affect the performance or integrity of the SPD.

6. SPD disconnect switch

Not provided on NSBX or NSWM models.

7. Pre-energization check

Once all of the pre-installation conditions have been met and the SPD has been installed, the SPD can now be energized. For SPD operational status, refer to Operation and Maintenance sections.

Power terminals and remote alarm locations

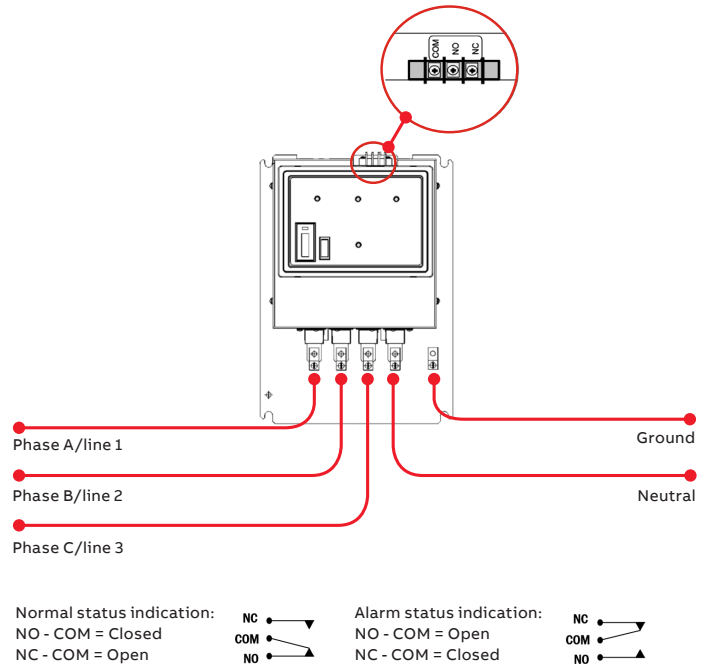

The illustration above represents the SPD in a vertical orientation. Other orientations are possible depending on the type of equipment in which the SPD is installed. The SPD features will be the same regardless of application.

NOTICE

Hi-Leg Delta power systems:
 TPME240H and TPHE240H SPD model types are intended for Hi-Leg Delta systems and are configured with Phase B as the intended Hi-Leg connection point. Attempting to connect the SPD Phase C or Phase A conductor to the system Hi-Leg will result in immediate SPD failure.

Installation

WARNING

Upon energization of the SPD, if any of the lamps or alarms indicates an abnormal condition, power should be disconnected promptly from the SPD. The electrical system should be inspected and the pre-installation requirements should be validated. Do not attempt to leave power applied to the SPD, or re-energize the SPD in the event of an alarm condition.

Lors de la mise sous tension du SPD, si l'une des lampes ou des alarmes indique une condition anormale, l'alimentation du SPD doit être coupée rapidement. Le système électrique doit être inspecté et les exigences de pré-installation doivent être validées. N'essayez pas de laisser le SPD sous tension, ou de le remettre sous tension en cas d'alarme.

Operation

After applying power to the SPD, verify that the protection monitoring circuits are functioning correctly. If all status alarms indicate “normal,” the SPD has been successfully installed and is operational.

SPD display panel

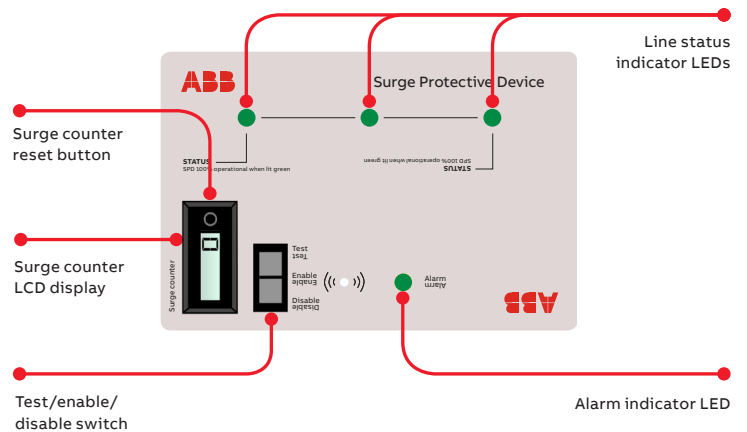

1. Line status indicator LEDs

The green line status LEDs provide visual indication of SPD health status. As long as the SPD is connected to the electrical system supply voltage and the SPD suppression circuitry is functional, the line status indicators will be illuminated green. There is one green indicator per each protected phase.

2. Alarm status indicator LEDs

When illuminated, the red alarm status indicator LED will provide notification of an SPD failure condition. Verify the alarm status indicator is not illuminated upon startup.

3. Remote alarm contacts

Remote alarm contacts are available to remotely monitor the health status of the SPD. An alarm condition will result in a status change of the contacts. These contacts do not affect the performance of the SPD and are not required to be connected for the SPD to function as intended. (See alarm contact for details)

4. Test / enable / disable switch

- Enable position — This is the normal position for the tri-position switch. In the enable position, the audible alarm will sound in the event of a SPD failure mode.
- Disable position — This position will silence the audible alarm if desired. The disable switch will not disable or disconnect the SPD from the electrical power system.

Operation

4. Test / enable / disable switch (cont.)

- Test position — The test switch provides a quick diagnostic status of the audible alarm, alarm status indicator and remote alarm contacts. When pressed, the audible alarm will sound, the alarm lamp will illuminate, and the remote contacts will change state. The “test” position is momentary. Once pressed, the switch will automatically reset to the enable position upon release.

Maintenance

ABB does not provide a specific schedule for preventative maintenance as conditions will vary based on location and the environmental factors presented at each installation site. However, periodic inspections should be scheduled to verify that the SPD does not indicate a failure mode. Inspections should also be made to check the integrity of the electrical supply connections to the SPD to ensure continued reliable performance.

The unit's heavy-duty construction is designed to provide years of uninterrupted service.

The unit contains no serviceable parts.

L'unité ne contient aucune pièce réparable.

NOTICE

In the event of an SPD alarm condition, do not attempt to dis-assemble the SPD to replace fusing or other components. The SPD contains thermally protected MOVs that will only open when the SPD has failed in a non-serviceable condition. The entire SPD must be replaced.

En cas de condition d'alarme du SPD, n'essayez pas de démonter le SPD pour remplacer les fusibles ou d'autres composants. Le SPD contient des MOV protégés thermiquement qui ne s'ouvrent que lorsque le SPD tombe en panne et ne fonctionne plus. L'ensemble du SPD doit être remplacé.

ABB Inc.
305 Gregson Drive
Cary, NC 27511

We reserve the right to make technical changes or modify the contents of this document without prior notice. With regard to purchase orders, the agreed particulars shall prevail. ABB Inc. does not accept any responsibility whatsoever for potential errors or possible lack of information in this document.

5. Surge counter LCD

The surge counter will sense and record transient surge events that have been mitigated by the SPD. The counter has been designed to detect transients that exceed the peak sine wave by more than 70%. If desired, the surge counter display can be reset to zero at any time by pressing the reset button located on the LCD display.

Servicing/troubleshooting

Should a condition occur that results in premature failure of the SPD, the integral SPD suppression thermal fusing will safely interrupt current flow through the SPD without disrupting power to the protected equipment. This will remove the SPD from the power system, and the load equipment will remain unprotected from subsequent surge activity until the SPD is replaced.

If a change in operational status/alarm indication occurs, a qualified (licensed) electrician should inspect the electrical system to verify electrical system integrity. If the SPD remains in alarm after inspection/corrections have been made, the SPD should be replaced.