

ABB industrial drives

# Firmware manual

## Standard pump control program for ACQ810 drives



Power and productivity  
for a better world™



## List of related manuals

### Drive hardware manuals and guides

### Code (English)

---

<i>ACQ810-04 drive modules (1.1 to 45 kW, 1 to 60 hp) hardware manual</i>	<a href="#">3AUA0000055159</a>
<i>ACQ810-04 drive modules (55 to 160 kW, 75 to 200 hp) hardware manual</i>	<a href="#">3AUA0000055161</a>
<i>ACQ810-04 drive modules (200 to 400 kW, 250 to 600 hp) hardware manual</i>	<a href="#">3AUA0000055155</a>
<i>ACQ810-04 drive modules (200 to 500 kW, 300 to 700 hp) hardware manual</i>	<a href="#">3AUA0000120538</a>
<i>Safe torque off function for ACSM1, ACS850 and ACQ810 drives application guide</i>	<a href="#">3AFE68929814</a>

### Drive firmware manuals and guides

---

<i>ACQ810 standard pump control program firmware manual</i>	<a href="#">3AUA0000055144</a>
<i>ACQ810-04 drive modules start-up guide</i>	<a href="#">3AUA0000055159</a>
<i>Application programming for ACS850 and ACQ810 drives application guide</i>	<a href="#">3AUA0000078664</a>

### Option manuals and guides

---

*Manuals and quick guides for I/O extension modules, fieldbus adapters, etc.*

You can find manuals and other product documents in PDF format on the Internet. See section [Document library on the Internet](#) on the inside of the back cover. For manuals not available in the Document library, contact your local ABB representative.



[ACQ810 manuals](#)

# Firmware Manual

ACQ810 Standard Pump Control Program

Table of contents





# Table of contents

---

## 1. About the manual

What this chapter contains .....	11
Compatibility .....	11
Safety instructions .....	11
Reader .....	11
Contents .....	12
Terms and abbreviations .....	12

## 2. The ACQ810 control panel

What this chapter contains .....	15
Features .....	15
Installation .....	16
Mechanical installation .....	16
Electrical installation .....	16
Layout .....	17
Status line .....	18
Operating instructions .....	19
Basics of operation .....	19
List of tasks .....	20
Help and panel version – Any mode .....	21
Basic operations – Any mode .....	22
Output mode .....	23
Parameters .....	25
Assistants .....	32
Changed Parameters .....	33
Fault Logger .....	35
Time & Date .....	37
Parameter Backup .....	39
I/O Settings .....	47
Reference Edit .....	49
Drive Info .....	50
Parameter Change Log .....	51

## 3. Control locations

What this chapter contains .....	53
Local control vs. external control .....	54
Local control .....	54
External control .....	55

---



## 4. Program features

What this chapter contains .....	57
Drive configuration and programming .....	57
Programming via parameters .....	58
Application programming .....	58
Pump control features .....	60
PID control .....	60
Sleep function .....	61
Soft pipefill .....	63
Autochange .....	64
Flow calculation .....	65
Pump cleaning .....	66
Protective functions .....	66
Quick ramp mode .....	68
Control interfaces .....	70
Programmable analog inputs .....	70
Programmable analog outputs .....	70
Programmable digital inputs and outputs .....	70
Programmable I/O extensions .....	71
Programmable relay outputs .....	71
Fieldbus control .....	71
Motor control .....	73
Constant speeds .....	73
Critical speeds .....	73
Speed controller tuning .....	73
Scalar motor control .....	75
User-definable load curve .....	76
User-definable U/f curve .....	77
Flux braking .....	78
Application control .....	79
Application macros .....	79
Timers .....	79
DC voltage control .....	81
Overvoltage control .....	81
Undervoltage control .....	81
Voltage control and trip limits .....	82
Safety and protections .....	83
Emergency stop .....	83
Thermal motor protection .....	83
Programmable protection functions .....	84
Automatic fault reset .....	85
Diagnostics .....	86
Energy savings calculator .....	86
Energy consumption monitoring .....	86
Signal supervision .....	86
Maintenance counters .....	87
Load analyzer .....	88



Miscellaneous .....	89
Backup and restore of drive contents .....	89
Data storage parameters .....	90
Drive-to-drive link .....	91

## 5. Application macros

What this chapter contains .....	93
General .....	93
Factory default macro .....	94
Description and typical application .....	94
Default settings .....	94
Default control connections for the Factory default macro .....	95
External control macro .....	96
Description and typical application .....	96
Default settings .....	96
Default control connections for the External control macro .....	97
Hand/Auto control macro .....	98
Description and typical application .....	98
Default settings .....	98
Default control connections for the Hand/Auto control macro .....	99
TRAD (Traditional pump) control macro .....	100
Description and typical application .....	100
Default settings .....	100
Default control connections for the TRAD macro .....	101
Application examples .....	102
Level control macro .....	108
Description and typical application .....	108
Default settings .....	109
Default control connections for the Level control macro .....	110
Multipump control macro .....	111
Description and typical application .....	111
Default settings .....	112
Default control connections for the Multipump control macro .....	113
Pressure sensor connection examples .....	114

## 6. Parameters

What this chapter contains .....	115
Terms and abbreviations .....	115
Summary of parameter groups .....	116
Parameter listing .....	118
01 Actual values .....	118
02 I/O values .....	119
03 Control values .....	129
04 Appl values .....	129
05 Pump values .....	130
06 Drive status .....	133
08 Alarms & faults .....	138
09 System info .....	143
10 Start/stop/dir .....	144



## 8 Table of contents

11 Start/stop mode	150
12 Operating mode	152
13 Analogue inputs	153
14 Digital I/O	159
15 Analogue outputs	170
16 System	176
19 Speed calculation	180
20 Limits	182
21 Speed ref	184
22 Speed ref ramp	186
23 Speed ctrl	188
25 Critical speed	196
26 Constant speeds	197
27 Process PID	199
28 Procact sel	203
29 Setpoint sel	205
30 Fault functions	207
31 Motor therm prot	209
32 Automatic reset	214
33 Supervision	214
34 User load curve	218
35 Process variable	220
36 Timed functions	226
38 Flux ref	231
40 Motor control	232
44 Maintenance	234
45 Energy optimising	240
47 Voltage ctrl	241
49 Data storage	242
50 Fieldbus	242
51 FBA settings	245
52 FBA data in	246
53 FBA data out	247
56 Panel display	247
58 Embedded Modbus	249
64 Load analyzer	253
75 Pump logic	256
76 MF communication	268
77 Pump sleep	271
78 Pump autochange	274
79 Level control	279
80 Flow calculation	284
81 Pump protection	288
82 Pump cleaning	296
83 Energy monitoring	299
94 Ext IO conf	300
95 Hw configuration	300
97 User motor par	300
99 Start-up data	301





## 7. Additional parameter data

What this chapter contains .....	307
Terms and abbreviations .....	307
Fieldbus addresses .....	308
Pointer parameter format in fieldbus communication .....	308
32-bit integer value pointers .....	308
32-bit integer bit pointers .....	309
Parameter groups 1...9 .....	310
Parameter groups 10...99 .....	314

## 8. Fault tracing

What this chapter contains .....	335
Safety .....	335
How to reset .....	335
Fault history .....	336
Alarm messages generated by the drive .....	336
Fault messages generated by the drive .....	344

## 9. Control through the embedded fieldbus interface

What this chapter contains .....	355
System overview .....	356
Connecting the fieldbus to the drive .....	357
Setting up the embedded fieldbus interface .....	358
Setting the drive control parameters .....	360
Basics of the embedded fieldbus interface .....	362
Control word and Status word .....	363
References .....	363
Actual values .....	363
Data inputs/outputs .....	363
About the EFB communication profiles .....	364
ABB Drives classic profile and ABB Drives enhanced profile .....	365
Control word for the ABB Drives profiles .....	365
Status word for the ABB Drives profiles .....	367
State transition diagram for the ABB Drives profiles .....	369
References for the ABB Drives profiles .....	370
Actual values for the ABB Drives profiles .....	371
Modbus register addresses for the ABB Drives classic profile .....	372
Modbus register addresses for the ABB Drives enhanced profile .....	373
DCU 16-bit profile .....	374
Control and Status words for the DCU 16-bit profile .....	374
Status word for the DCU 16-bit profile .....	374
State transition diagram for the DCU 16-bit profile .....	374
References for the DCU 16-bit profile .....	374
Actual signals for the DCU 16-bit profile .....	374
Modbus register addresses for the DCU 16-bit profile .....	375
DCU 32-bit profile .....	376
Control and Status words for the DCU 32-bit profile .....	376
Status word for the DCU 32-bit profile .....	376



## 10 Table of contents

State transition diagram for the DCU 32-bit profile .....	376
References for the DCU 32-bit profile .....	377
Modbus register addresses for the DCU 32-bit profile .....	379
Modbus function codes .....	380
Modbus exception codes .....	381

### **10. Control through a fieldbus adapter**

What this chapter contains .....	383
System overview .....	384
Setting up communication through a fieldbus adapter module .....	385
Drive control parameters .....	387
The fieldbus control interface .....	388
The Control Word and the Status Word .....	389
Actual values .....	389
FBA communication profile .....	389
Fieldbus references .....	390
State diagram .....	391



### **11. Control block diagrams**

What this chapter contains .....	393
Speed feedback .....	394
Speed reference chain .....	395
Speed error handling .....	396
Torque reference modification, operating mode selection .....	397
Process PID control setpoint and actual value selection .....	398
Direct torque control .....	399

### **Further information**

Product and service inquiries .....	401
Product training .....	401
Providing feedback on ABB Drives manuals .....	401
Document library on the Internet .....	401

---



# About the manual

---

## What this chapter contains

The chapter describes the contents of the manual. It also contains information on the compatibility, safety and intended audience.

## Compatibility

The manual is compatible with:

- ACQ810 standard pump control program version UIFQ2200 or later
- ACQ810 synchronous reluctance motor control program (option +N7502) version UIFQ2210 or later.

## Safety instructions

Follow all safety instructions delivered with the drive.

- Read the **complete safety instructions** before you install, commission, or use the drive. The complete safety instructions are given at the beginning of the *Hardware Manual*.
- Read the **software function specific warnings and notes** before changing the default settings of the function. For each function, the warnings and notes are given in this manual in the section describing the related user-adjustable parameters.

## Reader

The reader of the manual is expected to know the standard electrical wiring practices, electronic components, and electrical schematic symbols.

---

## Contents

The manual consists of the following chapters:

- [The ACQ810 control panel](#) provides a description and instructions for use of the control panel.
- [Control locations](#) describes the control locations and operation modes of the drive.
- [Program features](#) contains descriptions of the features of the ACQ810 standard program.
- [Application macros](#) contains a short description of each macro together with a connection diagram.
- [Parameters](#) describes the parameters of the drive.
- [Additional parameter data](#) contains further information on the parameters.
- [Fault tracing](#) lists the alarm (warning) and fault messages with possible causes and remedies.
- [Control through the embedded fieldbus interface](#) describes the communication to and from a fieldbus network using the embedded fieldbus interface.
- [Control through a fieldbus adapter](#) describes the communication to and from a fieldbus network using an optional fieldbus adapter module.
- [Control block diagrams](#) contains a graphical representation of the control program.

## Terms and abbreviations

Term/abbreviation	Definition
AI	Analog input; interface for analog input signals
AO	Analog output; interface for analog output signals
DC link	DC circuit between rectifier and inverter
DI	Digital input; interface for digital input signals
DIO	Digital input/output; interface for digital input or output signals
DO	Digital output; interface for digital output signals
DTC	Direct torque control
EFB	Embedded fieldbus
FBA	Fieldbus adapter
FIO-01	Optional digital I/O extension module
FIO-11	Optional analog I/O extension module
FIO-21	Optional analog/digital I/O extension module
FIO-31	Optional digital I/O extension module
FDNA-0x	Optional DeviceNet adapter
FENA-0x	Optional Ethernet/IP adapter
FLON-0x	Optional LONWORKS <sup>®</sup> adapter
FPBA-0x	Optional PROFIBUS DP adapter

Term/abbreviation	Definition
FSCA-0x	Optional Modbus adapter
IGBT	Insulated gate bipolar transistor; a voltage-controlled semiconductor type widely used in inverters due to their easy controllability and high switching frequency
I/O	Input/Output
ID run	Motor identification run. During the identification run, the drive will identify the characteristics of the motor for optimum motor control.
JCU	Control unit of the drive module. The JCU is installed on top of the power unit. The external I/O control signals are connected to the JCU, or optional I/O extensions mounted on it.
JMU	Memory unit attached to the control unit of the drive
JPU	<i>Power unit</i> ; see the definition below.
LSB	Least significant bit
LSW	Least significant word
MSB	Most significant bit
MSW	Most significant word
Parameter	User-adjustable operation instruction to the drive, or signal measured or calculated by the drive
PI controller	Proportional-integral controller
PID controller	Proportional–integral–derivative controller. Drive speed control is based on PID algorithm.
PLC	Programmable logic controller
Power unit	Contains the power electronics and connections of the drive module. The JCU is connected to the power unit.
PTC	Positive temperature coefficient
RFG	Ramp Function Generator
RO	Relay output; interface for a digital output signal. Implemented with a relay.
STO	Safe torque off
UIFQ xxxx	Firmware of the ACQ810 drive
UPS	Uninterruptible power supply; power supply equipment with battery to maintain output voltage during power failure





# The ACQ810 control panel

---

## What this chapter contains

This chapter describes the features and operation of the ACQ810 control panel.

The control panel can be used to control the drive, read status data, and adjust parameters.

## Features

- alphanumeric control panel with an LCD display
  - copy function – parameters can be copied to the control panel memory for later transfer to other drives or for backup of a particular system.
  - context sensitive help
  - real time clock.
-

## Installation

### ■ Mechanical installation

For mounting options, see the *Hardware Manual* of the drive.

Instructions for mounting the control panel onto a cabinet door are available in *ACS-CP-U Control Panel IP54 Mounting Platform Kit Installation Guide* (3AUA0000049072 [English]).

### ■ Electrical installation

Use a CAT5 straight-through network cable with a maximum length of 3 meters. Suitable cables are available from ABB.

For the control panel connector location on the drive, see the *Hardware Manual* of the drive.

---



## Layout

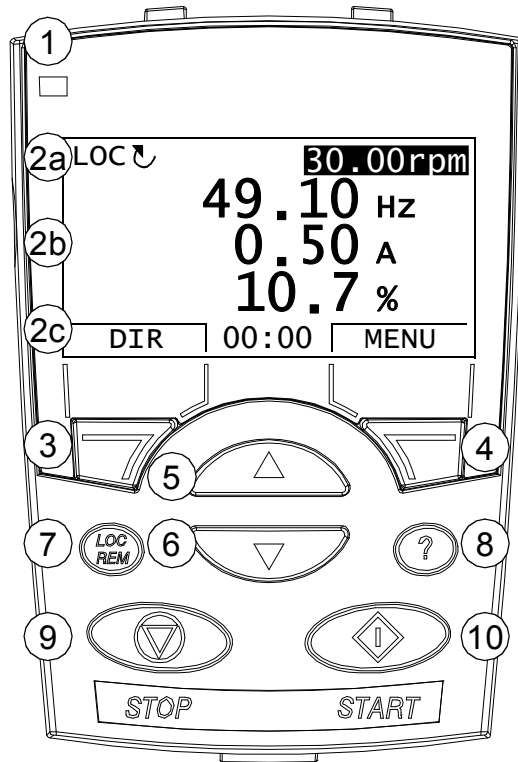

No.	Use
1	Status LED – Green = normal operation; blinking green = an alarm is active; red = a fault is active.
2	LCD display – Divided into three main areas: Status line – variable, depending on the mode of operation, see section <a href="#">Status line</a> on page 18. Center – variable; in general, shows signal and parameter values, menus or lists. Shows also faults and alarms. Bottom line – shows current functions of the two soft keys and, if enabled, the clock display.
3	Soft key 1 – Function depends on the context. The text in the lower left corner of the LCD display indicates the function.
4	Soft key 2 – Function depends on the context. The text in the lower right corner of the LCD display indicates the function.
5	Up – Scrolls up through a menu or list displayed in the center of the LCD display. Increments a value if a parameter is selected. Increments the reference value if the upper right corner is highlighted. Holding the key down changes the value faster.
6	Down – Scrolls down through a menu or list displayed in the center of the LCD display. Decrements a value if a parameter is selected. Decrements the reference value if the upper right corner is highlighted. Holding the key down changes the value faster.
7	LOC/REM – Changes between local and remote control of the drive.
8	Help – Displays context sensitive information when the key is pressed. The information displayed describes the item currently highlighted in the center of the display.
9	STOP – Stops the drive in local control.
10	START – Starts the drive in local control.

## ■ Status line

The top line of the LCD display shows the basic status information of the drive.

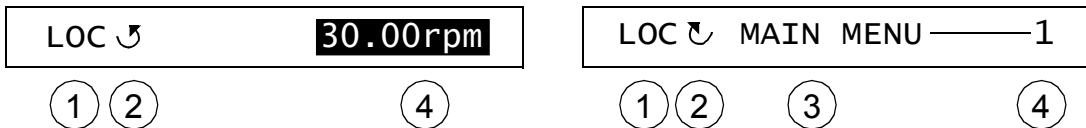



No.	Field	Alternatives	Significance
1	Control location	LOC	Drive control is local, that is, from the control panel.
		REM	Drive control is remote, such as the drive I/O or fieldbus.
2	State	↻	Forward shaft direction
		↺	Reverse shaft direction
		Rotating arrow	Drive is running at reference.
		Dotted rotating arrow	Drive is running but not at reference.
		Stationary arrow	Drive is stopped.
		Dotted stationary arrow	Start command is present, but the motor is not running, e.g. because start enable signal is missing.
3	Panel operation mode		<ul style="list-style-type: none"> <li>• Name of the current mode</li> <li>• Name of the list or menu shown</li> <li>• Name of the operation state, e.g. REF EDIT.</li> </ul>
4	Reference value or number of the selected item		<ul style="list-style-type: none"> <li>• Reference value in the Output mode</li> <li>• Number of the highlighted item, e.g mode, parameter group or fault.</li> </ul>

## Operating instructions

### ■ Basics of operation

You operate the control panel with menus and keys. The keys include two context-sensitive soft keys, whose current function is indicated by the text shown in the display above each key.

You select an option, e.g. operation mode or parameter, by entering the MENU state using soft key 2, and then by scrolling the  and  arrow keys until the option is highlighted and then pressing the relevant soft key. With the right soft key you usually enter a mode, accept an option or save the changes. The left soft key is used to cancel the made changes and return to the previous operation level.

The Control Panel has ten options in the Main menu: Parameters, Assistants, Changed Par, Fault Logger, Time & Date, Parameter Backup, I/O Settings, Reference Edit, Drive Info and Parameter Change Log. In addition, the control panel has an Output mode, which is used as default. Also, when a fault or alarm occurs, the panel goes automatically to the Fault mode showing the fault or alarm. You can reset the fault in the Output or Fault mode. The operation in these modes and options is described in this chapter.

Initially, the panel is in the Output mode, where you can start, stop, change the direction, switch between local and remote control, modify the reference value and monitor up to three actual values. To do other tasks, go first to the Main menu and select the appropriate option on the menu. The status line (see section [Status line](#) on page 18) shows the name of the current menu, mode, item or state.

LOC ↵	30.00rpm
49.10	Hz
0.50	A
10.7	%
DIR	00:00 MENU

LOC ↵	MAIN MENU	1
<b>PARAMETERS</b>		
<b>ASSISTANTS</b>		
<b>CHANGED PAR</b>		
EXIT	00:00	ENTER

## ■ List of tasks





The table below lists common tasks, the mode in which you can perform them, abbreviations of the options in the Main menu and the page number where the steps to do the task are described in detail.

Task	Mode / Main menu option	Abbreviations of the Main menu options *	Page
How to get help	Any	-	<a href="#">21</a>
How to find out the panel version	Any	-	<a href="#">21</a>
How to start and stop the drive	Output	-	<a href="#">22</a>
How to switch between local and remote control	Any	-	<a href="#">22</a>
How to change the direction of the motor rotation	Any	-	<a href="#">23</a>
How to set the speed or frequency reference in the Output mode	Output	-	<a href="#">23</a>
How to adjust the display contrast	Output	-	<a href="#">24</a>
How to change the value of a parameter	Parameters	PARAMETERS	<a href="#">25</a>
How to change the value of value pointer parameters	Parameters	PARAMETERS	<a href="#">26</a>
How to change the value of bit pointer parameters	Parameters	PARAMETERS	<a href="#">28</a>
How to change the value of bit pointer parameter to fixed 0 (FALSE) or 1 (TRUE)	Parameters	PARAMETERS	<a href="#">30</a>
How to select the monitored signals	Parameters	PARAMETERS	<a href="#">31</a>
How to do guided tasks (specification of related parameter sets) with assistants	Assistants	ASSISTANTS	<a href="#">32</a>
How to view and edit changed parameters	Changed Parameters	CHANGED PAR	<a href="#">33</a>
How to view faults	Fault Logger	FAULT LOGGER	<a href="#">35</a>
How to reset faults and alarms	Fault Logger	FAULT LOGGER	<a href="#">36</a>
How to show/hide the clock, change date and time formats, set the clock and enable/disable automatic clock transitions according to the daylight saving changes	Time & Date	TIME & DATE	<a href="#">37</a>
How to copy parameters from the drive to the control panel	Parameter Backup	PAR BACKUP	<a href="#">39</a>
How to restore parameters from the control panel to the drive	Parameter Backup	PAR BACKUP	<a href="#">39</a>
How to view backup information	Parameter Backup	PAR BACKUP	<a href="#">45</a>
How to edit and change parameter settings related to I/O terminals	I/O Settings	I/O SETTINGS	<a href="#">47</a>
How to edit reference value	Reference Edit	REF EDIT	<a href="#">49</a>
How to view drive info	Drive Info	DRIVE INFO	<a href="#">50</a>
How to view and edit recently changed parameters	Parameter Change Log	PAR CHG LOG	<a href="#">51</a>



\* Main menu options actually shown in the control panel.

## ■ Help and panel version – Any mode

### How to get help

Step	Action	Display
1.	<p>Press  to read the context-sensitive help text for the item that is highlighted.</p> <p>If help text exists for the item, it is shown on the display.</p>	<pre>LOC ↵ TIME &amp; DATE — 6 TIME FORMAT DATE FORMAT SET TIME SET DATE DAYLIGHT SAVING EXIT   00:00   SEL</pre> <pre>LOC ↵ HELP Use daylight saving to enable or disable automatic clock adjustment according to daylight saving EXIT   00:00  </pre>
2.	<p>If the whole text is not visible, scroll the lines with keys  and .</p>	<pre>LOC ↵ HELP to enable or disable automatic clock adjustment according to daylight saving changes EXIT   00:00  </pre>
3.	<p>After reading the text, return to the previous display by pressing .</p>	<pre>LOC ↵ TIME &amp; DATE — 6 TIME FORMAT DATE FORMAT SET TIME SET DATE DAYLIGHT SAVING EXIT   00:00   SEL</pre>









### How to find out the panel version

Step	Action	Display
1.	<p>If the power is switched on, switch it off.</p> <ul style="list-style-type: none"> <li>- If the panel cable can be disconnected easily, unplug the panel cable from the control panel, OR</li> <li>- if the panel cable can not be disconnected easily, switch off the control board or the drive.</li> </ul>	
2.	<p>Keep key  depressed while you switch on the power and read the information. The display shows the following panel information:</p> <p>Panel SW: Panel firmware version  ROM CRC: Panel ROM check sum  Flash Rev: Flash content version  Flash content comment.</p> <p>When you release the  key, the panel goes to the Output mode.</p>	<pre>PANEL VERSION INFO Panel SW:          x.xx Rom CRC:   xxxxxxxxxx Flash Rev:        x.xx XXXXXXXXXXXXXXXXXXXX XXXXXXXXXXXXXXXXXXXX</pre>

■ Basic operations – Any mode

**How to start, stop and switch between local and remote control**

You can start, stop and switch between local and remote control in any mode. To be able to start or stop the drive by using the control panel, the drive must be in local control.

Step	Action	Display
1.	<p>To switch between remote control (REM shown on the status line) and local control (LOC shown on the status line), press .</p> <p><b>Note:</b> Switching to local control can be prevented with parameter <a href="#">16.01 Local lock</a>.</p> <p>The very first time the drive is powered up, it is in remote control (REM) and controlled through the drive I/O terminals. To switch to local control (LOC) and control the drive using the control panel, press . The result depends on how long you press the key:                      If you release the key immediately (the display flashes “Switching to the local control mode”), the drive stops. Set the local control reference as instructed on page <a href="#">23</a>.                      If you press the key until the text “Keep running” appears, the drive continues running as before. The drive copies the current remote values for the run/stop status and the reference, and uses them as the initial local control settings.</p> <p>To stop the drive in local control, press .</p> <p>To start the drive in local control, press .</p>	<div data-bbox="921 544 1367 763" style="border: 1px solid black; padding: 5px;"> <p>LOC  MESSAGE                      Switching to the local control mode.</p> <hr/> <p style="text-align: center;">00:00</p> </div> <p>The arrow ( or ) on the status line stops rotating.</p> <p>The arrow ( or ) on the status line starts rotating. It is dotted until the drive reaches the setpoint.</p>

## ■ Output mode

In the Output mode, you can:



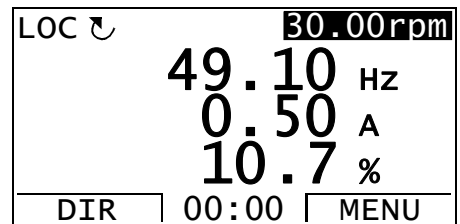

- monitor actual values of up to three signals
- change the direction of the motor rotation
- set the speed or frequency reference
- adjust the display contrast
- start, stop, change the direction and switch between local and remote control.

You get to the Output mode by pressing  repeatedly.

The top right corner of the display shows the reference value. The center can be configured to show up to three signal values or bar graphs; see page 31 for instructions on selecting and modifying the monitored signals.

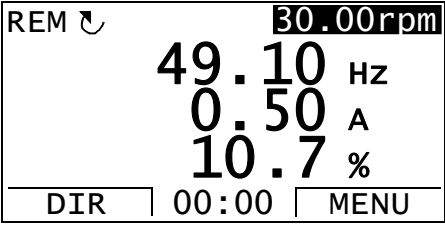

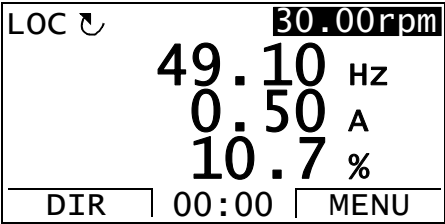
### How to change the direction of the motor rotation



Step	Action	Display
1.	If you are not in the Output mode, press  repeatedly until you get there.	
2.	If the drive is in remote control (REM shown on the status line), switch to local control by pressing  . The display briefly shows a message about changing the mode and then returns to the Output mode.	
3.	To change the direction from forward (↶ shown on the status line) to reverse (↷ shown on the status line), or vice versa, press  .	

### How to set the speed or frequency reference in the Output mode

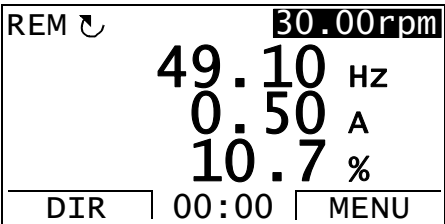

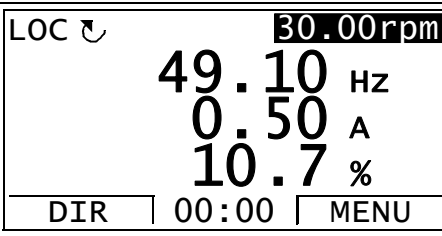

See also section [Reference Edit](#) on page 49.

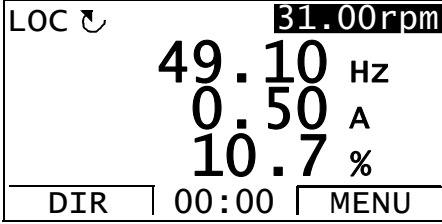
Step	Action	Display
1.	If you are not in the Output mode, press  repeatedly until you get there.	

## 24 The ACQ810 control panel

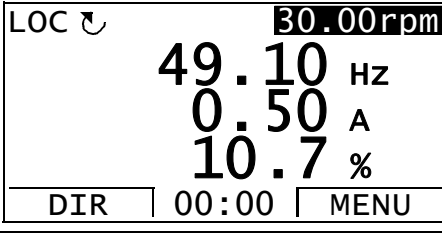
Step	Action	Display
2.	If the drive is in remote control (REM shown on the status line), switch to local control by pressing  . The display briefly shows a message about changing the mode and then returns to the Output mode.	
3.	To increase the highlighted reference value shown in the top right corner of the display, press  . The value changes immediately. It is stored in the permanent memory of the drive and restored automatically after power switch-off. To decrease the value, press  .	

### How to adjust the display contrast

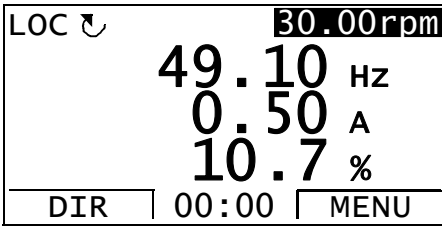
Step	Action	Display
1.	If you are not in the Output mode, press  repeatedly until you get there.	
2.	To increase the contrast, press keys  and  simultaneously. To decrease the contrast, press keys  and  simultaneously.	

















## ■ Parameters

In the Parameters option, you can:

- view and change parameter values
- start, stop, change the direction and switch between local and remote control.







### How to select a parameter and change its value













Step	Action	Display
1.	Go to the Main menu by pressing  if you are in the Output mode. Otherwise press  repeatedly until you get to the Main menu.	<pre> LOC ↵ MAIN MENU — 1 PARAMETERS ASSISTANTS CHANGED PAR EXIT   00:00   ENTER                     </pre>
2.	Go to the Parameters option by selecting PARAMETERS on the menu with keys  and  , and pressing  .	<pre> LOC ↵ PAR GROUPS — 01 01 Actual values 02 I/O values 03 Control values 04 Appl values 05 Pump values EXIT   00:00   SEL                     </pre>
3.	Select the appropriate parameter group with keys  and  .	<pre> LOC ↵ PAR GROUPS — 99 99 Start-up data 01 Actual values 02 I/O values 03 Control values 04 Appl values EXIT   00:00   SEL                     </pre>
	Press  .	<pre> LOC ↵ PARAMETERS — 9901 Language English 9904 Motor type 9905 Motor ctrl mode 9906 Mot nom current EXIT   00:00   EDIT                     </pre>
4.	Select the appropriate parameter with keys  and  . The current value of the parameter is shown below the selected parameter. Here the parameter 99.06 <i>Mot nom current</i> is used as an example.	<pre> LOC ↵ PARAMETERS — 9901 Language 9904 Motor type 9905 Motor ctrl mode 9906 Mot nom current 0.0 A EXIT   00:00   EDIT                     </pre>
	Press  .	<pre> LOC ↵ PAR EDIT — 9906 Mot nom current 0.0 A CANCEL   00:00   SAVE                     </pre>

Step	Action	Display
5.	Specify a new value for the parameter with keys  and  . Pressing an arrow key once increments or decrements the value. Keeping the key depressed for a while first quickly changes the current digit until the cursor moves left one position. This is repeated until the key is released. After the key is released, step-by-step adjustment of the current digit is possible. If neither key is pressed for a while, the cursor returns to the right one position at a time. Pressing both keys simultaneously replaces the displayed value with the default value.	<pre> LOC ↻ PAR EDIT 9906 Mot nom current                 3.5 A ----- CANCEL   00:00   SAVE                     </pre>
6.	To save the new value, press  . To cancel the new value and keep the original, press  .	<pre> LOC ↻ PARAMETERS 9906 Mot nom current                 3.5 A 9907 Mot nom voltage 9908 Mot nom freq 9909 Mot nom speed ----- EXIT   00:00   EDIT                     </pre>

### How to change the value of value pointer parameters











In addition to the parameters shown above, there are two kinds of pointer parameters; value pointer parameters and bit pointer parameters. A value pointer parameter points to the value of another parameter.









Step	Action	Display
1.	Go to the Main menu by pressing  if you are in the Output mode. Otherwise press  repeatedly until you get to the Main menu.	<pre> LOC ↻ MAIN MENU ——— 1 PARAMETERS ASSISTANTS CHANGED PAR ----- EXIT   00:00   ENTER                     </pre>
2.	Go to the Parameters option by selecting PARAMETERS on the menu with keys  and  , and pressing  .	<pre> LOC ↻ PAR GROUPS ——— 01 01 Actual values 02 I/O values 03 Control values 04 Appl values 05 Pump values ----- EXIT   00:00   SEL                     </pre>
3.	Select the appropriate parameter group with keys  and  . Here the value pointer parameter <a href="#">21.01 Speed ref1 sel</a> is used as an example.	<pre> LOC ↻ PAR GROUPS ——— 21 15 Analogue outputs 16 System 19 Speed calculation 20 Limits 21 Speed ref ----- EXIT   00:00   SEL                     </pre>

Step	Action	Display
4.	Press  to select the appropriate parameter group. Select the appropriate parameter with keys  and  , current value of each parameter is shown below it.	<pre> LOC ↵ PARAMETERS 2101 Speed ref1 sel       AI1 scaled 2102 Speed ref2 sel 2103 Speed ref1 func 2104 Speed ref1/2 sel EXIT   00:00   EDIT                     </pre>
5.	Press  . Current value of the value pointer parameter is shown, as well as the parameter it points to.	<pre> LOC ↵ PAR EDIT 2101 Speed ref1 sel       AI1 scaled [P.02.05] CANCEL   00:00   SEL                     </pre>
6.	Specify a new value with keys  and  . The parameter the value pointer parameter points to changes respectively.	<pre> LOC ↵ PAR EDIT 2101 Speed ref1 sel       FBA ref1 [P.02.26] CANCEL   00:00   SEL                     </pre>
7.	<p>Press  to accept any of the preselected values and to return to the parameters list. The new value is shown in the parameters list.</p> <p>To freely define an analog signal as the value, choose Pointer and press . The parameter group and index will be shown.</p> <p>Select the parameter group with  and . The text below the cursor displays the currently-selected parameter group.</p>	<pre> LOC ↵ PARAMETERS 2101 Speed ref1 sel       FBA ref1 2102 Speed ref2 sel 2105 Speed share 2109 SpeedRef min abs EXIT   00:00   EDIT                     </pre> <pre> LOC ↵ PAR EDIT 2101 Speed ref1 sel       P.02.05 02 I/O values CANCEL   00:00   SAVE                     </pre>
8.	Press  to select the parameter index. Again, the text below the cursor reflects the current setting.	<pre> LOC ↵ PAR EDIT 2101 Speed ref1 sel       P.02.07 0207 AI2 scaled CANCEL   00:00   SAVE                     </pre>
9.	To save the new value for the pointer parameter, press  . The new value is shown in the parameters list.	<pre> LOC ↵ PARAMETERS 2101 Speed ref1 sel       AI2 scaled 2102 Speed ref2 sel 2105 Speed share 2109 SpeedRef min abs EXIT   00:00   EDIT                     </pre>

### How to change the value of bit pointer parameters

The bit pointer parameter points to the value of a bit in another signal, or can be fixed to 0 (FALSE) or 1 (TRUE). For the latter option, see page 30. A bit pointer parameter points to a bit value (0 or 1) of one bit in a 32-bit signal. The first bit from the left is bit number 31, and the first bit from the right is bit number 0.













Step	Action	Display
1.	Go to the Main menu by pressing  if you are in the Output mode. Otherwise press  repeatedly until you get to the Main menu.	<pre> LOC ↻ MAIN MENU ——— 1 <b>PARAMETERS</b> <b>ASSISTANTS</b> <b>CHANGED PAR</b> EXIT   00:00   ENTER                     </pre>
2.	Go to the Parameters option by selecting PARAMETERS on the menu with keys  and  , and pressing  .	<pre> LOC ↻ PAR GROUPS ——— 01 <b>01 Actual values</b> 02 I/O values 03 Control values 04 Appl values 05 Pump values EXIT   00:00   SEL                     </pre>
3.	Select the appropriate parameter group with keys  and  . Here the bit pointer parameter <a href="#">10.02 Ext1 start in1</a> is used as an example.	<pre> LOC ↻ PAR GROUPS ——— 10 <b>10 Start/stop/dir</b> 11 Start/stop mode 12 Operating mode 13 Analogue inputs 14 Digital I/O EXIT   00:00   SEL                     </pre>
4.	Press  to select the appropriate parameter group. Current value of each parameter is shown below its name.  Select the parameter <a href="#">10.02 Ext1 start in1</a> with keys  and  .	<pre> LOC ↻ PARAMETERS ——— <b>1001 Ext1 start func</b> <b>In1</b> 1002 Ext1 start in1 1003 Ext1 start in2 1004 Ext2 start func EXIT   00:00   EDIT                     </pre> <pre> LOC ↻ PARAMETERS ——— 1001 Ext1 start func <b>1002 Ext1 start in1</b> <b>DI1</b> 1003 Ext1 start in2 1004 Ext2 start func EXIT   00:00   EDIT                     </pre>
5.	Press  .	<pre> LOC ↻ PAR EDIT ——— 1002 Ext1 start in1 <b>DI1</b> [P.02.01.00] CANCEL   00:00   SEL                     </pre>





Step	Action	Display
6.	Specify a new value with keys  and  . The text below the cursor shows the corresponding parameter group, index and bit.	<pre> LOC ↵ PAR EDIT 1002 Ext1 start in1       <b>DIO4</b> [P.02.03.03] CANCEL   00:00   SEL                     </pre>
7.	<p>Press  to accept any of the preselected values and to return to the parameters list.</p> <p>To freely define a bit of a binary parameter as the value, choose Pointer and press . The parameter group, index and bit will be shown.</p> <p>Select the parameter group with  and . The text below the cursor displays the currently-selected parameter group.</p>	<pre> LOC ↵ PARAMETERS 1002 Ext1 start in1       <b>DIO4</b> 1003 Ext1 start in2 1004 Ext2 start func 1005 Ext2 start in1 EXIT   00:00   EDIT                     </pre> <pre> LOC ↵ PAR EDIT 1002 Ext1 start in1       <b>P.02.01.00</b> 02 I/O values CANCEL   00:00   SAVE                     </pre>
8.	Press  to select the parameter index. Again, the text below the cursor reflects the current setting.	<pre> LOC ↵ PAR EDIT 1002 Ext1 start in1       <b>P.02.01.00</b> 0201 DI status CANCEL   00:00   SAVE                     </pre>
9.	Press  to select the bit. Again, the text below the cursor reflects the current setting.	<pre> LOC ↵ PAR EDIT 1002 Ext1 start in1       <b>P.02.01.01</b> 01 DI2 CANCEL   00:00   SAVE                     </pre>
10.	To save the new value for the pointer parameter, press  . The new value is shown in the parameters list.	<pre> LOC ↵ PARAMETERS 1002 Ext1 start in1       <b>P.02.01.01</b> 1003 Ext1 start in2 1004 Ext2 start func 1005 Ext2 start in1 EXIT   00:00   EDIT                     </pre>

### How to change the value of bit pointer parameter to fixed 0 (FALSE) or 1 (TRUE)

The bit pointer parameter can be fixed to constant value of 0 (FALSE) or 1 (TRUE).

When adjusting a bit pointer parameter on the control panel, CONST is selected in order to fix the value to 0 (displayed as C.FALSE) or 1 (C.TRUE).

Step	Action	Display
1.	Go to the Main menu by pressing  if you are in the Output mode. Otherwise press  repeatedly until you get to the Main menu.	<pre> LOC ↺ MAIN MENU — 1 PARAMETERS ASSISTANTS CHANGED PAR EXIT   00:00   ENTER                     </pre>
2.	Go to the Parameters option by selecting PARAMETERS on the menu with keys  and  , and pressing  .  Select the appropriate parameter group with keys  and  . Here the bit pointer parameter 14.07 DIO2 out src is used as an example.	<pre> LOC ↺ PAR GROUPS — 01 01 Actual values 02 I/O values 03 Control values 04 Appl values 05 Pump values EXIT   00:00   SEL  LOC ↺ PAR GROUPS — 14 10 Start/stop/dir 11 Start/stop mode 12 Operating mode 13 Analogue inputs 14 Digital I/O EXIT   00:00   SEL                     </pre>
3.	Press  to select the appropriate parameter group. Select the appropriate parameter with keys  and  . Current value of each parameter is shown below its name.	<pre> LOC ↺ PARAMETERS — 1404 DIO1 Ton 1405 DIO1 Toff 1406 DIO2 conf 1407 DIO2 out src       P.06.02.03 EXIT   00:00   EDIT                     </pre>
4.	Press  .  Select CONST with keys  and  .	<pre> LOC ↺ PAR EDIT — 1407 DIO2 out src       Pointer CANCEL   00:00   NEXT  LOC ↺ PAR EDIT — 1407 DIO2 out src       Const CANCEL   00:00   NEXT                     </pre>

Step	Action	Display
5.	Press  .	<pre> LOC ↻ PAR EDIT 1407 DIO2 out src       C.FALSE [0] CANCEL   00:00   SAVE                     </pre>
6.	Specify a new constant value (TRUE or FALSE) for the bit pointer parameter with keys  and  .	<pre> LOC ↻ PAR EDIT 1407 DIO2 out src       C.TRUE [1] CANCEL   00:00   SAVE                     </pre>
7.	To continue, press  . To cancel the new value and keep the original, press  . The new value is shown in the parameters list.	<pre> LOC ↻ PARAMETERS 1407 DIO2 out src       C.TRUE 1408 DIO2 Ton 1409 DIO2 Toff 1410 DIO3 conf EXIT   00:00   EDIT                     </pre>

### How to select the monitored signals

Step	Action	Display
1.	<p>You can select which signals are monitored in the Output mode and how they are displayed with group <a href="#">56 Panel display</a> parameters. See page <a href="#">25</a> for detailed instructions on changing parameter values.</p> <p><b>Note:</b> If you set one of the parameters <a href="#">56.01</a>...<a href="#">56.03</a> to zero, in the output mode you can see names for the two remaining signals. The names are also shown if you set one of the mode parameters <a href="#">56.04</a>...<a href="#">56.06</a> to <i>Disabled</i>.</p>	<pre> LOC ↻ PAR EDIT 5601 signal1 param       01.03 CANCEL   00:00   NEXT                     </pre> <pre> LOC ↻ PAR EDIT 5602 signal2 param       01.04 CANCEL   00:00   NEXT                     </pre> <pre> LOC ↻ PAR EDIT 5603 signal3 param       01.06 CANCEL   00:00   NEXT                     </pre>

## ■ Assistants

Assistants are routines that guide you through the essential parameter settings related to a specific task, for example application macro selection, entering the motor data, or reference selection.

An assistant may merely consist of a sequence of parameters that the user must adjust, but may also involve questions; based on the answers, one or several parameters are automatically adjusted. The assistant may also display additional information about the selections.













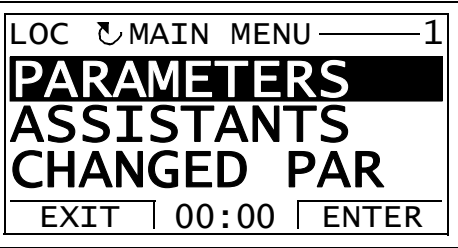

In the Assistants mode, you can:

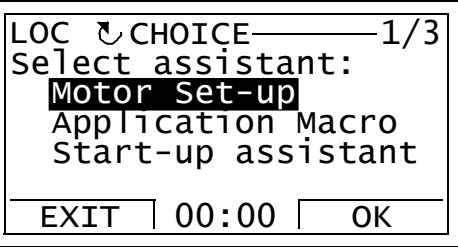
- use assistants to guide you through the specification of a set of basic parameters
- start, stop, change the direction and switch between local and remote control.

Different firmware versions may include different assistants.

### How to invoke an assistant

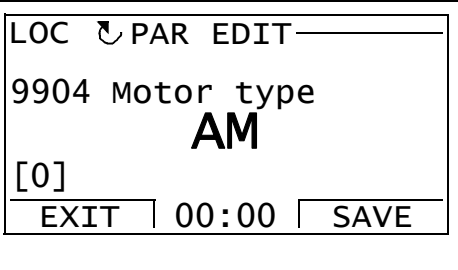
The table below shows how assistants are invoked.

Step	Action	Display
1.	Go to the Main menu by pressing  if you are in the Output mode. Otherwise press  repeatedly until you get to the Main menu.	
2.	Go to the Assistants mode by selecting ASSISTANTS on the menu with keys  and  , and pressing  .	
3.	Select an assistant by highlighting it with  and  , and by pressing  . <ul style="list-style-type: none"> <li>• Whenever the assistant prompts the user to adjust a parameter, the adjustment is made as described starting on page 25.</li> <li>• Whenever the assistant prompts a question, select the most suitable answer with  and , and press .</li> </ul>	
4.	After the assistant has been completed, the main menu is displayed. To run another assistant, repeat the procedure from step 2. To abort the assistant at any point, press  .	













## ■ Changed Parameters



In the Changed Parameters mode, you can:

- view a list of all parameters that have been changed from the macro default values
- change these parameters
- start, stop, change the direction and switch between local and remote control.

### How to view and edit changed parameters

Step	Action	Display
1.	Go to the Main menu by pressing  if you are in the Output mode. Otherwise press  repeatedly until you get to the Main menu.	<pre> LOC ↻ MAIN MENU ——— 1 <b>PARAMETERS</b> <b>ASSISTANTS</b> <b>CHANGED PAR</b> EXIT   00:00   ENTER                     </pre>
2.	Go to the Changed Parameters mode by selecting CHANGED PAR on the menu with keys  and  , and pressing  . If there are no changed parameters in the history, corresponding text will be shown.  If parameters have been changed, a list of them is shown. Select the changed parameter on the list with keys  and  . The value of the selected parameter is shown below it.	<pre> LOC ↻ MESSAGE ——— No parameters    00:00    LOC ↻ CHANGED PAR ——— <b>9906 Mot nom current</b> <b>3.5 A</b> 9907 Mot nom voltage 9908 Mot nom freq 9909 Mot nom speed EXIT   00:00   EDIT                     </pre>
3.	Press  to modify the value.	<pre> LOC ↻ PAR EDIT ——— 9906 Mot nom current <b>3.5 A</b> CANCEL   00:00   SAVE                     </pre>
4.	Specify a new value for the parameter with keys  and  . Pressing the key once increments or decrements the value. Holding the key down changes the value faster. Pressing the keys simultaneously replaces the displayed value with the default value.	<pre> LOC ↻ PAR EDIT ——— 9906 Mot nom current <b>3.0 A</b> CANCEL   00:00   SAVE                     </pre>

### 34 The ACQ810 control panel















Step	Action	Display
5.	<p>To accept the new value, press . If the new value is the default value, the parameter is removed from the list of changed parameters.</p> <p>To cancel the new value and keep the original, press .</p>	<pre> LOC  ↶ CHANGED PAR 9906 Mot nom current       3.0 A 9907 Mot nom voltage 9908 Mot nom freq 9909 Mot nom speed ----- EXIT   00:00   EDIT           </pre>

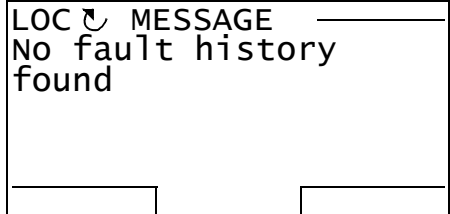
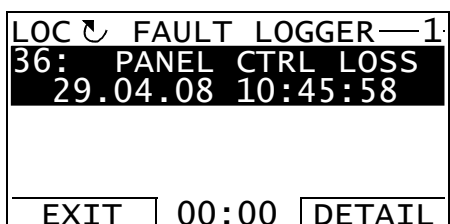



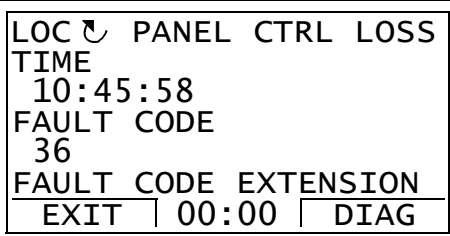

## ■ Fault Logger

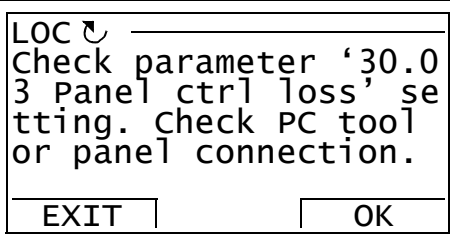
In the Fault Logger option, you can:



- view the drive fault history
- see the details of the most recent faults
- read the help text for the fault and make corrective actions
- start, stop, change the direction and switch between local and remote control.

### How to view faults

Step	Action	Display
1.	Go to the Main menu by pressing  if you are in the Output mode. Otherwise press  repeatedly until you get to the Main menu.	
2.	Go to the Fault Logger option by selecting FAULT LOGGER on the menu with keys  and  , and pressing  . If there are no faults in the fault history, corresponding text will be shown.  If there is a fault history, the display shows the fault log starting with the most recent fault. The number on the row is the fault code according to which the causes and corrective actions are listed in chapter <a href="#">Fault tracing</a> (page 335).	 
3.	To see the details of a fault, select it with keys  and  , and press  . Scroll the text with keys  and  . To return to the previous display, press  .	
4.	If you want help in diagnosing the fault, press  .	

Step	Action	Display
5.	Press  . The panel allows you to edit necessary parameters to correct the fault.	<div style="border: 1px solid black; padding: 5px;">                     LOC  PAR EDIT                      3003 Panel ctrl loss  <b>Fault</b>                      [1]                      EXIT   00:00   SAVE                 </div>
6.	Specify a new value for the parameter with keys  and  . To accept the new value, press  . To cancel the new value and keep the original, press  .	<div style="border: 1px solid black; padding: 5px;">                     LOC  PAR EDIT                      3003 Panel ctrl loss  <b>Spd ref Safe</b>                      [2]                      EXIT   00:00   SAVE                 </div>

### How to reset faults

Step	Action	Display
1.	When a fault occurs, a text identifying the fault is shown. To reset the fault, press  . To return to the previous display, press  .	<div style="border: 1px solid black; padding: 5px;">                     LOC  FAULT                      FAULT 36                      PANEL CTRL LOSS                      RESET   EXIT                 </div>

















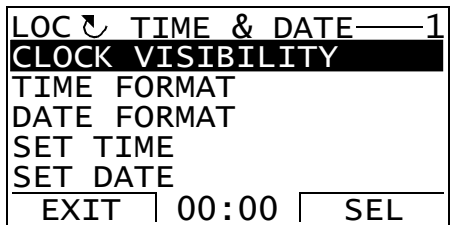

## ■ Time & Date



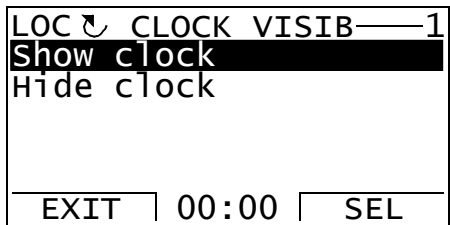





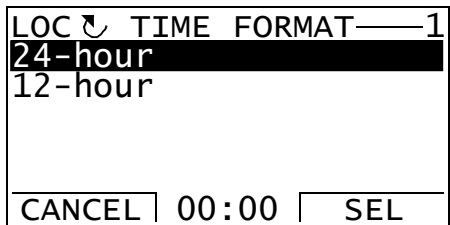



















In the Time & Date option, you can:

- show or hide the clock
- change date and time display formats
- set the date and time
- enable or disable automatic clock transitions according to the daylight saving changes
- start, stop, change the direction and switch between local and remote control.

The Control Panel contains a battery to ensure the function of the clock when the panel is not powered by the drive.

### How to show or hide the clock, change display formats, set the date and time and enable or disable clock transitions due to daylight saving changes

Step	Action	Display
1.	Go to the Main menu by pressing  if you are in the Output mode. Otherwise press  repeatedly until you get to the Main menu.	
2.	Go to the Time & Date option by selecting TIME & DATE on the menu with keys  and  , and pressing  .	
3.	To show (hide) the clock, select CLOCK VISIBILITY on the menu, press  , select Show clock (Hide clock) with keys  and  and press  , or, if you want to return to the previous display without making changes, press  .	
	To specify the time format, select TIME FORMAT on the menu, press  and select a suitable format with keys  and  . Press  to save or  to cancel your changes.	

Step	Action	Display
	<p>To specify the date format, select DATE FORMAT on the menu, press  and select a suitable format. Press  to save or  to cancel your changes.</p> <p>To set the time, select SET TIME on the menu and press . Specify the hours with keys  and , and press . Then specify the minutes. Press  to save or  to cancel your changes.</p>	<p>LOC  DATE FORMAT—1            dd.mm.yy            mm/dd/yy  <b>dd.mm.yyyy</b>            mm/dd/yyyy</p> <p>CANCEL   00:00   OK</p> <hr/> <p>LOC  SET TIME—    <b>15:41</b></p> <p>CANCEL     OK</p>
	<p>To set the date, select SET DATE on the menu and press . Specify the first part of the date (day or month depending on the selected date format) with keys  and , and press . Repeat for the second part. After specifying the year, press . To cancel your changes, press .</p>	<p>LOC  SET DATE—    <b>19.03.2008</b></p> <p>CANCEL   00:00   OK</p>
	<p>To enable or disable the automatic clock transitions according to the daylight saving changes, select DAYLIGHT SAVING on the menu and press . Pressing  opens the help that shows the beginning and end dates of the period during which daylight saving time is used in each country or area whose daylight saving changes you can select to be followed. Scroll the text with keys  and . To return to the previous display, press .</p> <p>To disable automatic clock transitions according to the daylight saving changes, select Off and press .</p> <p>To enable automatic clock transitions, select the country or area whose daylight saving changes are followed and press .</p> <p>To return to the previous display without making changes, press .</p>	<p>LOC  DAYLIGHT SAV—1  <b>off</b>            EU            US            Australia1:NSW,Vict..            Australia2:Tasmania..</p> <p>EXIT   00:00   SEL</p> <hr/> <p>LOC  HELP—            EU:            On: Mar last Sunday            Off: Oct last Sunday</p> <p>US:            EXIT   00:00  </p>

## ■ Parameter Backup

The Parameter Backup option is used to export parameters from one drive to another or to make a backup of the drive parameters. Uploading stores all drive parameters, including up to four user sets, to the Control Panel. Selectable subsets of the backup file can then be restored/downloaded from the control panel to the same drive or another drive of the same type.

In the Parameter Backup option, you can:



- Copy all parameters from the drive to the control panel with MAKE BACKUP TO PANEL. This includes all defined user sets of parameters and internal (not adjustable by the user) parameters such as those created by the ID Run.
- View the information about the backup stored in the control panel with SHOW BACKUP INFO. This includes e.g. version information etc. of the current backup file in the panel. It is useful to check this information when you are going to restore the parameters to another drive with RESTORE PARS ALL to ensure that the drives are compatible.
- Restore the full parameter set from the control panel to the drive using the RESTORE PARS ALL command. This writes all parameters, including the internal non-user-adjustable motor parameters, to the drive. It does NOT include the user sets of parameters.









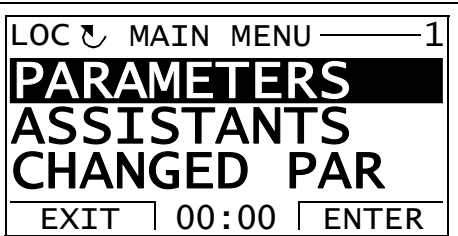





**Note:** Use this function only to restore the parameters from a backup or to restore parameters to systems that are compatible.

- Restore all parameters, except motor data, to the drive with RESTORE PARS NO-IDRUN.
- Restore only motor data parameters to the drive with RESTORE PARS IDRUN.
- Restore all user sets to the drive with RESTORE ALL USER SETS.
- Restore only user set 1...4 to the drive with RESTORE USER SET 1...RESTORE USER SET 4.

### How to backup and restore parameters

For all backup and restore functions available, see page [39](#).

Step	Action	Display
1.	Go to the Main menu by pressing  if you are in the Output mode. Otherwise press  repeatedly until you get to the Main menu.	



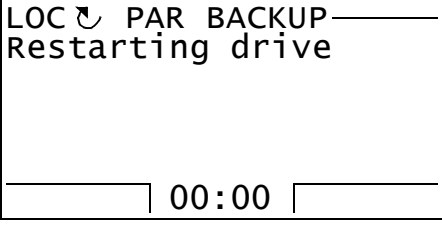
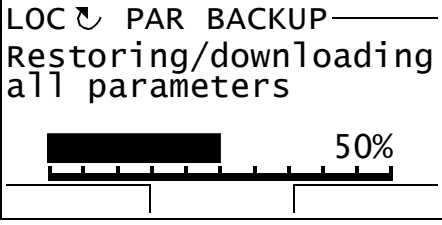
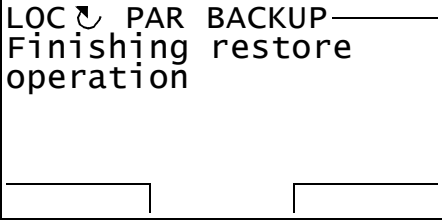

Step	Action	Display
2.	<p>Go to the Parameter Backup option by selecting PAR BACKUP on the menu with keys  and , and pressing .</p>	<pre> LOC ↶ PAR BACKUP——1 <b>MAKE BACKUP TO PANEL</b> SHOW BACKUP INFO RESTORE PARS ALL RESTORE PARS NO-IDRUN RESTORE PARS IDRUN EXIT   00:00   SEL                     </pre>
	<p>To copy all parameters (including user sets and internal parameters) from the drive to the control panel, select MAKE BACKUP TO PANEL on the Par Backup with keys  and , and press . Operation starts. Press  if you want to stop the operation.</p> <p>After the backup is completed, the display shows a message about the completion. Press  to return to the Par Backup.</p>	<pre> LOC ↶ PAR BACKUP—— Copying file 1/2  ABORT   00:00    LOC ↶ MESSAGE—— Parameter upload successful  OK   00:00                       </pre>
	<p>To perform restore functions, select the appropriate operation (here RESTORE PARS ALL is used as an example) on the Par Backup with keys  and .</p> <p>Press . Restoring starts.</p> <p>A version check is made. Scroll the text with keys  and .</p> <p>If you want to continue, press . Press  if you want to stop the operation. If the downloading is continued, the display shows a message about it.</p>	<pre> LOC ↶ PAR BACKUP——3 MAKE BACKUP TO PANEL SHOW BACKUP INFO <b>RESTORE PARS ALL</b> RESTORE PARS NO-IDRUN RESTORE PARS IDRUN EXIT   00:00   SEL  LOC ↶ PAR BACKUP—— Initializing param restore operation    00:00    LOC ↶ VERSION CHECK -1 <b>FIRMWARE VERSION</b>     UIFQ,200F,0,     UIFQ,200C,0,     OK PRODUCT VARIANT CANCEL   00:00   CONT  LOC ↶ PAR BACKUP—— Initializing param. restore operation    00:00                       </pre>





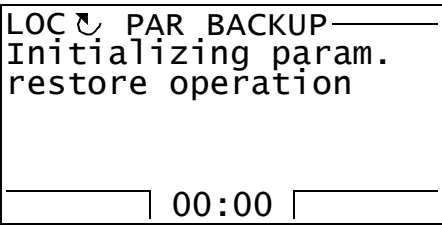

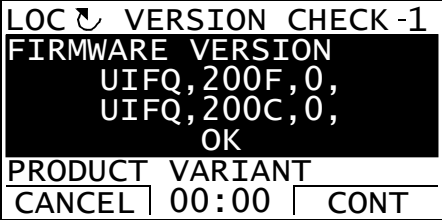
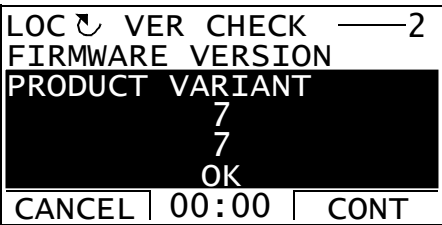

Step	Action	Display
	Downloading continues, drive is being restarted.	
	<p>The display shows the transfer status as a percentage of completion.</p> <p>Downloading finishes.</p>	 

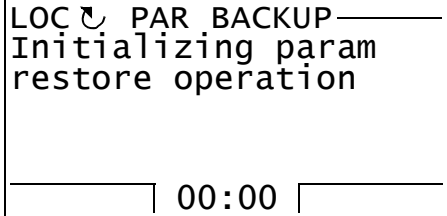
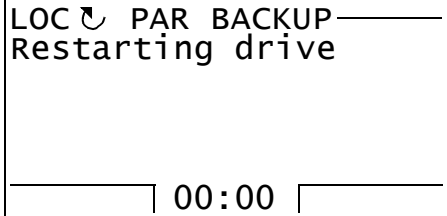
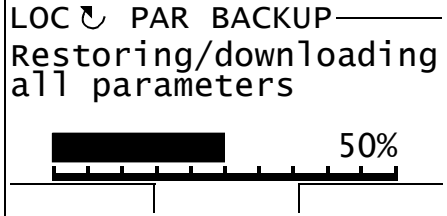
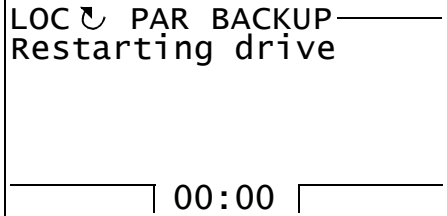
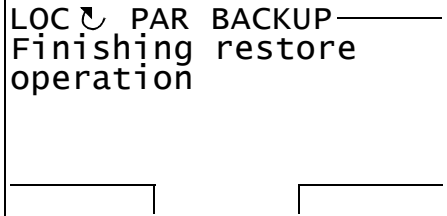
### Parameter errors

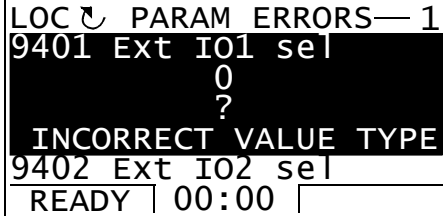
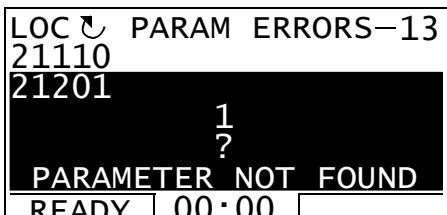
If you try to backup and restore parameters between different firmware versions, the panel shows you the following parameter error information:



Step	Action	Display
1.	Restore operation starts normally.	
2.	<p>A version check is made. You can see on the panel that the firmware versions are not the same.</p> <p>Scroll the text with keys  and . To continue, press . Press  to stop the operation.</p>	 

Step	Action	Display
3.	If the downloading is continued, the display shows a message about it.	
	Downloading continues, drive is being restarted.	
	The display shows the transfer status as a percentage of completion.	
	Downloading continues.	
	Downloading finishes.	
4.	<p>The panel shows a list of erroneous parameters.</p> <p>You can scroll the parameters with keys  and . The reason for parameter error is also shown.</p>	 

Step	Action	Display
5.	You can edit parameters by pressing  when EDIT command is visible. Parameter <i>95.01 Ctrl boardSupply</i> is used as an example.  Edit the parameter as shown in section <i>Parameters</i> on page 25.	<pre> LOC ↵ PAR EDIT 9501 ctrl boardSupply <b>External 24V</b> [1] CANCEL   00:00   SAVE                     </pre>
6.	Press  to save the new value.  Press  to return to the list of erroneous parameters.	<pre> LOC ↵ PAR EDIT 9501 ctrl boardSupply <b>Internal 24V</b> [0] CANCEL   00:00   SAVE                     </pre>
7.	The parameter value you chose is visible under the parameter name.  Press  when you have finished editing the parameters.	<pre> LOC ↵ PARAM ERRORS—9 9501 ctrl boardSupply 0 0 <b>INCORRECT VALUE TYPE</b> 9503 READY   00:00   EDIT                     </pre>

### Trying to restore a user set between different firmware versions

If you try to backup and restore a user set between different firmware versions, the panel shows you the following alarm information:









Step	Action	Display
1.	Restore operation starts normally.	<pre> LOC ↵ PAR BACKUP— Initializing param restore operation    00:00                       </pre>
2.	Version check is also OK. You can see on the panel that the firmware versions are not the same.  You can scroll the text with keys  and  .	<pre> LOC ↵ VER CHECK —1 FIRMWARE VERSION UIFQ,200F,0, UIFQ,200C,0, OK PRODUCT VARIANT CANCEL   00:00   CONT                     </pre> <pre> LOC ↵ VER CHECK —2 FIRMWARE VERSION PRODUCT VARIANT 7 7 OK CANCEL   00:00   CONT                     </pre>

44 The ACQ810 control panel



Step	Action	Display
3.	If the downloading is continued, the display shows a message about it.	<div style="border: 1px solid black; padding: 5px;"> <p>LOC ↻ PAR BACKUP</p> <p>Initializing param restore operation</p> <p style="text-align: right;">00:00</p> </div>
4.	Downloading continues, drive is being restarted.	<div style="border: 1px solid black; padding: 5px;"> <p>LOC ↻ PAR BACKUP</p> <p>Restarting drive</p> <p style="text-align: right;">00:00</p> </div>
5.	The display shows the transfer status as a percentage of completion.	<div style="border: 1px solid black; padding: 5px;"> <p>LOC ↻ PAR BACKUP</p> <p>Restoring/downloading user set 1</p> <div style="text-align: right; margin-top: 10px;">  <p>50%</p> </div> <p style="text-align: right;">00:00</p> </div>
6.	Downloading continues.	<div style="border: 1px solid black; padding: 5px;"> <p>LOC ↻ PAR BACKUP</p> <p>Initializing param restore operation</p> <p style="text-align: right;">00:00</p> </div>
7.	Downloading continues, drive is being restarted.	<div style="border: 1px solid black; padding: 5px;"> <p>LOC ↻ PAR BACKUP</p> <p>Restarting drive</p> <p style="text-align: right;">00:00</p> </div>
8.	Downloading finishes.	<div style="border: 1px solid black; padding: 5px;"> <p>LOC ↻ PAR BACKUP</p> <p>Finishing restore operation</p> <p style="text-align: right;">00:00</p> </div>
9.	Panel shows a text identifying the alarm and returns to the Par Backup.	<div style="border: 1px solid black; padding: 5px;"> <p>LOC ↻ ALARM</p> <p>ALARM 2036 RESTORE</p> <p style="text-align: right;">EXIT</p> </div>









### Trying to load a user set between different firmware versions

If you try load a user set between different firmware versions, the panel shows you the following fault information:

Step	Action	Display
1.	Go to the Parameters option by selecting PARAMETERS on the main menu as shown in section <a href="#">Parameters</a> on page 25. A user set is loaded through parameter <a href="#">16.09 User set sel</a> . Select parameter group <a href="#">16 System</a> with keys  and  .	<pre> LOC ↻ PAR GROUPS——16 12 Operating mode 13 Analogue inputs 14 Digital I/O 15 Analogue outputs 16 System EXIT   00:00   SEL                     </pre>
2.	Press  to select parameter group 16. Select parameter <a href="#">16.09 User set sel</a> with keys  and  . Current value of each parameter is shown below its name.	<pre> LOC ↻ PARAMETERS—— 1603 Pass code 1604 Param restore 1607 Param save 1609 User set sel       No request EXIT   00:00   EDIT                     </pre>
3.	Press  .  Select the user set you want to load with keys  and  .  Press  .	<pre> LOC ↻ PAR EDIT—— 1609 User set sel       No request [1] CANCEL   00:00   SAVE                     </pre> <pre> LOC ↻ PAR EDIT—— 1609 User set sel       Load set 1 [2] CANCEL   00:00   SAVE                     </pre>
4.	Panel shows a text identifying the fault.	<pre> LOC ↻ FAULT—— FAULT 310 USERSET LOAD RESET              EXIT                     </pre>

### How to view information about the backup

Step	Action	Display
1.	Go to the Main menu by pressing  if you are in the Output mode. Otherwise press  repeatedly until you get to the Main menu.	<pre> LOC ↻ MAIN MENU——1 PARAMETERS ASSISTANTS CHANGED PAR EXIT   00:00   ENTER                     </pre>















Step	Action	Display
2.	Go to the Par Backup option by selecting PAR BACKUP on the menu with keys  and  , and pressing  . Select SHOW BACKUP INFO with keys  and  .	<pre>                     LOC ↻ PAR BACKUP——2                     MAKE BACKUP TO PANEL                     SHOW BACKUP INFO                     RESTORE PARS ALL                     RESTORE PARS NO-IDRUN                     RESTORE PARS IDRUN                     EXIT   00:00   SEL                 </pre>
3.	Press  . The display shows the following information about the drive from where the backup was made: BACKUP INTERFACE VER: Format version of the backup file FIRMWARE VERSION: Information on the firmware UIFQ: Firmware of the ACQ810 drive 2010: Firmware version 0: Firmware patch version PRODUCT VARIANT: 7: ACQ810 (Pump control program) You can scroll the information with  and  .	<pre>                     LOC ↻ BACKUP INFO——                     BACKUP INTERFACE VER                     0.4                     0.4                     FIRMWARE VERSION                     UIFQ,2010,0,                     EXIT   00:00                   </pre> <pre>                     LOC ↻ BACKUP INFO——                     FIRMWARE VERSION                     UIFQ,2010,0,                     UIFQ,200F,0,                     PRODUCT VARIANT                     7                     EXIT   00:00                   </pre>
4.	Press  to return to the Par Backup.	<pre>                     LOC ↻ PAR BACKUP——1                     MAKE BACKUP TO PANEL                     SHOW BACKUP INFO                     RESTORE PARS ALL                     RESTORE PARS NO-IDRUN                     RESTORE PARS IDRUN                     EXIT   00:00   SEL                 </pre>







## I/O Settings

In the I/O Settings mode, you can:

- check the parameter settings that configure the I/Os of the drive
- check the parameters that have an input or output selected as their source or target
- edit the parameter setting
- start, stop, change the direction and switch between local and remote control.

### How to edit and change parameter settings related to I/O terminals

Step	Action	Display
1.	Go to the Main menu by pressing  if you are in the Output mode. Otherwise press  repeatedly until you get to the Main menu.	<pre> LOC ↻ MAIN MENU —1 PARAMETERS ASSISTANTS CHANGED PAR EXIT   00:00   ENTER                     </pre>
2.	Go the I/O Settings mode by selecting I/O SETTINGS on the menu with keys  and  , and pressing  .  Select the I/O group, e.g. Digital inputs, with keys  and  .	<pre> LOC ↻ I/O SETTINGS —1 Analog outputs Analog inputs Digital I/Os Digital inputs Relay outputs EXIT   00:00   SEL  LOC ↻ I/O SETTINGS —4 Analog outputs Analog inputs Digital I/Os Digital inputs Relay outputs EXIT   00:00   SEL                     </pre>
3.	Press  . After a brief pause, the display shows the current settings for the selection. You can scroll digital inputs and parameters with keys  and  .	<pre> LOC ↻ I/O SETTINGS —1 DI1 1002 Ext1 start in1 DI2 DI3 1010 Fault reset sel EXIT   00:00   INFO                     </pre>
4.	Press  . The panel shows information related to I/O selected (in this case, DI1). You can scroll information with keys  and  . Press  to return to the digital inputs.	<pre> LOC ↻ I/O INFO — NUM OF I/O ITEMS 0 SLOT NUMBER 0 NODE NUMBER EXIT   00:00                       </pre>

Step	Action	Display
5.	Select the setting (line with a parameter number) with keys  and  . You can edit the parameter (INFO selection turns into EDIT selection).	<pre> LOC  ↶ I/O SETTINGS—1 DI1 <b>1002 Ext1 start in1</b> DI2 DI3 1010 Fault reset sel EXIT   00:00   EDIT                     </pre>
6.	Press  .	<pre> LOC  ↶ PAR EDIT— 1002 Ext1 start in1 <b>DI1</b> [P.02.01.00] CANCEL   00:00   SEL                     </pre>
7.	Specify a new value for the setting with keys  and  . Pressing the key once increments or decrements the value. Holding the key down changes the value faster. Pressing the keys simultaneously replaces the displayed value with the default value.	<pre> LOC  ↶ PAR EDIT— 1002 Ext1 start in1 <b>DI04</b> [P.02.03.03] CANCEL   00:00   SEL                     </pre>
8.	To save the new value, press  . To cancel the new value and keep the original, press  .	<pre> LOC  ↶ I/O SETTINGS—1 DI1 <b>1002 Ext1 start in1</b> DI2 DI3 1010 Fault reset sel EXIT   00:00   EDIT                     </pre>

















## ■ Reference Edit

In the Reference Edit option, you can:

- accurately control the local reference value,
- start, stop, change the direction and switch between local and remote control.

### How to edit reference value









Step	Action	Display
1.	If the panel is in the remote control mode (REM shown on the status line), switch to local control (LOC shown on the status line) by pressing  . (See page 22 for more information on switching between the local and remote control modes.) <b>Note:</b> By default, reference editing from the panel is only possible in the local control mode. In the remote control mode, the reference can be edited from the control panel only if it (ie. parameter 02.34 Panel ref) has been specified as the source of the active external reference. The message shown on the right is displayed if the reference cannot be edited from the panel.	REM ↻ MESSAGE Reference editing enabled only in local control mode  00:00
2.	Otherwise, go to the Main menu by pressing  if you are in the Output mode. Otherwise press  repeatedly until you get to the Main menu.	LOC ↻ MAIN MENU — 1 <b>PARAMETERS</b> <b>ASSISTANTS</b> <b>CHANGED PAR</b> EXIT   00:00   ENTER
3.	Go to the Reference Edit option by selecting REF EDIT on the menu with keys  and  , and pressing  .	LOC ↻ REF EDIT  ■ 0000.00 rpm  CANCEL   00:00   NEXT
4.	Select the correct sign with keys  and  , and press  . Select the correct numbers with keys  and  , and after each number is selected, press  .	LOC ↻ REF EDIT  -1250.00 rpm  CANCEL   00:00   SAVE
5.	After the last number is selected, press  . Go to the Output mode by pressing  . The selected reference value is shown in the status line.	LOC ↻ <b>-1250.00 rpm</b> 49.10 Hz 0.50 A 10.7 % DIR   00:00   MENU

## ■ Drive Info

In the Drive Info option, you can:

- view information on the drive,
- start, stop, change the direction and switch between local and remote control.

### How to view drive info













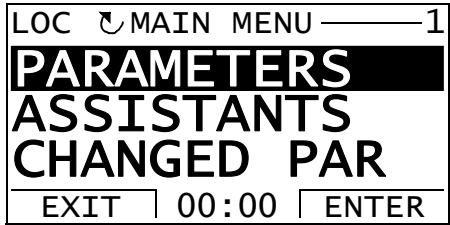

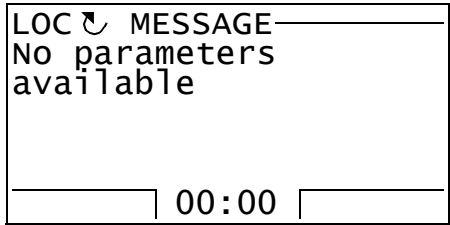
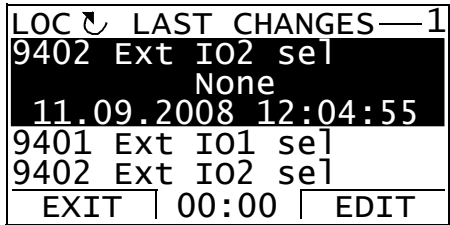

Step	Action	Display
1.	Go to the Main menu by pressing  if you are in the Output mode. Otherwise press  repeatedly until you get to the Main menu.	<pre> LOC ↺ MAIN MENU ——— 1 PARAMETERS ASSISTANTS CHANGED PAR EXIT   00:00   ENTER                     </pre>
2.	Go to the Drive info option by selecting DRIVE INFO on the menu with keys  and  , and pressing  .	<pre> LOC ↺ DRIVE INFO ——— DRIVE NAME - DRIVE TYPE ACQ810 DRIVE MODEL EXIT   00:00                       </pre>
3.	The display shows information about the drive. You can scroll the information with keys  and  . <b>Note:</b> The information shown may vary according to the firmware version of the drive. DRIVE NAME: Drive name defined as a text in DriveStudio commissioning and maintenance tool DRIVE TYPE: e.g. ACQ810 DRIVE MODEL: Type code of the drive FW VERSION: See page 45. SOLUTION PROGRAM: Version information of the active application program BASE SOLUTION PROGRAM: Version information of the application program template STANDARD LIBRARY: Version information of the standard library TECHNOLOGY LIBRARY: Not applicable to the ACQ810 POWER UNIT SERNO: Serial number of the power stage (JPU) MEM UNIT HW SERNO: Serial number in manufacturing the memory unit (JMU) MEM UNIT CONFIG SERNO: Serial number in configuring the memory unit (JMU). Press  to return to the Main menu.	<pre> LOC ↺ DRIVE INFO ——— FW VERSION UIFQ,2010,0, SOLUTION PROGRAM - BASE SOLUTION PROGRAM EXIT   00:00                       </pre>

## ■ Parameter Change Log

In the Parameter Change Log option, you can:

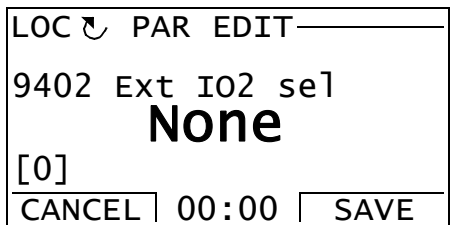
- view latest parameter changes made via control panel or PC tool,
- edit these parameters,
- start, stop, change the direction and switch between local and remote control.

### How to view latest parameter changes and edit parameters

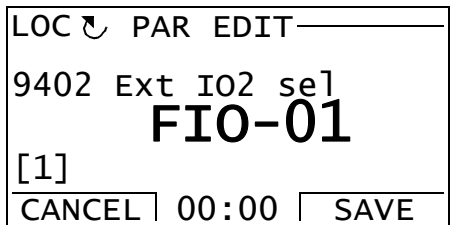
Step	Action	Display
1.	Go to the Main menu by pressing  if you are in the Output mode. Otherwise press  repeatedly until you get to the Main menu.	
2.	Go to the Parameter Change Log option by selecting PAR CHG LOG on the menu with keys  and  , and pressing  . If there are no parameter changes in the history, corresponding text will be shown.  If there are parameter changes in the history, the panel shows a list of the last parameter changes starting from the most recent change. The order of the changes is also indicated with a number in the top right corner (1 stands for most recent change, 2 the second latest change etc.) If a parameter has been changed twice, it is shown as one change in the list. The current value of the parameter and the parameter change date and time are also shown below the selected parameter. You can scroll the parameters with keys  and  .	  
3.	If you want to edit a parameter, select the parameter with keys  and  and press  .	
4.	Specify a new value for the parameter with keys  and  . To save the new value, press  . To cancel the new value and keep the original, press  .	

52 The ACQ810 control panel

Step	Action	Display
5.	<p>The parameter change is shown as the first one in the list of last parameter changes.</p> <p><b>Note:</b> You can reset the parameter change log by setting parameter <a href="#">16.14 Reset ChgParLog</a> to <a href="#">Reset</a>.</p>	<pre> LOC ↵ LAST CHANGES—1 9402 Ext IO2 sel       FIO-01 12.09.2008 15:09:33 9402 Ext IO2 sel 9401 Ext IO1 sel ----- EXIT   00:00   EDIT           </pre>



# Control locations

---

## What this chapter contains

This chapter describes the control locations of the drive.

---

## Local control vs. external control

The drive has two main control locations: external and local. The control location is selected with the LOC/REM key on the control panel or with the PC tool (Take/Release button).

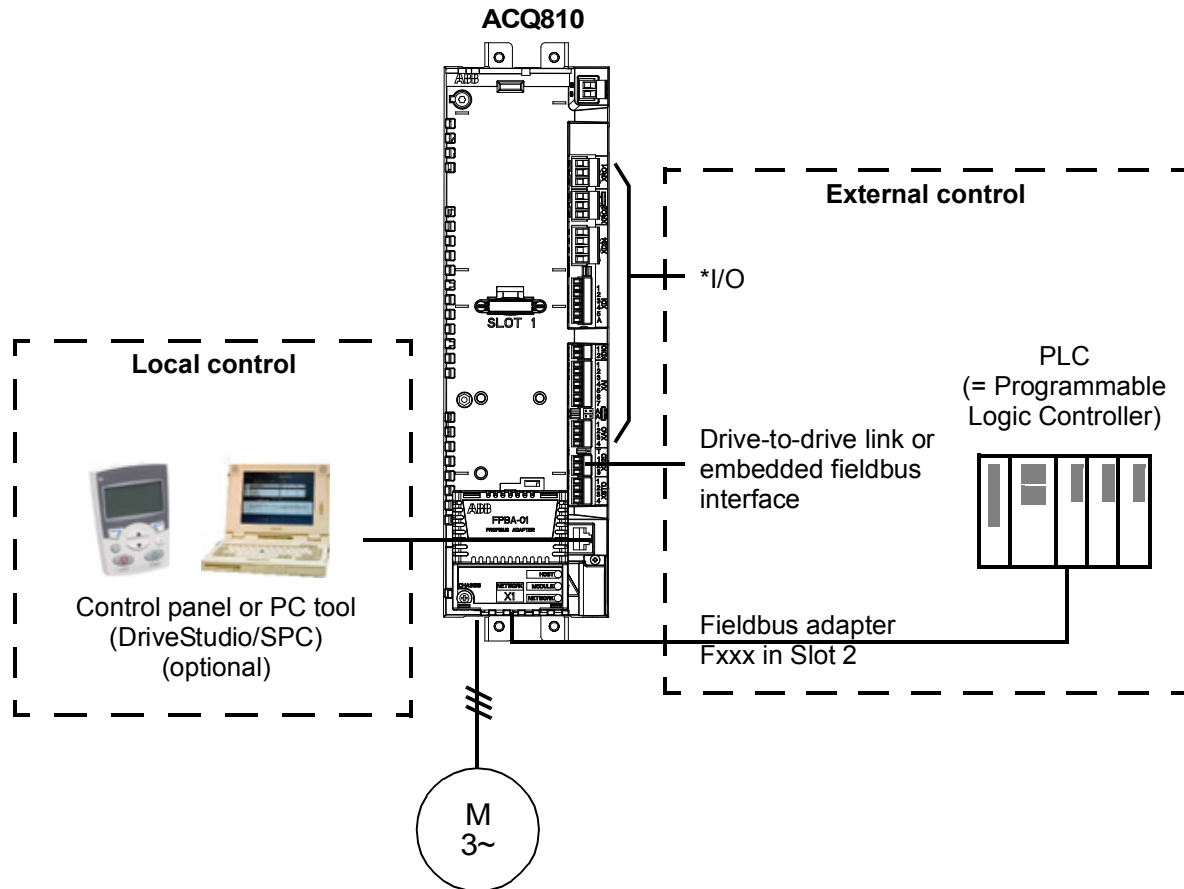

\*Extra inputs/outputs can be added by installing an optional I/O extension module (FIO-xx) into drive Slot 1.

### ■ Local control

The control commands are given from the control panel keypad or from a PC equipped with DriveStudio when the drive is in local control. A speed control mode is available for local control.

Local control is mainly used during commissioning and maintenance. The control panel always overrides the external control signal sources when used in local control. Changing the control location to local can be disabled by parameter [16.01 Local lock](#).

The user can select by a parameter ([30.03 Panel ctrl loss](#)) how the drive reacts to a control panel or PC tool communication break.

## ■ External control

When the drive is in external control, control commands are given through the fieldbus interface (via the embedded fieldbus interface or an optional fieldbus adapter module), the I/O terminals (digital and analog inputs), optional I/O extension modules or the drive-to-drive link. External references are given through the fieldbus interface, analog inputs, or drive-to-drive link.

Two external control locations, EXT1 and EXT2, are available. The user can select control signals (e.g. start and stop) and control modes separately for both external control locations. Depending on the user selection, either EXT1 or EXT2 is active at a time. Selection between EXT1/EXT2 is done via digital signal or fieldbus control word.

---





## 4

# Program features

---

## What this chapter contains

This chapter describes the features of the control program.

## Drive configuration and programming

The drive control program is divided into two parts:

- firmware program
- application program.

### Drive control program

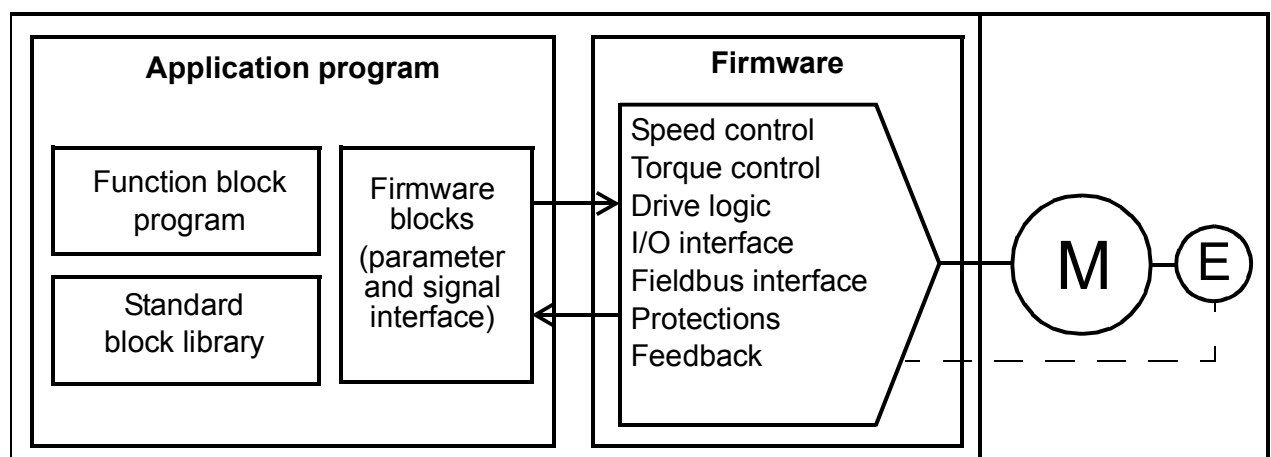

The firmware program performs the main control functions, including speed and torque control, drive logic (start/stop), I/O, feedback, communication and protection functions. Firmware functions are configured and programmed with parameters.

---

## ■ Programming via parameters

Parameters can be set via

- the control panel, as described in chapter [The ACQ810 control panel](#)
- the DriveStudio PC tool, as described in *DriveStudio User Manual* (3AFE68749026 [English]), or
- the fieldbus interface, as described in chapters [Control through the embedded fieldbus interface](#) and [Control through a fieldbus adapter](#).

All parameter settings are stored automatically to the permanent memory of the drive. However, if an external +24 V DC power supply is used for the drive control unit, it is highly recommended to force a save by using parameter [16.07 Param save](#) before powering down the control unit after any parameter changes.

If necessary, the default parameter values can be restored by parameter [16.04 Param restore](#).

**Note:** In case only part of the parameters are visible, set parameter [16.21 Menu selection](#) to *Full*.

## ■ Application programming

The functions of the firmware program can be extended with application programming. (A standard drive delivery does not include an application program.) Application programs can be built out of function blocks based on the IEC-61131 standard. Some drive parameters are used as firmware function block inputs and can therefore be modified also via the application program. Note that parameter changes made via the application program override changes made via the DriveStudio PC tool.

For more information, see

- *Application guide: Application programming for ACS850 and ACQ810 drives* (3AUA0000078664 [English]), and
- *DriveSPC User manual* (3AFE68836590 [English]).

## Application program licensing and protection

The drive can be assigned an application licence consisting of an ID and password using the DriveSPC tool. Likewise, the application program created in DriveSPC can be protected by an ID and password.

If a protected application program is downloaded to a licensed drive, the IDs and passwords of the application and drive must match. A protected application cannot be downloaded to an unlicensed drive. On the other hand, an unprotected application can be downloaded to a licensed drive.

The ID of the application licence is displayed by DriveStudio in the drive software properties as APPL LICENCE. If the value is 0, no licence has been assigned to the drive.

---

**Notes:**

- The application licence can only be assigned to a complete drive, not a stand-alone control unit.
  - A protected application can only be downloaded to a complete drive, not a stand-alone control unit.
-

## Pump control features

### ■ PID control

There is a built-in PID controller in the drive. The controller can be used to control process variables such as pressure, flow or fluid level.

In process PID control, a process setpoint (reference) is connected to the drive instead of a speed reference. A process actual value (feedback) is also brought back to the drive. The process PID control adjusts the drive speed in order to keep the measured process quantity (actual value) at the desired level (setpoint). The control program allows switching between two different setpoints and actual values.

The simplified block diagram below illustrates the process PID control. For a more detailed diagram, see page [398](#).

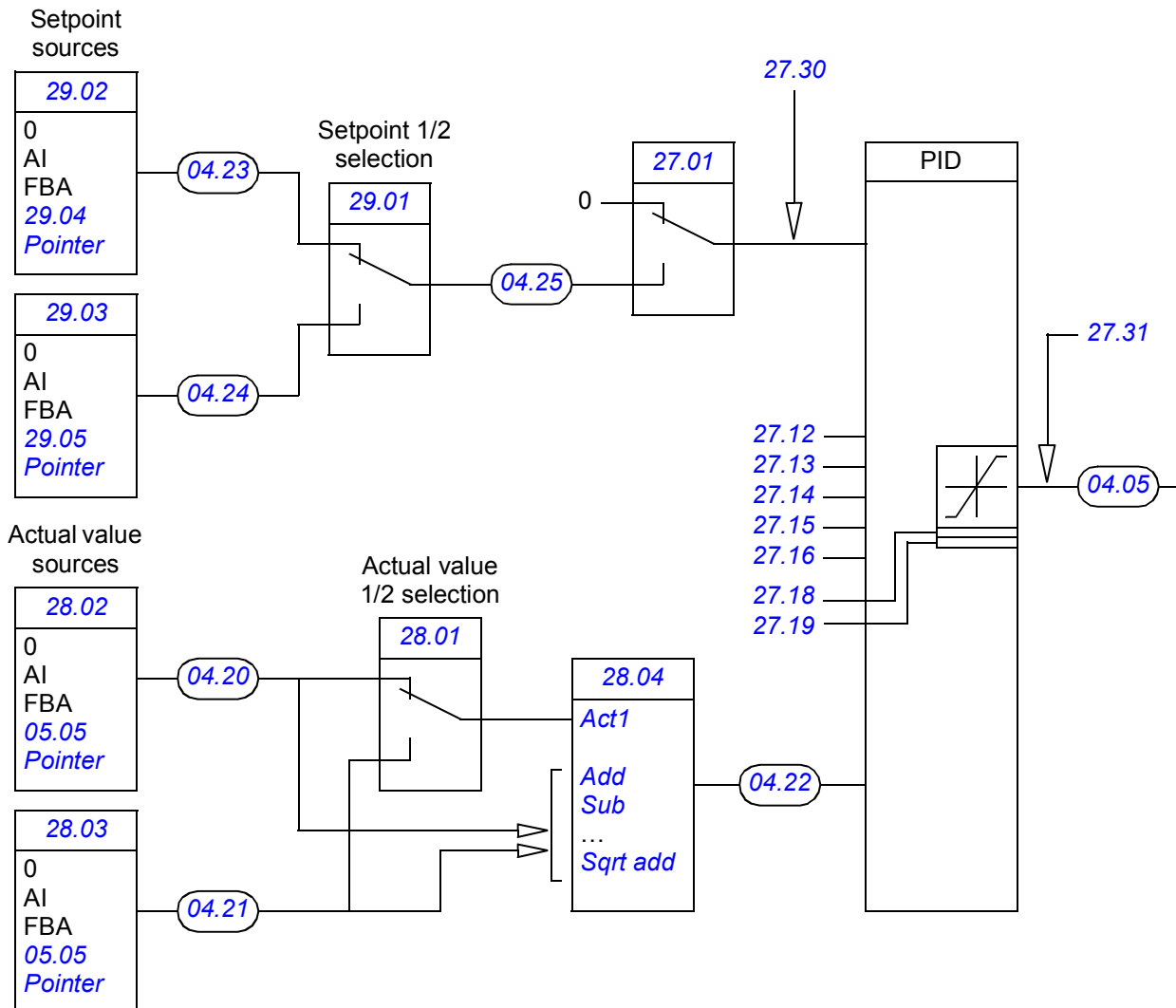

**Note:** PID control works only in external control location EXT2.

## Settings

Parameter groups [12 Operating mode](#) (page 152), [27 Process PID](#) (page 199), [28 Procact sel](#) (page 203), and [29 Setpoint sel](#) (page 205).

## Diagnostics

Parameters [04.01...04.05](#) (page 129), [04.20...04.25](#) (page 130) and [06.20 Pump status word](#) (page 137).

### ■ Sleep function

The sleep function is suitable for PID control applications where the consumption varies, such as clean water pumping systems. When used, it stops the pump completely during low demand, instead of running the pump slowly below its efficient operating range. The following example visualizes the operation of the function.

The drive controls a pressure boost pump. The water consumption falls at night. As a consequence, the process PID controller decreases the motor speed. However, due to natural losses in the pipes and the low efficiency of the centrifugal pump at low speeds, the motor would never stop rotating. The sleep function detects the slow rotation and stops the unnecessary pumping after the sleep delay has passed. The drive shifts into sleep mode, still monitoring the pressure. The pumping resumes when the pressure falls under the predefined minimum level and the wake-up delay has passed.

---

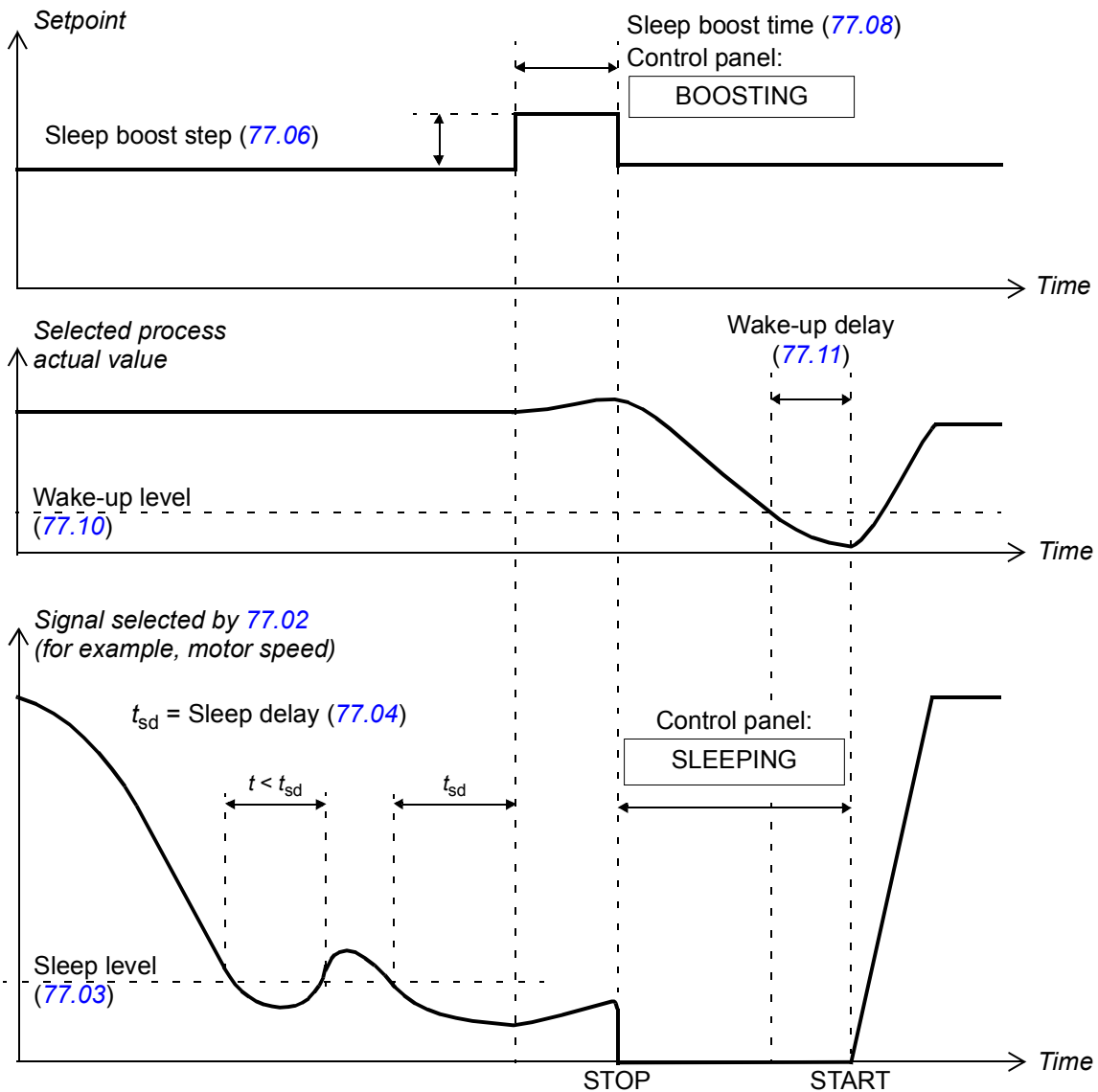

**Note:** The sleep function works only in external control location EXT2.

### Settings

Parameter group [77 Pump sleep](#) (page [271](#)).

### Diagnostics

Parameters [04.26 Wake up level](#) (page [130](#)), [06.02 Status word2](#) (page [134](#)), [06.20 Pump status word](#) (page [137](#)) and [08.21 Pump alarm word](#) (page [143](#)).

## ■ Soft pipefill

Filling up an empty system using normal PID control would cause a sudden pressure peak. To avoid this, a soft pipefill function is available. This involves running the pump at a lower speed until a predefined threshold of process actual value (for example, measured pressure) is achieved. If a specified increase in the actual value is not achieved within a specified time, pump speed is stepped up. This is repeated until the process actual value reaches the threshold level, after which normal process PID control is resumed. A timeout for the whole pipefill phase can also be defined.

The following drawing illustrates the operation of the pipefill function.

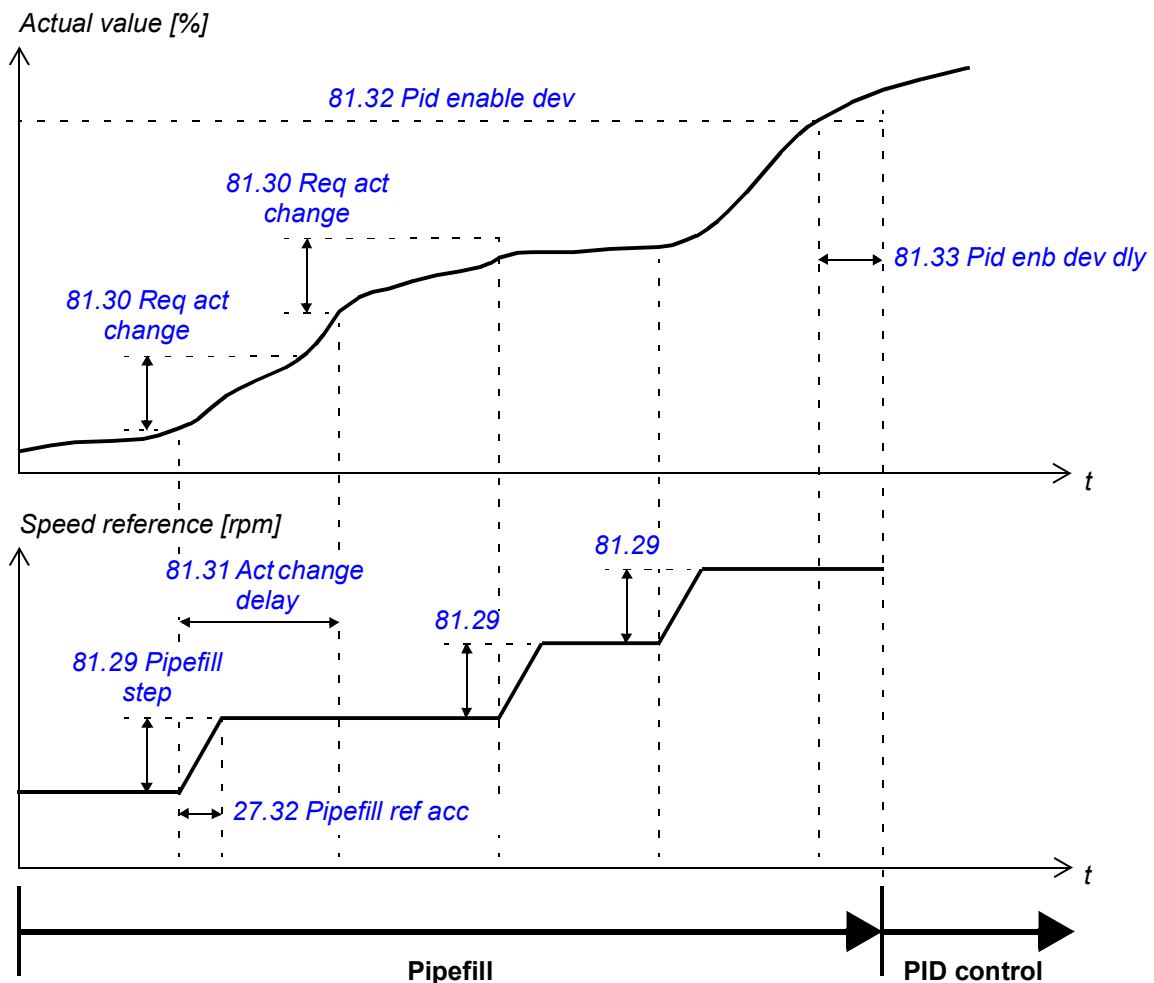

**Note:** The pipefill function works only in external control location EXT2.

### Settings

Parameters [27.32 Pipefill ref acc](#) (page 202) and [27.33 Pipefill ref dec](#) (page 202); parameter group [81 Pump protection](#) (page 288).

## Diagnostics

Parameters [06.20 Pump status word](#) (page 137), [08.20 Pump fault word](#) (page 143) and [08.21 Pump alarm word](#) (page 143).

### ■ Autochange

The Autochange function can be used to equalize duty time between multiple pumps by varying the sequence in which pumps are started as the required pumping capacity increases.

There are three autochange modes selectable by parameter [78.01 Autochg style](#):

- Fixed intervals (*Fixed*): The starting sequence is shifted periodically at pre-defined intervals (parameter [78.05 Autochg interval](#)). In traditional pump control, the pump speed must also be below the level defined by parameter [78.04 Autochg level](#).
- Runtime equalization (*Hourcount*): The starting sequence is rearranged when the difference between the runtimes of two pumps exceed a limit, [78.15 Runtime diff](#). In the new sequence, the pump with the lowest runtime will be started first, the pump with the highest runtime will be started last.
- Autochange when stopped (*All stop*): The starting sequence is shifted every time the drive (in traditional pump control) or the master drive (in multipump or level control) stops.

All pumps take part in the autochange sequence, except in a traditional pump control configuration where a fixed pump is controlled by the drive at all times and the remaining pumps are only turned on/off by the drive logic (an example is shown starting on page [102](#)). In this case, the fixed pump is always started first, and the starting sequence of the auxiliary pumps is determined by the autochange function.

**Note:** The Autochange function works in external control location EXT2. In addition, a part of the Autochange logic is used in traditional pump control configuration where the pump controlled by the drive can be changed using contactors (an example is shown starting on page [105](#)). If this kind of configuration is used in control location EXT1, and the pump connected to the drive is interlocked, the drive logic connects to another pump according to the autochange sequence.

## Settings

Parameter group [78 Pump autochange](#) (page [274](#)).

## Diagnostics

Parameters [04.29...04.36](#) (pump runtime counters; page [130](#)), [05.02 Trad pump cmd](#) (page [131](#)), [05.03 Trad master](#) (page [131](#)), [05.04 Nbr aux pumps on](#) (page [131](#)), [05.36 First in order](#) (page [132](#)), [05.37 Time autochg](#) (page [132](#)), [06.20 Pump status word](#) (page [137](#)), [08.21 Pump alarm word](#) (page [143](#)).

---



## ■ Flow calculation

The flow calculation function provides a reasonably accurate (typically  $\pm 3...6\%$ ) calculation of the flow without the installation of a separate flow meter. The flow is calculated on the basis of parameter data such as pump inlet and outlet diameters, pressure at pump inlet and outlet, height difference of pressure sensors, and pump characteristics.

The user can either define a PQ (power/flow) or HQ (head/flow) performance curve that is used as the basis for the calculation. It is also possible to use both curve types together with a breakpoint setting.

### Notes:

- The flow calculation function is not to be used for invoicing purposes.
- The flow calculation function cannot be used outside the normal operating range of the pump.

### Settings

Parameter group [80 Flow calculation](#) (page [284](#)). The presence of pressure sensors in the system determines which parameters should be set; refer to the following table for recommendations.

Parameter	Without pressure sensors	With pressure sensors
<a href="#">80.01 Flow calc mode</a>	Typically <a href="#">PQ curve</a>	Typically <a href="#">HQ curve</a>
<a href="#">80.02 Pump inlet sel</a>	Not required	Required
<a href="#">80.03 Pump outlet sel</a>	Not required	Required
<a href="#">80.04...80.13</a> (HQ curve definition)	Typically not required	Typically required
<a href="#">80.14...80.23</a> (PQ curve definition)	Typically required	Typically not required
<a href="#">80.25 Pump inlet diam</a>	Not required	Required
<a href="#">80.26 Pump outlet diam</a>	Not required	Required
<a href="#">80.27 Sensors hgt diff</a>	Not required	Required
<a href="#">80.28 Pump nom speed</a>	Required	Required
<a href="#">80.29 Density</a>	Not required	Required
<a href="#">80.30 Efficiency</a>	Required	Not required
<a href="#">80.31 Flow calc gain</a>	Optional correction factor	
<a href="#">80.32 Calc low sp</a>	Optional pump speed low limit for calculation	

### Diagnostics

Parameters [05.05...05.08](#) (page [131](#)).

## ■ Pump cleaning

The drive has a pump cleaning function that can be used to prevent solids from building up on pump impellers or piping. The function consists of a programmable sequence of forward and reverse runs of the pump to shake off any residue on the impeller or piping. This is especially useful with booster and wastewater pumps.

The cleaning sequence can be programmed to occur at suitable intervals, or whenever certain triggering conditions are met. By default, the cleaning sequence is started in the forward direction, but it can also be started in the reverse direction.

To rotate the pump in the reverse direction, you must set parameter [20.02 Minimum speed](#) to a negative value, enable a negative speed reference using parameter [20.04 Neg speed ena](#), and then define the reverse step frequency using parameter [82.03 Second Step](#).

**Note:** Not all pumps can be rotated in the reverse direction.

### Settings

Parameter group [82 Pump cleaning](#) (page [296](#)).

### Diagnostics

Parameters [06.20 Pump status word](#) (page [137](#)), [08.20 Pump fault word](#) (page [143](#)) and [08.21 Pump alarm word](#) (page [143](#)).

## ■ Protective functions

### Pressure monitoring

The control program contains protective functions for two-level analog or single-level digital pressure monitoring of both the inlet and outlet of the pump.

In analog monitoring, whenever the pressure being monitored meets the first limit, the drive indicates a warning, trips on a fault, or starts to follow a pre-defined reference. When the second limit is met, the drive either stops or trips on a fault.

In digital pressure monitoring, one limit is observed. Whenever the limit is met, the drive indicates an alarm, trips on a fault, or starts to follow a pre-defined reference.

### Flow monitoring

The control program has a monitoring function for flow that can be configured to generate an alarm or a fault whenever the flow falls below or rises above predefined limits.

The flow can either be calculated or measured using a flow meter connected to, for example, an analog input.

---

## Application profile monitoring

The application profile monitoring function can be used for long-term supervision of an actual signal. If the selected signal remains above the supervision limit for a specified time, an alarm is generated.

For example, monitoring the deviation between the PID controller setpoint and actual value (parameter [04.04 Process PID err](#)) gives an indication of the general condition of the pump, piping and valves. On the other hand, the PID controller output (parameter [04.05 Process PID out](#)) remaining at 100% for a long time would indicate a leak in the outlet piping.

## Settings

Parameter group [81 Pump protection](#) (page [288](#)).

## Diagnostics

Parameters [06.20 Pump status word](#) (page [137](#)), [08.20 Pump fault word](#) (page [143](#)) and [08.21 Pump alarm word](#) (page [143](#)).

---

## ■ Quick ramp mode

The quick ramp mode allows users to define multiple ramp sets to accelerate or decelerate the pump. For example, a quicker ramp time can be used to accelerate the pump to a certain speed, after which a slower standard ramp time is used to control the process in normal operation. In submersible pumps, the mechanical wearing of bearings can be reduced by ramping the pump quickly up to a certain speed.

Either one or two additional ramp sets can be enabled through the quick ramp mode. In parameters [75.33 QR 1/2 swtch](#) and [75.37 QR/NR swtch](#), the user can specify whether the ramp set is changed when the speed reference exceeds a user-defined switchover speed or when the ramp set change is requested by a digital input. Parameter [75.37 QR/NR swtch](#) overrides parameter [75.33 QR 1/2 swtch](#).

The following drawing illustrates acceleration in the quick ramp mode when both additional ramp sets are used.

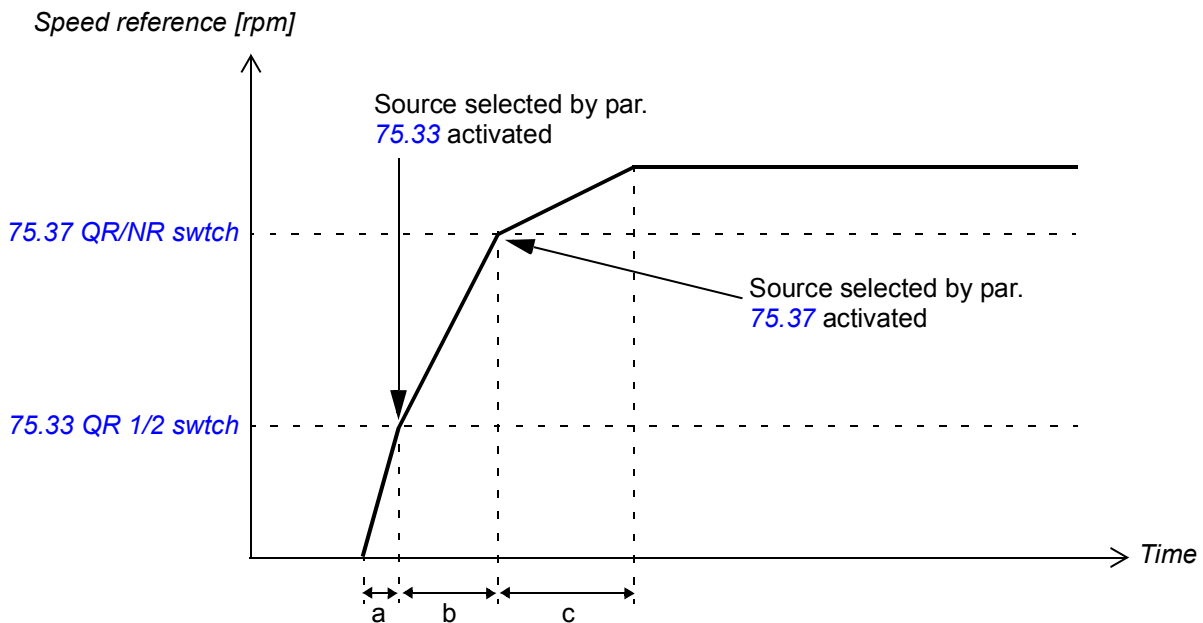

- a Quick ramp set 1 ([75.31](#) and [75.32](#)) active
- b Quick ramp set 2 ([75.35](#) and [75.36](#)) active
- c Standard ramp set ([22.02](#) and [22.03](#)) active

Parameter [19.01 Speed scaling](#) must be used to calculate acceleration and deceleration times for the ramp sets. An example of calculating the acceleration time of quick ramp set 1 ([75.31 Quick ramp acc1](#)) is shown below.

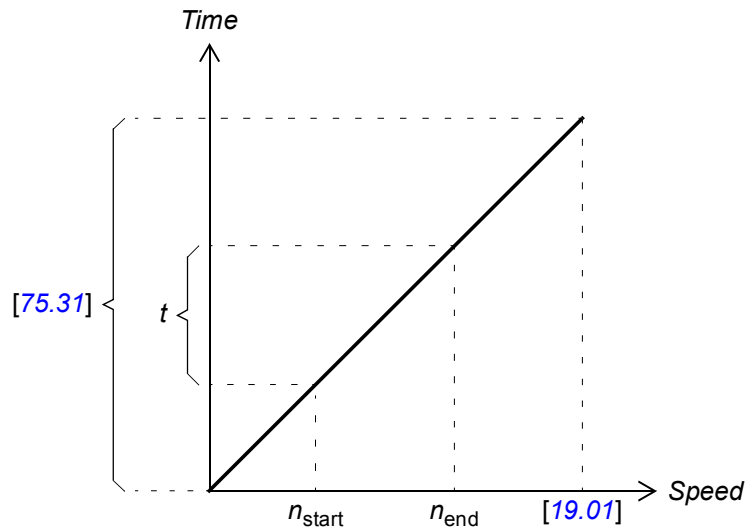

where

$t$  = desired acceleration time

$n_{start}$  = speed at start of acceleration

$n_{end}$  = speed at end of acceleration

To calculate the value of parameter [75.31 Quick ramp acc1](#), use the following equation:

$$\frac{n_{end} - n_{start}}{t} = \frac{[19.01]}{[75.31]}$$

For example, if parameter [19.01 Speed scaling](#) is set to 1500 rpm, and the motor should accelerate from 600 to 1200 rpm in 2 seconds, parameter [75.31 Quick ramp acc1](#) should be set to:

$$\frac{1200-600}{2} = \frac{1500}{[75.31]} \Rightarrow [75.31] = \frac{1500}{300} = 5.00$$

The quick ramp mode works only in the forward direction.

## Settings

Parameters [75.30 Quick ramp mode...](#)[75.38 QR/NR switch spd](#) (page 265).

## Diagnostics

Parameter [05.48 Ramp status](#) (page 132).

## Control interfaces

### ■ Programmable analog inputs

The drive has two programmable analog inputs. Each of the inputs can be independently set as a voltage (0/2...10 V or -10...10 V) or current (0/4...20 mA) input by a jumper on the JCU Control Unit. Each input can be filtered, inverted and scaled. The number of analog inputs can be increased by using FIO-xx I/O extensions.

See also [Pressure sensor connection examples](#) on page 114.

### Settings

Parameter group [13 Analogue inputs](#) (page 153).

### Diagnostics

Parameters [02.04...02.13](#) (page 120).

### ■ Programmable analog outputs

The drive has two programmable current-type analog outputs. Each output can be filtered, inverted and scaled. The number of analog outputs can be increased by using FIO-xx I/O extensions.

### Settings

Parameter group [15 Analogue outputs](#) (page 170).

### Diagnostics

Parameters [02.16...02.19](#) (page 120).

### ■ Programmable digital inputs and outputs

The drive has five digital inputs, a digital start interlock input, and two digital input/outputs.

One digital input (DI5) doubles as a PTC thermistor input. See section [Thermal motor protection](#) on page 83.

One of the digital input/outputs can be used as a frequency input, the other as a frequency output.

The number of digital input/outputs can be increased by using FIO-xx I/O extensions.

### Settings

Parameter group [14 Digital I/O](#) (page 159).

---

## Diagnostics

Parameters [02.01 DI status](#) (page 119), [02.03 DIO status](#) (page 120), [02.20 Freq in](#) (page 120) and [02.21 Freq out](#) (page 120).

### ■ Programmable I/O extensions

The number of inputs and outputs can be increased by using FIO-xx I/O extensions. The drive I/O configuration parameters include the maximum number of DI, DIO, AI, AO and RO that can be taken into use with different FIO-xx combinations.

The table below shows the possible I/O combinations of the drive:

	Digital inputs (DI)	Digital I/O (DIO)	Analog inputs (AI)	Analog outputs (AO)	Relay outputs (RO)
JCU Control Unit	6	2	2	2	2
FIO-01	-	4	-	-	2
FIO-11	-	2	3	1	-
FIO-21	1	-	1	-	2
FIO-31	-	-	-	-	4

For example, with an FIO-21 connected to the drive, parameters controlling DI1...7, DIO1...2, AI1...3, AO1...2 and RO1...4 are in use.

## Settings

Parameter groups [13 Analogue inputs](#) (page 153), [14 Digital I/O](#) (page 159), [15 Analogue outputs](#) (page 170) and [94 Ext IO conf](#) (page 300).

### ■ Programmable relay outputs

The drive has two relay outputs. The signals to be indicated by the outputs can be selected by parameters.

Relay outputs can be added by using FIO-xx I/O extensions.

## Settings

Parameter group [14 Digital I/O](#) (page 159).

## Diagnostics

Parameter [02.02 RO status](#) (page 120).

### ■ Fieldbus control

The drive can be connected to several different automation systems through its fieldbus interface. See chapters [Control through the embedded fieldbus interface](#) (page 355) and [Control through a fieldbus adapter](#) (page 383).

## **Settings**

Parameter groups [50 Fieldbus](#) (page 242), [51 FBA settings](#) (page 245), [52 FBA data in](#) (page 246), [53 FBA data out](#) (page 247) and [58 Embedded Modbus](#) (page 249).

---



## Motor control

### ■ Constant speeds

It is possible to predefine up to 7 constant speeds. Constant speeds can be activated, for example, through digital inputs. Constant speeds override the speed reference.

#### Settings

Parameter group [26 Constant speeds](#) (page [197](#)).

### ■ Critical speeds

A Critical speeds function is available for applications where it is necessary to avoid certain motor speeds or speed ranges because of, for example, mechanical resonance problems.

#### Settings

Parameter group [25 Critical speed](#) (page [196](#)).

### ■ Speed controller tuning

The speed controller of the drive can be automatically adjusted using the autotune function (parameter [23.20 PI tune mode](#)). Autotuning is based on the load and inertia of the motor and the machine. It is, however, also possible to manually adjust the controller gain, integration time and derivation time.

Autotuning can be performed in four different ways depending on the setting of parameter [23.20 PI tune mode](#). The selections *Smooth*, *Middle* and *Tight* define how the drive torque reference should react to a speed reference step after tuning. The selection *Smooth* will produce a slow response; *Tight* will produce a fast response. The selection *User* allows customized control sensitivity adjustment through parameters [23.21 Tune bandwidth](#) and [23.22 Tune damping](#). Detailed tuning status information is provided by parameter [06.03 Speed ctrl stat](#). If the autotuning routine fails, the *AUTOTUNE FAILED* alarm will occur for approximately 15 seconds. If a stop command is given to the drive during the autotuning, the routine is aborted.

The prerequisites for performing the autotune routine are:

- The ID run has been successfully completed
- Speed, torque, current and acceleration limits (parameter groups [20 Limits](#) and [22 Speed ref ramp](#)) are set
- Speed feedback filtering, speed error filtering and zero speed are set (parameter groups [19 Speed calculation](#) and [23 Speed ctrl](#))
- The drive is stopped.

The results of the autotune routine are automatically transferred into parameters

- [23.01 Proport gain](#) (proportional gain of the speed controller)
-

- **23.02 Integration time** (integration time of the speed controller)
- **01.31 Mech time const** (mechanical time constant of the machinery).

The figure below shows speed responses at a speed reference step (typically 1...20%).

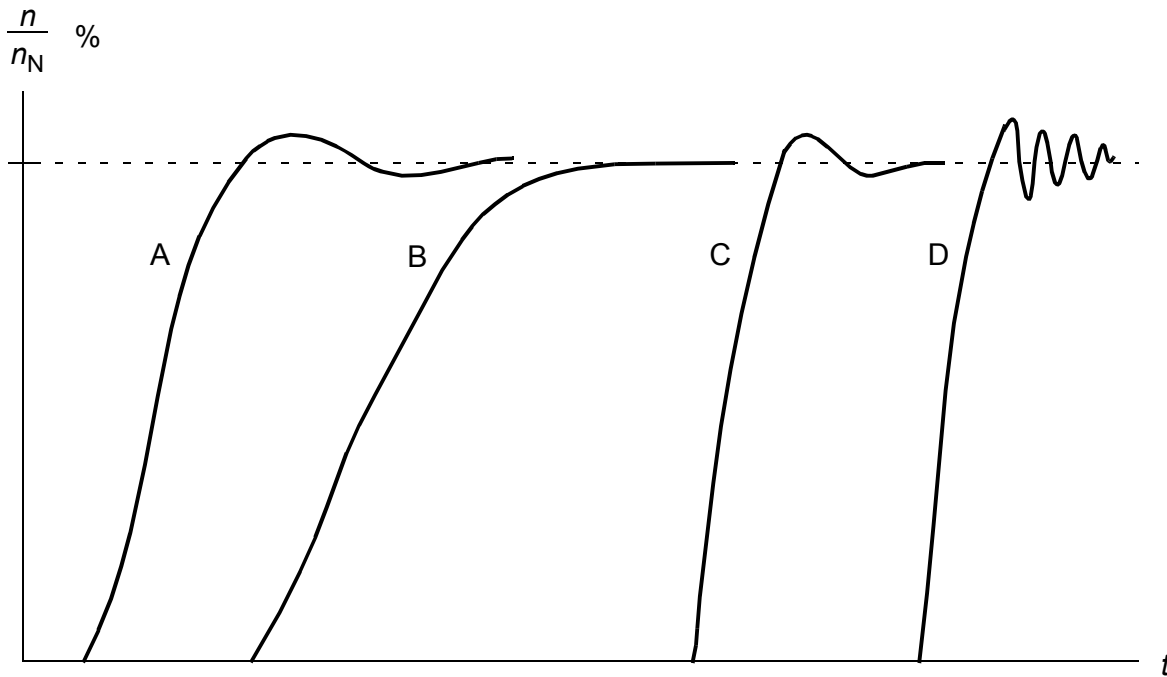

- A: Undercompensated
- B: Normally tuned (autotuning)
- C: Normally tuned (manually). Better dynamic performance than with B
- D: Overcompensated speed controller

The figure below is a simplified block diagram of the speed controller. The controller output is the reference for the torque controller.

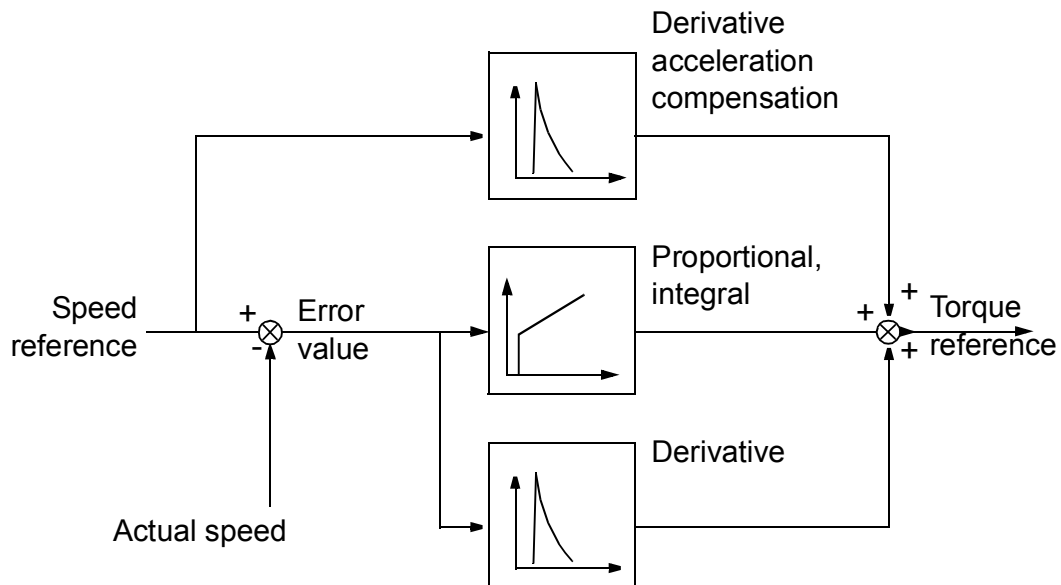

## Settings

Parameter group [23 Speed ctrl](#) (page 188).

## Diagnostics

Parameters [01.01 Motor speed rpm](#) (page 118), [01.02 Motor speed %](#) (page 118) and [01.14 Motor speed est](#) (page 118).

## ■ Scalar motor control

It is possible to select scalar control as the motor control method instead of Direct Torque Control (DTC). In scalar control mode, the drive is controlled with a frequency reference. However, the outstanding performance of DTC is not achieved in scalar control.

It is recommended to activate the scalar motor control mode in the following situations:

- In multimotor drives: 1) if the load is not equally shared between the motors, 2) if the motors are of different sizes, or 3) if the motors are going to be changed after motor identification (ID run)
- If the nominal current of the motor is less than 1/6 of the nominal output current of the drive
- If the drive is used without a motor connected (for example, for test purposes).

In scalar control, some standard features are not available.

## Settings

Parameter [99.05 Motor ctrl mode](#) (page 302).

## IR compensation for a scalar controlled drive

IR compensation is active only when the motor control mode is scalar. When IR compensation is activated, the drive gives an extra voltage boost to the motor at low speeds. IR compensation is useful in applications that require a high break-away torque.

In Direct Torque Control (DTC), no IR compensation is possible or needed.

Motor voltage

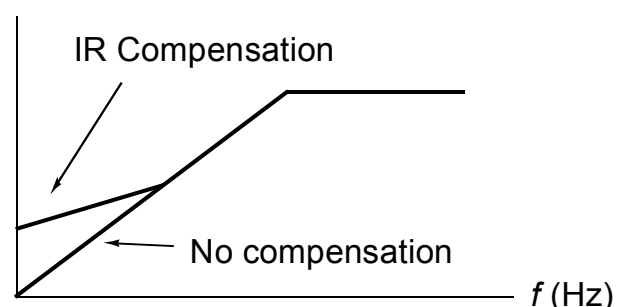

## Settings

Parameter [40.07 IR-compensation](#) (page 233).

## ■ User-definable load curve

The drive output can be limited by defining a load curve. In practice, the user load curve consists of an overload and an underload curve, even though neither is compulsory. Each curve is formed by five points that represent output current or torque as a function of frequency.

An alarm or fault can be set up to occur when the curve is exceeded. The upper boundary (overload curve) can also be used as a torque or current limiter.

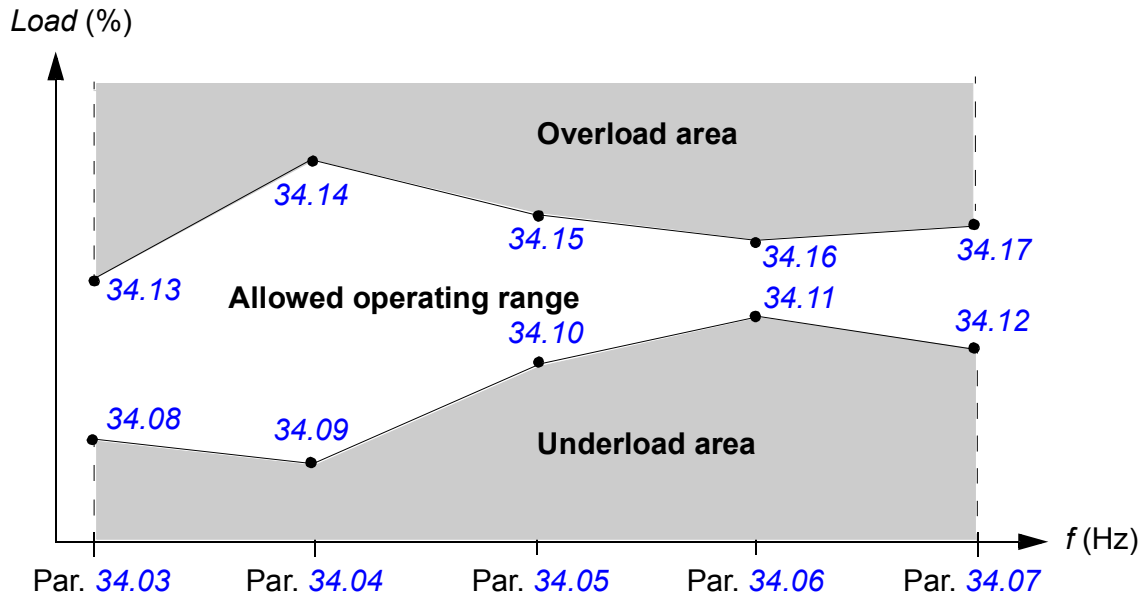

## Settings

Parameter group [34 User load curve](#) (page 218).

## ■ User-definable $U/f$ curve

The user can define a custom  $U/f$  curve (output voltage as a function of frequency). The curve can be used in special applications where linear and quadratic  $U/f$  ratios are not adequate (e.g. when motor break-away torque needs to be boosted).

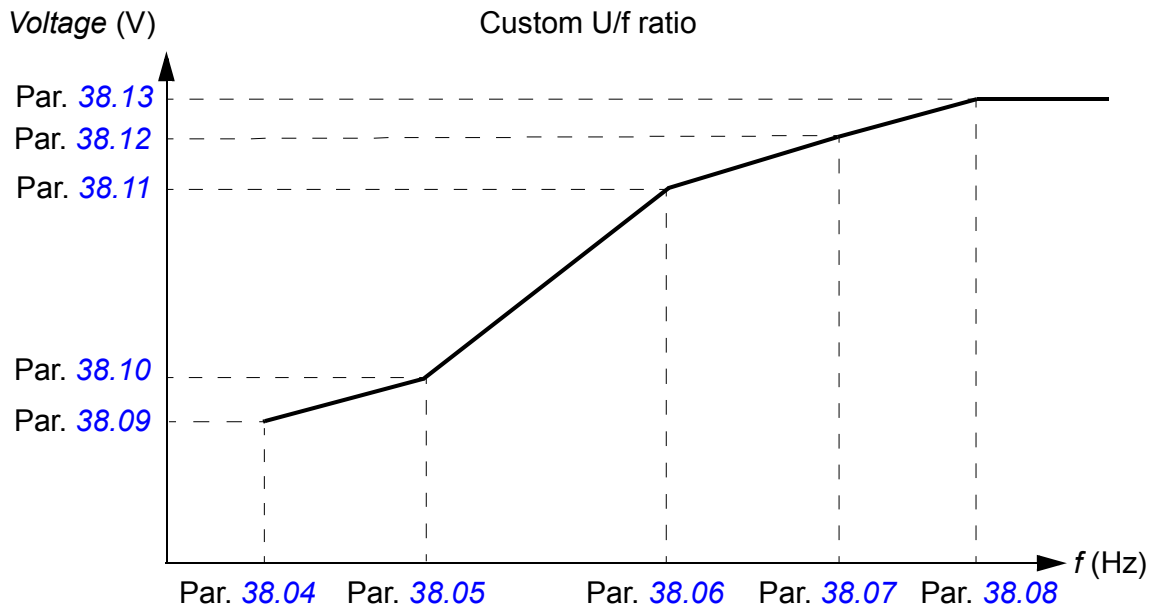

### Notes:

- The  $U/f$  curve can be used in scalar control only, i.e., when parameter [99.05 Motor ctrl mode](#) is set to *Scalar*.
- Each user-defined point defined must have a higher frequency and higher voltage than the previous point.



**WARNING!** High voltage at low frequencies may result in poor performance or motor damage due to overheating.

### Settings

Parameter group [38 Flux ref](#) (page [231](#)).

## ■ Flux braking

The drive can provide greater deceleration by raising the level of magnetization in the motor. By increasing the motor flux, the energy generated by the motor during braking can be converted to motor thermal energy.

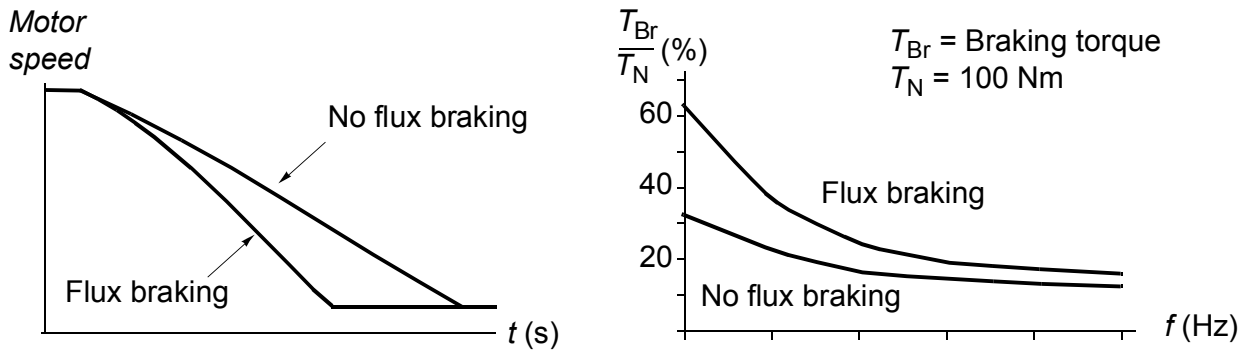

The drive monitors the motor status continuously, also during flux braking. Therefore, flux braking can be used both for stopping the motor and for changing the speed. The other benefits of flux braking are:

- The braking starts immediately after a stop command is given. The function does not need to wait for the flux reduction before it can start the braking.
- The cooling of the induction motor is efficient. The stator current of the motor increases during flux braking, not the rotor current. The stator cools much more efficiently than the rotor. Flux braking can be used only with induction motors.

Two braking power levels are available:

- Moderate braking provides faster deceleration compared to a situation where flux braking is disabled. The flux level of the motor is limited to prevent excessive heating of the motor.
- Full braking exploits almost all available current to convert the mechanical braking energy to motor thermal energy. Braking time is shorter compared to moderate braking. In cyclic use, motor heating may be significant.

## Settings

Parameter [40.10 Flux braking](#) (page [233](#)).

## Application control

### ■ Application macros

See chapter [Application macros](#) (page 93).

### ■ Timers

It is possible to define four different daily or weekly time periods. The time periods can be used to control four different timers. The on/off statuses of the four timers are indicated by bits 0...3 of parameter [06.14 Timed func stat](#), from where the signal can be connected to any parameter with a bit pointer setting (see page 115). In addition, bit 4 of parameter [06.14](#) is on if any one of the four timers is on.

Each time period can be assigned to multiple timers; likewise, a timer can be controlled by multiple time periods.

The figure below presents how different time periods are active in daily and weekly modes.

- Time period 1:** Start time 00:00:00; Stop time 00:00:00 or 24:00:00; Start on Tuesday; Stop day Sunday
- Time period 2:** Start time 03:00:00; Stop time 23:00:00; Start day Wednesday; Stop day Wednesday
- Time period 3:** Start time 21:00:00; Stop time 03:00:00; Start day Tuesday; Stop day Saturday
- Time period 4:** Start time 12:00:00; Stop time 00:00:00 or 24:00:00; Start day Thursday; Stop day Tuesday

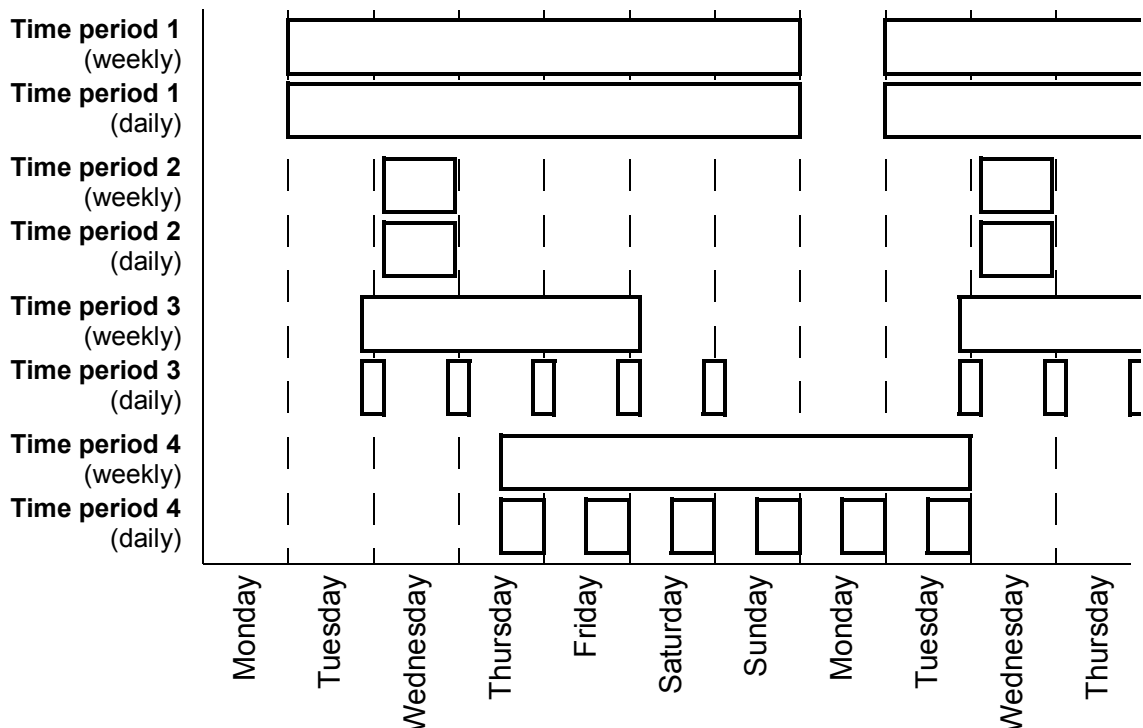

A “boost” function is also available for the activation of the timers: a signal source can be selected to extend the activation time for a parameter-adjustable time period.

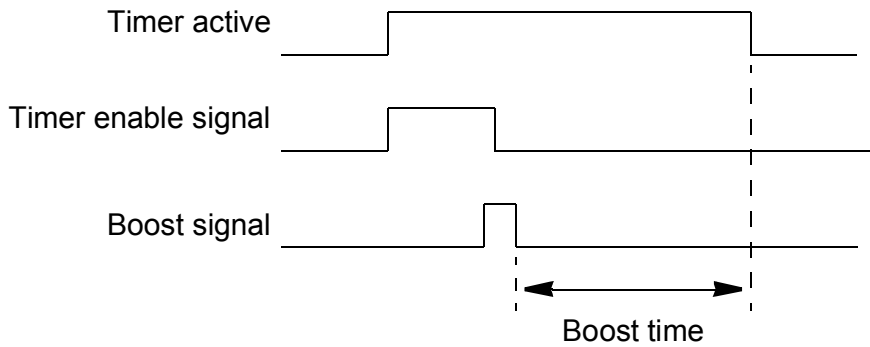

### Settings

Parameter group [36 Timed functions](#) (page [226](#)).

### Diagnostics

Parameter [06.14 Timed func stat](#) (page [136](#)).



## DC voltage control

### ■ Overvoltage control

Overvoltage control of the intermediate DC link is needed with two-quadrant line-side converters when the motor operates within the generating quadrant. To prevent the DC voltage from exceeding the overvoltage control limit, the overvoltage controller automatically decreases the generating torque when the limit is reached.

### ■ Undervoltage control

If the incoming supply voltage is cut off, the drive will continue to operate by utilizing the kinetic energy of the rotating motor. The drive will be fully operational as long as the motor rotates and generates energy to the drive. The drive can continue the operation after the break if the main contactor remained closed.

**Note:** Units equipped with a main contactor must be equipped with a hold circuit (e.g. UPS) to keep the contactor control circuit closed during a short supply break.

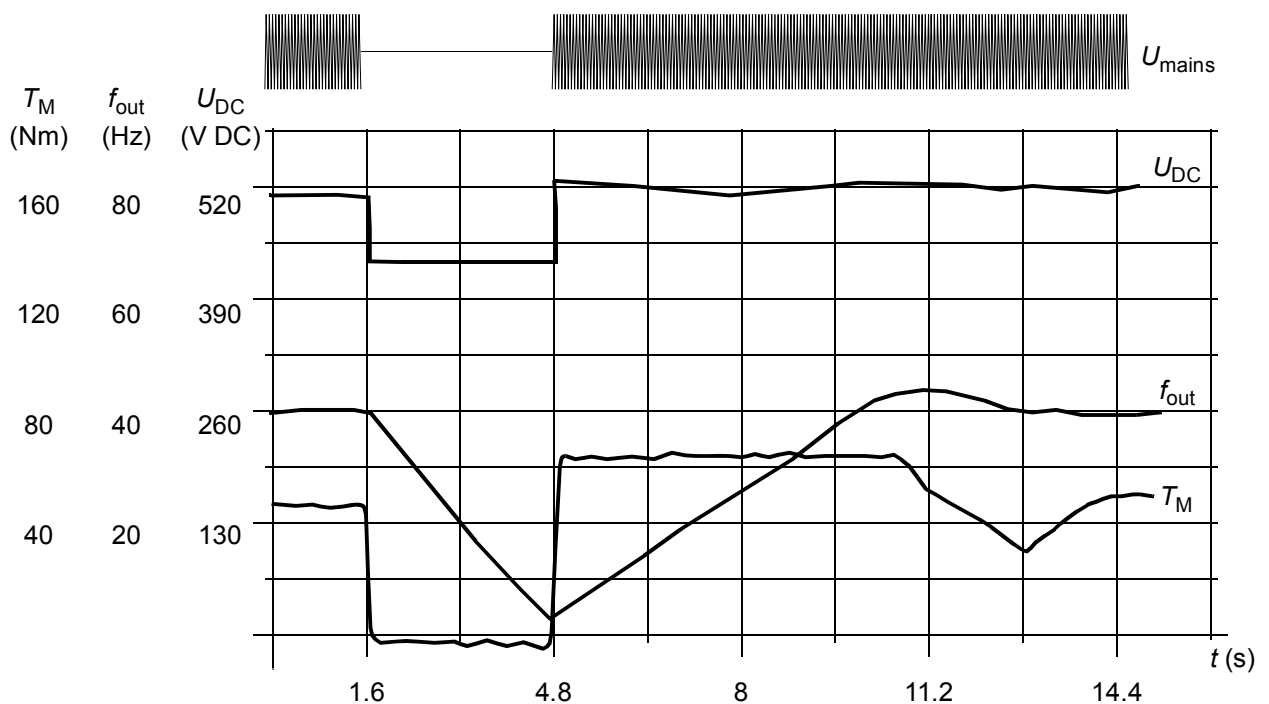

$U_{DC}$  = intermediate circuit voltage of the drive,  $f_{out}$  = output frequency of the drive,  
 $T_M$  = motor torque

Loss of supply voltage at nominal load ( $f_{out} = 40$  Hz). The intermediate circuit DC voltage drops to the minimum limit. The controller keeps the voltage steady as long as the mains is switched off. The drive runs the motor in generator mode. The motor speed falls but the drive is operational as long as the motor has enough kinetic energy.

## ■ Voltage control and trip limits

The control and trip limits of the intermediate DC voltage regulator are relative either to a supply voltage value provided by the user, or to an automatically-determined supply voltage. The actual voltage used is shown by parameter [01.19 Used supply volt](#). The DC voltage ( $U_{DC}$ ) equals 1.35 times this value.

Automatic identification of the supply voltage is performed every time the drive is powered on. Automatic identification can be disabled by parameter [47.03 Sup volt auto Id](#); the user can then define the voltage manually at parameter [47.04 Supply voltage](#).

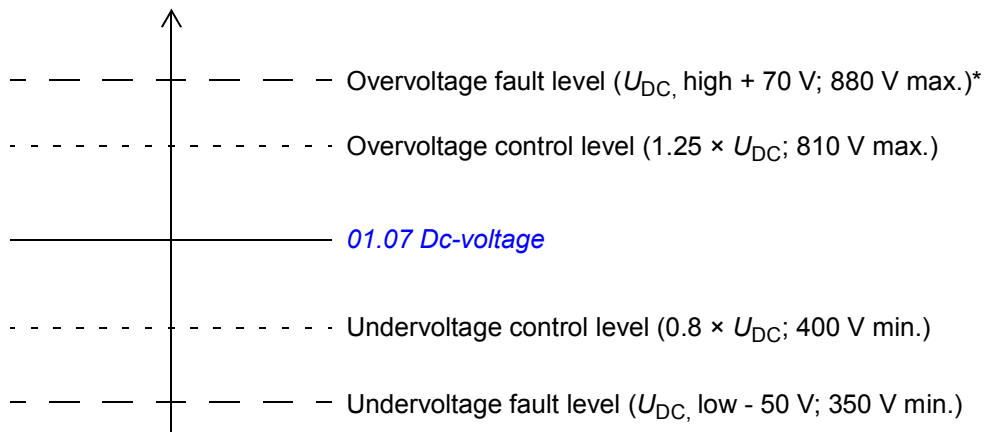

$$U_{DC} = 1.35 \times \text{01.19 Used supply volt}$$

$$U_{DC, \text{ high}} = 1.25 \times U_{DC}$$

$$U_{DC, \text{ low}} = 0.8 \times U_{DC}$$

\*Drives with 230 V supply voltage (ACQ810-04-xxxx-2): The overvoltage fault level is set to 500 V and the minimum levels for undervoltage control and fault are removed.

The intermediate DC circuit is charged over an internal resistor which is bypassed when the capacitors are considered charged and the voltage is stabilized.

### Settings

Parameter group [47 Voltage ctrl](#) (page [241](#)).

### Diagnostics

Parameters [01.07 Dc-voltage](#) (page [118](#)), [01.19 Used supply volt](#) (page [118](#)) and [06.05 Limit word1](#) (page [135](#)).

## Safety and protections

### ■ Emergency stop

**Note:** The user is responsible for installing the emergency stop devices and all the additional devices needed for the emergency stop to fulfil the required emergency stop category classes. For more information, contact your local ABB representative.

The emergency stop signal is to be connected to the digital input which is selected as the source for the emergency stop activation (par. [10.13 Em stop off3](#) or [10.15 Em stop off1](#)). Emergency stop can also be activated through fieldbus ([02.22 FBA main cw](#) or [02.36 EFB main cw](#)).

**Note:** When an emergency stop signal is detected, the emergency stop function cannot be cancelled even though the signal is cancelled.

### ■ Thermal motor protection

The motor can be protected against overheating by

- the motor thermal protection model
- measuring the motor temperature with 1...3 PTC sensors. This will result in a more accurate motor model.

#### Thermal motor protection model

The drive calculates the temperature of the motor on the basis of the following assumptions:

- 1) When power is applied to the drive for the first time, the motor is at ambient temperature (defined by parameter [31.09 Mot ambient temp](#)). After this, when power is applied to the drive, the motor is assumed to be at the estimated temperature.
- 2) Motor temperature is calculated using the user-adjustable motor thermal time and motor load curve. The load curve should be adjusted in case the ambient temperature exceeds 30 °C.

It is possible to adjust the motor temperature supervision limits and select how the drive reacts when overtemperature is detected.

**Note:** The motor thermal model can be used when only one motor is connected to the inverter.

#### Temperature measurement

It is possible to detect motor overtemperature by connecting a motor temperature sensor between +24 V and digital input DI5 on the drive.

Constant current is fed through the sensor. The resistance of the sensor increases as the motor temperature rises over the sensor reference temperature  $T_{ref}$ , as does the voltage over the resistor. The temperature measurement function reads the voltage and converts it into ohms. The limit for overtemperature detection is 2.5 kohm.

---

The figure below shows typical PTC sensor resistance values as a function of the motor operating temperature.

Temperature	PTC resistance
Normal	0...1 kohm
Excessive	$\geq 4$ kohm

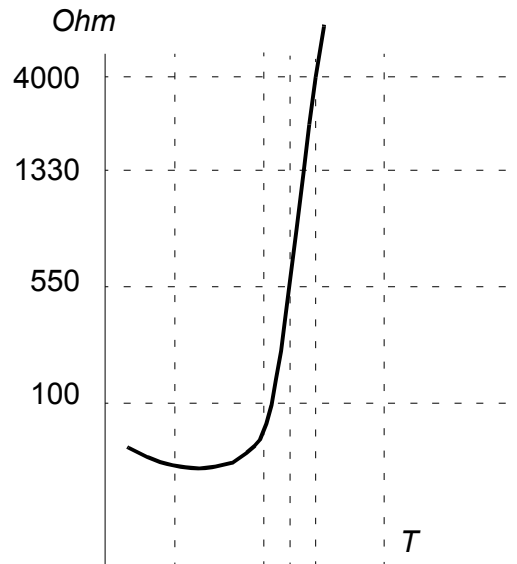

It is possible to adjust the motor temperature supervision limits and select how the drive reacts when overtemperature is detected.

For further information on the wiring, refer to the *Hardware Manual* of the drive.

## Settings

Parameter group [31 Motor therm prot](#) (page [209](#)).

## Diagnostics

Parameters [01.17 Motor temp1](#) (page [118](#)) and [01.18 Motor temp2](#) (page [118](#)).

## ■ Programmable protection functions

### Start interlock (parameter [10.20](#))

The parameter selects how the drive reacts to loss of start interlock signal (DIIL).

### External fault (parameter [30.01](#))

A source for an external fault signal is selected by this parameter. When the signal is lost, a fault is generated.

### Panel control loss detection (parameter [30.03](#))

The parameter selects how the drive reacts to a control panel or PC tool communication break.

### Motor phase loss detection (parameter [30.04](#))

The parameter selects how the drive reacts whenever a motor phase loss is detected.

### Earth fault detection (parameter [30.05](#))

The earth fault detection function is based on sum current measurement. Note that

- an earth fault in the supply cable does not activate the protection
- in a grounded supply, the protection activates within 2 milliseconds
- in an ungrounded supply, the supply capacitance should be 1 microfarad or more
- the capacitive currents caused by shielded motor cables up to 300 metres will not activate the protection
- the protection is deactivated when the drive is stopped.

### Supply phase loss detection (parameter [30.06](#))

The parameter selects how the drive reacts whenever a supply phase loss is detected.

### Safe torque off detection (parameter [30.07](#))

The drive monitors the status of the Safe torque off input. For more information on the Safe torque off function, see the *Hardware Manual* of the drive, and *Application guide - Safe torque off function for ACSM1, ACS850 and ACQ810 drives* (3AFE68929814 [English]).

### Switched supply and motor cabling (parameter [30.08](#))

The drive can detect if the supply and motor cables have accidentally been switched (for example, if the supply is connected to the motor connection of the drive). The parameter selects if a fault is generated or not.

### Stall protection (parameters [30.09...30.12](#))

The drive protects the motor in a stall situation. It is possible to adjust the supervision limits (current, frequency and time) and choose how the drive reacts to a motor stall condition.

## ■ Automatic fault reset

The drive can automatically reset itself after overcurrent, overvoltage, undervoltage, external and “analog input below minimum” faults. By default, automatic resets are off and must be separately activated by the user.

### Settings

Parameter group [32 Automatic reset](#) (page [214](#)).

### Diagnostics

Parameter [08.07 Alarm logger3](#) (page [139](#)).

---

## Diagnostics

### ■ Energy savings calculator

This feature consists of three functionalities:

- An energy optimizer that adjusts the motor flux in such a way that the total efficiency is maximized
- A counter that monitors used and saved energy by the motor and displays them in kWh, currency, or volume of CO<sub>2</sub> emission, and
- A load analyzer showing the load profile of the drive (see section [Load analyzer](#) on page 88).

**Note:** The accuracy of the energy savings calculation is directly dependent on the accuracy of the reference motor power given in parameter [45.08 Pump ref power](#).

### Settings

Parameter group [45 Energy optimising](#) (page 240).

### ■ Energy consumption monitoring

The control program monitors the energy consumption of the drive and pump, and provides the monthly consumption during the last 12 calendar months as actual signals.

There is also a comparison function that generates an alarm if the consumption rises significantly compared to past consumption. The length of a monitoring period is set by a parameter. The energy consumption within the currently running period is compared to a parameter-adjustable limit, the previous monitoring period, or the average of two previous periods. Whenever the consumption within the current period exceeds the reference by a predefined margin (or tolerance), an alarm is given.

### Settings

Parameter group [83 Energy monitoring](#) (page 299).

### Diagnostics

Parameters [05.20...05.35](#) (page 131).

### ■ Signal supervision

Three signals can be selected to be supervised by this function. Whenever the signal exceeds (or falls below) a predefined limit, a bit of [06.13 Superv status](#) is activated. Absolute values can be used.

### Settings

Parameter group [33 Supervision](#) (page 214).

---

## Diagnostics

Parameter [06.13 Superv status](#) (page [136](#)).

### ■ Maintenance counters

The program has six different maintenance counters that can be configured to generate an alarm when the counter reaches a pre-defined limit. The counter can be set to monitor any parameter. This feature is especially useful as a service reminder.

There are three types of counters:

- Ontime counter. Measures the time a digital source (for example, a bit in a status word) is on.
- Rising edge counter. This counter is incremented whenever the monitored digital source changes state from 0 to 1.
- Value counter. This counter measures, by integration, the monitored parameter. An alarm is given when the calculated area below the signal peak exceeds a user-defined limit.

## Settings

Parameter group [44 Maintenance](#) (page [234](#)).

## Diagnostics

Parameters [04.09...04.14](#) (page [129](#)) and [06.15 Counter status](#) (page [136](#)).

---

## ■ Load analyzer

### Peak value logger

The user can select a signal to be monitored by the peak value logger. The logger records the peak value of the signal along with the time the peak occurred, as well as motor current, DC voltage and motor speed at the time of the peak.

### Amplitude loggers

The drive has two amplitude loggers.

For amplitude logger 2, the user can select a signal to be sampled at 200 ms intervals when the drive is running, and specify a value that corresponds to 100%. The collected samples are sorted into 10 read-only parameters according to their amplitude. Each parameter represents an amplitude range 10 percentage points wide, and displays the percentage of the collected samples that fall within that range.

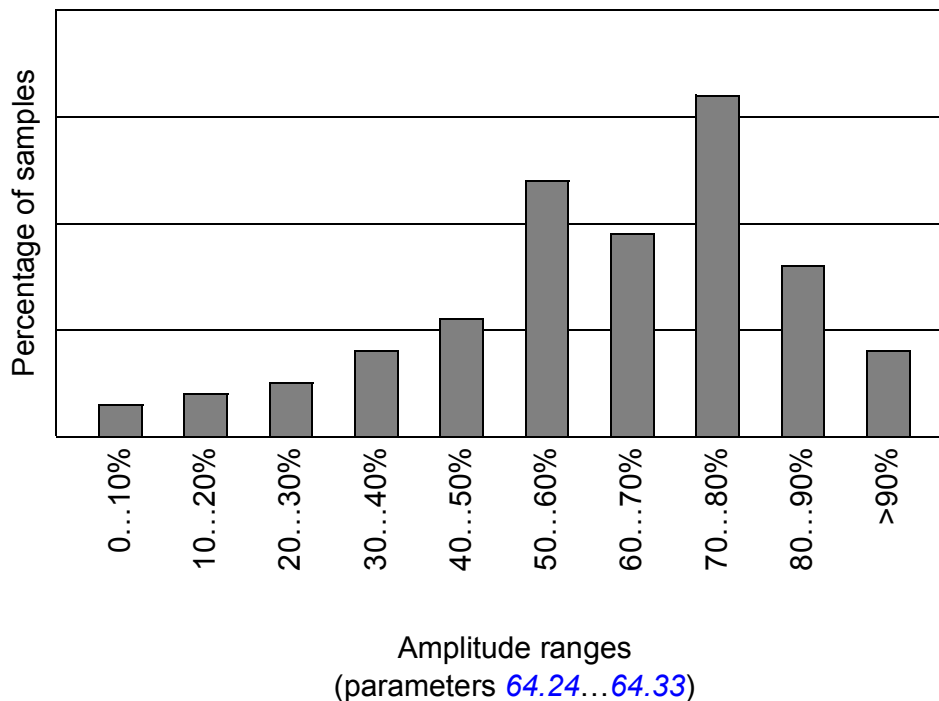

Amplitude logger 1 is fixed to monitor motor current, and cannot be reset. With amplitude logger 1, 100% corresponds to the maximum output current of the drive ( $I_{\max}$ ).

### Settings and diagnostics

Parameter group [64 Load analyzer](#) (page [253](#)).



## Miscellaneous

### ■ Backup and restore of drive contents

#### General

The drive offers a possibility of backing up numerous settings and configurations to external storage such as a PC file (using the DriveStudio tool) and the internal memory of the control panel. These settings and configurations can then be restored to the drive, or a number of drives.

Backup using DriveStudio includes

- Parameter settings
- User parameter sets
- Application program.

Backup using the drive control panel includes

- Parameter settings
- User parameter sets.

For detailed instructions for performing the backup/restore, refer to page [39](#) and the DriveStudio documentation.

#### Limitations

A backup can be done without interfering with drive operation, but restoring a backup always resets and reboots the control unit, so restore is not possible with the drive running.

Restoring backup files from one firmware version to another is considered risky, so the results should be carefully observed and verified when done for the first time. The parameters and application support are bound to change between firmware versions and backups are not always compatible with other firmware versions even if restore is allowed by the backup/restore tool. Before using the backup/restore functions between different firmware versions, refer to the release notes of each version.

Applications should not be transferred between different firmware versions. Contact the supplier of the application when it needs to be updated for a new firmware version.

#### Parameter restore

Parameters are divided into three different groups that can be restored together or individually:

- Motor configuration parameters and identification (ID) run results
  - Fieldbus adapter and encoder settings
  - Other parameters.
-

For example, retaining the existing ID run results in the drive will make a new ID run unnecessary.

Restore of individual parameters can fail for the following reasons:

- The restored value does not fall within the minimum and maximum limits of the drive parameter
- The type of the restored parameter is different from that in the drive
- The restored parameter does not exist in the drive (often the case when restoring the parameters of a new firmware version to a drive with an older version)
- The backup does not contain a value for the drive parameter (often the case when restoring the parameters of an old firmware version to a drive with a newer version).

In these cases, the parameter is not restored; the backup/restore tool will warn the user and offer a possibility to set the parameter manually.

### **User parameter sets**

The drive has four user parameter sets that can be saved to the permanent memory and recalled using drive parameters. It is also possible to use digital inputs to switch between different user parameter sets. See the descriptions of parameters [16.09...16.12](#).

A user parameter set contains all values of parameter groups 10 to 99 (except the configuration settings for fieldbus adapter communication).

As the motor settings are included in the user parameter sets, make sure the settings correspond to the motor used in the application before recalling a user set. In an application where different motors are used with one drive, the motor ID run needs to be performed with each motor and saved to different user sets. The appropriate set can then be recalled when the motor is switched.

### **Settings**

Parameter group [16 System](#) (page [176](#)).

### **■ Data storage parameters**

Four 16-bit and four 32-bit parameters are reserved for data storage. These parameters are unconnected and can be used for linking, testing and commissioning purposes. They can be written to and read from using other parameters' pointer settings.

### **Settings**

Parameter group [49 Data storage](#) (page [242](#)).

---

## ■ Drive-to-drive link

The drive-to-drive (D2D) link is a daisy-chained RS-485 transmission line that allows basic master/follower communication with one master drive and multiple followers.

The drive-to-drive link is used for connecting drives when forming a station with multiple pumps.

### Settings

Parameter group [76 MF communication](#) (page [268](#)).

---





# Application macros

---

## What this chapter contains

This chapter describes the intended use, operation, default control connections, start-up procedure and an application example of each application macro.

More information on the connectivity of the JCU control unit is given in the *Hardware Manual* of the drive.

## General

Application macros are pre-defined parameter sets. When starting up the drive, the user typically selects one of the macros as a basis, makes the essential changes and saves the result as a user parameter set. User parameter sets are managed by the parameters in group [16 System](#) (page [176](#)).

Application macros are activated through the control panel Main menu by selecting ASSISTANTS – Application Macro. A few basic questions about the application appear on the panel; based on the answers, the most suitable macro is applied by the drive. Parameter [16.20 Macro Read Only](#) indicates which application macro is active.

After the activation of an application macro, an assistant can optionally be launched to set up the essential configuration parameters related to the application. Each of these assistants can also be invoked later by selecting ASSISTANTS in the control panel Main menu.

---

## Factory default macro

### ■ Description and typical application

This macro is suitable for a pump station consisting of one drive controlling a single pump. The system can consist of e.g. one ACQ810 drive, one pump, and a sensor. The sensor typically measures either flow or pressure, and is located at the output of the pump.

By default, process reference (setpoint) is set to 40%, but can alternatively be adjusted through e.g. analog input AI1. The process actual value, or feedback signal, should be connected to analog input AI2. The start command is given through digital input DI1.

The sleep function is activated to optimize the energy efficiency of the installation. By default, the drive is stopped if the motor speed is below 20% of its nominal speed for longer than 60 seconds.

### ■ Default settings

See chapter [Additional parameter data](#) (page 307).

---

■ Default control connections for the Factory default macro

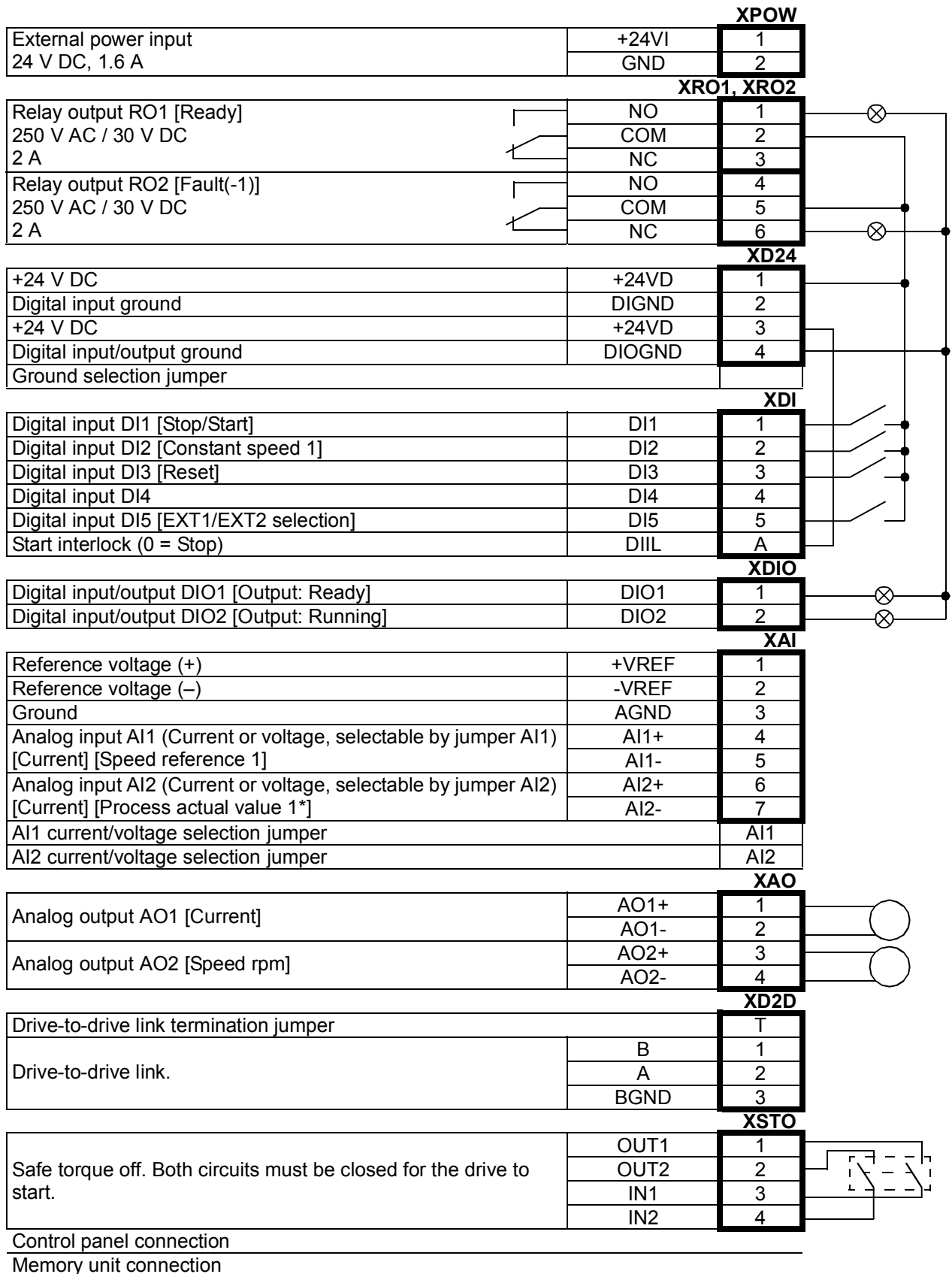

\*See [Pressure sensor connection examples](#) on page 114.

## External control macro

### ■ Description and typical application

The external control macro can be used in single-pump systems where the process is controlled by other devices than the drive. The drive is speed-controlled.

By default, the drive receives a speed reference through analog input AI1. The reference can alternatively be received through one of the supported fieldbus adapters.

### ■ Default settings

Below is a listing of default parameter values that differ from those listed in chapter [Additional parameter data](#) (page 307).

Parameter		External control macro default
No.	Name	
12.01	<i>Ext1/Ext2 sel</i>	<i>Ext1</i>
16.20	<i>Macro Read Only</i>	<i>Ext ctrl</i>
26.02	<i>Const speed sel1</i>	C.FALSE
77.01	<i>Sleep mode sel</i>	<i>Not used</i>



■ Default control connections for the External control macro

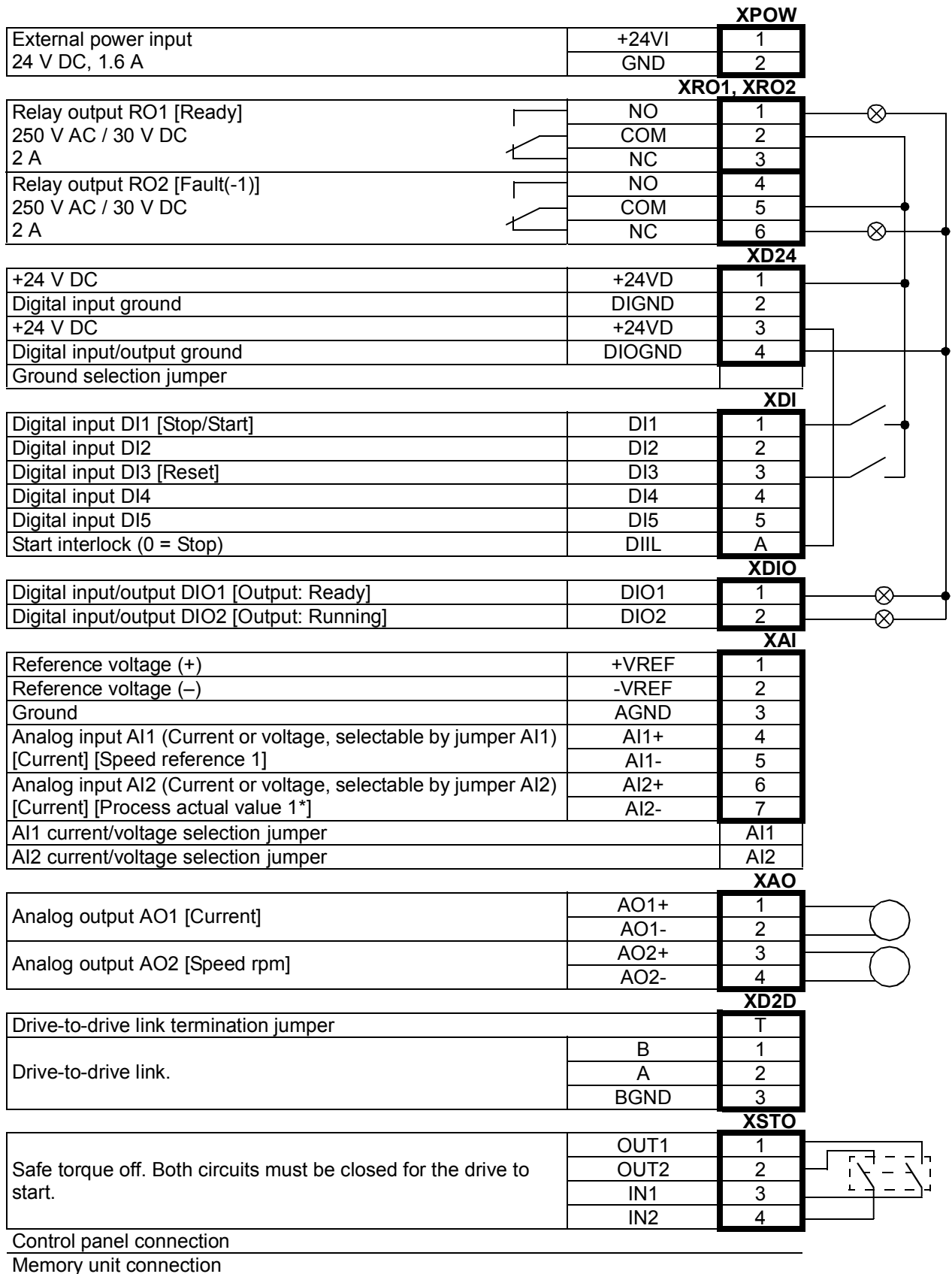

\*See [Pressure sensor connection examples](#) on page 114.

## Hand/Auto control macro

### ■ Description and typical application

Start and stop commands and references (setpoints) can be given from one of two external control locations, EXT1 (Hand) or EXT2 (Auto). The start/stop commands received through EXT1 (Hand) are connected to digital input DI1, while the reference is connected to analog input AI1. The start/stop commands from EXT2 (Auto) are connected to DI2 while the reference is connected to AI2. The selection between Hand/Auto is dependent on the status of DI5. The drive is speed-controlled. The speed reference and start/stop commands can also be given from the control panel.

### ■ Default settings

Below is a listing of default parameter values that differ from those listed in chapter [Additional parameter data](#) (page 307).

Parameter		Hand/Auto macro default
No.	Name	
10.05	<i>Ext2 start in1</i>	<i>DI2</i>
12.05	<i>Ext2 ctrl mode</i>	<i>Speed</i>
16.20	<i>Macro Read Only</i>	<i>Hand/Auto</i>
21.02	<i>Speed ref2 sel</i>	<i>AI2 scaled</i>
26.02	<i>Const speed sel1</i>	C.FALSE
77.01	<i>Sleep mode sel</i>	<i>Not used</i>

**Default control connections for the Hand/Auto control macro**

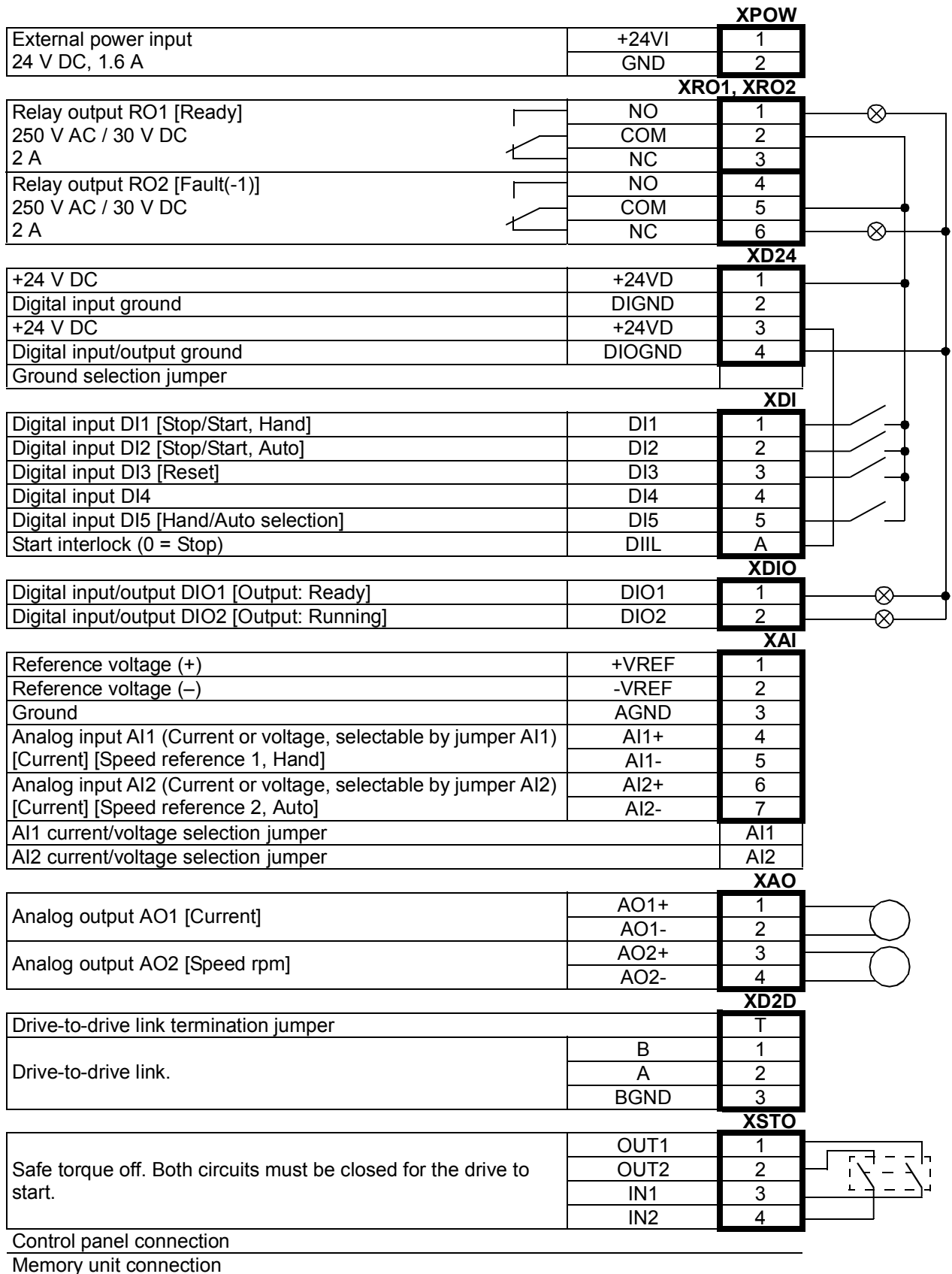

## TRAD (Traditional pump) control macro

### ■ Description and typical application

This macro is suitable for a pump station where one pump at a time is directly controlled by the drive, and the rest of the pumps are direct-on-line and switched on and off by the drive via a relay/contactors system. It is possible to have one pump permanently connected to the drive, or to connect any one of the pumps to the drive using contactors. The drive is capable of controlling up to eight parallel pumps.

By default, process reference (setpoint) is set to 40%, but can alternatively be adjusted through e.g. analog input AI1. The process actual value, or feedback signal, should be connected to analog input AI2. The start command is given through digital input DI1. Relay outputs are used to control auxiliary pumps.

### ■ Default settings

Below is a listing of default parameter values that differ from those listed in chapter [Additional parameter data](#) (page 307).

Parameter		Trad. pump control macro default
No.	Name	
14.07	<i>DIO2 out src</i>	<i>Fault(-1)</i>
14.42	<i>RO1 src</i>	<i>Trad pump1</i>
14.45	<i>RO2 src</i>	<i>Trad pump2</i>
16.20	<i>Macro Read Only</i>	<i>Trad ctrl</i>
26.02	<i>Const speed sel1</i>	C.FALSE
75.01	<i>Operation mode</i>	<i>Trad ctrl</i>
75.02	<i>Nbr of pumps</i>	2
75.25	<i>Drive start dly</i>	1 s
78.01	<i>Autochg style</i>	<i>All stop</i>
78.03	<i>Interlock mode</i>	<i>On</i>
78.06	<i>Interlock pump 1</i>	<i>DI2</i>
78.07	<i>Interlock pump 2</i>	<i>DI4</i>

■ Default control connections for the TRAD macro

		<b>XPOW</b>	
External power input 24 V DC, 1.6 A	+24VI	1	
	GND	2	
		<b>XRO1, XRO2</b>	
Relay output RO1 [Start pump 1] 250 V AC / 30 V DC 2 A	NO	1	
	COM	2	
	NC	3	
Relay output RO2 [Start pump 2] 250 V AC / 30 V DC 2 A	NO	4	
	COM	5	
	NC	6	
		<b>XD24</b>	
+24 V DC	+24VD	1	
Digital input ground	DIGND	2	
+24 V DC	+24VD	3	
Digital input/output ground	DIOGND	4	
Ground selection jumper			
		<b>XDI</b>	
Digital input DI1 [Stop/Start]	DI1	1	
Digital input DI2 [Interlock pump 1]	DI2	2	
Digital input DI3 [Reset]	DI3	3	
Digital input DI4 [Interlock pump 2]	DI4	4	
Digital input DI5 [EXT1/EXT2 selection]	DI5	5	
Start interlock (0 = Stop)	DIIL	A	
		<b>XDIO</b>	
Digital input/output DIO1 [Output: Ready]	DIO1	1	
Digital input/output DIO2 [Output: Fault(-1)]	DIO2	2	
		<b>XAI</b>	
Reference voltage (+)	+VREF	1	
Reference voltage (-)	-VREF	2	
Ground	AGND	3	
Analog input AI1 (Current or voltage, selectable by jumper AI1) [Current] [Speed reference 1]	AI1+	4	
	AI1-	5	
Analog input AI2 (Current or voltage, selectable by jumper AI2) [Current] [Process actual value 1*]	AI2+	6	
	AI2-	7	
AI1 current/voltage selection jumper		AI1	
AI2 current/voltage selection jumper		AI2	
		<b>XAO</b>	
Analog output AO1 [Current]	AO1+	1	
	AO1-	2	
Analog output AO2 [Speed rpm]	AO2+	3	
	AO2-	4	
		<b>XD2D</b>	
Drive-to-drive link termination jumper		T	
Drive-to-drive link.	B	1	
	A	2	
	BGND	3	
		<b>XSTO</b>	
Safe torque off. Both circuits must be closed for the drive to start.	OUT1	1	
	OUT2	2	
	IN1	3	
	IN2	4	
Control panel connection			
Memory unit connection			

\*See [Pressure sensor connection examples](#) on page 114.

## ■ Application examples

### Fixed drive-controlled pump with direct-on-line auxiliary pumps

In this example, the drive always controls the same pump. Auxiliary pumps are connected to the supply through contactors that are controlled by the drive.

Below is a listing of typical parameter values that would be used in this configuration.

Parameter		Trad. pump control macro default
No.	Name	
14.42	<i>RO1 src</i>	<i>Ready</i>
14.45	<i>RO2 src</i>	<i>Trad pump2</i>
14.48	<i>RO3 src</i>	<i>Trad pump3</i>
16.20	<i>Macro Read Only</i>	<i>Trad ctrl</i>
26.02	<i>Const speed sel1</i>	C.FALSE
75.01	<i>Operation mode</i>	<i>Trad ctrl</i>
75.02	<i>Nbr of pumps</i>	3
75.25	<i>Drive start dly</i>	1 s
78.01	<i>Autochg style</i>	<i>All stop</i>
78.02	<i>Autochg trad</i>	<i>Aux</i>
78.03	<i>Interlock mode</i>	<i>On</i>
78.06	<i>Interlock pump 1</i>	<i>DI2</i>
78.07	<i>Interlock pump 2</i>	<i>DI4</i>
78.07	<i>Interlock pump 3</i>	<i>Not used</i>

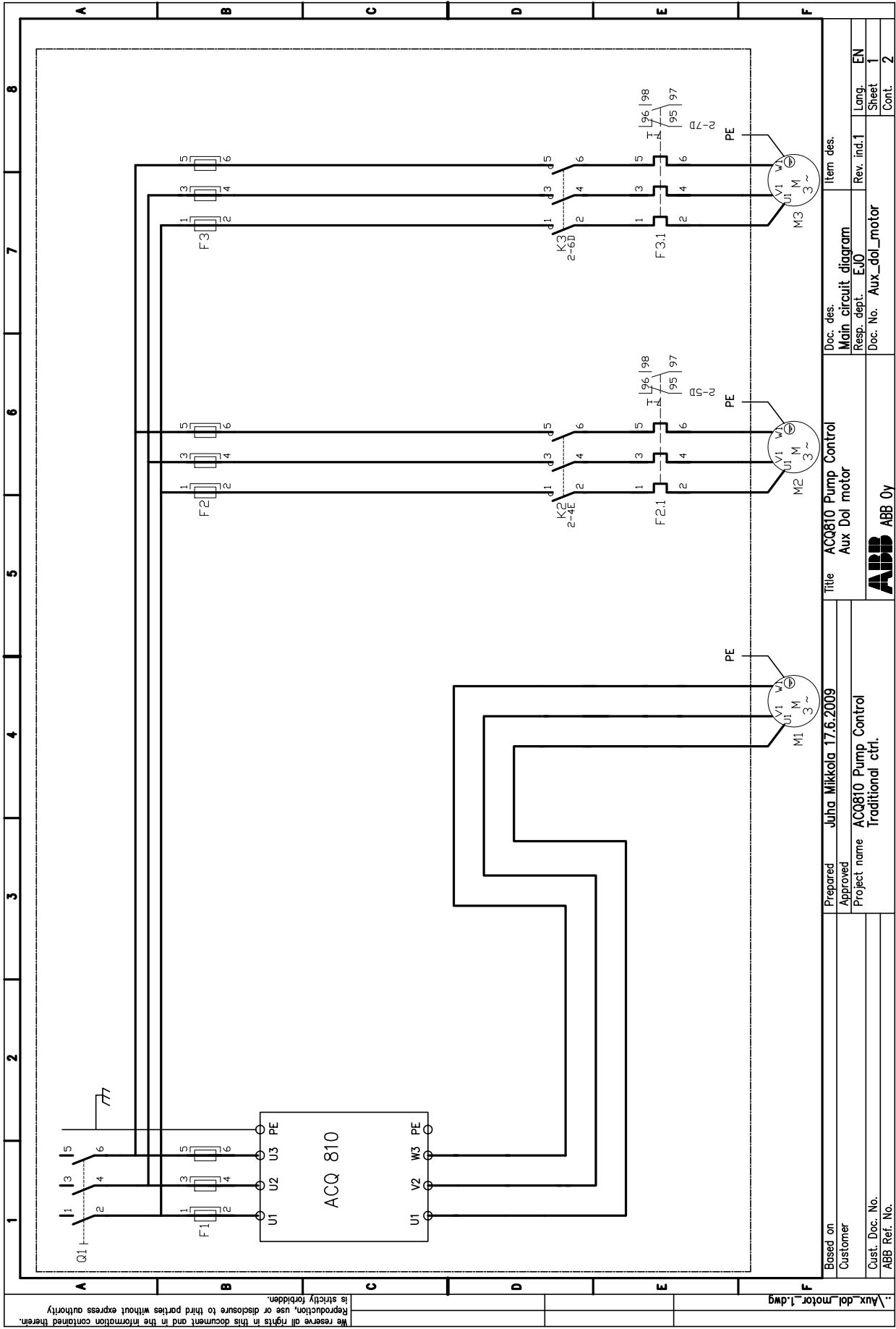

We reserve all rights in this document and in the information contained therein. Reproduction, use or disclosure to third parties without express authority is strictly forbidden.

:\Vux\_dol\_motor\_1.dwg

Based on	Customer	Prepared	Juha Mikkola 17.6.2009	Title	ACQ810 Pump Control	Doc. des.	Item des.
Customer		Approved		Aux Dol motor		Main circuit diagram	
Cust. Doc. No.		Project name	ACQ810 Pump Control	ABB Oy		Resp. dept.	EJO
ABB Ref. No.		Traditional ctrl.				Doc. No.	Aux_dol_motor
						Rev. ind.1	Rev. ind.1
						Lang.	EN
						Sheet	1
						Cont.	2

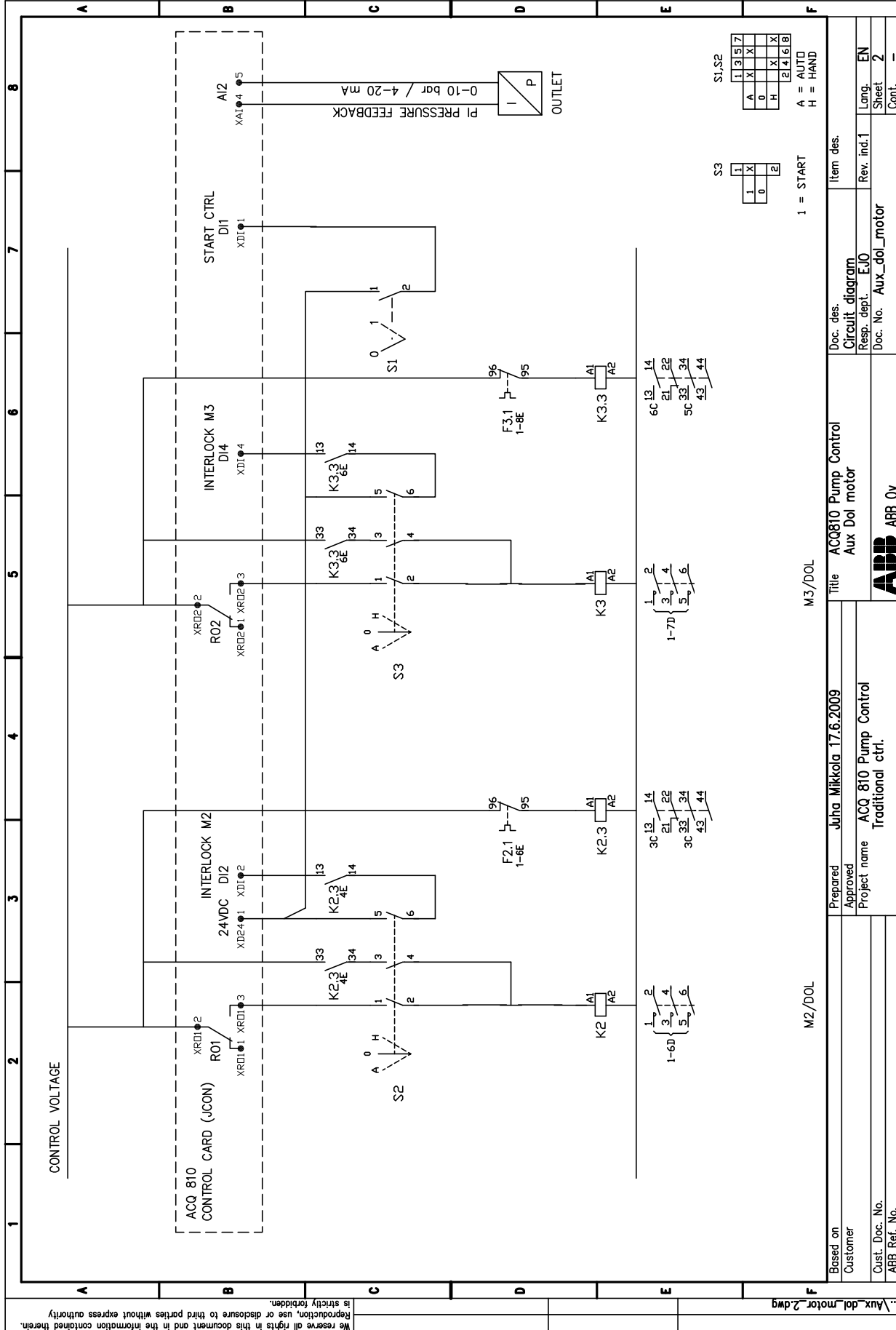

.. Aux\_dol\_motor\_2.dwg  
 We reserve all rights in this document and in the information contained therein.  
 Reproduction, use or disclosure to third parties without express authority  
 is strictly forbidden.

Based on	Customer	Prepared	Juha Mikkola 17.6.2009	Title	M3/DOL	Doc. des.	ACQ810 Pump Control
Approved		Project name	ACO 810 Pump Control	Responsible	EJO	Rev. ind.1	EN
Customer	ABB	ABB Ref. No.	ABB 0y	Doc. No.	Aux_dol_motor	Lang.	Sheet 2
							Cont.



## Pump alternation using contactors

In this example, two pumps both have a contactor configuration that enables them to be connected either to the drive output or the supply. At any given time, one pump is connected to the drive, the other is connected to the supply.

Below is a listing of typical parameter values that would be used in this configuration.

Parameter		Trad. pump control macro default
No.	Name	
14.42	<i>RO1 src</i>	<i>Trad pump1</i>
14.45	<i>RO2 src</i>	<i>Trad pump2</i>
16.20	<i>Macro Read Only</i>	<i>Trad ctrl</i>
26.02	<i>Const speed sel1</i>	C.FALSE
75.01	<i>Operation mode</i>	<i>Trad ctrl</i>
75.02	<i>Nbr of pumps</i>	2
75.25	<i>Drive start dly</i>	1 s
78.01	<i>Autochg style</i>	<i>All stop</i>
78.02	<i>Autochg trad</i>	<i>All</i>
78.03	<i>Interlock mode</i>	<i>On</i>
78.06	<i>Interlock pump 1</i>	<i>DI2</i>
78.07	<i>Interlock pump 2</i>	<i>DI4</i>
78.07	<i>Interlock pump 3</i>	<i>Not used</i>

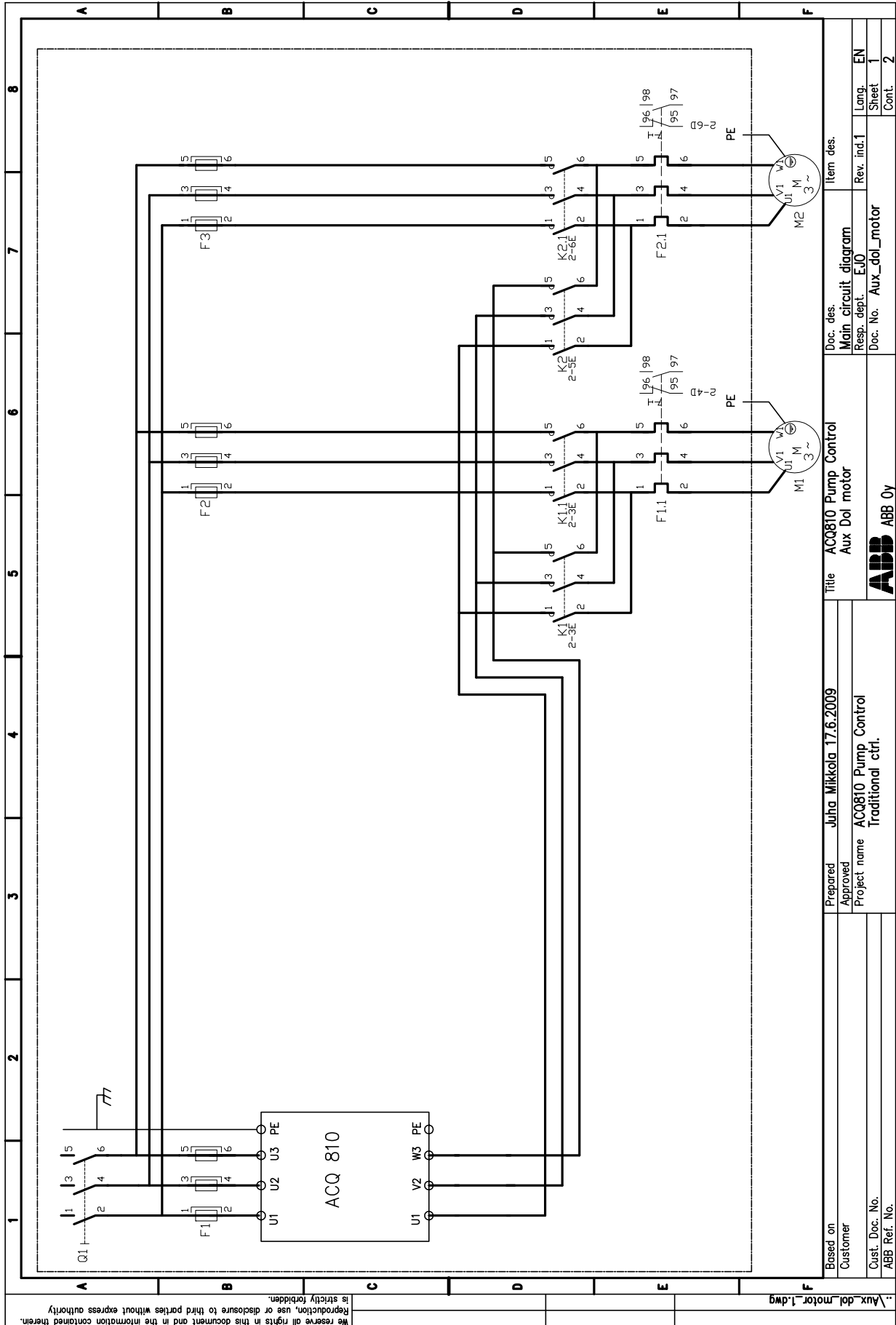

We reserve all rights in this document and in the information contained therein. Reproduction, use or disclosure to third parties without express authority is strictly forbidden.

Based on	Prepared	Title	Doc. des.	Item des.
Customer	Approved	Juha Mikkola 17.6.2009	Main circuit diagram	Main circuit diagram
Cust. Doc. No.	Project name	ACQ810 Pump Control	Resp. dept. EJO	Rev. ind.1
ABB Ref. No.	Traditional ctrl.	ACQ810 Pump Control	Doc. No. Aux_dol_motor	Rev. ind.1
		ABB ABB Oy		Lang. EN
				Sheet 1
				Cont. 2



## Level control macro

### ■ Description and typical application

The level control macro is designed for controlling a station of 1 to 8 pumps that is used for either emptying or filling a container.

The level control functionality is activated by setting parameter [79.01 Level mode](#) to *Emptying* or *Filling* and selecting external control location EXT2. In addition, parameter [12.05 Ext2 ctrl mode](#) must have the setting *PID* when level control is used. The start levels for the pumps (as well as the alarm levels) are set by parameters in group [79 Level control](#).

At any given time, one of the drives acts as master. The master status can be rotated between the drives using the Autochange function, or one drive can be fixed to master status. The start/stop level settings of the master are the ones in effect.

The following drawing represents a station with three submersible pumps in emptying mode. Each pump has a pre-defined start level, and more pumps are started as the level in the container rises. The level sensor is connected to an analog input that is selected as the process actual value in parameter group [28 Procact sel](#).

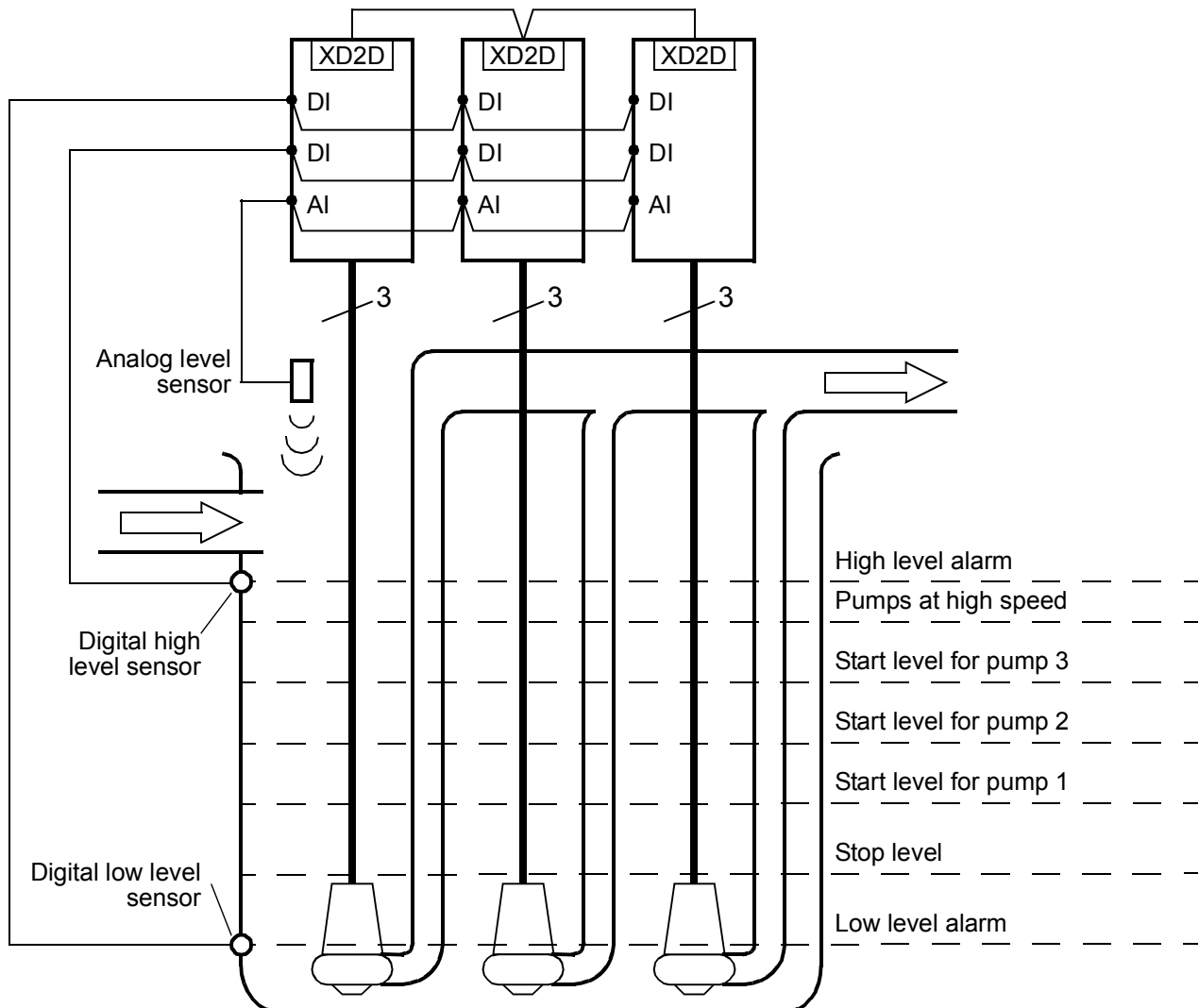

## ■ Default settings

Below is a listing of default parameter values that differ from those listed in chapter [Additional parameter data](#) (page 307).

Parameter		Level control macro default	
No.	Name	Single pump	Multiple pumps
16.20	<i>Macro Read Only</i>	<i>Level ctrl</i>	<i>Multi level</i>
76.01	<i>Enable MF comm</i>	<i>No</i>	<i>Yes</i>
77.01	<i>Sleep mode sel</i>	<i>Not used</i>	<i>Not used</i>
79.01	<i>Level mode</i>	<i>Emptying</i>	<i>Emptying</i>

■ Default control connections for the Level control macro

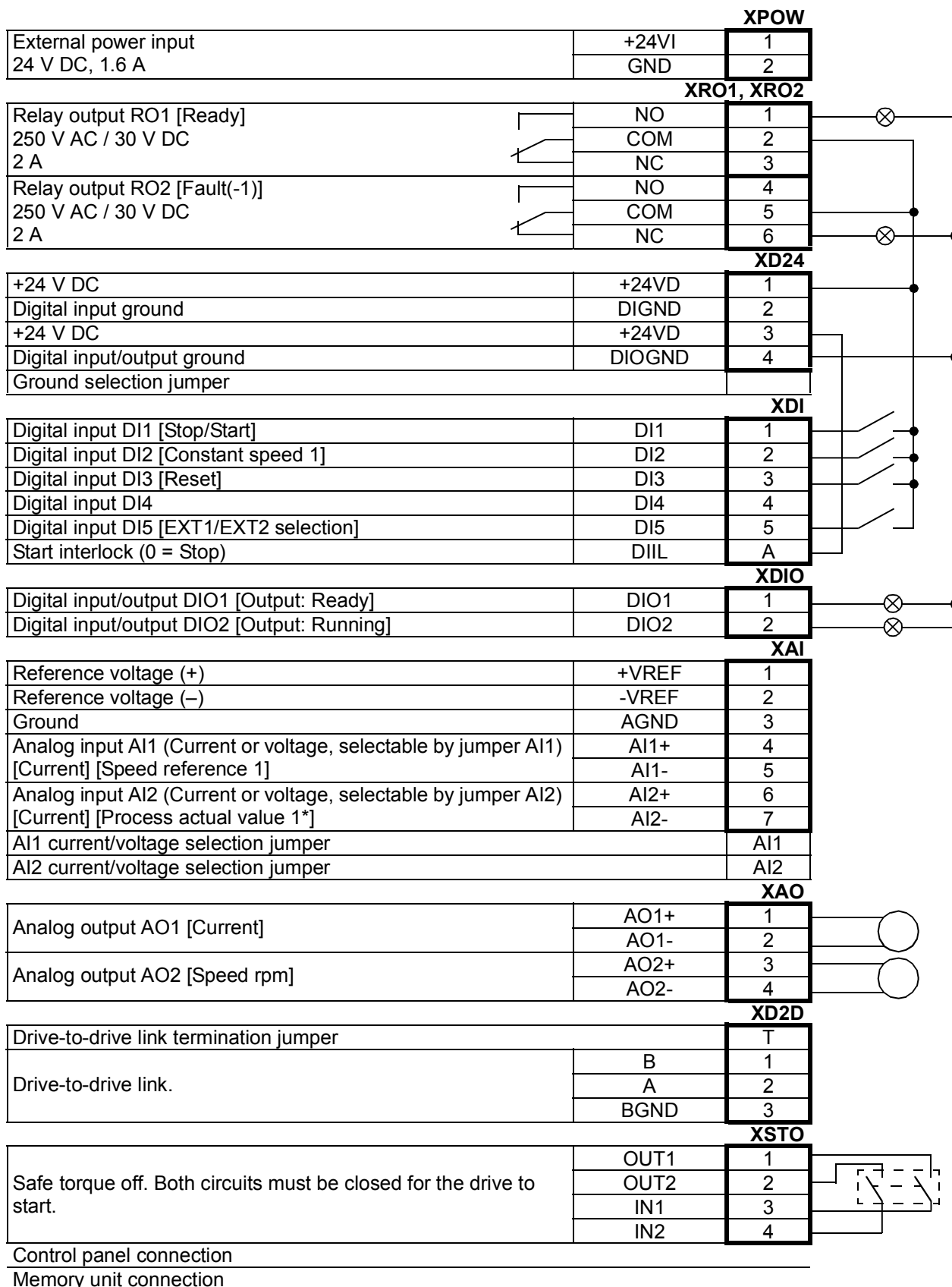

## Multipump control macro

### ■ Description and typical application

This macro is suitable for pump stations that consist of multiple pumps, each controlled by a separate drive.

The configuration supports redundancy so that in case of a pump failure or maintenance action on one drive, the remaining drives continue operation. The drives communicate with each other through the drive-to-drive (D2D) link. It is possible to distribute two analog and five digital signals from a specific drive to the other drives via the drive-to-drive link (see parameters [76.11](#)...[76.16](#)).

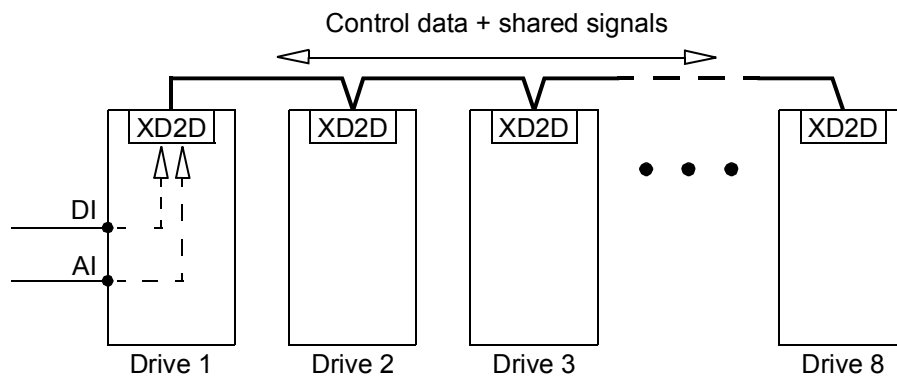

The multipump macro has three modes selectable by parameter.

- In master-regulated operation, when the load increases, the master's speed increases. After the master has reached full speed, other drives are started one by one. Depending on a parameter setting, the master status is retained by the first drive, or passed on to the drive that was started last.
- Follower drives are run either at a pre-set speed (i.e. at the optimal operating point of the pump) or at the same speed as the master. In both these modes, drives can be prioritized so that the one with the highest priority is the first to be started.
- In direct follower operation, all drives run in synchronization with the master. This mode can be used in time-critical applications or for testing of the pump installation.

**■ Default settings**

Below is a listing of default parameter values that differ from those listed in chapter [Additional parameter data](#) (page 307).

Parameter		Multipump control macro default
No.	Name	
16.20	<i>Macro Read Only</i>	<i>Multi pump</i>
75.01	<i>Operation mode</i>	<i>Multipump</i>
76.01	<i>Enable MF comm</i>	<i>Yes</i>



■ Default control connections for the Multipump control macro

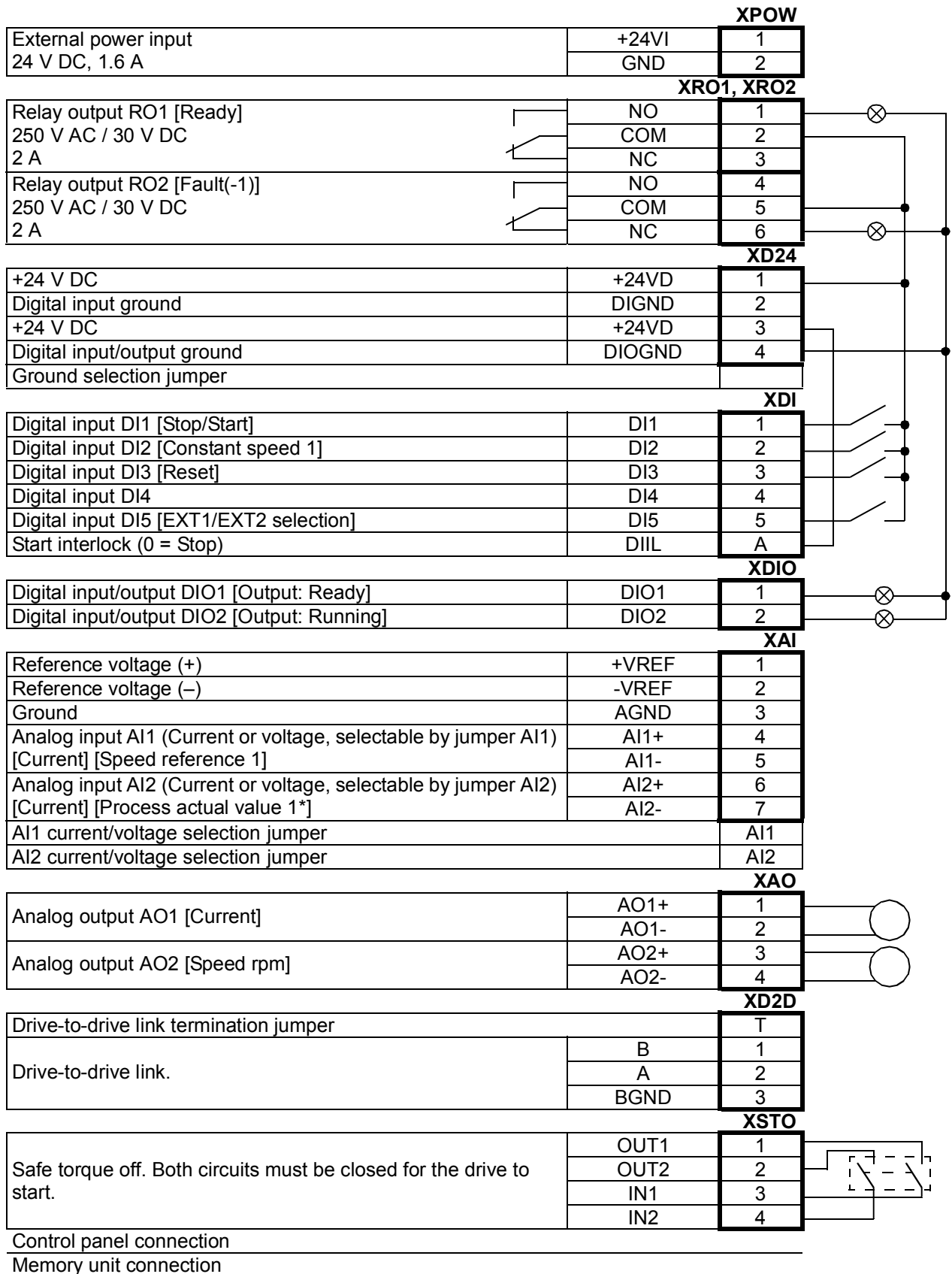

\*See [Pressure sensor connection examples](#) on page 114.

## Pressure sensor connection examples

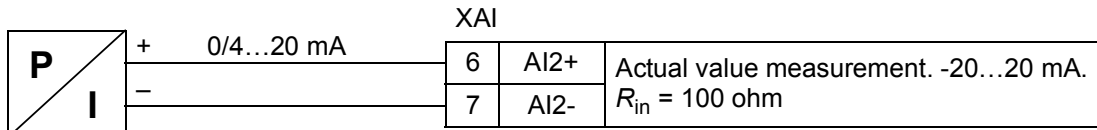

**Note:** The sensor must be powered externally.

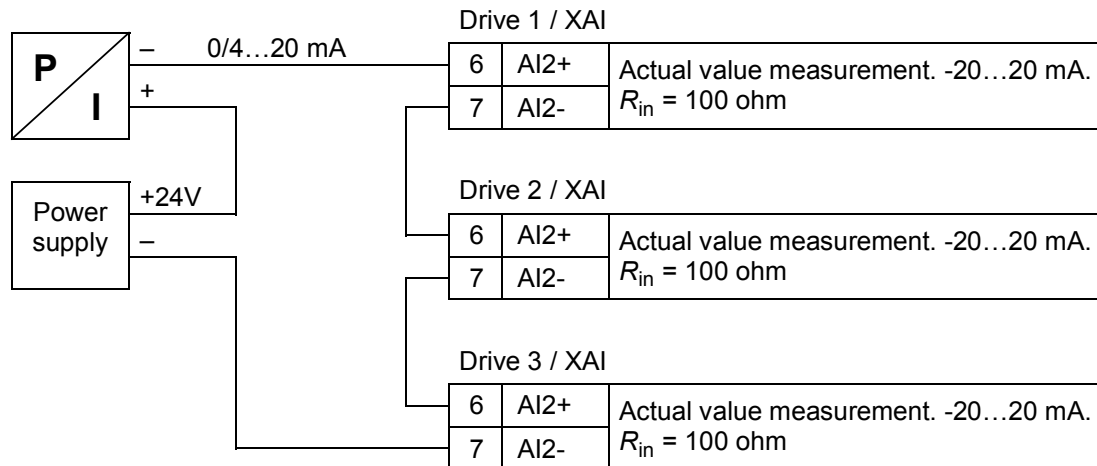
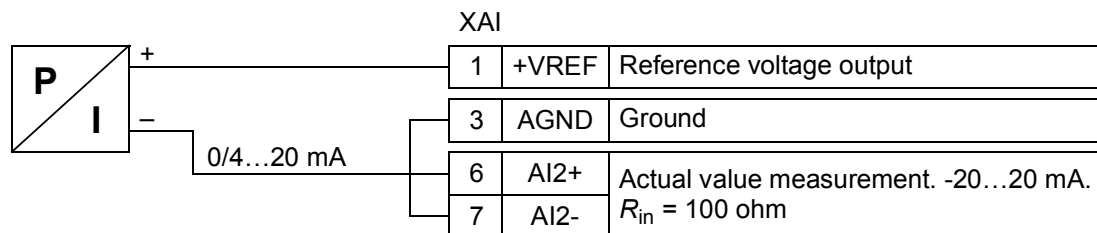
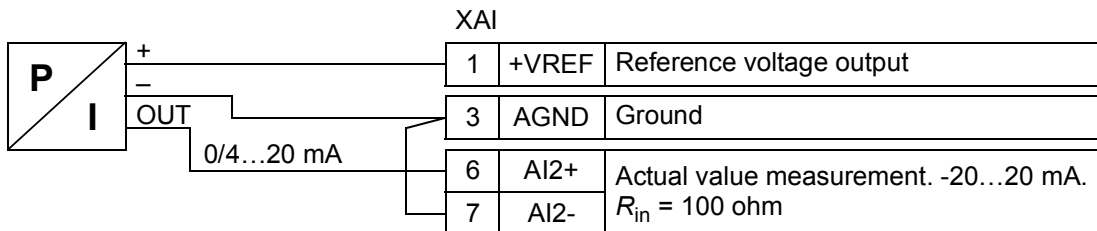



# Parameters

---

## What this chapter contains

The chapter describes the parameters, including actual signals, of the control program.

**Note:** In case only part of the parameters are visible, set parameter [16.21 Menu selection](#) to *Full*.

## Terms and abbreviations

Term	Definition
Actual signal	Type of parameter that is the result of a measurement or calculation by the drive. Actual signals can be monitored, but not adjusted, by the user. Parameter groups 1...9 typically contain actual signals.
Bit pointer setting	A parameter setting that points to the value of a bit in another parameter (usually an actual signal), or that can be fixed to 0 (FALSE) or 1 (TRUE). When adjusting a bit pointer setting on the optional control panel, "Const" is selected in order to fix the value to 0 (displayed as "C.False") or 1 ("C.True"). "Pointer" is selected to define a source from another parameter. A pointer value is given in the format <b>P.xx.yy.zz</b> , where <b>xx</b> = parameter group, <b>yy</b> = parameter index, <b>zz</b> = bit number. Pointing to a nonexistent bit will be interpreted as 0 (FALSE). In addition to the "Const" and "Pointer" selections, bit pointer settings may also have other pre-selected settings.
FbEq	Fieldbus equivalent. The scaling between the value shown on the panel and the integer used in serial communication.
p.u.	Per unit
Value pointer setting	A parameter that points to the value of another actual signal or parameter. A pointer value is given in the format <b>P.xx.yy</b> , where <b>xx</b> = parameter group, <b>yy</b> = parameter index.

---

## Summary of parameter groups

Group	Contents	Page
<a href="#">01 Actual values</a>	Basic signals for monitoring of the drive.	<a href="#">118</a>
<a href="#">02 I/O values</a>	Input and output states and values; control and status words.	<a href="#">119</a>
<a href="#">03 Control values</a>	Speed and torque control values.	<a href="#">129</a>
<a href="#">04 Appl values</a>	Process and counter values.	<a href="#">129</a>
<a href="#">05 Pump values</a>	Pump station actual values.	<a href="#">130</a>
<a href="#">06 Drive status</a>	Drive status words.	<a href="#">133</a>
<a href="#">08 Alarms &amp; faults</a>	Alarm and fault information.	<a href="#">138</a>
<a href="#">09 System info</a>	Drive type, program revision and option slot occupation information.	<a href="#">143</a>
<a href="#">10 Start/stop/dir</a>	Start/stop/direction, run enable and emergency stop source selections; start inhibit and start interlock configuration.	<a href="#">144</a>
<a href="#">11 Start/stop mode</a>	Start and stop modes; magnetization settings; DC hold configuration.	<a href="#">150</a>
<a href="#">12 Operating mode</a>	Selection of external control location and EXT2 operating mode.	<a href="#">152</a>
<a href="#">13 Analogue inputs</a>	Analog input signal processing.	<a href="#">153</a>
<a href="#">14 Digital I/O</a>	Configuration of digital input/outputs, relay outputs, the frequency input, and the frequency output.	<a href="#">159</a>
<a href="#">15 Analogue outputs</a>	Selection and processing of actual signals to be indicated through the analog outputs.	<a href="#">170</a>
<a href="#">16 System</a>	Local lock and parameter lock settings; parameter restore; user parameter set load/save; parameter change log reset; parameter list settings; unit of power selection; application macro display.	<a href="#">176</a>
<a href="#">19 Speed calculation</a>	Speed scaling, feedback and supervision settings.	<a href="#">180</a>
<a href="#">20 Limits</a>	Drive operation limits.	<a href="#">182</a>
<a href="#">21 Speed ref</a>	Speed reference source selection and processing.	<a href="#">184</a>
<a href="#">22 Speed ref ramp</a>	Speed reference and emergency stop (OFF3) ramp settings.	<a href="#">186</a>
<a href="#">23 Speed ctrl</a>	Speed controller settings.	<a href="#">188</a>
<a href="#">25 Critical speed</a>	Configuration of critical speeds (or ranges of speed) that are avoided due to, for example, mechanical resonance problems.	<a href="#">196</a>
<a href="#">26 Constant speeds</a>	Constant speed selection and values.	<a href="#">197</a>
<a href="#">27 Process PID</a>	Configuration of process PID control.	<a href="#">199</a>
<a href="#">28 Procact sel</a>	Process actual value (feedback) settings.	<a href="#">203</a>
<a href="#">29 Setpoint sel</a>	Process setpoint (reference) settings.	<a href="#">205</a>
<a href="#">30 Fault functions</a>	Configuration of behavior of the drive upon various fault situations.	<a href="#">207</a>
<a href="#">31 Motor therm prot</a>	Motor temperature measurement and thermal protection settings.	<a href="#">209</a>
<a href="#">32 Automatic reset</a>	Configuration of conditions for automatic fault resets.	<a href="#">214</a>
<a href="#">33 Supervision</a>	Configuration of signal supervision.	<a href="#">214</a>
<a href="#">34 User load curve</a>	Configuration of user load curve.	<a href="#">218</a>
<a href="#">35 Process variable</a>	Selection and modification of process variables for display as parameters 04.06 ... 04.08.	<a href="#">220</a>
<a href="#">36 Timed functions</a>	Configuration of timers.	<a href="#">226</a>
<a href="#">38 Flux ref</a>	Flux reference and U/f curve settings.	<a href="#">231</a>
<a href="#">40 Motor control</a>	Motor control settings such as performance/noise optimization, slip gain, voltage reserve and IR compensation.	<a href="#">232</a>

<b>Group</b>	<b>Contents</b>	<b>Page</b>
<a href="#">44 Maintenance</a>	Maintenance counter configuration.	<a href="#">234</a>
<a href="#">45 Energy optimising</a>	Energy optimization settings.	<a href="#">240</a>
<a href="#">47 Voltage ctrl</a>	Overvoltage and undervoltage control settings.	<a href="#">241</a>
<a href="#">49 Data storage</a>	Data storage parameters reserved for the user.	<a href="#">242</a>
<a href="#">50 Fieldbus</a>	Settings for configuration of communication via a fieldbus adapter.	<a href="#">242</a>
<a href="#">51 FBA settings</a>	Fieldbus adapter-specific settings.	<a href="#">245</a>
<a href="#">52 FBA data in</a>	Selection of data to be transferred from drive to fieldbus controller via fieldbus adapter.	<a href="#">246</a>
<a href="#">53 FBA data out</a>	Selection of data to be transferred from fieldbus controller to drive via fieldbus adapter.	<a href="#">247</a>
<a href="#">56 Panel display</a>	Selection of signals to be displayed on control panel.	<a href="#">247</a>
<a href="#">58 Embedded Modbus</a>	Configuration parameters for the embedded fieldbus (EFB) interface.	<a href="#">249</a>
<a href="#">64 Load analyzer</a>	Peak value and amplitude logger settings.	<a href="#">253</a>
<a href="#">75 Pump logic</a>	Configuration settings for the pump station.	<a href="#">256</a>
<a href="#">76 MF communication</a>	Communication configuration for applications consisting of multiple pumps with dedicated drives.	<a href="#">268</a>
<a href="#">77 Pump sleep</a>	Sleep function settings.	<a href="#">271</a>
<a href="#">78 Pump autochange</a>	Pump Autochange and interlock settings.	<a href="#">274</a>
<a href="#">79 Level control</a>	Settings for level control applications.	<a href="#">279</a>
<a href="#">80 Flow calculation</a>	Settings for the flow calculation function.	<a href="#">284</a>
<a href="#">81 Pump protection</a>	Settings for pump protection functions.	<a href="#">288</a>
<a href="#">82 Pump cleaning</a>	Settings for the pump cleaning sequence.	<a href="#">296</a>
<a href="#">83 Energy monitoring</a>	Energy consumption monitoring settings.	<a href="#">299</a>
<a href="#">94 Ext IO conf</a>	I/O extension configuration.	<a href="#">300</a>
<a href="#">95 Hw configuration</a>	Diverse hardware-related settings.	<a href="#">300</a>
<a href="#">97 User motor par</a>	Motor values supplied by the user that are used in the motor model.	<a href="#">300</a>
<a href="#">99 Start-up data</a>	Language selection, motor configuration and ID run settings.	<a href="#">301</a>

## Parameter listing

No.	Name/Value	Description	FbEq
<b>01 Actual values</b>		Basic signals for monitoring of the drive.	
01.01	Motor speed rpm	Filtered, estimated motor speed in rpm. The filter time constant can be adjusted using parameter <a href="#">19.03 MotorSpeed filt.</a>	100 = 1 rpm
01.02	Motor speed %	Actual speed in percent of the motor synchronous speed.	100 = 1%
01.03	Output frequency	Estimated drive output frequency in Hz.	100 = 1 Hz
01.04	Motor current	Measured motor current in A.	100 = 1 A
01.05	Motor current %	Motor current in percent of the nominal motor current.	10 = 1%
01.06	Motor torque	Motor torque in percent of the nominal motor torque. See also parameter <a href="#">01.29 Torq nom scale.</a>	10 = 1%
01.07	Dc-voltage	Measured intermediate circuit voltage.	100 = 1 V
01.14	Motor speed est	Estimated motor speed in rpm.	100 = 1 rpm
01.15	Temp inverter	Estimated IGBT temperature in percent of fault limit.	10 = 1%
01.17	Motor temp1	Measured temperature of motor 1 in degrees Celsius when a KTY sensor is used. (With a PTC sensor, the value is always 0.)	10 = 1 °C
01.18	Motor temp2	Measured temperature of motor 2 in degrees Celsius when a KTY sensor is used. (With a PTC sensor, the value is always 0.)	10 = 1 °C
01.19	Used supply volt	Either the user-given supply voltage (parameter <a href="#">47.04 Supply voltage</a> ), or, if auto-identification is enabled by parameter <a href="#">47.03 Sup volt auto Id</a> , the automatically determined supply voltage.	10 = 1 V
01.21	Cpu usage	Microprocessor load in percent.	1 = 1%
01.22	Power inu out	Drive output power in kW or hp, depending on setting of parameter <a href="#">16.17 Power unit</a> . Filtered using 100 ms low-pass filtering.	100 = 1 kW or hp
01.23	Motor power	Measured motor shaft power in kW or hp, depending on setting of parameter <a href="#">16.17 Power unit</a> . Filtered using 100 ms low-pass filtering.	100 = 1 kW or hp
01.24	kWh inverter	Amount of energy that has passed through the drive (in either direction) in kilowatt-hours. Can be reset by entering a 0 using the DriveStudio PC tool.	1 = 1 kWh
01.25	kWh supply	Amount of energy that the drive has taken from the AC supply in kilowatt-hours. Can be reset by entering a 0 using the DriveStudio PC tool.	1 = 1 kWh
01.26	On-time counter	On-time counter. The counter runs when the drive is powered. Can be reset by entering a 0 using the DriveStudio PC tool.	1 = 1 h
01.27	Run-time counter	Motor run-time counter. The counter runs when the inverter modulates. Can be reset by entering a 0 using the DriveStudio PC tool. <b>Note:</b> The drive logic uses this value for equalization of pump running duties. See section <a href="#">Autochange</a> (page 64).	1 = 1 h
01.28	Fan on-time	Running time of the drive cooling fan. Can be reset by entering a 0 using the DriveStudio PC tool.	1 = 1 h

No.	Name/Value	Description	FbEq																
01.29	Torq nom scale	Nominal torque which corresponds to 100%. <b>Note:</b> This value is copied from parameter <a href="#">99.12 Mot nom torque</a> if entered. Otherwise the value is calculated.	1000 = 1 N•m																
01.30	Polepairs	Calculated number of pole pairs in the motor.	1 = 1																
01.31	Mech time const	Mechanical time constant of the drive and the machinery as determined by the speed controller autotune function. See parameter group <a href="#">23 Speed ctrl</a> on page <a href="#">188</a> .	1000 = 1 s																
01.32	Temp phase A	Measured temperature of phase U power stage in percent of fault limit.	10 = 1%																
01.33	Temp phase B	Measured temperature of phase V power stage in percent of fault limit.	10 = 1%																
01.34	Temp phase C	Measured temperature of phase W power stage in percent of fault limit.	10 = 1%																
01.35	Saved energy	Energy saved in kWh compared to direct-on-line motor connection. <b>Note:</b> This value is derived from subtracting the drive's energy consumed from the direct-on-line consumption calculated on the basis of parameter <a href="#">45.08 Pump ref power</a> . As such, the accuracy of this signal is dependent on the accuracy of the direct-on-line power estimate entered in that parameter. See parameter group <a href="#">45 Energy optimising</a> on page <a href="#">240</a> .	1 = 1 kWh																
01.36	Saved amount	Monetary savings compared to direct-on-line motor connection. This value is a multiplication of parameters <a href="#">01.35 Saved energy</a> and <a href="#">45.02 Energy tariff1</a> . See parameter group <a href="#">45 Energy optimising</a> on page <a href="#">240</a> .	100 = 1																
01.37	Saved CO2	Reduction in CO <sub>2</sub> emissions in metric tons compared to direct-on-line motor connection. This value is calculated by multiplying the saved energy in MWh by <a href="#">45.07 CO2 Conv factor</a> (default 0.5 tn/MWh). See parameter group <a href="#">45 Energy optimising</a> on page <a href="#">240</a> .	10 = 1 metric ton																
01.38	Temp int board	Measured temperature of the interface board in degrees Celsius.	10 = 1 °C																
01.39	Output voltage	Calculated motor voltage.	1 = 1 V																
01.40	Speed filt	Filtered result from <a href="#">01.01 Motor speed rpm</a> . The filter time is set with parameter <a href="#">56.08 Speed filt time</a> . This signal is not used in motor control.	100 = 1 rpm																
01.41	Torque filt	Filtered result from <a href="#">01.06 Motor torque</a> . The filter time is set with parameter <a href="#">56.09 Torque filt time</a> . This signal is not used in motor control.	10 = 1%																
01.42	Fan start count	Number of times the drive cooling fan has been started.	1 = 1																
<b>02 I/O values</b>		Input and output states and values; control and status words.																	
02.01	DI status	Status of digital inputs DI1...DI6 and DIIL. <table border="1" data-bbox="561 1823 1260 1901"> <thead> <tr> <th>Bit</th> <th>6</th> <th>5</th> <th>4</th> <th>3</th> <th>2</th> <th>1</th> <th>0</th> </tr> </thead> <tbody> <tr> <td>Input</td> <td>DI6</td> <td>DIIL</td> <td>DI5</td> <td>DI4</td> <td>DI3</td> <td>DI2</td> <td>DI1</td> </tr> </tbody> </table> <b>Example:</b> 0100001 = DIIL is on, DI1 is on, DI2...DI6 are off. <b>Note:</b> DI6 is available only with an FIO I/O extension module. See section <a href="#">Programmable I/O extensions</a> on page <a href="#">71</a> .	Bit	6	5	4	3	2	1	0	Input	DI6	DIIL	DI5	DI4	DI3	DI2	DI1	-
Bit	6	5	4	3	2	1	0												
Input	DI6	DIIL	DI5	DI4	DI3	DI2	DI1												

## 120 Parameters

No.	Name/Value	Description	FbEq
02.02	RO status	Status of relay outputs RO6...RO1. <b>Example:</b> 000011 = RO1 and RO2 are energized, RO3...RO6 are de-energized. <b>Note:</b> RO3...RO6 are available only with an FIO I/O extension module. See section <a href="#">Programmable I/O extensions</a> on page 71.	-
02.03	DIO status	Status of digital input/outputs DIO6...DIO1. <b>Example:</b> 001001 = DIO1 and DIO4 are on, remainder are off. <b>Note:</b> DIO3...DIO6 are available only with an FIO I/O extension module. See section <a href="#">Programmable I/O extensions</a> on page 71.	-
02.04	AI1	Value of analog input AI1 in V or mA. Input type is selected with a jumper on the JCU Control Unit.	1000 = 1 unit
02.05	AI1 scaled	Scaled value of analog input AI1. See parameters <a href="#">13.04 AI1 max scale</a> and <a href="#">13.05 AI1 min scale</a> .	1000 = 1 unit
02.06	AI2	Value of analog input AI2 in V or mA. Input type is selected with a jumper on the JCU Control Unit.	1000 = 1 unit
02.07	AI2 scaled	Scaled value of analog input AI2. See parameters <a href="#">13.09 AI2 max scale</a> and <a href="#">13.10 AI2 min scale</a> .	1000 = 1 unit
02.08	AI3	Value of analog input AI3 in V or mA. For input type information, see the extension module manual.	1000 = 1 unit
02.09	AI3 scaled	Scaled value of analog input AI3. See parameters <a href="#">13.14 AI3 max scale</a> and <a href="#">13.15 AI3 min scale</a> .	1000 = 1 unit
02.10	AI4	Value of analog input AI4 in V or mA. For input type information, see the extension module manual.	1000 = 1 unit
02.11	AI4 scaled	Scaled value of analog input AI4. See parameters <a href="#">13.19 AI4 max scale</a> and <a href="#">13.20 AI4 min scale</a> .	1000 = 1 unit
02.12	AI5	Value of analog input AI5 in V or mA. For input type information, see the extension module manual.	1000 = 1 unit
02.13	AI5 scaled	Scaled value of analog input AI5. See parameters <a href="#">13.24 AI5 max scale</a> and <a href="#">13.25 AI5 min scale</a> .	1000 = 1 unit
02.16	AO1	Value of analog output AO1 in mA.	1000 = 1 mA
02.17	AO2	Value of analog output AO2 in mA.	1000 = 1 mA
02.18	AO3	Value of analog output AO3 in mA.	1000 = 1 mA
02.19	AO4	Value of analog output AO4 in mA.	1000 = 1 mA
02.20	Freq in	Scaled value of DIO1 when it is used as a frequency input. See parameters <a href="#">14.02 DIO1 conf</a> and <a href="#">14.57 Freq in max</a> .	1000 = 1
02.21	Freq out	Frequency output value of DIO2 when it is used as a frequency output (parameter <a href="#">14.06</a> is set to <a href="#">Freq output</a> ).	1000 = 1 Hz



No.	Name/Value	Description	FbEq		
02.22	FBA main cw	Internal Control Word of the drive received through the fieldbus adapter interface. See also chapter <a href="#">Control through a fieldbus adapter</a> on page 383. Log. = Logical combination (i.e. Bit AND/OR Selection parameter); Par. = Selection parameter.	-		
Bit	Name	Value	Information	Log.	Par.
0*	Stop	1	Stop according to the stop mode selected by par. <a href="#">11.03 Stop mode</a> or according to the requested stop mode (bits 2...6). <b>Note:</b> Simultaneous stop and start commands result in a stop command.	OR	<a href="#">10.01</a> , <a href="#">10.04</a>
		0	No action.		
1	Start	1	Start. <b>Note:</b> Simultaneous stop and start commands result in a stop command.	OR	<a href="#">10.01</a> , <a href="#">10.04</a>
		0	No action.		
2*	StpMode em off	1	Emergency OFF2 (bit 0 must be 1). Drive is stopped by cutting off motor power supply (the motor coasts to stop). The drive will restart only with the next rising edge of the start signal when the run enable signal is on.	AND	-
		0	No action.		
3*	StpMode em stop	1	Emergency stop OFF3 (bit 0 must be 1). Stop within time defined by <a href="#">22.12 Em stop time</a> .	AND	<a href="#">10.13</a>
		0	No action.		
4*	StpMode off1	1	Emergency stop OFF1 (bit 0 must be 1). Stop along the currently active deceleration ramp.	AND	<a href="#">10.15</a>
		0	No action.		
5*	StpMode ramp	1	Stop along the currently active deceleration ramp.	-	<a href="#">11.03</a>
		0	No action.		
6*	StpMode coast	1	Coast to stop.	-	<a href="#">11.03</a>
		0	No action.		
7	Run enable	1	Activate run enable.	AND	<a href="#">10.11</a>
		0	Activate run disable.		
8	Reset	0 -> 1	Fault reset if an active fault exists.	OR	<a href="#">10.10</a>
		other	No action.		
(continued)					
* If all stop mode bits (2...6) are 0, stop mode is selected by parameter <a href="#">11.03 Stop mode</a> . Coast stop (bit 6) overrides the emergency stop (bits 2/3/4). Emergency stop overrides normal ramp stop (bit 5).					

No.	Name/Value	Description	FbEq				
	<b>Bit</b>	<b>Name</b>	<b>Value</b>	<b>Information</b>	<b>Log.</b>	<b>Par.</b>	
	(continued)						
	9...10	Reserved					
	11	Remote cmd	1	Fieldbus control enabled.	-	-	
			0	Fieldbus control disabled.			
	12	Ramp out 0	1	Force output of Ramp Function Generator to zero. The drive ramps to a stop (current and DC voltage limits are in force).	-	-	
			0	No action.			
	13	Ramp hold	1	Halt ramping (Ramp Function Generator output held).	-	-	
			0	No action.			
	14	Ramp in 0	1	Force input of Ramp Function Generator to zero.	-	-	
			0	No action.			
	15	Ext1 / Ext2	1	Switch to external control location EXT2.	OR	12.01	
			0	Switch to external control location EXT1.			
	16	Req startinh	1	Activate start inhibit.	-	-	
			0	No start inhibit.			
	17	Local ctl	1	Request local control for Control Word. Used when the drive is controlled from a PC tool or panel or local fieldbus. <ul style="list-style-type: none"> <li>Local fieldbus: Transfer to fieldbus local control (control through Control Word or reference). Fieldbus steals the control.</li> <li>Panel or PC tool: Transfer to local control.</li> </ul>	-	-	
			0	Request external control.			
	18	FbLocal ref	1	Request fieldbus local control.	-	-	
			0	No fieldbus local control.			
	19...27	Reserved					
	28	CW B28	Freely programmable control bits. See parameters <a href="#">50.08...50.11</a> and the user manual of the fieldbus adapter.			-	-
	29	CW B29					
	30	CW B30					
	31	CW B31					

No.	Name/Value	Description	FbEq
02.24	FBA main sw	Internal Status word of the drive to be sent through the fieldbus adapter interface. See also chapter <a href="#">Control through a fieldbus adapter</a> on page 383.	-
Bit	Name	Value	Information
0	Ready	1	Drive is ready to receive start command.
		0	Drive is not ready.
1	Enabled	1	External run enable signal is received.
		0	No external run enable signal is received.
2	Relay running	1	Drive is modulating.
		0	Drive is not modulating.
3	Ref running	1	Normal operation is enabled. Drive is running and following given reference.
		0	Normal operation is disabled. Drive is not following given reference (for example, it is modulating during magnetization).
4	Em off (OFF2)	1	Emergency OFF2 is active.
		0	Emergency OFF2 is inactive.
5	Em stop (OFF3)	1	Emergency stop OFF3 (ramp stop) is active.
		0	Emergency stop OFF3 is inactive.
6	Ack startinh	1	Start inhibit is active.
		0	Start inhibit is inactive.
7	Alarm	1	An alarm is active. See chapter <a href="#">Fault tracing</a> on page 335
		0	No alarm is active.
8	At setpoint	1	Drive is at setpoint. Actual value equals reference value (i.e. the difference between the actual speed and speed reference is within the speed window defined by parameter <a href="#">19.10 Speed window</a> ).
		0	Drive has not reached setpoint.
(continued)			

No.	Name/Value	Description	FbEq
	<b>Bit</b>	<b>Name</b>	<b>Value</b>   <b>Information</b>
	(continued)		
9	Limit	1	Operation is limited by any of the torque limits.
		0	Operation is within the torque limits.
10	Above limit	1	Actual speed exceeds limit defined by parameter <a href="#">19.08 Above speed lim.</a>
		0	Actual speed is within the defined limits.
11	Ext2 act	1	External control location EXT2 is active.
		0	External control location EXT1 is active.
12	Local fb	1	Fieldbus local control is active.
		0	Fieldbus local control is inactive.
13	Zero speed	1	Drive speed is below limit defined by parameter <a href="#">19.06 Zero speed limit.</a>
		0	Drive has not reached zero speed limit.
14	Rev act	1	Drive is running in reverse direction.
		0	Drive is running in forward direction.
15	Reserved		
16	Fault	1	A fault is active. See chapter <a href="#">Fault tracing</a> on page <a href="#">335</a> .
		0	No fault is active.
17	Local panel	1	Local control is active, i.e. the drive is controlled from PC tool or control panel.
		0	Local control is inactive.
18...26	Reserved		
27	Request ctl	1	Control Word is requested from fieldbus.
		0	Control Word is not requested from fieldbus.
28	SW B28	Programmable control bits (unless fixed by the used profile). See parameters <a href="#">50.08...50.11</a> and the user manual of the fieldbus adapter.	
29	SW B29		
30	SW B30		
31	SW B31		
02.26	FBA main ref1	Internal and scaled reference 1 of the drive received through the fieldbus adapter interface. See parameter <a href="#">50.04 FBA ref1 modesel</a> and chapter <a href="#">Control through a fieldbus adapter</a> on page <a href="#">383</a> .	1 = 1
02.27	FBA main ref2	Internal and scaled reference 2 of the drive received through the fieldbus adapter interface. See parameter <a href="#">50.05 FBA ref2 modesel</a> and chapter <a href="#">Control through a fieldbus adapter</a> on page <a href="#">383</a> .	1 = 1
02.34	Panel ref	Reference given from the control panel. See also parameter <a href="#">56.07 Local ref unit</a> .	100 = 1 rpm 10 = 1%

No.	Name/Value	Description	FbEq		
02.36	EFB main cw	Internal Control Word of the drive received through the embedded fieldbus interface. See chapter <a href="#">Control through the embedded fieldbus interface</a> on page 355. Log. = Logical combination (i.e. Bit AND/OR Selection parameter); Par. = Selection parameter.	-		
Bit	Name	Value	Information	Log.	Par.
0*	Stop	1	Stop according to the stop mode selected by par. <a href="#">11.03 Stop mode</a> or according to the requested stop mode (bits 2...6). <b>Note:</b> Simultaneous stop and start commands result in a stop command.	OR	<a href="#">10.01</a> , <a href="#">10.04</a>
		0	No action.		
1	Start	1	Start. <b>Note:</b> Simultaneous stop and start commands result in a stop command.	OR	<a href="#">10.01</a> , <a href="#">10.04</a>
		0	No action.		
2*	StpMode em off	1	Emergency OFF2 (bit 0 must be 1). Drive is stopped by cutting off motor power supply (the motor coasts to stop). The drive will restart only with the next rising edge of the start signal when the run enable signal is on.	AND	-
		0	No action.		
3*	StpMode em stop	1	Emergency stop OFF3 (bit 0 must be 1). Stop within time defined by <a href="#">22.12 Em stop time</a> .	AND	<a href="#">10.13</a>
		0	No action.		
4*	StpMode off1	1	Emergency stop OFF1 (bit 0 must be 1). Stop along the currently active deceleration ramp.	AND	<a href="#">10.15</a>
		0	No action.		
5*	StpMode ramp	1	Stop along the currently active deceleration ramp.	-	<a href="#">11.03</a>
		0	No action.		
6*	StpMode coast	1	Coast to stop.	-	<a href="#">11.03</a>
		0	No action.		
7	Run enable	1	Activate run enable.	AND	<a href="#">10.11</a>
		0	Activate run disable.		
8	Reset	0 -> 1	Fault reset if an active fault exists.	OR	<a href="#">10.10</a>
		other	No action.		
(continued)					
* If all stop mode bits (2...6) are 0, stop mode is selected by parameter <a href="#">11.03 Stop mode</a> . Coast stop (bit 6) overrides the emergency stop (bits 2/3/4). Emergency stop overrides normal ramp stop (bit 5).					

No.	Name/Value	Description	FbEq				
	<b>Bit</b>	<b>Name</b>	<b>Value</b>	<b>Information</b>	<b>Log.</b>	<b>Par.</b>	
	(continued)						
	9...10	Reserved					
	11	Remote cmd	1	Fieldbus control enabled.	-	-	
			0	Fieldbus control disabled.			
	12	Ramp out 0	1	Force output of Ramp Function Generator to zero. The drive ramps to a stop (current and DC voltage limits are in force).	-	-	
			0	No action.			
	13	Ramp hold	1	Halt ramping (Ramp Function Generator output held).	-	-	
			0	No action.			
	14	Ramp in 0	1	Force input of Ramp Function Generator to zero.	-	-	
			0	No action.			
	15	Ext1 / Ext2	1	Switch to external control location EXT2.	OR	12.01	
			0	Switch to external control location EXT1.			
	16	Req startinh	1	Activate start inhibit.	-	-	
			0	No start inhibit.			
	17	Local ctl	1	Request local control for Control Word. Used when the drive is controlled from a PC tool or panel or local fieldbus. <ul style="list-style-type: none"> <li>Local fieldbus: Transfer to fieldbus local control (control through Control Word or reference). Fieldbus steals the control.</li> <li>Panel or PC tool: Transfer to local control.</li> </ul>	-	-	
			0	Request external control.			
	18	FbLocal ref	1	Request fieldbus local control.	-	-	
			0	No fieldbus local control.			
	19...27	Reserved					
	28	CW B28	Freely programmable control bits. See parameters <a href="#">50.08...50.11</a> .			-	-
	29	CW B29					
	30	CW B30					
	31	CW B31					

No.	Name/Value	Description	FbEq
02.37	EFB main sw	Internal Status word of the drive to be sent through the embedded fieldbus interface. See chapter <a href="#">Control through the embedded fieldbus interface</a> on page 355.	-
Bit	Name	Value	Information
0	Ready	1	Drive is ready to receive start command.
		0	Drive is not ready.
1	Enabled	1	External run enable signal is received.
		0	No external run enable signal is received.
2	Running	1	Drive is modulating.
		0	Drive is not modulating.
3	Ref running	1	Normal operation is enabled. Drive is running and following given reference.
		0	Normal operation is disabled. Drive is not following given reference (for example, it is modulating during magnetization).
4	Em off (OFF2)	1	Emergency OFF2 is active.
		0	Emergency OFF2 is inactive.
5	Em stop (OFF3)	1	Emergency stop OFF3 (ramp stop) is active.
		0	Emergency stop OFF3 is inactive.
6	Ack startinh	1	Start inhibit is active.
		0	Start inhibit is inactive.
7	Alarm	1	An alarm is active. See chapter <a href="#">Fault tracing</a> on page 335.
		0	No alarm is active.
8	At setpoint	1	Drive is at setpoint. Actual value equals reference value (i.e. the difference between the actual speed and speed reference is within the speed window defined by parameter <a href="#">19.10 Speed window</a> ).
		0	Drive has not reached setpoint.
(continued)			

No.	Name/Value	Description	FbEq	
	<b>Bit</b>	<b>Name</b>	<b>Value</b>   <b>Information</b>	
	(continued)			
9	Limit	1	Operation is limited by any of the torque limits.	
		0	Operation is within the torque limits.	
10	Above limit	1	Actual speed exceeds limit defined by parameter <a href="#">19.08 Above speed lim.</a>	
		0	Actual speed is within the defined limits.	
11	Ext2 act	1	External control location EXT2 is active.	
		0	External control location EXT1 is active.	
12	Local fb	1	Fieldbus local control is active.	
		0	Fieldbus local control is inactive.	
13	Zero speed	1	Drive speed is below limit defined by parameter <a href="#">19.06 Zero speed limit.</a>	
		0	Drive has not reached zero speed limit.	
14	Rev act	1	Drive is running in reverse direction.	
		0	Drive is running in forward direction.	
15	Reserved			
16	Fault	1	A fault is active. See chapter <a href="#">Fault tracing</a> on page <a href="#">335</a> .	
		0	No fault is active.	
17	Local panel	1	Local control is active, i.e. the drive is controlled from PC tool or control panel.	
		0	Local control is inactive.	
18...26	Reserved			
27	Request ctl	1	Control Word is requested from fieldbus.	
		0	Control Word is not requested from fieldbus.	
28	SW B28	Programmable control bits (unless fixed by the used profile). See parameters <a href="#">50.08...50.11</a> .		
29	SW B29			
30	SW B30			
31	SW B31			
02.38	EFB main ref1	Internal and scaled reference 1 of the drive received through the embedded fieldbus interface. See parameter <a href="#">50.04 FBA ref1 modesel</a> and chapter <a href="#">Control through the embedded fieldbus interface</a> on page <a href="#">355</a> .	-	
02.39	EFB main ref2	Internal and scaled reference 2 of the drive received through the embedded fieldbus interface. See parameter <a href="#">50.05 FBA ref2 modesel</a> and chapter <a href="#">Control through the embedded fieldbus interface</a> on page <a href="#">355</a> .	--	
02.40	FBA setpoint	Target parameter for writing the setpoint from the fieldbus. The unit and scaling are defined by parameters <a href="#">28.06 Act unit sel</a> and <a href="#">28.07 Act FBA scaling</a> respectively.	-	
02.41	FBA act val	Target parameter for writing a feedback value from the fieldbus. The unit and scaling are defined by parameters <a href="#">28.06 Act unit sel</a> and <a href="#">28.07 Act FBA scaling</a> respectively.	-	
02.42	Shared DI	Status of shared digital inputs received through the drive-to-drive link. <b>Example:</b> 00000001 = DI1 is on, DI2...DI5 are off. See parameters <a href="#">76.11...76.16</a> .	-	
02.43	Shared signal 1	Shows the value of shared signal 1 as received through the drive-to-drive link. See parameters <a href="#">76.11...76.16</a> .	-	
02.44	Shared signal 2	Shows the value of shared signal 2 as received through the drive-to-drive link. See parameters <a href="#">76.11...76.16</a> .	-	



No.	Name/Value	Description	FbEq
<b>03 Control values</b>		Speed and torque control values.	
03.03	SpeedRef unramp	Used speed reference ramp input in rpm.	100 = 1 rpm
03.05	SpeedRef ramped	Ramped and shaped speed reference in rpm.	100 = 1 rpm
03.06	SpeedRef used	Used speed reference in rpm (reference before speed error calculation).	100 = 1 rpm
03.07	Speed error filt	Filtered speed error value in rpm.	100 = 1 rpm
03.08	Acc comp torq	Output of the acceleration compensation (torque in percent).	10 = 1%
03.09	Torq ref sp ctrl	Limited speed controller output torque in percent.	10 = 1%
03.13	Torq ref to TC	Torque reference in percent for the torque control.	10 = 1%
03.14	Torq ref used	Torque reference after frequency, voltage and torque limiters. 100% corresponds to the motor nominal torque.	10 = 1%
03.17	Flux actual	Actual flux reference in percent.	1 = 1%
03.20	Max speed ref	Maximum speed reference.	100 = 1 rpm
03.21	Min speed ref	Minimum speed reference.	100 = 1 rpm
<b>04 Appl values</b>		Process and counter values.	
04.01	Act val	Final actual value after selection (see parameter group <a href="#">28 Procact sel</a> ). The unit and scaling are defined by parameters <a href="#">28.06 Act unit sel</a> and <a href="#">28.07 Act FBA scaling</a> respectively. See also parameters <a href="#">04.20...04.22</a> .	-
04.02	Setpoint	Final setpoint (reference) value after selection (see parameter group <a href="#">29 Setpoint sel</a> ). The unit and scaling are defined by parameters <a href="#">28.06 Act unit sel</a> and <a href="#">28.07 Act FBA scaling</a> respectively. See also parameters <a href="#">04.23...04.25</a> .	-
04.04	Process PID err	Process PID error, i.e. difference between PID setpoint and actual value.	10 = 1%
04.05	Process PID out	Output of the process PID controller.	10 = 1%
04.06	Process var1	Process variable 1. See parameter group <a href="#">35 Process variable</a> .	1000 = 1%
04.07	Process var2	Process variable 2. See parameter group <a href="#">35 Process variable</a> .	1000 = 1%
04.08	Process var3	Process variable 3. See parameter group <a href="#">35 Process variable</a> .	1000 = 1%
04.09	Counter ontime1	Reading of on-time counter 1. See parameter <a href="#">44.01 Ontime1 func</a> . Can be reset by entering a 0 using the DriveStudio PC tool.	1 = 1 s
04.10	Counter ontime2	Reading of on-time counter 2. See parameter group <a href="#">44.05 Ontime2 func</a> . Can be reset by entering a 0 using the DriveStudio PC tool.	1 = 1 s
04.11	Counter edge1	Reading of rising edge counter 1. See parameter group <a href="#">44.09 Edge count1 func</a> . Can be reset by entering a 0 using the DriveStudio PC tool.	1 = 1
04.12	Counter edge2	Reading of rising edge counter 2. See parameter group <a href="#">44.14 Edge count2 func</a> . Can be reset by entering a 0 using the DriveStudio PC tool.	1 = 1

## 130 Parameters

No.	Name/Value	Description	FbEq
04.13	Counter value1	Reading of value counter 1. See parameter group <a href="#">44.19 Val count1 func</a> . Can be reset by entering a 0 using the DriveStudio PC tool.	1 = 1
04.14	Counter value2	Reading of value counter 2. See parameter group <a href="#">44.24 Val count2 func</a> . Can be reset by entering a 0 using the DriveStudio PC tool.	1 = 1
04.20	Act val 1 out	Actual value 1 (selected by parameter <a href="#">28.02 Act val 1 src</a> ).	100 = 1 unit
04.21	Act val 2 out	Actual value 2 (selected by parameter <a href="#">28.03 Act val 2 src</a> ).	100 = 1 unit
04.22	Act val %	Final actual value in %.	100 = 1%
04.23	Setpoint val 1	Setpoint 1 (selected by parameter <a href="#">29.02 Setpoint 1 src</a> ).	100 = 1 unit
04.24	Setpoint val 2	Setpoint 2 (selected by parameter <a href="#">29.03 Setpoint 2 src</a> ).	100 = 1 unit
04.25	Setpoint val %	Final setpoint in %.	100 = 1%
04.26	Wake up level	Final calculated wake-up level. See the selections of parameter <a href="#">77.08 Wake up mode sel</a> .	100 = 1
04.27	Shared source	Node number of the drive that is currently the source of shared signals. See parameters <a href="#">76.11...76.16</a> .	1 = 1
04.28	Pump runtime	Pump run-time counter. The counter runs when the drive is running (started). Can be reset using parameter <a href="#">78.14 Runtime change</a> .	1 = 1 h
04.29	Trad 1 runtime	Pump 1 run-time counter (for traditional control – see page <a href="#">100</a> ). Can be reset using parameter <a href="#">78.14 Runtime change</a> .	1 = 1 h
04.30	Trad 2 runtime	Pump 2 run-time counter (for traditional control – see page <a href="#">100</a> ). Can be reset using parameter <a href="#">78.14 Runtime change</a> .	1 = 1 h
04.31	Trad 3 runtime	Pump 3 run-time counter (for traditional control – see page <a href="#">100</a> ). Can be reset using parameter <a href="#">78.14 Runtime change</a> .	1 = 1 h
04.32	Trad 4 runtime	Pump 4 run-time counter (for traditional control – see page <a href="#">100</a> ). Can be reset using parameter <a href="#">78.14 Runtime change</a> .	1 = 1 h
04.33	Trad 5 runtime	Pump 5 run-time counter (for traditional control – see page <a href="#">100</a> ). Can be reset using parameter <a href="#">78.14 Runtime change</a> .	1 = 1 h
04.34	Trad 6 runtime	Pump 6 run-time counter (for traditional control – see page <a href="#">100</a> ). Can be reset using parameter <a href="#">78.14 Runtime change</a> .	1 = 1 h
04.35	Trad 7 runtime	Pump 7 run-time counter (for traditional control – see page <a href="#">100</a> ). Can be reset using parameter <a href="#">78.14 Runtime change</a> .	1 = 1 h
04.36	Trad 8 runtime	Pump 8 run-time counter (for traditional control – see page <a href="#">100</a> ). Can be reset using parameter <a href="#">78.14 Runtime change</a> .	1 = 1 h
<b>05 Pump values</b>		Pump station actual values.	
05.01	MF status	State of drive in a multipump configuration (several drives connected by the drive-to-drive link).	
	No	Drive-to-drive communication is not active.	0
	Standby	The drive is ready to start and waiting for a start command from the master.	1
	Master	The drive is running and currently the master.	2
	Follower	The drive is running and currently a follower.	3

No.	Name/Value	Description	FbEq																	
05.02	Trad pump cmd	Pump control word. The bits of this parameter can be used to control the relay outputs that switch pumps on and off.	-																	
	<table border="1"> <thead> <tr> <th>Bit</th> <th>Name</th> </tr> </thead> <tbody> <tr> <td>0</td> <td>Pump 1. <b>Note:</b> The setting of parameter <a href="#">78.02 Autochg trad</a> determines whether “Pump 1” refers to the first pump of the station, or the first auxiliary pump of the station.</td> </tr> <tr> <td>1</td> <td>Pump 2</td> </tr> <tr> <td>2</td> <td>Pump 3</td> </tr> <tr> <td>3</td> <td>Pump 4</td> </tr> <tr> <td>4</td> <td>Pump 5</td> </tr> <tr> <td>5</td> <td>Pump 6</td> </tr> <tr> <td>6</td> <td>Pump 7</td> </tr> <tr> <td>7</td> <td>Pump 8</td> </tr> </tbody> </table>	Bit	Name	0	Pump 1. <b>Note:</b> The setting of parameter <a href="#">78.02 Autochg trad</a> determines whether “Pump 1” refers to the first pump of the station, or the first auxiliary pump of the station.	1	Pump 2	2	Pump 3	3	Pump 4	4	Pump 5	5	Pump 6	6	Pump 7	7	Pump 8	
Bit	Name																			
0	Pump 1. <b>Note:</b> The setting of parameter <a href="#">78.02 Autochg trad</a> determines whether “Pump 1” refers to the first pump of the station, or the first auxiliary pump of the station.																			
1	Pump 2																			
2	Pump 3																			
3	Pump 4																			
4	Pump 5																			
5	Pump 6																			
6	Pump 7																			
7	Pump 8																			
05.03	Trad master	In traditional pump control, the number of the pump that is directly controlled by the drive.	1 = 1																	
05.04	Nbr aux pumps on	Number of auxiliary pumps running.	1 = 1																	
05.05	Flow act	Actual flow as calculated by the drive. See parameter group <a href="#">80 Flow calculation</a> (page 284).	100 = 1 m <sup>3</sup> /h																	
05.06	Flow by head	Flow calculated on the basis of the HQ performance curve. See parameter group <a href="#">80 Flow calculation</a> (page 284).	100 = 1 m <sup>3</sup> /h																	
05.07	Flow by power	Flow calculated on the basis of the PQ performance curve. See parameter group <a href="#">80 Flow calculation</a> (page 284).	100 = 1 m <sup>3</sup> /h																	
05.08	Total flow	Total calculated flow. Stored when the drive is not powered. Can be reset using parameter <a href="#">80.33 Sum flow reset</a> .	1 = 1 m <sup>3</sup>																	
05.09	Bypass ref	Reference used when parameter <a href="#">75.01 Operation mode</a> is set to <a href="#">Reg bypass</a> .	10 = 1 rpm																	
05.10	Speed ref	Final speed reference from the pump control logic.	10 = 1 rpm																	
05.20	kWh current read	Energy consumed during the current period. The length of the period is set by parameter <a href="#">83.02 Mon period</a> .	1 = 1 kWh																	
05.21	kWh prev read	Energy consumed during the last completed period. The length of the period is set by parameter <a href="#">83.02 Mon period</a> .	1 = 1 kWh																	
05.22	kWh posprev read	Energy consumed during the period before the last completed period. The length of the period is set by parameter <a href="#">83.02 Mon period</a> .	1 = 1 kWh																	
05.23	kWh cur mon read	Energy consumed during the current month.	1 = 1 kWh																	
05.24	kWh January	Energy consumed during last January.	1 = 1 kWh																	
05.25	kWh February	Energy consumed during last February.	1 = 1 kWh																	
05.26	kWh March	Energy consumed during last March.	1 = 1 kWh																	
05.27	kWh April	Energy consumed during last April.	1 = 1 kWh																	
05.28	kWh May	Energy consumed during last May.	1 = 1 kWh																	
05.29	kWh June	Energy consumed during last June.	1 = 1 kWh																	
05.30	kWh July	Energy consumed during last July.	1 = 1 kWh																	
05.31	kWh August	Energy consumed during last August.	1 = 1 kWh																	
05.32	kWh September	Energy consumed during last September.	1 = 1 kWh																	
05.33	kWh October	Energy consumed during last October.	1 = 1 kWh																	
05.34	kWh November	Energy consumed during last November.	1 = 1 kWh																	

## 132 Parameters

No.	Name/Value	Description	FbEq
05.35	kWh December	Energy consumed during last December.	1 = 1 kWh
05.36	First in order	The first pump in the current Autochange sequence.	1 = 1
05.37	Time autochg	Time elapsed since last Autochange.	1 = 1 ms
05.39	Next start node	(Only valid when the drive is master.) Node number of the next drive to be started.	1 = 1
05.48	Ramp status	Ramp times currently used.	-

Bit	Name	Information
0	Enabled	1 = Quick ramp mode is enabled.
1	QR Set 1	1 = Acceleration and deceleration times of quick ramp set 1 (par. <a href="#">75.31 Quick ramp acc1</a> and <a href="#">75.32 Quick ramp dec1</a> ) are in use.
2	QR Set 2	1 = Acceleration and deceleration times of quick ramp set 2 (par. <a href="#">75.35 Quick ramp acc2</a> and <a href="#">75.36 Quick ramp dec2</a> ) are in use.
3	Normal ramp	1 = Acceleration and deceleration times defined by par. <a href="#">22.02 Acc time</a> and <a href="#">22.03 Dec time</a> are in use.
4	Reserved	
5	Special ramp	1 = Acceleration and deceleration times defined by par. <a href="#">82.16 Clean step acc</a> and <a href="#">82.17 Clean step dec</a> , or the PID controller ramp-down time (par. <a href="#">81.17 Protect dec time</a> ) is in use.
6	1/2 swtch spd	1 = Actual speed is higher than the switchover speed (par. <a href="#">75.34 QR 1/2 swtch spd</a> ).
7	QR/NR swtch spd	1 = Actual speed is higher than the switchover speed (par. <a href="#">75.38 QR/NR swtch spd</a> ).

No.	Name/Value	Description	FbEq
<b>06 Drive status</b>		Drive status words.	
06.01	Status word1	Status word 1 of the drive.	-
	<b>Bit</b>	<b>Name</b>	<b>Information</b>
	0	Ready	1 = Drive is ready to receive start command. 0 = Drive is not ready.
	1	Enabled	1 = External run enable signal is received. 0 = No external run enable signal is received.
	2	Started	1 = Drive has received start command. 0 = Drive has not received start command.
	3	Running	1 = Drive is modulating. 0 = Drive is not modulating.
	4	Em off (off2)	1 = Emergency OFF2 is active. 0 = Emergency OFF2 is inactive.
	5	Em stop (off3)	1 = Emergency OFF3 (ramp stop) is active. 0 = Emergency OFF3 is inactive.
	6	Ack startinh	1 = Start inhibit is active. 0 = Start inhibit is inactive.
	7	Alarm	1 = Alarm is active. See chapter <a href="#">Fault tracing</a> . 0 = No alarm is active.
	8	Ext2 act	1 = External control EXT2 is active. 0 = External control EXT1 is active.
	9	Local fb	1 = Fieldbus local control is active. 0 = Fieldbus local control is inactive.
	10	Fault	1 = Fault is active. See chapter <a href="#">Fault tracing</a> . 0 = No fault is active.
	11	Local panel	1 = Local control is active, ie. drive is controlled from PC tool or control panel. 0 = Local control is inactive.
	12	Fault(-1)	1 = No fault is active. 0 = Fault is active. See chapter <a href="#">Fault tracing</a> .
	13...15	Reserved	

No.	Name/Value	Description	FbEq
06.02	Status word2	Status word 2 of the drive.	-
	<b>Bit</b>	<b>Name</b>	<b>Information</b>
	0	Start act	1 = Drive start command is active. 0 = Drive start command is inactive.
	1	Stop act	1 = Drive stop command is active. 0 = Drive stop command is inactive.
	2	Ready relay	1 = Ready to function: run enable signal on, no fault, emergency stop signal off, no ID run inhibition. Connected by default to DIO1 by par. <a href="#">14.03 DIO1 out src</a> . 0 = Not ready to function.
	3	Modulating	1 = Modulating: IGBTs are controlled, ie. the drive is RUNNING. 0 = No modulation: IGBTs are not controlled.
	4	Ref running	1 = Normal operation is enabled. Running. Drive follows the given reference. 0 = Normal operation is disabled. Drive is not following the given reference (eg. in magnetization phase drive is modulating).
	5	Reserved	
	6	Off1	1 = Emergency stop OFF1 is active. 0 = Emergency stop OFF1 is inactive.
	7	Start inh mask	1 = Maskable (by par. <a href="#">12.01 Start inhibit</a> ) start inhibit is active. 0 = No maskable start inhibit is active.
	8	Start inh nomask	1 = Non-maskable start inhibit is active. 0 = No non-maskable start inhibit is active.
	9	Chrg rel closed	1 = Charging relay is closed. 0 = Charging relay is open.
	10	Sto act	1 = Safe torque off function is active. See parameter <a href="#">30.07 Sto diagnostic</a> . 0 = Safe torque off function is inactive.
	11	Sleep active	1 = Sleep mode active. 0 = Sleep mode inactive.
	12	Ramp in 0	1 = Ramp Function Generator input is forced to zero. 0 = Normal operation.
	13	Ramp hold	1 = Ramp Function Generator output is held. 0 = Normal operation.
	14	Ramp out 0	1 = Ramp Function Generator output is forced to zero. 0 = Normal operation.
	15	Reserved	

No.	Name/Value	Description	FbEq
06.03	Speed ctrl stat	Speed control status word.	-
	<b>Bit</b>	<b>Name</b>	<b>Information</b>
	0	Speed act neg	1 = Actual speed is negative.
	1	Zero speed	1 = Actual speed has reached the zero speed limit (parameters <a href="#">19.06 Zero speed limit</a> and <a href="#">19.07 Zero speed delay</a> ).
	2	Above limit	1 = Actual speed has exceeded the supervision limit (parameter <a href="#">19.08 Above speed lim</a> ).
	3	At setpoint	1 = The difference between the actual speed and the unramped speed reference is within the speed window (parameter <a href="#">19.10 Speed window</a> ).
	4	Bal active	1 = Speed controller output is being forced to value of parameter <a href="#">27.35 PID bal ref</a> .
	5	PI tune active	1 = Speed controller autotuning procedure is active.
	6	PI tune request	1 = Speed controller autotuning has been requested by parameter <a href="#">23.20 PI tune mode</a> .
	7	PI tune done	1 = Speed controller autotuning procedure has been completed successfully.
	8	Speed not zero	1 = Speed controller autotuning has been requested when the drive was running, but zero speed has not been reached within preset maximum time.
	9...15	Reserved	
06.05	Limit word1	Limit word 1.	-
	<b>Bit</b>	<b>Name</b>	<b>Information</b>
	0	Torq lim	1 = Drive torque is being limited by the motor control (undervoltage control, current control, or pull-out control), or by the torque limit parameters in group <a href="#">20 Limits</a> .
	1	Spd ctl tlim min	1 = Speed controller output minimum torque limit is active. The limit is defined by parameter <a href="#">23.10 Min torq sp ctrl</a> .
	2	Spd ctl tlim max	1 = Speed controller output maximum torque limit is active. The limit is defined by parameter <a href="#">23.09 Max torq sp ctrl</a> .
	3...4	Reserved	
	5	Tlim max speed	1 = Torque reference maximum value is limited by the rush control, because of maximum speed limit <a href="#">20.01 Maximum speed</a> .
	6	Tlim min speed	1 = Torque reference minimum value is limited by the rush control, because of maximum speed limit <a href="#">20.02 Minimum speed</a> .
	7...15	Reserved	

No.	Name/Value	Description	FbEq																																										
06.07	Torq lim status	Torque controller limitation status word.	-																																										
		<table border="1"> <thead> <tr> <th>Bit</th> <th>Name</th> <th>Information</th> </tr> </thead> <tbody> <tr> <td>0</td> <td>Undervoltage</td> <td>1 = Intermediate circuit DC undervoltage. *</td> </tr> <tr> <td>1</td> <td>Overvoltage</td> <td>1 = Intermediate circuit DC overvoltage. *</td> </tr> <tr> <td>2...3</td> <td>Reserved</td> <td></td> </tr> <tr> <td>4</td> <td>Internal current</td> <td>1 = An inverter current limit is active. The limit is identified by bits 8...11.</td> </tr> <tr> <td>5</td> <td>Reserved</td> <td></td> </tr> <tr> <td>6</td> <td>Motor pull-out</td> <td>1 = Motor pull-out limit is active, i.e. the motor cannot produce more torque.</td> </tr> <tr> <td>7</td> <td>Reserved</td> <td></td> </tr> <tr> <td>8</td> <td>Thermal</td> <td>1 = Input current is limited by main circuit thermal limit.</td> </tr> <tr> <td>9</td> <td>INU maximum</td> <td>1 = Inverter maximum output current limit is active (limits the drive output current <math>I_{MAX}</math>). **</td> </tr> <tr> <td>10</td> <td>User current</td> <td>1 = Maximum inverter output current limit is active. The limit is defined by parameter <a href="#">20.05 Maximum current</a>. **</td> </tr> <tr> <td>11</td> <td>Thermal IGBT</td> <td>1 = Calculated thermal current value limits the inverter output current. **</td> </tr> <tr> <td>12</td> <td>Inu over-temp</td> <td>1 = Measured drive temperature has exceeded internal alarm limit.</td> </tr> <tr> <td>13...15</td> <td>Reserved</td> <td></td> </tr> </tbody> </table> <p>* One of bits 0...3 can be on simultaneously. The bit typically indicates the limit that is exceeded first.  ** Only one of bits 9...11 can be on simultaneously. The bit typically indicates the limit that is exceeded first.</p>	Bit	Name	Information	0	Undervoltage	1 = Intermediate circuit DC undervoltage. *	1	Overvoltage	1 = Intermediate circuit DC overvoltage. *	2...3	Reserved		4	Internal current	1 = An inverter current limit is active. The limit is identified by bits 8...11.	5	Reserved		6	Motor pull-out	1 = Motor pull-out limit is active, i.e. the motor cannot produce more torque.	7	Reserved		8	Thermal	1 = Input current is limited by main circuit thermal limit.	9	INU maximum	1 = Inverter maximum output current limit is active (limits the drive output current $I_{MAX}$ ). **	10	User current	1 = Maximum inverter output current limit is active. The limit is defined by parameter <a href="#">20.05 Maximum current</a> . **	11	Thermal IGBT	1 = Calculated thermal current value limits the inverter output current. **	12	Inu over-temp	1 = Measured drive temperature has exceeded internal alarm limit.	13...15	Reserved		
Bit	Name	Information																																											
0	Undervoltage	1 = Intermediate circuit DC undervoltage. *																																											
1	Overvoltage	1 = Intermediate circuit DC overvoltage. *																																											
2...3	Reserved																																												
4	Internal current	1 = An inverter current limit is active. The limit is identified by bits 8...11.																																											
5	Reserved																																												
6	Motor pull-out	1 = Motor pull-out limit is active, i.e. the motor cannot produce more torque.																																											
7	Reserved																																												
8	Thermal	1 = Input current is limited by main circuit thermal limit.																																											
9	INU maximum	1 = Inverter maximum output current limit is active (limits the drive output current $I_{MAX}$ ). **																																											
10	User current	1 = Maximum inverter output current limit is active. The limit is defined by parameter <a href="#">20.05 Maximum current</a> . **																																											
11	Thermal IGBT	1 = Calculated thermal current value limits the inverter output current. **																																											
12	Inu over-temp	1 = Measured drive temperature has exceeded internal alarm limit.																																											
13...15	Reserved																																												
06.12	Op mode ack	Operation mode acknowledge: 0 = Stopped, 1 = Speed, 10 = Scalar, 11 = Forced Magn (i.e. DC Hold)	1 = 1																																										
06.13	Superv status	Supervision status word. Bits 0...2 reflect the status of supervisory functions 1...3 respectively. The functions are configured in parameter group <a href="#">33 Supervision</a> (page <a href="#">214</a> ).	-																																										
06.14	Timed func stat	Bits 0...3 show the on/off status of the four timers (1...4 respectively) configured in parameter group <a href="#">36 Timed functions</a> (page <a href="#">226</a> ). Bit 4 is on if any one of the four timers is on.	-																																										
06.15	Counter status	Counter status word. Shows whether the maintenance counters configured in parameter group <a href="#">44 Maintenance</a> (page <a href="#">234</a> ) have exceeded their limits.	-																																										
		<table border="1"> <thead> <tr> <th>Bit</th> <th>Name</th> <th>Information</th> </tr> </thead> <tbody> <tr> <td>0</td> <td>Ontime1</td> <td>1 = On-time counter 1 has reached its preset limit.</td> </tr> <tr> <td>1</td> <td>Ontime2</td> <td>1 = On-time counter 2 has reached its preset limit.</td> </tr> <tr> <td>2</td> <td>Edge1</td> <td>1 = Rising edge counter 1 has reached its preset limit.</td> </tr> <tr> <td>3</td> <td>Edge2</td> <td>1 = Rising edge counter 2 has reached its preset limit.</td> </tr> <tr> <td>4</td> <td>Value1</td> <td>1 = Value counter 1 has reached its preset limit.</td> </tr> <tr> <td>5</td> <td>Value2</td> <td>1 = Value counter 2 has reached its preset limit.</td> </tr> </tbody> </table>	Bit	Name	Information	0	Ontime1	1 = On-time counter 1 has reached its preset limit.	1	Ontime2	1 = On-time counter 2 has reached its preset limit.	2	Edge1	1 = Rising edge counter 1 has reached its preset limit.	3	Edge2	1 = Rising edge counter 2 has reached its preset limit.	4	Value1	1 = Value counter 1 has reached its preset limit.	5	Value2	1 = Value counter 2 has reached its preset limit.																						
Bit	Name	Information																																											
0	Ontime1	1 = On-time counter 1 has reached its preset limit.																																											
1	Ontime2	1 = On-time counter 2 has reached its preset limit.																																											
2	Edge1	1 = Rising edge counter 1 has reached its preset limit.																																											
3	Edge2	1 = Rising edge counter 2 has reached its preset limit.																																											
4	Value1	1 = Value counter 1 has reached its preset limit.																																											
5	Value2	1 = Value counter 2 has reached its preset limit.																																											



No.	Name/Value	Description	FbEq	
06.17	Bit inverted sw	Shows the inverted values of the bits selected by parameters <a href="#">33.17...33.22</a> .	-	
	<b>Bit</b>	<b>Name</b>	<b>Information</b>	
	0	Inverted bit0	See parameter <a href="#">33.17 Bit0 invert src</a> .	
	1	Inverted bit1	See parameter <a href="#">33.18 Bit1 invert src</a> .	
	2	Inverted bit2	See parameter <a href="#">33.19 Bit2 invert src</a> .	
	3	Inverted bit3	See parameter <a href="#">33.20 Bit3 invert src</a> .	
	4	Inverted bit4	See parameter <a href="#">33.21 Bit4 invert src</a> .	
	5	Inverted bit5	See parameter <a href="#">33.22 Bit5 invert src</a> .	
06.20	Pump status word	Pump status word.	-	
	<b>Bit</b>	<b>Name</b>	<b>Value</b>	<b>Information</b>
	0	Trad	1	Traditional pump control mode active.
	1	Reg bypass	1	PID controller bypass mode active.
	2	Multi pump	1	Multipump functionality (via drive-to-drive link) active.
	3	Level control	1	Level control active.
	4	Sleep	1	Sleep mode active.
	5	Boosting	1	Sleep boost active.
	6	Pipe filling	1	Soft pipefill function active.
	7	Bypass	1	PID controller bypass mode active.
	8	Cleaning	1	Cleaning sequence active.
	9	Analyzer ID run	1	Reserved
	10	PID ref freeze	1	PID controller input frozen.
	11	PID out freeze	1	PID controller output frozen.
	12	Balancing	1	PID balancing reference in force.
	13	No aux pumps	1	No auxiliary pumps available to be started.
	14	Autochange	1	Autochange function active.
	15	High prot spd	1	Outlet pressure monitoring: forced reference active.
	16	Low prot spd	1	Inlet pressure monitoring: forced reference active.
	17	Speed ref 2 act	1	Speed reference 2 active.
	18	Ext2 Speed mode	1	Speed control selected for external control location EXT2 by parameter <a href="#">12.05 Ext2 ctrl mode</a> .
	19...31	Reserved		

No.	Name/Value	Description	FbEq
06.21	Level status	Level control status word.	-
	<b>Bit</b>	<b>Name</b>	<b>Value</b> <b>Information</b>
	0	Low level 1	1 Low level 1 reached.
	1	Low level 2	1 Low level 2 reached.
	2	Stop level	1 Stop level reached.
	3	Start level 1	1 Start level 1 reached.
	4	Start level 2	1 Start level 2 reached.
	5	Start level 3	1 Start level 3 reached.
	6	Start level 4	1 Start level 4 reached.
	7	Start level 5	1 Start level 5 reached.
	8	Start level 6	1 Start level 6 reached.
	9	Start level 7	1 Start level 7 reached.
	10	Start level 8	1 Start level 8 reached.
	11	High level 1	1 High level 1 reached.
	12	High level 2	1 High level 2 reached.
	13	High speed	1 High speed reached.
	14...31	Reserved	
06.22	MF status word	Multipump communication status word.	-
	<b>Bit</b>	<b>Name</b>	<b>Value</b> <b>Information</b>
	0	Master	1 Drive is master.
	1	Follower	1 Drive is follower.
	2	Master running	1 Master drive is running.
	3	Copy of mstr	1 Sync mode active (par. 75.03 is set to <i>Copy of mstr</i> ).
	4	Node 1	1 (Only valid if the drive is master.) Drive with node number 1 is present on the drive-to-drive link.
	5	Node 2	1 (Only valid if the drive is master.) Drive with node number 2 is present on the drive-to-drive link.
	6	Node 3	1 (Only valid if the drive is master.) Drive with node number 3 is present on the drive-to-drive link.
	7	Node 4	1 (Only valid if the drive is master.) Drive with node number 4 is present on the drive-to-drive link.
	8	Node 5	1 (Only valid if the drive is master.) Drive with node number 5 is present on the drive-to-drive link.
	9	Node 6	1 (Only valid if the drive is master.) Drive with node number 6 is present on the drive-to-drive link.
	10	Node 7	1 (Only valid if the drive is master.) Drive with node number 7 is present on the drive-to-drive link.
	11	Node 8	1 (Only valid if the drive is master.) Drive with node number 8 is present on the drive-to-drive link.
	12...31	Reserved	

08 Alarms & faults		Alarm and fault information.	
08.01	Active fault	Fault code of the latest fault.	1 = 1
08.02	Last fault	Fault code of the 2nd latest fault.	1 = 1
08.03	Fault time hi	Time (real time or power-on time) at which the active fault occurred in format dd.mm.yy (day, month and year).	1 = 1 d

No.	Name/Value	Description	FbEq
08.04	Fault time lo	Time (real time or power-on time) at which the active fault occurred in format hh.mm.ss (hours, minutes and seconds).	1 = 1
08.05	Alarm logger1	Alarm logger 1. Can be reset by entering a 0.	-
	<b>Bit</b>	<b>Alarm</b>	
	0...2	Reserved	
	3	<a href="#">SAFE TORQUE OFF</a> (page 336)	
	4	<a href="#">STO MODE CHANGE</a> (page 336)	
	5	<a href="#">MOTOR TEMPERATURE</a> (page 336)	
	6	<a href="#">EMERGENCY OFF</a> (page 336)	
	7	<a href="#">RUN ENABLE</a> (page 336)	
	8	<a href="#">MOTOR ID-RUN</a> (page 337)	
	9	<a href="#">EMERGENCY STOP</a> (page 337)	
	10...12	Reserved	
	13	<a href="#">DEVICE OVERTEMP</a> (page 337)	
	14	<a href="#">INTBOARD OVERTEMP</a> (page 337)	
	15	Reserved	
08.06	Alarm logger2	Alarm logger 2. Can be reset by entering a 0.	-
	<b>Bit</b>	<b>Alarm</b>	
	0	<a href="#">DEVICE OVERTEMP</a> (page 337)	
	1	<a href="#">FIELD BUS COMM</a> (page 337)	
	2	<a href="#">PANEL CTRL LOSS</a> (page 337)	
	3	<a href="#">AI SUPERVISION</a> (page 337)	
	4	<a href="#">FB PAR CONF</a> (page 337)	
	5	<a href="#">NO MOTOR DATA</a> (page 337)	
	6...15	Reserved	
08.07	Alarm logger3	Alarm logger 3. Can be reset by entering a 0.	-
	<b>Bit</b>	<b>Alarm</b>	
	0...2	Reserved	
	3	<a href="#">PS COMM</a> (page 338)	
	4	<a href="#">RESTORE</a> (page 338)	
	5	<a href="#">CUR MEAS CALIBRATION</a> (page 338)	
	6	Reserved	
	7	<a href="#">EARTH FAULT</a> (page 338)	
	8	<a href="#">AUTORESET</a> (page 338)	
	9	<a href="#">MOTOR NOM VALUE</a> (page 338)	
	10	Reserved	
	11	<a href="#">STALL</a> (page 338)	
	12	<a href="#">LOAD CURVE</a> (page 338)	
	13	<a href="#">LOAD CURVE PAR</a> (page 338)	
	14	<a href="#">U/f-curve par</a> (page 338)	
	15	Reserved	

## 140 Parameters

No.	Name/Value	Description	FbEq
08.08	Alarm logger4	Alarm logger 4. Can be reset by entering a 0.	-
	<b>Bit</b>	<b>Alarm</b>	
	0	<a href="#">OPTION COMM LOSS</a> (page 338)	
	1	<a href="#">SOLUTION ALARM</a> (page 343)	
	2	<a href="#">MOTOR TEMP2</a> (page 339)	
	3	<a href="#">IGBT OVERLOAD</a> (page 339)	
	4	<a href="#">IGBT TEMP</a> (page 339)	
	5	<a href="#">COOLING</a> (page 339)	
	6	<a href="#">MENU CHANGED</a> (page 339)	
	7	<a href="#">TEMP MEAS FAILURE</a> (page 340)	
	8	Maintenance counter alarms 2055...2071 (page 340)	
	9	<a href="#">DC NOT CHARGED</a> (page 340)	
	10	<a href="#">AUTOTUNE FAILED</a> (page 340)	
	11	<a href="#">START INTERLOCK</a> (page 340)	
	12	<a href="#">EFB COMM LOSS</a> (page 341)	
	13...14	Reserved	
	15	<a href="#">AO CALIBRATION</a> (page 341)	
08.09	Alarm logger5	Alarm logger 5. Can be reset by entering a 0.	-
	<b>Bit</b>	<b>Alarm</b>	
	0	<a href="#">PIPEFILL TIMEOUT</a> (page 341)	
	1	<a href="#">MIN FLOW</a> (page 341)	
	2	<a href="#">MAX FLOW</a> (page 341)	
	3	<a href="#">LOW PRESSURE</a> (page 341)	
	4	<a href="#">HIGH PRESSURE</a> (page 341)	
	5	<a href="#">VERY LOW PRESS</a> (page 341)	
	6	<a href="#">VERY HIGH PRESS</a> (page 341)	
	7	<a href="#">PROFILE HIGH</a> (page 341)	
	8	<a href="#">MAX CLEANINGS</a> (page 342)	
	9	<a href="#">ALL PUMPS INLOCKD</a> (page 342)	
	10	<a href="#">ENERGY LIMIT</a> (page 342)	
	11	<a href="#">DATE WRONG</a> (page 342)	
	12...13	Reserved	
	14	<a href="#">BOOSTING</a> (page 342)	
	15	<a href="#">PIPE FILLING</a> (page 342)	

No.	Name/Value	Description	FbEq
08.10	Alarm logger6	Alarm logger 6. Can be reset by entering a 0.	-
	<b>Bit</b>	<b>Alarm</b>	
	0	<a href="#">NO MORE PUMPS</a> (page 342)	
	1	<a href="#">CLEANING</a> (page 342)	
	2	<a href="#">AUTOCHANGE</a> (page 342)	
	3	<a href="#">SLEEPING</a> (page 342)	
	4	<a href="#">START DELAY</a> (page 342)	
	5	<a href="#">LC TANK FULL</a> (page 342)	
	6	<a href="#">LC TANK EMPTY</a> (page 343)	
	7	<a href="#">MF MASTER LOST</a> (page 343)	
	8	<a href="#">MF NO SHARED DATA</a> (page 343)	
	9...15	Reserved	
08.15	Alarm word1	Alarm word 1. This alarm word is refreshed, ie, when the alarm terminates, the corresponding bit is cleared.	-
	<b>Bit</b>	<b>Alarm</b>	
	0...2	Reserved	
	3	<a href="#">SAFE TORQUE OFF</a> (page 336)	
	4	<a href="#">STO MODE CHANGE</a> (page 336)	
	5	<a href="#">MOTOR TEMPERATURE</a> (page 336)	
	6	<a href="#">EMERGENCY OFF</a> (page 336)	
	7	<a href="#">RUN ENABLE</a> (page 336)	
	8	<a href="#">MOTOR ID-RUN</a> (page 337)	
	9	<a href="#">EMERGENCY STOP</a> (page 337)	
	10...12	Reserved	
	13	<a href="#">DEVICE OVERTEMP</a> (page 337)	
	14	<a href="#">INTBOARD OVERTEMP</a> (page 337)	
	15	Reserved	
08.16	Alarm word2	Alarm word 2. This alarm word is refreshed, ie, when the alarm terminates, the corresponding bit is cleared.	-
	<b>Bit</b>	<b>Alarm</b>	
	0	<a href="#">DEVICE OVERTEMP</a> (page 337)	
	1	<a href="#">FIELD BUS COMM</a> (page 337)	
	2	<a href="#">PANEL CTRL LOSS</a> (page 337)	
	3	<a href="#">AI SUPERVISION</a> (page 337)	
	4	<a href="#">FB PAR CONF</a> (page 337)	
	5	<a href="#">NO MOTOR DATA</a> (page 337)	
	6...15	Reserved	



No.	Name/Value	Description	FbEq
08.20	Pump fault word	Pump fault word.	-
	<b>Bit</b>	<b>Alarm</b>	
	0	<a href="#">MIN FLOW</a> (page 352)	
	1	<a href="#">MAX FLOW</a> (page 352)	
	2	<a href="#">LOW PRESSURE</a> (page 352)	
	3	<a href="#">HIGH PRESSURE</a> (page 352)	
	4	<a href="#">VERY LOW PRESS</a> (page 352)	
	5	<a href="#">VERY HIGH PRESS</a> (page 352)	
	6	<a href="#">MAX CLEANINGS</a> (page 353)	
	7	<a href="#">PIPEFILL TOUT</a> (page 352)	
	8	<a href="#">MF MASTER LOST</a> (page 353)	
	9	<a href="#">MF NO SHARED DATA</a> (page 353)	
	10...31	Reserved	
08.21	Pump alarm word	Pump alarm word.	-
	<b>Bit</b>	<b>Alarm</b>	
	0	<a href="#">MIN FLOW</a> (page 341)	
	1	<a href="#">MAX FLOW</a> (page 341)	
	2	<a href="#">LOW PRESSURE</a> (page 341)	
	3	<a href="#">HIGH PRESSURE</a> (page 341)	
	4	<a href="#">VERY LOW PRESS</a> (page 341)	
	5	<a href="#">VERY HIGH PRESS</a> (page 341)	
	6	<a href="#">PROFILE HIGH</a> (page 341)	
	7	<a href="#">MAX CLEANINGS</a> (page 342)	
	8	<a href="#">CLEANING</a> (page 342)	
	9	<a href="#">PIPEFILL TIMEOUT</a> (page 341)	
	10	<a href="#">ALL PUMPS INLOCKD</a> (page 342)	
	11	<a href="#">ENERGY LIMIT</a> (page 342)	
	12	<a href="#">DATE WRONG</a> (page 342)	
	13...14	Reserved	
	15	<a href="#">BOOSTING</a> (page 342)	
	16	<a href="#">PIPE FILLING</a> (page 342)	
	17	<a href="#">NO MORE PUMPS</a> (page 342)	
	18	<a href="#">AUTOCHANGE</a> (page 342)	
	19	<a href="#">SLEEPING</a> (page 342)	
	20	<a href="#">START DELAY</a> (page 342)	
	21	<a href="#">MF MASTER LOST</a> (page 343)	
	22	Reserved	
	23	<a href="#">LC TANK FULL</a> (page 342)	
	24	<a href="#">LC TANK EMPTY</a> (page 343)	
	25	<a href="#">MF NO SHARED DATA</a> (page 343)	
	26...31	Reserved	
<b>09 System info</b>		Drive type, program revision and option slot occupation information.	
09.01	Drive type	Displays the drive type (for example, ACQ810).	-

No.	Name/Value	Description	FbEq
09.02	Drive rating ID	Displays the inverter type (ACQ810-...) of the drive. 0 = Unconfigured, 201 = 02A7-4, 202 = 03A0-4, 203 = 03A5-4, 204 = 04A9-4, 205 = 06A3-4, 206 = 08A3-4, 207 = 11A0-4, 208 = 14A4-4, 209 = 021A-4, 210 = 028A-4, 211 = 032A-4, 212 = 035A-4, 213 = 040A-4, 214 = 053A-4, 215 = 067A-4, 216 = 080A-4, 217 = 098A-4, 218 = 138A-4, 220 = 162A-4, 221 = 203A-4, 222 = 240A-4, 223 = 286A-4, 224 = 302A-4, 225 = 361A-4, 226 = 414A-4, 227 = 477A-4, 228 = 550A-4, 229 = 616A-4, 230 = 704A-4, 231 = 377A-4, 232 = 480A-4, 233 = 570A-4, 234 = 634A-4, 235 = 700A-4, 236 = 785A-4, 237 = 857A-4, 241 = 02A7-2, 242 = 03A0-2, 243 = 03A5-2, 244 = 04A9-2, 245 = 06A3-2, 246 = 08A3-2, 247 = 11A0-2, 248 = 14A4-2, 249 = 021A-2, 250 = 028A-2, 251 = 032A-2, 252 = 035A-2, 253 = 040A-2, 254 = 053A-2, 255 = 067A-2, 256 = 080A-2	1 = 1
09.03	Firmware ID	Displays the firmware name. E.g. UIFQ.	-
09.04	Firmware ver	Displays the version of the firmware package in the drive, e.g. 2002 hex.	-
09.05	Firmware patch	Displays the version of the firmware patch in the drive.	1 = 1
09.10	Int logic ver	Displays the version of the logic on the main circuit board of the drive.	-
09.13	Slot 1 VIE name	Displays the type of the VIE logic used in the optional module in option slot 1.	1 = 1
09.14	Slot 1 VIE ver	Displays the version of the VIE logic used in the optional module in option slot 1.	-
09.20	Option slot1	Displays the type of the optional module in option slot 1. 0 = No option, 1 = No comm, 2 = Unknown, 6 = FIO-01, 7 = FIO-11, 21 = FIO-21, 24 = FIO-31	1 = 1
09.21	Option slot2	Displays the type of the optional module in option slot 2. 0 = No option, 1 = No comm, 2 = Unknown, 8 = FPBA-01, 11 = FDNA-01, 13 = FENA-11, 14 = FLON-01, 19 = FB COMMON (FENA-11/FECA-01/FEPL-02), 22 = FSCA-01	1 = 1

10 Start/stop/dir		Start/stop/direction, run enable and emergency stop source selections; start inhibit and start interlock configuration.							
10.01	Ext1 start func	Selects the source of start and stop commands for external control location 1 (EXT1). <b>Note:</b> This parameter cannot be changed while the drive is running.							
	Not sel	No start or stop command sources selected.	0						
	In1	The source of the start and stop commands is selected by parameter <a href="#">10.02 Ext1 start in1</a> . The states of the source bit are interpreted as follows: <table border="1" data-bbox="482 1778 931 1921"> <thead> <tr> <th>State of source (via par 10.02)</th> <th>Command</th> </tr> </thead> <tbody> <tr> <td>1</td> <td>Start</td> </tr> <tr> <td>0</td> <td>Stop</td> </tr> </tbody> </table>	State of source (via par 10.02)	Command	1	Start	0	Stop	1
State of source (via par 10.02)	Command								
1	Start								
0	Stop								



No.	Name/Value	Description	FbEq															
	3-wire	<p>The sources of the start and stop commands is selected by parameters <a href="#">10.02 Ext1 start in1</a> and <a href="#">10.03 Ext1 start in2</a>. The state transitions of the source bits are interpreted as follows:</p> <table border="1"> <thead> <tr> <th>State of source 1 (via par. <a href="#">10.02</a>)</th> <th>State of source 2 (via par. <a href="#">10.03</a>)</th> <th>Command</th> </tr> </thead> <tbody> <tr> <td>0 -&gt; 1</td> <td>1</td> <td>Start</td> </tr> <tr> <td>Any</td> <td>1 -&gt; 0</td> <td>Stop</td> </tr> <tr> <td>Any</td> <td>0</td> <td>Stop</td> </tr> </tbody> </table>	State of source 1 (via par. <a href="#">10.02</a> )	State of source 2 (via par. <a href="#">10.03</a> )	Command	0 -> 1	1	Start	Any	1 -> 0	Stop	Any	0	Stop	2			
State of source 1 (via par. <a href="#">10.02</a> )	State of source 2 (via par. <a href="#">10.03</a> )	Command																
0 -> 1	1	Start																
Any	1 -> 0	Stop																
Any	0	Stop																
	FBA	The start and stop commands are taken from the fieldbus Control Word selected by parameter <a href="#">50.15 FBA cw used</a> .	3															
		Reserved.	4															
	In1F In2R	<p>The source selected by <a href="#">10.02 Ext1 start in1</a> is the forward start signal, the source selected by <a href="#">10.03 Ext1 start in2</a> is the reverse start signal.</p> <table border="1"> <thead> <tr> <th>State of source 1 (via par. <a href="#">10.02</a>)</th> <th>State of source 2 (via par. <a href="#">10.03</a>)</th> <th>Command</th> </tr> </thead> <tbody> <tr> <td>0</td> <td>0</td> <td>Stop</td> </tr> <tr> <td>1</td> <td>0</td> <td>Start forward</td> </tr> <tr> <td>0</td> <td>1</td> <td>Start reverse</td> </tr> <tr> <td>1</td> <td>1</td> <td>Stop</td> </tr> </tbody> </table>	State of source 1 (via par. <a href="#">10.02</a> )	State of source 2 (via par. <a href="#">10.03</a> )	Command	0	0	Stop	1	0	Start forward	0	1	Start reverse	1	1	Stop	5
State of source 1 (via par. <a href="#">10.02</a> )	State of source 2 (via par. <a href="#">10.03</a> )	Command																
0	0	Stop																
1	0	Start forward																
0	1	Start reverse																
1	1	Stop																
	In1St In2Dir	The source selected by <a href="#">10.02 Ext1 start in1</a> is the start signal (0 = stop, 1 = start), the source selected by <a href="#">10.03 Ext1 start in2</a> is the direction signal (0 = forward, 1 = reverse).	6															
	Panel	The start and stop commands are taken from the control panel.	7															
10.02	Ext1 start in1	<p>Selects source 1 of start and stop commands for external control location EXT1. See parameter <a href="#">10.01 Ext1 start func</a>, selections <a href="#">In1</a> and <a href="#">3-wire</a>.</p> <p><b>Note:</b> This parameter cannot be changed while the drive is running.</p>																
	DI1	Digital input DI1 (as indicated by <a href="#">02.01 DI status</a> , bit 0).	1073742337															
	DIO4	Digital input/output DIO4 (as indicated by <a href="#">02.03 DIO status</a> , bit 3).	1073938947															
	Timed func	Bit 4 of parameter <a href="#">06.14 Timed func stat</a> . The bit is on when at least one of the four timers configured in parameter group <a href="#">36 Timed functions</a> is on.	1074005518															
	Const	Constant and bit pointer settings (see <a href="#">Terms and abbreviations</a> on page 115).	-															
	Pointer																	
10.03	Ext1 start in2	<p>Selects source 2 of start and stop commands for external control location EXT1. See parameter <a href="#">10.01 Ext1 start func</a>, selection <a href="#">3-wire</a>.</p> <p><b>Note:</b> This parameter cannot be changed while the drive is running.</p>																
	DI2	Digital input DI2 (as indicated by <a href="#">02.01 DI status</a> , bit 1).	1073807873															
	DI5	Digital input DI5 (as indicated by <a href="#">02.01 DI status</a> , bit 4).	1074004481															
	DIO5	Digital input/output DIO5 (as indicated by <a href="#">02.03 DIO status</a> , bit 4).	1074004483															



No.	Name/Value	Description	FbEq															
	Const	Bit pointer setting (see <a href="#">Terms and abbreviations</a> on page 115).	-															
	Pointer																	
10.04	Ext2 start func	Selects the source of start and stop commands for external control location 2 (EXT2). <b>Note:</b> This parameter cannot be changed while the drive is running.																
	Not sel	No start or stop command sources selected.	0															
	In1	The source of the start and stop commands is selected by parameter <a href="#">10.05 Ext2 start in1</a> . The states of the source bit are interpreted as follows: <table border="1" data-bbox="484 633 931 779"> <thead> <tr> <th>State of source (via par <a href="#">10.05</a>)</th> <th>Command</th> </tr> </thead> <tbody> <tr> <td>1</td> <td>Start</td> </tr> <tr> <td>0</td> <td>Stop</td> </tr> </tbody> </table>	State of source (via par <a href="#">10.05</a> )	Command	1	Start	0	Stop	1									
State of source (via par <a href="#">10.05</a> )	Command																	
1	Start																	
0	Stop																	
	3-wire	The sources of the start and stop commands is selected by parameters <a href="#">10.05 Ext2 start in1</a> and <a href="#">10.06 Ext2 start in2</a> . The state transitions of the source bits are interpreted as follows: <table border="1" data-bbox="484 956 1186 1137"> <thead> <tr> <th>State of source 1 (via par. <a href="#">10.05</a>)</th> <th>State of source 2 (via par. <a href="#">10.06</a>)</th> <th>Command</th> </tr> </thead> <tbody> <tr> <td>0 -&gt; 1</td> <td>1</td> <td>Start</td> </tr> <tr> <td>Any</td> <td>1 -&gt; 0</td> <td>Stop</td> </tr> <tr> <td>Any</td> <td>0</td> <td>Stop</td> </tr> </tbody> </table>	State of source 1 (via par. <a href="#">10.05</a> )	State of source 2 (via par. <a href="#">10.06</a> )	Command	0 -> 1	1	Start	Any	1 -> 0	Stop	Any	0	Stop	2			
State of source 1 (via par. <a href="#">10.05</a> )	State of source 2 (via par. <a href="#">10.06</a> )	Command																
0 -> 1	1	Start																
Any	1 -> 0	Stop																
Any	0	Stop																
	FBA	The start and stop commands are taken from the fieldbus Control Word selected by parameter <a href="#">50.15 FBA cw used</a> .	3															
		Reserved.	4															
	In1F In2R	The source selected by <a href="#">10.05 Ext2 start in1</a> is the forward start signal, the source selected by <a href="#">10.06 Ext2 start in2</a> is the reverse start signal. <table border="1" data-bbox="484 1408 1186 1626"> <thead> <tr> <th>State of source 1 (via par. <a href="#">10.05</a>)</th> <th>State of source 2 (via par. <a href="#">10.06</a>)</th> <th>Command</th> </tr> </thead> <tbody> <tr> <td>0</td> <td>0</td> <td>Stop</td> </tr> <tr> <td>1</td> <td>0</td> <td>Start forward</td> </tr> <tr> <td>0</td> <td>1</td> <td>Start reverse</td> </tr> <tr> <td>1</td> <td>1</td> <td>Stop</td> </tr> </tbody> </table>	State of source 1 (via par. <a href="#">10.05</a> )	State of source 2 (via par. <a href="#">10.06</a> )	Command	0	0	Stop	1	0	Start forward	0	1	Start reverse	1	1	Stop	5
State of source 1 (via par. <a href="#">10.05</a> )	State of source 2 (via par. <a href="#">10.06</a> )	Command																
0	0	Stop																
1	0	Start forward																
0	1	Start reverse																
1	1	Stop																
	In1St In2Dir	The source selected by <a href="#">10.05 Ext2 start in1</a> is the start signal (0 = stop, 1 = start), the source selected by <a href="#">10.06 Ext2 start in2</a> is the direction signal (0 = forward, 1 = reverse).	6															
	Panel	The start and stop commands are taken from the control panel.	7															
10.05	Ext2 start in1	Selects source 1 of start and stop commands for external control location EXT2. See parameter <a href="#">10.04 Ext2 start func</a> , selections <a href="#">In1</a> and <a href="#">3-wire</a> . <b>Note:</b> This parameter cannot be changed while the drive is running.																
	DI1	Digital input DI1 (as indicated by <a href="#">02.01 DI status</a> , bit 0).	1073742337															
	DI2	Digital input DI2 (as indicated by <a href="#">02.01 DI status</a> , bit 1).	1073807873															

No.	Name/Value	Description	FbEq
	DIO4	Digital input/output DIO4 (as indicated by <a href="#">02.03 DIO status</a> , bit 3).	1073938947
	Timed func	Bit 4 of parameter <a href="#">06.14 Timed func stat</a> . The bit is on when any one of the four timers configured in parameter group <a href="#">36 Timed functions</a> is on.	1074005518
	Const	Bit pointer setting (see <a href="#">Terms and abbreviations</a> on page <a href="#">115</a> ).	-
	Pointer		
10.06	Ext2 start in2	Selects source 2 of start and stop commands for external control location EXT2. See parameter <a href="#">10.04 Ext2 start func</a> , selection <a href="#">3-wire</a> . <b>Note:</b> This parameter cannot be changed while the drive is running.	
	DI2	Digital input DI2 (as indicated by <a href="#">02.01 DI status</a> , bit 1).	1073807873
	DI5	Digital input DI5 (as indicated by <a href="#">02.01 DI status</a> , bit 4).	1074004481
	Const	Bit pointer setting (see <a href="#">Terms and abbreviations</a> on page <a href="#">115</a> ).	-
	Pointer		
10.10	Fault reset sel	Selects the source of the external fault reset signal. The signal resets the drive after a fault trip if the cause of the fault no longer exists. 0 -> 1 = Fault reset.	
	DI1	Digital input DI1 (as indicated by <a href="#">02.01 DI status</a> , bit 0).	1073742337
	DI2	Digital input DI2 (as indicated by <a href="#">02.01 DI status</a> , bit 1).	1073807873
	DI3	Digital input DI3 (as indicated by <a href="#">02.01 DI status</a> , bit 2).	1073873409
	DI4	Digital input DI4 (as indicated by <a href="#">02.01 DI status</a> , bit 3).	1073938945
	DI5	Digital input DI5 (as indicated by <a href="#">02.01 DI status</a> , bit 4).	1074004481
	Const	Bit pointer setting (see <a href="#">Terms and abbreviations</a> on page <a href="#">115</a> ).	-
	Pointer		
10.11	Run enable	Selects the source of the external run enable signal. If the run enable signal is switched off, the drive will not start, or coasts to stop if running. 1 = Run enable. <b>Note:</b> This parameter cannot be changed while the drive is running.	
	DI1	Digital input DI1 (as indicated by <a href="#">02.01 DI status</a> , bit 0).	1073742337
	DI2	Digital input DI2 (as indicated by <a href="#">02.01 DI status</a> , bit 1).	1073807873
	DI3	Digital input DI3 (as indicated by <a href="#">02.01 DI status</a> , bit 2).	1073873409
	DI4	Digital input DI4 (as indicated by <a href="#">02.01 DI status</a> , bit 3).	1073938945
	DI5	Digital input DI5 (as indicated by <a href="#">02.01 DI status</a> , bit 4).	1074004481
	COMM.CW	External signal required through the fieldbus Control Word (as indicated by <a href="#">02.22 FBA main cw</a> , bit 7).	1074201122
	Const	Bit pointer setting (see <a href="#">Terms and abbreviations</a> on page <a href="#">115</a> ).	-
	Pointer		

No.	Name/Value	Description	FbEq
10.13	Em stop off3	Selects the source of the emergency stop OFF3 signal. The drive is stopped along the emergency stop ramp time defined by parameter <a href="#">22.12 Em stop time</a> . 0 = OFF3 active. <b>Note:</b> This parameter cannot be changed while the drive is running.	
	DI1	Digital input DI1 (as indicated by <a href="#">02.01 DI status</a> , bit 0).	1073742337
	DI2	Digital input DI2 (as indicated by <a href="#">02.01 DI status</a> , bit 1).	1073807873
	DI3	Digital input DI3 (as indicated by <a href="#">02.01 DI status</a> , bit 2).	1073873409
	DI4	Digital input DI4 (as indicated by <a href="#">02.01 DI status</a> , bit 3).	1073938945
	DI5	Digital input DI5 (as indicated by <a href="#">02.01 DI status</a> , bit 4).	1074004481
	Const	Bit pointer setting (see <a href="#">Terms and abbreviations</a> on page <a href="#">115</a> ).	-
	Pointer		
10.15	Em stop off1	Selects the source of the emergency stop OFF1 signal. The drive is stopped using the active deceleration time. Emergency stop can also be activated through fieldbus ( <a href="#">02.22 FBA main cw</a> or <a href="#">02.36 EFB main cw</a> ). 0 = OFF1 active. <b>Note:</b> This parameter cannot be changed while the drive is running.	
	DI1	Digital input DI1 (as indicated by <a href="#">02.01 DI status</a> , bit 0).	1073742337
	DI2	Digital input DI2 (as indicated by <a href="#">02.01 DI status</a> , bit 1).	1073807873
	DI3	Digital input DI3 (as indicated by <a href="#">02.01 DI status</a> , bit 2).	1073873409
	DI4	Digital input DI4 (as indicated by <a href="#">02.01 DI status</a> , bit 3).	1073938945
	DI5	Digital input DI5 (as indicated by <a href="#">02.01 DI status</a> , bit 4).	1074004481
	Const	Bit pointer setting (see <a href="#">Terms and abbreviations</a> on page <a href="#">115</a> ).	-
	Pointer		

No.	Name/Value	Description	FbEq
10.17	Start enable	<p>Selects the source for the Start enable signal. 1 = Start enable.</p> <p>If the signal is switched off, the drive will not start or coasts to stop if running.</p> <p><b>Note:</b> This parameter cannot be changed while the drive is running.</p> <p><b>Note:</b> The functionality of the Start enable signal is different from the Run enable signal.</p> <p><b>Example:</b> External damper control application using Start enable and Run enable. Motor can start only after the damper is fully open.</p>	
<p>The diagram illustrates the sequence of events for a motor start with damper control. It shows the following signals and their timing:</p> <ul style="list-style-type: none"> <li><b>Start/Stop commands (group 10):</b> A pulse that initiates the drive start.</li> <li><b>Start enable signal (10.17):</b> A signal that becomes active (high) when the drive is started.</li> <li><b>Started (06.01 Status word 1 bit 2):</b> A signal that becomes active (high) when the drive starts.</li> <li><b>Damper status:</b> A signal that ramps up from low to high during the 'Damper opening time', remains high during 'Damper open', and ramps down to low during 'Damper closing time'.</li> <li><b>Run enable signal from the damper end switch when the damper is fully opened (10.11):</b> A signal that becomes active (high) when the damper is fully open.</li> <li><b>Motor speed:</b> A signal that ramps up during 'Acceleration time (22.02)', remains constant during 'Damper open', and ramps down during 'Deceleration time (22.03)'.</li> </ul>			
	D11	Digital input DI1 (as indicated by <a href="#">02.01 DI status</a> , bit 0).	1073742337
	D12	Digital input DI2 (as indicated by <a href="#">02.01 DI status</a> , bit 1).	1073807873
	D13	Digital input DI3 (as indicated by <a href="#">02.01 DI status</a> , bit 2).	1073873409
	D14	Digital input DI4 (as indicated by <a href="#">02.01 DI status</a> , bit 3).	1073938945
	D15	Digital input DI5 (as indicated by <a href="#">02.01 DI status</a> , bit 4).	1074004481
	Const	Bit pointer setting (see <a href="#">Terms and abbreviations</a> on page <a href="#">115</a> ).	-
	Pointer		

No.	Name/Value	Description	FbEq
10.19	Start inhibit	<p>Enables the start inhibit function. If the drive is not actively started and running, the function ignores a pending start command in any of the following situations, and a new start command is required:</p> <ul style="list-style-type: none"> <li>• the drive trips on a fault and the fault is reset.</li> <li>• the run enable signal is activated while the start command is active (see parameter <a href="#">10.11 Run enable</a>).</li> <li>• control changes from local to remote.</li> <li>• external control switches from EXT1 to EXT2 or vice versa.</li> </ul> <p>A new rising edge of the start command is needed after the start inhibit has been activated.</p> <p>Note that in certain applications it is necessary to allow the drive to restart.</p>	
	Disabled	The start inhibit function is disabled.	0
	Enabled	The start inhibit function is enabled.	1
10.20	Start intrl func	Defines how the start interlock input (DIIL) on the JCU control unit affects the drive operation.	
	Off2 stop	<p>With the drive running:</p> <ul style="list-style-type: none"> <li>• 1 = Normal operation.</li> <li>• 0 = Stop by coasting. The drive can be restarted by restoring the start interlock signal and switching the start signal from 0 to 1.</li> </ul> <p>With the drive stopped:</p> <ul style="list-style-type: none"> <li>• 1 = Starting allowed.</li> <li>• 0 = Starting not allowed.</li> </ul>	0
	Off3 stop	<p>With the drive running:</p> <ul style="list-style-type: none"> <li>• 1 = Normal operation.</li> <li>• 0 = Stop by ramping. The deceleration time is defined by parameter <a href="#">22.12 Em stop time</a>. The drive can be restarted by restoring the start interlock signal and switching the start signal from 0 to 1.</li> </ul> <p>With the drive stopped:</p> <ul style="list-style-type: none"> <li>• 1 = Starting allowed.</li> <li>• 0 = Starting not allowed.</li> </ul>	1
<b>11 Start/stop mode</b>		Start and stop modes; magnetization settings; DC hold configuration.	
11.01	Start mode	<p>Selects the motor start function.</p> <p><b>Notes:</b></p> <ul style="list-style-type: none"> <li>• Selections <i>Fast</i> and <i>Const time</i> are ignored if parameter <a href="#">99.05</a> is set to <i>Scalar</i>. Selection <i>Automatic</i> is recommended for synchronous reluctance motors.</li> <li>• Starting to a rotating machine is not possible when DC magnetizing is selected (<i>Fast</i> or <i>Const time</i>).</li> </ul>	
	Fast	<p>The drive pre-magnetizes the motor before start. The pre-magnetizing time is determined automatically, being typically 200 ms to 2 s depending on motor size. This mode should be selected if a high break-away torque is required.</p> <p><b>Note:</b> This parameter cannot be changed while the drive is running.</p>	0

No.	Name/Value	Description	FbEq										
	Const time	<p>The drive pre-magnetizes the motor before start. The pre-magnetizing time is defined by parameter <a href="#">11.02 Dc-magn time</a>. This mode should be selected if constant pre-magnetizing time is required (e.g. if the motor start must be synchronized with the release of a mechanical brake). This setting also guarantees the highest possible break-away torque when the pre-magnetizing time is set long enough.</p> <p> <b>WARNING!</b> The drive will start after the set magnetizing time has passed even if motor magnetization is not completed. In applications where a full break-away torque is essential, ensure that the constant magnetizing time is long enough to allow generation of full magnetization and torque.</p>	1										
	Automatic	<p>Automatic start guarantees optimal motor start in most cases. It includes the flying start function (starting to a rotating machine) and the automatic restart function (a stopped motor can be restarted immediately without waiting the motor flux to die away). The drive motor control program identifies the flux as well as the mechanical state of the motor and starts the motor instantly under all conditions.</p> <p><b>Note:</b> If parameter <a href="#">99.05 Motor ctrl mode</a> is set to <i>Scalar</i>, no flying start or automatic restart is possible by default.</p>	2										
11.02	Dc-magn time	<p>Defines the constant DC magnetizing time. See parameter <a href="#">11.01 Start mode</a>. After the start command, the drive automatically premagnetizes the motor the set time.</p> <p>To ensure full magnetizing, set this value to the same value as or higher than the rotor time constant. If not known, use the rule-of-thumb value given in the table below:</p> <table border="1" data-bbox="561 1153 1262 1400"> <thead> <tr> <th>Motor rated power</th> <th>Constant magnetizing time</th> </tr> </thead> <tbody> <tr> <td>&lt; 1 kW</td> <td>≥ 50 to 100 ms</td> </tr> <tr> <td>1 to 10 kW</td> <td>≥ 100 to 200 ms</td> </tr> <tr> <td>10 to 200 kW</td> <td>≥ 200 to 1000 ms</td> </tr> <tr> <td>200 to 1000 kW</td> <td>≥ 1000 to 2000 ms</td> </tr> </tbody> </table> <p><b>Note:</b> This parameter cannot be changed while the drive is running.</p>	Motor rated power	Constant magnetizing time	< 1 kW	≥ 50 to 100 ms	1 to 10 kW	≥ 100 to 200 ms	10 to 200 kW	≥ 200 to 1000 ms	200 to 1000 kW	≥ 1000 to 2000 ms	
Motor rated power	Constant magnetizing time												
< 1 kW	≥ 50 to 100 ms												
1 to 10 kW	≥ 100 to 200 ms												
10 to 200 kW	≥ 200 to 1000 ms												
200 to 1000 kW	≥ 1000 to 2000 ms												
	0 ... 10000 ms	Constant DC magnetizing time.	1 = 1 ms										
11.03	Stop mode	Selects the motor stop function.											
	Coast	<p>Stop by cutting of the motor power supply. The motor coasts to a stop.</p> <p> <b>WARNING!</b> If the mechanical brake is used, ensure it is safe to stop the drive by coasting.</p>	1										
	Ramp	Stop along ramp. See parameter group <a href="#">22 Speed ref ramp</a> on page <a href="#">186</a> .	2										
11.04	Dc hold speed	Defines the DC hold speed. See parameter <a href="#">11.06 Dc hold</a> .											
	0.0 ... 1000.0 rpm	DC hold speed.	10 = 1 rpm										
11.05	Dc hold curr ref	Defines the DC hold current in percent of the motor nominal current. See parameter <a href="#">11.06 Dc hold</a> .											
	0 ... 100%	DC hold current.	1 = 1%										

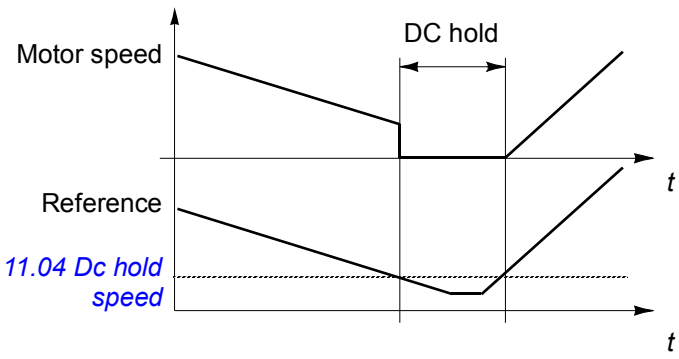
No.	Name/Value	Description	FbEq
11.06	Dc hold	<p>Enables the DC hold function. The function makes it possible to lock the rotor at zero speed.</p> <p>When both the reference and the speed drop below the value of parameter <a href="#">11.04 Dc hold speed</a>, the drive will stop generating sinusoidal current and start to inject DC into the motor. The current is set by parameter <a href="#">11.05 Dc hold curr ref</a>. When the reference speed exceeds parameter <a href="#">11.04 Dc hold speed</a>, normal drive operation continues.</p>  <p>0 = DC hold disabled 1 = DC hold enabled</p> <p><b>Notes:</b></p> <ul style="list-style-type: none"> <li>• The DC hold function has no effect if the start signal is switched off.</li> <li>• The DC hold function can only be activated in speed control mode.</li> <li>• The DC hold function cannot be activated if parameter <a href="#">99.05 Motor ctrl mode</a> is set to <i>Scalar</i>.</li> <li>• Injecting DC current into the motor causes the motor to heat up. In applications where long DC hold times are required, externally ventilated motors should be used. If the DC hold period is long, the DC hold cannot prevent the motor shaft from rotating if a constant load is applied to the motor.</li> </ul>	
	Const	Bit pointer setting (see <a href="#">Terms and abbreviations</a> on page <a href="#">115</a> ).	-
	Pointer		

12 Operating mode		Selection of external control location and EXT2 operating mode.	
12.01	Ext1/Ext2 sel	Selects the external control location (EXT1 or EXT2), or the source of a selection signal (0 = EXT1; 1 = EXT2).	
	Ext1	EXT1 is active.	0
	Ext2	EXT2 is active.	1
	DI1	The external control location is determined by the status of digital input DI1 (as indicated by <a href="#">02.01 DI status</a> , bit 0).	1073742337
	DI2	The external control location is determined by the status of digital input DI2 (as indicated by <a href="#">02.01 DI status</a> , bit 1).	1073807873
	DI3	The external control location is determined by the status of digital input DI3 (as indicated by <a href="#">02.01 DI status</a> , bit 2).	1073873409
	DI4	The external control location is determined by the status of digital input DI4 (as indicated by <a href="#">02.01 DI status</a> , bit 3).	1073938945
	DI5	The external control location is determined by the status of digital input DI5 (as indicated by <a href="#">02.01 DI status</a> , bit 4).	1074004481

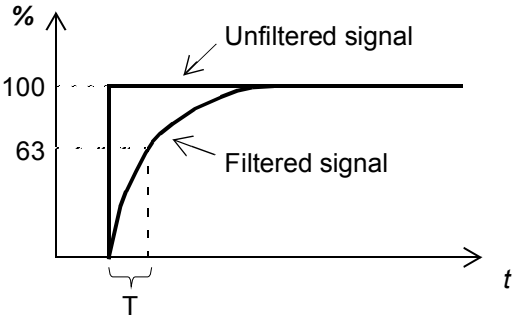

No.	Name/Value	Description	FbEq
	Const	Bit pointer setting (see <a href="#">Terms and abbreviations</a> on page 115).	-
	Pointer		
12.05	Ext2 ctrl mode	Selects the operating mode for external control location EXT2.	
	Speed	Speed control. The reference is taken from the source defined by parameter <a href="#">21.02 Speed ref2 sel.</a>	1
	PID	PID control.	2
<b>13 Analogue inputs</b>		Analog input signal processing.	
13.01	AI1 filt time	<p>Defines the filter time constant for analog input AI1.</p>  $O = I \times (1 - e^{-t/T})$ <p>I = filter input (step)  O = filter output  t = time  T = filter time constant</p> <p><b>Note:</b> The signal is also filtered due to the signal interface hardware (approximately 0.25 ms time constant). This cannot be changed by any parameter.</p>	
	0.000 ... 30.000 s	Filter time constant.	1000 = 1 s
13.02	AI1 max	Defines the maximum value for analog input AI1. The input type (current or voltage) is selected a jumper on the JCU Control Unit (see the <i>Hardware Manual</i> of the drive). See also parameter <a href="#">13.31 AI tune.</a>	
	-22.000 ... 22.000 mA or -11.000 ... 11.000 V	Maximum AI1 value.	1000 = 1 unit
13.03	AI1 min	Defines the minimum value for analog input AI1. The input type (current or voltage) is selected with a jumper on the JCU Control Unit (see the <i>Hardware Manual</i> of the drive).	
	-22.000 ... 22.000 mA or -11.000 ... 11.000 V	Minimum AI1 value.	1000 = 1 unit

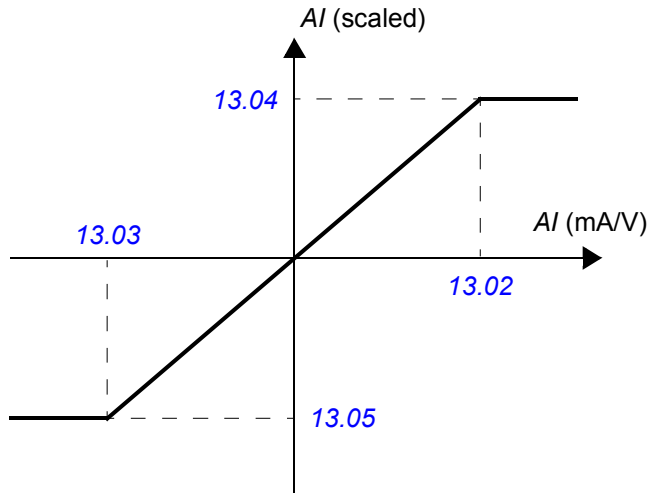

## 154 Parameters

No.	Name/Value	Description	FbEq
13.04	AI1 max scale	<p>Defines the real value that corresponds to the maximum analog input AI1 value defined by parameter <a href="#">13.02 AI1 max</a>.</p> 	
	-32768.000 ... 32768.000	Real value corresponding to maximum AI1 value.	1000 = 1
13.05	AI1 min scale	<p>Defines the real value that corresponds to the minimum analog input AI1 value defined by parameter <a href="#">13.03 AI1 min</a>. See the drawing at parameter <a href="#">13.04 AI1 max scale</a>.</p>	
	-32768.000 ...32768.000	Real value corresponding to minimum AI1 value.	1000 = 1
13.06	AI2 filt time	<p>Defines the filter time constant for analog input AI2. See parameter <a href="#">13.01 AI1 filt time</a>.</p>	
	0.000 ... 30.000 s	Filter time constant.	1000 = 1 s
13.07	AI2 max	<p>Defines the maximum value for analog input AI2. The input type (current or voltage) is selected with a jumper on the JCU Control Unit (see the <i>Hardware Manual</i> of the drive). See also parameter <a href="#">13.31 AI tune</a>.</p>	
	-22.000 ... 22.000 mA or -11.000 ... 11.000 V	AI2 maximum value.	1000 = 1 unit
13.08	AI2 min	<p>Defines the minimum value for analog input AI2. The input type (current or voltage) is selected with a jumper on the JCU Control Unit (see the <i>Hardware Manual</i> of the drive).</p>	
	-22.000 ... 22.000 mA or -11.000 ... 11.000 V	AI2 minimum value.	1000 = 1 unit

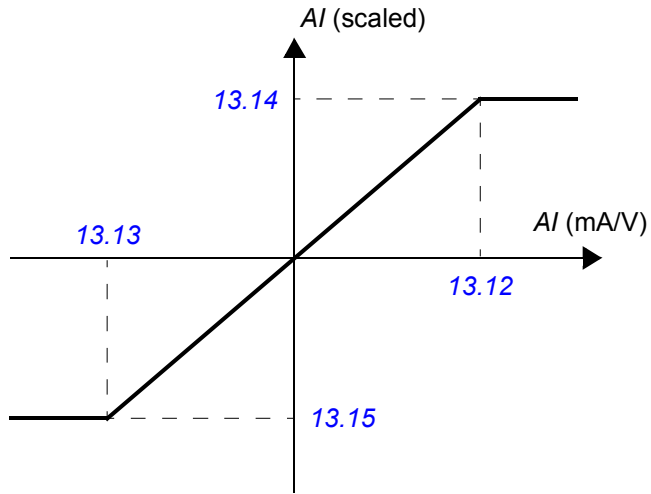
No.	Name/Value	Description	FbEq
13.09	AI2 max scale	Defines the real value that corresponds to the maximum analog input AI2 value defined by parameter <a href="#">13.07 AI2 max.</a>	
	-32768.000 ... 32768.000	Real value corresponding to maximum AI2 value.	1000 = 1
13.10	AI2 min scale	Defines the real value that corresponds to the minimum analog input AI2 value defined by parameter <a href="#">13.08 AI2 min.</a> See the drawing at parameter <a href="#">13.09 AI2 max scale.</a>	
	-32768.000 ... 32768.000	Real value corresponding to minimum AI2 value.	1000 = 1
13.11	AI3 filt time	Defines the filter time constant for analog input AI3. See parameter <a href="#">13.01 AI1 filt time.</a>	
	0.000 ... 30.000 s	Filter time constant.	1000 = 1 s
13.12	AI3 max	Defines the maximum value for analog input AI3. The input type depends on the type and/or settings of the I/O extension module installed. See the user documentation of the extension module.	
	-22.000 ... 22.000 mA or -11.000 ... 11.000 V	AI3 maximum value.	1000 = 1 unit
13.13	AI3 min	Defines the minimum value for analog input AI3. The input type depends on the type and/or settings of the I/O extension module installed. See the user documentation of the extension module.	
	-22.000 ... 22.000 mA or -11.000 ... 11.000 V	AI3 minimum value.	1000 = 1 unit

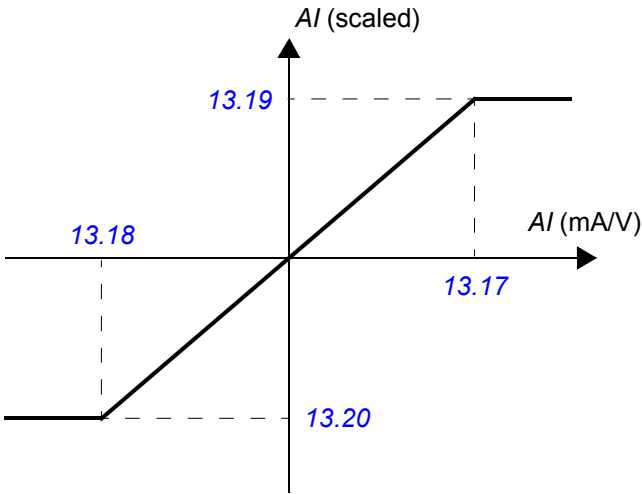
No.	Name/Value	Description	FbEq
13.14	AI3 max scale	<p>Defines the real value that corresponds to the maximum analog input AI3 value defined by parameter <a href="#">13.12 AI3 max</a>.</p> 	
	-32768.000 ... 32768.000	Real value corresponding to maximum AI3 value.	1000 = 1
13.15	AI3 min scale	<p>Defines the real value that corresponds to the minimum analog input AI3 value defined by parameter <a href="#">13.13 AI3 min</a>. See the drawing at parameter <a href="#">13.14 AI3 max scale</a>.</p>	
	-32768.000 ... 32768.000	Real value corresponding to minimum AI3 value.	1000 = 1
13.16	AI4 filt time	<p>Defines the filter time constant for analog input AI4. See parameter <a href="#">13.01 AI1 filt time</a>.</p>	
	0.000 ... 30.000 s	Filter time constant.	1000 = 1 s
13.17	AI4 max	<p>Defines the maximum value for analog input AI4. The input type depends on the type and/or settings of the I/O extension module installed. See the user documentation of the extension module.</p>	
	-22.000 ... 22.000 mA or -11.000 ... 11.000 V	AI4 maximum value.	1000 = 1 unit
13.18	AI4 min	<p>Defines the minimum value for analog input AI4. The input type depends on the type and/or settings of the I/O extension module installed. See the user documentation of the extension module.</p>	
	-22.000 ... 22.000 mA or -11.000 ... 11.000 V	AI4 minimum value.	1000 = 1 unit

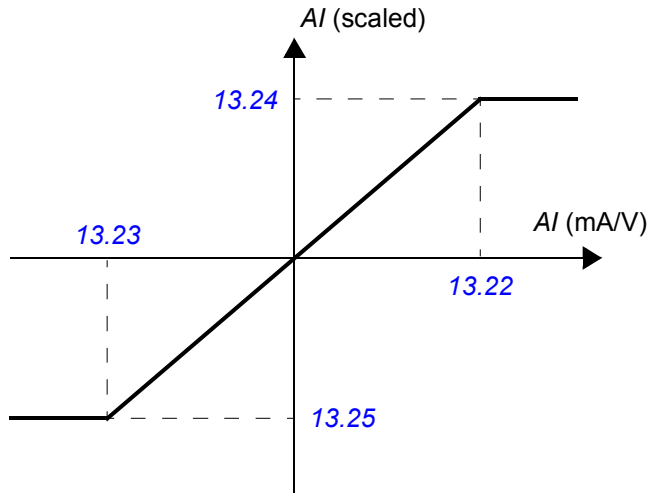
No.	Name/Value	Description	FbEq
13.19	AI4 max scale	Defines the real value that corresponds to the maximum analog input AI4 value defined by parameter <a href="#">13.17 AI4 max.</a> 	
	-32768.000 ... 32768.000	Real value corresponding to maximum AI4 value.	1000 = 1
13.20	AI4 min scale	Defines the real value that corresponds to the minimum analog input AI4 value defined by parameter <a href="#">13.18 AI4 min.</a> See the drawing at parameter <a href="#">13.19 AI4 max scale.</a>	
	-32768.000 ... 32768.000	Real value corresponding to minimum AI4 value.	1000 = 1
13.21	AI5 filt time	Defines the filter time constant for analog input AI5. See parameter <a href="#">13.01 AI1 filt time.</a>	
	0.000 ... 30.000 s	Filter time constant.	1000 = 1 s
13.22	AI5 max	Defines the maximum value for analog input AI5. The input type depends on the type and/or settings of the I/O extension module installed. See the user documentation of the extension module.	
	-22.000 ... 22.000 mA or -11.000 ... 11.000 V	AI5 maximum value.	1000 = 1 unit
13.23	AI5 min	Defines the minimum value for analog input AI5. The input type depends on the type and/or settings of the I/O extension module installed. See the user documentation of the extension module.	
	-22.000 ... 22.000 mA or -11.000 ... 11.000 V	AI5 minimum value.	1000 = 1 unit

No.	Name/Value	Description	FbEq
13.24	AI5 max scale	<p>Defines the real value that corresponds to the maximum analog input AI5 value defined by parameter <a href="#">13.22 AI5 max</a>.</p> 	
	-32768.000 ... 32768.000	Real value corresponding to maximum AI5 value.	1000 = 1
13.25	AI5 min scale	<p>Defines the real value that corresponds to the minimum analog input AI5 value defined by parameter <a href="#">13.23 AI5 min</a>. See the drawing at parameter <a href="#">13.24 AI5 max scale</a>.</p>	
	-32768.000 ... 32768.000	Real value corresponding to minimum AI5 value.	1000 = 1
13.31	AI tune	<p>Triggers the AI tuning function. Connect the signal to the input and select the appropriate tuning function.</p>	
	No action	AI tune is not activated.	0
	AI1 min tune	Current analog input AI1 signal value is set as minimum value of AI1 into parameter <a href="#">13.03 AI1 min</a> . The value reverts back to <i>No action</i> automatically.	1
	AI1 max tune	Current analog input AI1 signal value is set as maximum value of AI1 into parameter <a href="#">13.02 AI1 max</a> . The value reverts back to <i>No action</i> automatically.	2
	AI2 min tune	Current analog input AI2 signal value is set as minimum value of AI2 into parameter <a href="#">13.08 AI2 min</a> . The value reverts back to <i>No action</i> automatically.	3
	AI2 max tune	Current analog input AI2 signal value is set as maximum value of AI2 into parameter <a href="#">13.07 AI2 max</a> . The value reverts back to <i>No action</i> automatically.	4
13.32	AI superv func	<p>Selects how the drive reacts when analog input signal limit is reached. The limit is selected by parameter <a href="#">13.33 AI superv cw</a>.</p>	
	No	No action taken.	0
	Fault	The drive trips on an <i>AI SUPERVISION (0x8110)</i> fault.	1
	Spd ref Safe	<p>The drive generates an <i>AI SUPERVISION (0x8110)</i> alarm and sets the speed to the speed defined by parameter <a href="#">30.02 Speed ref safe</a>.</p> <p> <b>WARNING!</b> Make sure that it is safe to continue operation in case of a communication break.</p>	2

No.	Name/Value	Description	FbEq															
	Last speed	The drive generates an <i>AI SUPERVISION (0x8110)</i> alarm and freezes the speed to the level the drive was operating at. The speed is determined by the average speed over the previous 10 seconds.  <b>WARNING!</b> Make sure that it is safe to continue operation in case of a communication break.	3															
13.33	AI superv cw	Selects the analog input signal supervision limit.																
		<table border="1"> <thead> <tr> <th>Bit</th> <th>Supervision</th> <th>Action selected by parameter <i>13.32 AI superv func</i> is taken if</th> </tr> </thead> <tbody> <tr> <td>0</td> <td>AI1 min sup</td> <td>AI1 signal value falls below the value defined by equation: par. <i>13.03 AI1 min</i> - 0.5 mA or V</td> </tr> <tr> <td>1</td> <td>AI1 max sup</td> <td>AI1 signal value exceeds the value defined by equation: par. <i>13.02 AI1 max</i> + 0.5 mA or V</td> </tr> <tr> <td>2</td> <td>AI2 min sup</td> <td>AI2 signal value falls below the value defined by equation: par. <i>13.08 AI2 min</i> - 0.5 mA or V</td> </tr> <tr> <td>3</td> <td>AI2 max sup</td> <td>AI2 signal value exceeds the value defined by equation: par. <i>13.07 AI2 max</i> + 0.5 mA or V</td> </tr> </tbody> </table>	Bit	Supervision	Action selected by parameter <i>13.32 AI superv func</i> is taken if	0	AI1 min sup	AI1 signal value falls below the value defined by equation: par. <i>13.03 AI1 min</i> - 0.5 mA or V	1	AI1 max sup	AI1 signal value exceeds the value defined by equation: par. <i>13.02 AI1 max</i> + 0.5 mA or V	2	AI2 min sup	AI2 signal value falls below the value defined by equation: par. <i>13.08 AI2 min</i> - 0.5 mA or V	3	AI2 max sup	AI2 signal value exceeds the value defined by equation: par. <i>13.07 AI2 max</i> + 0.5 mA or V	
Bit	Supervision	Action selected by parameter <i>13.32 AI superv func</i> is taken if																
0	AI1 min sup	AI1 signal value falls below the value defined by equation: par. <i>13.03 AI1 min</i> - 0.5 mA or V																
1	AI1 max sup	AI1 signal value exceeds the value defined by equation: par. <i>13.02 AI1 max</i> + 0.5 mA or V																
2	AI2 min sup	AI2 signal value falls below the value defined by equation: par. <i>13.08 AI2 min</i> - 0.5 mA or V																
3	AI2 max sup	AI2 signal value exceeds the value defined by equation: par. <i>13.07 AI2 max</i> + 0.5 mA or V																
		<b>Example:</b> If parameter value is set to 0b0010, bit 1 <i>AI1 max sup</i> is selected.																
<b>14 Digital I/O</b>		Configuration of digital input/outputs, relay outputs, the frequency input, and the frequency output.																
14.01	DI invert mask	Inverts status of digital inputs as reported by <i>02.01 DI status</i> .																
		<table border="1"> <thead> <tr> <th>Bit</th> <th>Name</th> </tr> </thead> <tbody> <tr> <td>0</td> <td>1 = Invert DI1</td> </tr> <tr> <td>1</td> <td>1 = Invert DI2</td> </tr> <tr> <td>2</td> <td>1 = Invert DI3</td> </tr> <tr> <td>3</td> <td>1 = Invert DI4</td> </tr> <tr> <td>4</td> <td>1 = Invert DI5</td> </tr> </tbody> </table>	Bit	Name	0	1 = Invert DI1	1	1 = Invert DI2	2	1 = Invert DI3	3	1 = Invert DI4	4	1 = Invert DI5				
Bit	Name																	
0	1 = Invert DI1																	
1	1 = Invert DI2																	
2	1 = Invert DI3																	
3	1 = Invert DI4																	
4	1 = Invert DI5																	
14.02	DIO1 conf	Selects whether DIO1 is used as a digital output or input.																
	Output	DIO1 is used as a digital output.	0															
	Input	DIO1 is used as a digital input.	1															
	Freq input	DIO1 is used as a frequency input.	2															
14.03	DIO1 out src	Selects a drive signal to be connected to digital output DIO1 (when <i>14.02 DIO1 conf</i> is set to <i>Output</i> ).																
	Trad pump7	Bit 6 of <i>05.02 Trad pump cmd</i> (see page 131).	1074136322															
	Trad pump8	Bit 7 of <i>05.02 Trad pump cmd</i> (see page 131).	1074201858															
	Ready	Bit 0 of <i>06.01 Status word1</i> (see page 133).	1073743361															
	Enabled	Bit 1 of <i>06.01 Status word1</i> (see page 133).	1073808897															
	Started	Bit 2 of <i>06.01 Status word1</i> (see page 133).	1073874433															
	Running	Bit 3 of <i>06.01 Status word1</i> (see page 133).	1073939969															
	Alarm	Bit 7 of <i>06.01 Status word1</i> (see page 133).	1074202113															
	Ext2 active	Bit 8 of <i>06.01 Status word1</i> (see page 133).	1074267649															
	Fault	Bit 10 of <i>06.01 Status word1</i> (see page 133).	1074398721															

No.	Name/Value	Description	FbEq
	Fault(-1)	Bit 12 of <a href="#">06.01 Status word1</a> (see page <a href="#">133</a> ).	1074529793
	Ready relay	Bit 2 of <a href="#">06.02 Status word2</a> (see page <a href="#">134</a> ).	1073874434
	RunningRelay	Bit 3 of <a href="#">06.02 Status word2</a> (see page <a href="#">134</a> ).	1073939970
	Ref running	Bit 4 of <a href="#">06.02 Status word2</a> (see page <a href="#">134</a> ).	1074005506
	Charge ready	Bit 9 of <a href="#">06.02 Status word2</a> (see page <a href="#">134</a> ).	1074333186
	Neg speed	Bit 0 of <a href="#">06.03 Speed ctrl stat</a> (see page <a href="#">135</a> ).	1073743363
	Zero speed	Bit 1 of <a href="#">06.03 Speed ctrl stat</a> (see page <a href="#">135</a> ).	1073808899
	Above limit	Bit 2 of <a href="#">06.03 Speed ctrl stat</a> (see page <a href="#">135</a> ).	1073874435
	At setpoint	Bit 3 of <a href="#">06.03 Speed ctrl stat</a> (see page <a href="#">135</a> ).	1073939971
	Supervision1	Bit 0 of <a href="#">06.13 Superv status</a> (see page <a href="#">136</a> ).	1073743373
	Supervision2	Bit 1 of <a href="#">06.13 Superv status</a> (see page <a href="#">136</a> ).	1073808909
	Supervision3	Bit 2 of <a href="#">06.13 Superv status</a> (see page <a href="#">136</a> ).	1073874445
	Const	Bit pointer setting (see <a href="#">Terms and abbreviations</a> on page <a href="#">115</a> ).	-
	Pointer		
14.04	DIO1 Ton	Defines the on (activation) delay for digital input/output DIO1 when <a href="#">14.02 DIO1 conf</a> is set to <a href="#">Output</a> .	
<p style="text-align: center;"> <math>t_{On}</math>     <a href="#">14.04 DIO1 Ton</a>  <math>t_{Off}</math>     <a href="#">14.05 DIO1 Toff</a> </p>			
	0.0 ... 3000.0 s	On (activation) delay for DIO1 when set as an output.	10 = 1 s
14.05	DIO1 Toff	Defines the off (deactivation) delay for digital input/output DIO1 when <a href="#">14.02 DIO1 conf</a> is set to <a href="#">Output</a> . See parameter <a href="#">14.04 DIO1 Ton</a> .	
	0.0 ... 3000.0 s	Off (deactivation) delay for DIO1 when set as an output.	10 = 1 s
14.06	DIO2 conf	Selects whether DIO2 is used as a digital output, digital input or frequency input.	
	Output	DIO2 is used as a digital output.	0
	Input	DIO2 is used as a digital input.	1
	Freq output	DIO2 is used as a frequency output.	3
14.07	DIO2 out src	Selects a drive signal to be connected to digital output DIO2 (when <a href="#">14.06 DIO2 conf</a> is set to <a href="#">Output</a> ).	
	Ready	Bit 0 of <a href="#">06.01 Status word1</a> (see page <a href="#">133</a> ).	1073743361
	Enabled	Bit 1 of <a href="#">06.01 Status word1</a> (see page <a href="#">133</a> ).	1073808897



No.	Name/Value	Description	FbEq
	Started	Bit 2 of <a href="#">06.01 Status word1</a> (see page <a href="#">133</a> ).	1073874433
	Running	Bit 3 of <a href="#">06.01 Status word1</a> (see page <a href="#">133</a> ).	1073939969
	Alarm	Bit 7 of <a href="#">06.01 Status word1</a> (see page <a href="#">133</a> ).	1074202113
	Ext2 active	Bit 8 of <a href="#">06.01 Status word1</a> (see page <a href="#">133</a> ).	1074267649
	Fault	Bit 10 of <a href="#">06.01 Status word1</a> (see page <a href="#">133</a> ).	1074398721
	Fault(-1)	Bit 12 of <a href="#">06.01 Status word1</a> (see page <a href="#">133</a> ).	1074529793
	Ready relay	Bit 2 of <a href="#">06.02 Status word2</a> (see page <a href="#">134</a> ).	1073874434
	RunningRelay	Bit 3 of <a href="#">06.02 Status word2</a> (see page <a href="#">134</a> ).	1073939970
	Ref running	Bit 4 of <a href="#">06.02 Status word2</a> (see page <a href="#">134</a> ).	1074005506
	Charge ready	Bit 9 of <a href="#">06.02 Status word2</a> (see page <a href="#">134</a> ).	1074333186
	Neg speed	Bit 0 of <a href="#">06.03 Speed ctrl stat</a> (see page <a href="#">135</a> ).	1073743363
	Zero speed	Bit 1 of <a href="#">06.03 Speed ctrl stat</a> (see page <a href="#">135</a> ).	1073808899
	Above limit	Bit 2 of <a href="#">06.03 Speed ctrl stat</a> (see page <a href="#">135</a> ).	1073874435
	At setpoint	Bit 3 of <a href="#">06.03 Speed ctrl stat</a> (see page <a href="#">135</a> ).	1073939971
	Supervision1	Bit 0 of <a href="#">06.13 Superv status</a> (see page <a href="#">136</a> ).	1073743373
	Supervision2	Bit 1 of <a href="#">06.13 Superv status</a> (see page <a href="#">136</a> ).	1073808909
	Supervision3	Bit 2 of <a href="#">06.13 Superv status</a> (see page <a href="#">136</a> ).	1073874445
	Const	Bit pointer setting (see <a href="#">Terms and abbreviations</a> on page <a href="#">115</a> ).	-
	Pointer		
14.08	DIO2 Ton	Defines the on (activation) delay for digital input/output DIO2 when <a href="#">14.06 DIO2 conf</a> is set to <i>Output</i> .	
<p style="text-align: center;"> <math>t_{On}</math>     <a href="#">14.08 DIO2 Ton</a>  <math>t_{Off}</math>     <a href="#">14.09 DIO2 Toff</a> </p>			
	0.0 ... 3000.0 s	On (activation) delay for DIO2 when set as an output.	10 = 1 s
14.09	DIO2 Toff	Defines the off (deactivation) delay for digital input/output DIO2 when <a href="#">14.06 DIO2 conf</a> is set to <i>Output</i> . See parameter <a href="#">14.08 DIO2 Ton</a> .	
	0.0 ... 3000.0 s	Off (deactivation) delay for DIO2 when set as an output.	10 = 1 s
14.10	DIO3 conf	Selects whether DIO3 is used as a digital output or digital input.	
	Output	DIO3 is used as a digital output.	0
	Input	DIO3 is used as a digital input.	1

## 162 Parameters

No.	Name/Value	Description	FbEq
14.11	DIO3 out src	Selects a drive signal to be connected to digital output DIO3 (when <a href="#">14.10 DIO3 conf</a> is set to <i>Output</i> ).	
	Ready	Bit 0 of <a href="#">06.01 Status word1</a> (see page <a href="#">133</a> ).	1073743361
	Enabled	Bit 1 of <a href="#">06.01 Status word1</a> (see page <a href="#">133</a> ).	1073808897
	Started	Bit 2 of <a href="#">06.01 Status word1</a> (see page <a href="#">133</a> ).	1073874433
	Running	Bit 3 of <a href="#">06.01 Status word1</a> (see page <a href="#">133</a> ).	1073939969
	Alarm	Bit 7 of <a href="#">06.01 Status word1</a> (see page <a href="#">133</a> ).	1074202113
	Ext2 active	Bit 8 of <a href="#">06.01 Status word1</a> (see page <a href="#">133</a> ).	1074267649
	Fault	Bit 10 of <a href="#">06.01 Status word1</a> (see page <a href="#">133</a> ).	1074398721
	Fault(-1)	Bit 12 of <a href="#">06.01 Status word1</a> (see page <a href="#">133</a> ).	1074529793
	Ready relay	Bit 2 of <a href="#">06.02 Status word2</a> (see page <a href="#">134</a> ).	1073874434
	RunningRelay	Bit 3 of <a href="#">06.02 Status word2</a> (see page <a href="#">134</a> ).	1073939970
	Ref running	Bit 4 of <a href="#">06.02 Status word2</a> (see page <a href="#">134</a> ).	1074005506
	Charge ready	Bit 9 of <a href="#">06.02 Status word2</a> (see page <a href="#">134</a> ).	1074333186
	Neg speed	Bit 0 of <a href="#">06.03 Speed ctrl stat</a> (see page <a href="#">135</a> ).	1073743363
	Zero speed	Bit 1 of <a href="#">06.03 Speed ctrl stat</a> (see page <a href="#">135</a> ).	1073808899
	Above limit	Bit 2 of <a href="#">06.03 Speed ctrl stat</a> (see page <a href="#">135</a> ).	1073874435
	At setpoint	Bit 3 of <a href="#">06.03 Speed ctrl stat</a> (see page <a href="#">135</a> ).	1073939971
	Supervision1	Bit 0 of <a href="#">06.13 Superv status</a> (see page <a href="#">136</a> ).	1073743373
	Supervision2	Bit 1 of <a href="#">06.13 Superv status</a> (see page <a href="#">136</a> ).	1073808909
	Supervision3	Bit 2 of <a href="#">06.13 Superv status</a> (see page <a href="#">136</a> ).	1073874445
	Const	Bit pointer setting (see <a href="#">Terms and abbreviations</a> on page <a href="#">115</a> ).	-
	Pointer		
14.14	DIO4 conf	Selects whether DIO4 is used as a digital output or input.	
	Output	DIO4 is used as a digital output.	0
	Input	DIO4 is used as a digital input.	1
14.15	DIO4 out src	Selects a drive signal to be connected to digital output DIO4 (when <a href="#">14.14 DIO4 conf</a> is set to <i>Output</i> ).	
	Ready	Bit 0 of <a href="#">06.01 Status word1</a> (see page <a href="#">133</a> ).	1073743361
	Enabled	Bit 1 of <a href="#">06.01 Status word1</a> (see page <a href="#">133</a> ).	1073808897
	Started	Bit 2 of <a href="#">06.01 Status word1</a> (see page <a href="#">133</a> ).	1073874433
	Running	Bit 3 of <a href="#">06.01 Status word1</a> (see page <a href="#">133</a> ).	1073939969
	Alarm	Bit 7 of <a href="#">06.01 Status word1</a> (see page <a href="#">133</a> ).	1074202113
	Ext2 active	Bit 8 of <a href="#">06.01 Status word1</a> (see page <a href="#">133</a> ).	1074267649
	Fault	Bit 10 of <a href="#">06.01 Status word1</a> (see page <a href="#">133</a> ).	1074398721
	Fault(-1)	Bit 12 of <a href="#">06.01 Status word1</a> (see page <a href="#">133</a> ).	1074529793
	Ready relay	Bit 2 of <a href="#">06.02 Status word2</a> (see page <a href="#">134</a> ).	1073874434
	RunningRelay	Bit 3 of <a href="#">06.02 Status word2</a> (see page <a href="#">134</a> ).	1073939970
	Ref running	Bit 4 of <a href="#">06.02 Status word2</a> (see page <a href="#">134</a> ).	1074005506
	Charge ready	Bit 9 of <a href="#">06.02 Status word2</a> (see page <a href="#">134</a> ).	1074333186
	Neg speed	Bit 0 of <a href="#">06.03 Speed ctrl stat</a> (see page <a href="#">135</a> ).	1073743363
	Zero speed	Bit 1 of <a href="#">06.03 Speed ctrl stat</a> (see page <a href="#">135</a> ).	1073808899

No.	Name/Value	Description	FbEq
	Above limit	Bit 2 of <a href="#">06.03 Speed ctrl stat</a> (see page <a href="#">135</a> ).	1073874435
	At setpoint	Bit 3 of <a href="#">06.03 Speed ctrl stat</a> (see page <a href="#">135</a> ).	1073939971
	Supervision1	Bit 0 of <a href="#">06.13 Superv status</a> (see page <a href="#">136</a> ).	1073743373
	Supervision2	Bit 1 of <a href="#">06.13 Superv status</a> (see page <a href="#">136</a> ).	1073808909
	Supervision3	Bit 2 of <a href="#">06.13 Superv status</a> (see page <a href="#">136</a> ).	1073874445
	Const	Bit pointer setting (see <a href="#">Terms and abbreviations</a> on page <a href="#">115</a> ).	-
	Pointer		
14.18	DIO5 conf	Selects whether DIO5 is used as a digital output or input.	
	Output	DIO5 is used as a digital output.	0
	Input	DIO5 is used as a digital input.	1
14.19	DIO5 out src	Selects a drive signal to be connected to digital output DIO5 (when <a href="#">14.18 DIO5 conf</a> is set to <a href="#">Output</a> ).	
	Ready	Bit 0 of <a href="#">06.01 Status word1</a> (see page <a href="#">133</a> ).	1073743361
	Enabled	Bit 1 of <a href="#">06.01 Status word1</a> (see page <a href="#">133</a> ).	1073808897
	Started	Bit 2 of <a href="#">06.01 Status word1</a> (see page <a href="#">133</a> ).	1073874433
	Running	Bit 3 of <a href="#">06.01 Status word1</a> (see page <a href="#">133</a> ).	1073939969
	Alarm	Bit 7 of <a href="#">06.01 Status word1</a> (see page <a href="#">133</a> ).	1074202113
	Ext2 active	Bit 8 of <a href="#">06.01 Status word1</a> (see page <a href="#">133</a> ).	1074267649
	Fault	Bit 10 of <a href="#">06.01 Status word1</a> (see page <a href="#">133</a> ).	1074398721
	Fault(-1)	Bit 12 of <a href="#">06.01 Status word1</a> (see page <a href="#">133</a> ).	1074529793
	Ready relay	Bit 2 of <a href="#">06.02 Status word2</a> (see page <a href="#">134</a> ).	1073874434
	RunningRelay	Bit 3 of <a href="#">06.02 Status word2</a> (see page <a href="#">134</a> ).	1073939970
	Ref running	Bit 4 of <a href="#">06.02 Status word2</a> (see page <a href="#">134</a> ).	1074005506
	Charge ready	Bit 9 of <a href="#">06.02 Status word2</a> (see page <a href="#">134</a> ).	1074333186
	Neg speed	Bit 0 of <a href="#">06.03 Speed ctrl stat</a> (see page <a href="#">135</a> ).	1073743363
	Zero speed	Bit 1 of <a href="#">06.03 Speed ctrl stat</a> (see page <a href="#">135</a> ).	1073808899
	Above limit	Bit 2 of <a href="#">06.03 Speed ctrl stat</a> (see page <a href="#">135</a> ).	1073874435
	At setpoint	Bit 3 of <a href="#">06.03 Speed ctrl stat</a> (see page <a href="#">135</a> ).	1073939971
	Supervision1	Bit 0 of <a href="#">06.13 Superv status</a> (see page <a href="#">136</a> ).	1073743373
	Supervision2	Bit 1 of <a href="#">06.13 Superv status</a> (see page <a href="#">136</a> ).	1073808909
	Supervision3	Bit 2 of <a href="#">06.13 Superv status</a> (see page <a href="#">136</a> ).	1073874445
	Const	Bit pointer setting (see <a href="#">Terms and abbreviations</a> on page <a href="#">115</a> ).	-
	Pointer		
14.22	DIO6 conf	Selects whether DIO6 is used as a digital output or input.	
	Output	DIO6 is used as a digital output.	0
	Input	DIO6 is used as a digital input.	1
14.23	DIO6 out src	Selects a drive signal to be connected to digital output DIO6 (when <a href="#">14.22 DIO6 conf</a> is set to <a href="#">Output</a> ).	
	Ready	Bit 0 of <a href="#">06.01 Status word1</a> (see page <a href="#">133</a> ).	1073743361
	Enabled	Bit 1 of <a href="#">06.01 Status word1</a> (see page <a href="#">133</a> ).	1073808897
	Started	Bit 2 of <a href="#">06.01 Status word1</a> (see page <a href="#">133</a> ).	1073874433
	Running	Bit 3 of <a href="#">06.01 Status word1</a> (see page <a href="#">133</a> ).	1073939969

## 164 Parameters

No.	Name/Value	Description	FbEq
	Alarm	Bit 7 of <a href="#">06.01 Status word1</a> (see page <a href="#">133</a> ).	1074202113
	Ext2 active	Bit 8 of <a href="#">06.01 Status word1</a> (see page <a href="#">133</a> ).	1074267649
	Fault	Bit 10 of <a href="#">06.01 Status word1</a> (see page <a href="#">133</a> ).	1074398721
	Fault(-1)	Bit 12 of <a href="#">06.01 Status word1</a> (see page <a href="#">133</a> ).	1074529793
	Ready relay	Bit 2 of <a href="#">06.02 Status word2</a> (see page <a href="#">134</a> ).	1073874434
	RunningRelay	Bit 3 of <a href="#">06.02 Status word2</a> (see page <a href="#">134</a> ).	1073939970
	Ref running	Bit 4 of <a href="#">06.02 Status word2</a> (see page <a href="#">134</a> ).	1074005506
	Charge ready	Bit 9 of <a href="#">06.02 Status word2</a> (see page <a href="#">134</a> ).	1074333186
	Neg speed	Bit 0 of <a href="#">06.03 Speed ctrl stat</a> (see page <a href="#">135</a> ).	1073743363
	Zero speed	Bit 1 of <a href="#">06.03 Speed ctrl stat</a> (see page <a href="#">135</a> ).	1073808899
	Above limit	Bit 2 of <a href="#">06.03 Speed ctrl stat</a> (see page <a href="#">135</a> ).	1073874435
	At setpoint	Bit 3 of <a href="#">06.03 Speed ctrl stat</a> (see page <a href="#">135</a> ).	1073939971
	Supervision1	Bit 0 of <a href="#">06.13 Superv status</a> (see page <a href="#">136</a> ).	1073743373
	Supervision2	Bit 1 of <a href="#">06.13 Superv status</a> (see page <a href="#">136</a> ).	1073808909
	Supervision3	Bit 2 of <a href="#">06.13 Superv status</a> (see page <a href="#">136</a> ).	1073874445
	Const	Bit pointer setting (see <a href="#">Terms and abbreviations</a> on page <a href="#">115</a> ).	-
	Pointer		
14.42	RO1 src	Selects a drive signal to be connected to relay output RO1.	
	Trad pump1	Bit 0 of <a href="#">05.02 Trad pump cmd</a> (see page <a href="#">131</a> ).	1073743106
	Ready	Bit 0 of <a href="#">06.01 Status word1</a> (see page <a href="#">133</a> ).	1073743361
	Enabled	Bit 1 of <a href="#">06.01 Status word1</a> (see page <a href="#">133</a> ).	1073808897
	Started	Bit 2 of <a href="#">06.01 Status word1</a> (see page <a href="#">133</a> ).	1073874433
	Running	Bit 3 of <a href="#">06.01 Status word1</a> (see page <a href="#">133</a> ).	1073939969
	Alarm	Bit 7 of <a href="#">06.01 Status word1</a> (see page <a href="#">133</a> ).	1074202113
	Ext2 active	Bit 8 of <a href="#">06.01 Status word1</a> (see page <a href="#">133</a> ).	1074267649
	Fault	Bit 10 of <a href="#">06.01 Status word1</a> (see page <a href="#">133</a> ).	1074398721
	Fault(-1)	Bit 12 of <a href="#">06.01 Status word1</a> (see page <a href="#">133</a> ).	1074529793
	Ready relay	Bit 2 of <a href="#">06.02 Status word2</a> (see page <a href="#">134</a> ).	1073874434
	RunningRelay	Bit 3 of <a href="#">06.02 Status word2</a> (see page <a href="#">134</a> ).	1073939970
	Ref running	Bit 4 of <a href="#">06.02 Status word2</a> (see page <a href="#">134</a> ).	1074005506
	Charge ready	Bit 9 of <a href="#">06.02 Status word2</a> (see page <a href="#">134</a> ).	1074333186
	Neg speed	Bit 0 of <a href="#">06.03 Speed ctrl stat</a> (see page <a href="#">135</a> ).	1073743363
	Zero speed	Bit 1 of <a href="#">06.03 Speed ctrl stat</a> (see page <a href="#">135</a> ).	1073808899
	Above limit	Bit 2 of <a href="#">06.03 Speed ctrl stat</a> (see page <a href="#">135</a> ).	1073874435
	At setpoint	Bit 3 of <a href="#">06.03 Speed ctrl stat</a> (see page <a href="#">135</a> ).	1073939971
	Supervision1	Bit 0 of <a href="#">06.13 Superv status</a> (see page <a href="#">136</a> ).	1073743373
	Supervision2	Bit 1 of <a href="#">06.13 Superv status</a> (see page <a href="#">136</a> ).	1073808909
	Supervision3	Bit 2 of <a href="#">06.13 Superv status</a> (see page <a href="#">136</a> ).	1073874445
	Const	Bit pointer setting (see <a href="#">Terms and abbreviations</a> on page <a href="#">115</a> ).	-
	Pointer		

No.	Name/Value	Description	FbEq
14.43	RO1 Ton	Defines the on (activation) delay for relay output RO1.	
<p style="text-align: center;"> <math>t_{On}</math>      <math>t_{Off}</math>                      <math>t_{On}</math>                      <math>t_{Off}</math> </p> <p style="text-align: center;"> <math>t_{On}</math>      <a href="#">14.43 RO1 Ton</a>  <math>t_{Off}</math>      <a href="#">14.44 RO1 Toff</a> </p>			
	0.0 ... 3000.0 s	On (activation) delay for RO1.	10 = 1 s
14.44	RO1 Toff	Defines the off (deactivation) delay for relay output RO1. See parameter <a href="#">14.43 RO1 Ton</a> .	
	0.0 ... 3000.0 s	Off (deactivation) delay for RO1.	10 = 1 s
14.45	RO2 src	Selects a drive signal to be connected to relay output RO2.	
	Trad pump2	Bit 1 of <a href="#">05.02 Trad pump cmd</a> (see page <a href="#">131</a> ).	1073808642
	Ready	Bit 0 of <a href="#">06.01 Status word1</a> (see page <a href="#">133</a> ).	1073743361
	Enabled	Bit 1 of <a href="#">06.01 Status word1</a> (see page <a href="#">133</a> ).	1073808897
	Started	Bit 2 of <a href="#">06.01 Status word1</a> (see page <a href="#">133</a> ).	1073874433
	Running	Bit 3 of <a href="#">06.01 Status word1</a> (see page <a href="#">133</a> ).	1073939969
	Alarm	Bit 7 of <a href="#">06.01 Status word1</a> (see page <a href="#">133</a> ).	1074202113
	Ext2 active	Bit 8 of <a href="#">06.01 Status word1</a> (see page <a href="#">133</a> ).	1074267649
	Fault	Bit 10 of <a href="#">06.01 Status word1</a> (see page <a href="#">133</a> ).	1074398721
	Fault(-1)	Bit 12 of <a href="#">06.01 Status word1</a> (see page <a href="#">133</a> ).	1074529793
	Ready relay	Bit 2 of <a href="#">06.02 Status word2</a> (see page <a href="#">134</a> ).	1073874434
	RunningRelay	Bit 3 of <a href="#">06.02 Status word2</a> (see page <a href="#">134</a> ).	1073939970
	Ref running	Bit 4 of <a href="#">06.02 Status word2</a> (see page <a href="#">134</a> ).	1074005506
	Charge ready	Bit 9 of <a href="#">06.02 Status word2</a> (see page <a href="#">134</a> ).	1074333186
	Neg speed	Bit 0 of <a href="#">06.03 Speed ctrl stat</a> (see page <a href="#">135</a> ).	1073743363
	Zero speed	Bit 1 of <a href="#">06.03 Speed ctrl stat</a> (see page <a href="#">135</a> ).	1073808899
	Above limit	Bit 2 of <a href="#">06.03 Speed ctrl stat</a> (see page <a href="#">135</a> ).	1073874435
	At setpoint	Bit 3 of <a href="#">06.03 Speed ctrl stat</a> (see page <a href="#">135</a> ).	1073939971
	Supervision1	Bit 0 of <a href="#">06.13 Superv status</a> (see page <a href="#">136</a> ).	1073743373
	Supervision2	Bit 1 of <a href="#">06.13 Superv status</a> (see page <a href="#">136</a> ).	1073808909
	Supervision3	Bit 2 of <a href="#">06.13 Superv status</a> (see page <a href="#">136</a> ).	1073874445
	Const	Bit pointer setting (see <a href="#">Terms and abbreviations</a> on page <a href="#">115</a> ).	-
	Pointer		

No.	Name/Value	Description	FbEq
14.48	RO3 src	Selects a drive signal to be connected to relay output RO3.	
	Trad pump3	Bit 2 of <a href="#">05.02 Trad pump cmd</a> (see page <a href="#">131</a> ).	1073874178
	Ready	Bit 0 of <a href="#">06.01 Status word1</a> (see page <a href="#">133</a> ).	1073743361
	Enabled	Bit 1 of <a href="#">06.01 Status word1</a> (see page <a href="#">133</a> ).	1073808897
	Started	Bit 2 of <a href="#">06.01 Status word1</a> (see page <a href="#">133</a> ).	1073874433
	Running	Bit 3 of <a href="#">06.01 Status word1</a> (see page <a href="#">133</a> ).	1073939969
	Alarm	Bit 7 of <a href="#">06.01 Status word1</a> (see page <a href="#">133</a> ).	1074202113
	Ext2 active	Bit 8 of <a href="#">06.01 Status word1</a> (see page <a href="#">133</a> ).	1074267649
	Fault	Bit 10 of <a href="#">06.01 Status word1</a> (see page <a href="#">133</a> ).	1074398721
	Fault(-1)	Bit 12 of <a href="#">06.01 Status word1</a> (see page <a href="#">133</a> ).	1074529793
	Ready relay	Bit 2 of <a href="#">06.02 Status word2</a> (see page <a href="#">134</a> ).	1073874434
	RunningRelay	Bit 3 of <a href="#">06.02 Status word2</a> (see page <a href="#">134</a> ).	1073939970
	Ref running	Bit 4 of <a href="#">06.02 Status word2</a> (see page <a href="#">134</a> ).	1074005506
	Charge ready	Bit 9 of <a href="#">06.02 Status word2</a> (see page <a href="#">134</a> ).	1074333186
	Neg speed	Bit 0 of <a href="#">06.03 Speed ctrl stat</a> (see page <a href="#">135</a> ).	1073743363
	Zero speed	Bit 1 of <a href="#">06.03 Speed ctrl stat</a> (see page <a href="#">135</a> ).	1073808899
	Above limit	Bit 2 of <a href="#">06.03 Speed ctrl stat</a> (see page <a href="#">135</a> ).	1073874435
	At setpoint	Bit 3 of <a href="#">06.03 Speed ctrl stat</a> (see page <a href="#">135</a> ).	1073939971
	Supervision1	Bit 0 of <a href="#">06.13 Superv status</a> (see page <a href="#">136</a> ).	1073743373
	Supervision2	Bit 1 of <a href="#">06.13 Superv status</a> (see page <a href="#">136</a> ).	1073808909
	Supervision3	Bit 2 of <a href="#">06.13 Superv status</a> (see page <a href="#">136</a> ).	1073874445
	Const Pointer	Bit pointer setting (see <a href="#">Terms and abbreviations</a> on page <a href="#">115</a> ).	-
14.51	RO4 src	Selects a drive signal to be connected to relay output RO4.	
	Trad pump4	Bit 3 of <a href="#">05.02 Trad pump cmd</a> (see page <a href="#">131</a> ).	1073939714
	Ready	Bit 0 of <a href="#">06.01 Status word1</a> (see page <a href="#">133</a> ).	1073743361
	Enabled	Bit 1 of <a href="#">06.01 Status word1</a> (see page <a href="#">133</a> ).	1073808897
	Started	Bit 2 of <a href="#">06.01 Status word1</a> (see page <a href="#">133</a> ).	1073874433
	Running	Bit 3 of <a href="#">06.01 Status word1</a> (see page <a href="#">133</a> ).	1073939969
	Alarm	Bit 7 of <a href="#">06.01 Status word1</a> (see page <a href="#">133</a> ).	1074202113
	Ext2 active	Bit 8 of <a href="#">06.01 Status word1</a> (see page <a href="#">133</a> ).	1074267649
	Fault	Bit 10 of <a href="#">06.01 Status word1</a> (see page <a href="#">133</a> ).	1074398721
	Fault(-1)	Bit 12 of <a href="#">06.01 Status word1</a> (see page <a href="#">133</a> ).	1074529793
	Ready relay	Bit 2 of <a href="#">06.02 Status word2</a> (see page <a href="#">134</a> ).	1073874434
	RunningRelay	Bit 3 of <a href="#">06.02 Status word2</a> (see page <a href="#">134</a> ).	1073939970
	Ref running	Bit 4 of <a href="#">06.02 Status word2</a> (see page <a href="#">134</a> ).	1074005506
	Charge ready	Bit 9 of <a href="#">06.02 Status word2</a> (see page <a href="#">134</a> ).	1074333186
	Neg speed	Bit 0 of <a href="#">06.03 Speed ctrl stat</a> (see page <a href="#">135</a> ).	1073743363
	Zero speed	Bit 1 of <a href="#">06.03 Speed ctrl stat</a> (see page <a href="#">135</a> ).	1073808899
	Above limit	Bit 2 of <a href="#">06.03 Speed ctrl stat</a> (see page <a href="#">135</a> ).	1073874435
	At setpoint	Bit 3 of <a href="#">06.03 Speed ctrl stat</a> (see page <a href="#">135</a> ).	1073939971



No.	Name/Value	Description	FbEq
	Supervision1	Bit 0 of <a href="#">06.13 Superv status</a> (see page <a href="#">136</a> ).	1073743373
	Supervision2	Bit 1 of <a href="#">06.13 Superv status</a> (see page <a href="#">136</a> ).	1073808909
	Supervision3	Bit 2 of <a href="#">06.13 Superv status</a> (see page <a href="#">136</a> ).	1073874445
	Const	Bit pointer setting (see <a href="#">Terms and abbreviations</a> on page <a href="#">115</a> ).	-
	Pointer		
14.54	RO5 src	Selects a drive signal to be connected to relay output RO5.	
	Trad pump5	Bit 4 of <a href="#">05.02 Trad pump cmd</a> (see page <a href="#">131</a> ).	1074005250
	Ready	Bit 0 of <a href="#">06.01 Status word1</a> (see page <a href="#">133</a> ).	1073743361
	Enabled	Bit 1 of <a href="#">06.01 Status word1</a> (see page <a href="#">133</a> ).	1073808897
	Started	Bit 2 of <a href="#">06.01 Status word1</a> (see page <a href="#">133</a> ).	1073874433
	Running	Bit 3 of <a href="#">06.01 Status word1</a> (see page <a href="#">133</a> ).	1073939969
	Alarm	Bit 7 of <a href="#">06.01 Status word1</a> (see page <a href="#">133</a> ).	1074202113
	Ext2 active	Bit 8 of <a href="#">06.01 Status word1</a> (see page <a href="#">133</a> ).	1074267649
	Fault	Bit 10 of <a href="#">06.01 Status word1</a> (see page <a href="#">133</a> ).	1074398721
	Fault(-1)	Bit 12 of <a href="#">06.01 Status word1</a> (see page <a href="#">133</a> ).	1074529793
	Ready relay	Bit 2 of <a href="#">06.02 Status word2</a> (see page <a href="#">134</a> ).	1073874434
	RunningRelay	Bit 3 of <a href="#">06.02 Status word2</a> (see page <a href="#">134</a> ).	1073939970
	Ref running	Bit 4 of <a href="#">06.02 Status word2</a> (see page <a href="#">134</a> ).	1074005506
	Charge ready	Bit 9 of <a href="#">06.02 Status word2</a> (see page <a href="#">134</a> ).	1074333186
	Neg speed	Bit 0 of <a href="#">06.03 Speed ctrl stat</a> (see page <a href="#">135</a> ).	1073743363
	Zero speed	Bit 1 of <a href="#">06.03 Speed ctrl stat</a> (see page <a href="#">135</a> ).	1073808899
	Above limit	Bit 2 of <a href="#">06.03 Speed ctrl stat</a> (see page <a href="#">135</a> ).	1073874435
	At setpoint	Bit 3 of <a href="#">06.03 Speed ctrl stat</a> (see page <a href="#">135</a> ).	1073939971
	Supervision1	Bit 0 of <a href="#">06.13 Superv status</a> (see page <a href="#">136</a> ).	1073743373
	Supervision2	Bit 1 of <a href="#">06.13 Superv status</a> (see page <a href="#">136</a> ).	1073808909
	Supervision3	Bit 2 of <a href="#">06.13 Superv status</a> (see page <a href="#">136</a> ).	1073874445
	Const	Bit pointer setting (see <a href="#">Terms and abbreviations</a> on page <a href="#">115</a> ).	-
	Pointer		

No.	Name/Value	Description	FbEq
14.57	Freq in max	<p>Defines the maximum input frequency for DIO1 when parameter <a href="#">14.02 DIO1 conf</a> is set to <i>Freq input</i>. The frequency signal connected to DIO1 is scaled into an internal signal (<a href="#">02.20 Freq in</a>) by parameters <a href="#">14.57... 14.60</a> as follows:</p>	
	3 ... 32768 Hz	DIO1 maximum frequency.	1 = 1 Hz
14.58	Freq in min	Defines the minimum input frequency for DIO1 when parameter <a href="#">14.02 DIO1 conf</a> is set to <i>Freq input</i> . See parameter <a href="#">14.57 Freq in max</a> .	
	3 ... 32768 Hz	DIO1 minimum frequency.	1 = 1 Hz
14.59	Freq in max scal	Defines the value that corresponds to the maximum input frequency defined by parameter <a href="#">14.57 Freq in max</a> . See parameter <a href="#">14.57 Freq in max</a> .	
	-32768 ... 32768	Scaled value corresponding to DIO1 maximum frequency.	1 = 1
14.60	Freq in min scal	Defines the value that corresponds to the minimum input frequency defined by parameter <a href="#">14.58 Freq in min</a> . See diagram at parameter <a href="#">14.57 Freq in max</a> .	
	-32768 ... 32768	Scaled value corresponding to DIO1 minimum frequency.	1 = 1
14.61	Freq out src	Selects a drive signal to be connected to frequency output DIO2 (when <a href="#">14.06 DIO2 conf</a> is set to <i>Freq output</i> ).	
		Value pointer setting (see <a href="#">Terms and abbreviations</a> on page <a href="#">115</a> ).	-



No.	Name/Value	Description	FbEq
14.62	Freq out max src	<p>When <a href="#">14.06 DIO2 conf</a> is set to <i>Freq output</i>, defines the real value of the signal (selected by parameter <a href="#">14.61 Freq out src</a>) that corresponds to the maximum DIO2 frequency output value (defined by parameter <a href="#">14.64 Freq out max sca</a>).</p> <p>The figure contains two graphs. Both graphs have <math>f_{DIO2}</math> (Hz) on the vertical axis and 'Signal (real) selected by par. 14.61' on the horizontal axis. The top graph shows a piecewise linear function that is constant at 14.65 Hz for signal values up to 14.63, then increases linearly to 14.64 Hz at signal value 14.62, and remains constant at 14.64 Hz for higher signal values. The bottom graph shows a piecewise linear function that is constant at 14.64 Hz for signal values up to 14.62, then decreases linearly to 14.65 Hz at signal value 14.63, and remains constant at 14.65 Hz for higher signal values.</p>	
	0 ... 32768	Real signal value corresponding to maximum DIO2 output frequency.	1 = 1
14.63	Freq out min src	When <a href="#">14.06 DIO2 conf</a> is set to <i>Freq output</i> , defines the real value of the signal (selected by parameter <a href="#">14.61 Freq out src</a> ) that corresponds to the minimum DIO2 frequency output value (defined by parameter <a href="#">14.65 Freq out min sca</a> ).	
	0 ... 32768	Real signal value corresponding to minimum DIO2 output frequency.	1 = 1
14.64	Freq out max sca	When <a href="#">14.06 DIO2 conf</a> is set to <i>Freq output</i> , defines the maximum DIO2 output frequency.	
	3 ... 32768 Hz	Maximum DIO2 output frequency.	1 = 1 Hz
14.65	Freq out min sca	When <a href="#">14.06 DIO2 conf</a> is set to <i>Freq output</i> , defines the minimum DIO2 output frequency.	
	3 ... 32768 Hz	Minimum DIO2 output frequency.	1 = 1 Hz
14.66	RO6 src	Selects a drive signal to be connected to relay output RO6.	
	Trad pump6	Bit 5 of <a href="#">05.02 Trad pump cmd</a> (see page <a href="#">131</a> ).	1074070786
	Ready	Bit 0 of <a href="#">06.01 Status word1</a> (see page <a href="#">133</a> ).	1073743361
	Enabled	Bit 1 of <a href="#">06.01 Status word1</a> (see page <a href="#">133</a> ).	1073808897
	Started	Bit 2 of <a href="#">06.01 Status word1</a> (see page <a href="#">133</a> ).	1073874433

## 170 Parameters

No.	Name/Value	Description	FbEq
	Running	Bit 3 of <a href="#">06.01 Status word1</a> (see page <a href="#">133</a> ).	1073939969
	Alarm	Bit 7 of <a href="#">06.01 Status word1</a> (see page <a href="#">133</a> ).	1074202113
	Ext2 active	Bit 8 of <a href="#">06.01 Status word1</a> (see page <a href="#">133</a> ).	1074267649
	Fault	Bit 10 of <a href="#">06.01 Status word1</a> (see page <a href="#">133</a> ).	1074398721
	Fault(-1)	Bit 12 of <a href="#">06.01 Status word1</a> (see page <a href="#">133</a> ).	1074529793
	Ready relay	Bit 2 of <a href="#">06.02 Status word2</a> (see page <a href="#">134</a> ).	1073874434
	RunningRelay	Bit 3 of <a href="#">06.02 Status word2</a> (see page <a href="#">134</a> ).	1073939970
	Ref running	Bit 4 of <a href="#">06.02 Status word2</a> (see page <a href="#">134</a> ).	1074005506
	Charge ready	Bit 9 of <a href="#">06.02 Status word2</a> (see page <a href="#">134</a> ).	1074333186
	Neg speed	Bit 0 of <a href="#">06.03 Speed ctrl stat</a> (see page <a href="#">135</a> ).	1073743363
	Zero speed	Bit 1 of <a href="#">06.03 Speed ctrl stat</a> (see page <a href="#">135</a> ).	1073808899
	Above limit	Bit 2 of <a href="#">06.03 Speed ctrl stat</a> (see page <a href="#">135</a> ).	1073874435
	At setpoint	Bit 3 of <a href="#">06.03 Speed ctrl stat</a> (see page <a href="#">135</a> ).	1073939971
	Supervision1	Bit 0 of <a href="#">06.13 Superv status</a> (see page <a href="#">136</a> ).	1073743373
	Supervision2	Bit 1 of <a href="#">06.13 Superv status</a> (see page <a href="#">136</a> ).	1073808909
	Supervision3	Bit 2 of <a href="#">06.13 Superv status</a> (see page <a href="#">136</a> ).	1073874445
	Const	Bit pointer setting (see <a href="#">Terms and abbreviations</a> on page <a href="#">115</a> ).	-
	Pointer		
14.72	DIO invert mask	Inverts status of digital input/outputs as reported by <a href="#">02.03 DIO status</a> .	

Bit	Name
0	1 = Invert DIO1
1	1 = Invert DIO2
2	1 = Invert DIO3 (on optional FIO-01 I/O Extension)
3	1 = Invert DIO4 (on optional FIO-01 I/O Extension)
4	1 = Invert DIO5 (on optional FIO-01 I/O Extension)
5	1 = Invert DIO6 (on optional FIO-01 I/O Extension)
6	1 = Invert DIO7 (on optional FIO-01 I/O Extension)
7	1 = Invert DIO8 (on optional FIO-01 I/O Extension)
8	1 = Invert DIO9 (on optional FIO-01 I/O Extension)
9	1 = Invert DIO10 (on optional FIO-01 I/O Extension)

15 Analogue outputs		Selection and processing of actual signals to be indicated through the analog outputs. See also section <a href="#">Programmable analog outputs</a> on page <a href="#">70</a> .	
15.01	AO1 src	Selects a drive signal to be connected to analog output AO1.	
	Speed rpm	<a href="#">01.01 Motor speed rpm</a> (see page <a href="#">118</a> ).	1073742081
	Speed %	<a href="#">01.02 Motor speed %</a> (see page <a href="#">118</a> ).	1073742082
	Frequency	<a href="#">01.03 Output frequency</a> (see page <a href="#">118</a> ).	1073742083
	Current	<a href="#">01.04 Motor current</a> (see page <a href="#">118</a> ).	1073742084
	Current %	<a href="#">01.05 Motor current %</a> (see page <a href="#">118</a> ).	1073742085
	Torque	<a href="#">01.06 Motor torque</a> (see page <a href="#">118</a> ).	1073742086
	Dc-voltage	<a href="#">01.07 Dc-voltage</a> (see page <a href="#">118</a> ).	1073742087

No.	Name/Value	Description	FbEq
	Power inu	<a href="#">01.22 Power inu out</a> (see page 118).	1073742102
	Power motor	<a href="#">01.23 Motor power</a> (see page 118).	1073742103
	SpRef unramp	<a href="#">03.03 SpeedRef unramp</a> (see page 129).	1073742595
	SpRef ramped	<a href="#">03.05 SpeedRef ramped</a> (see page 129).	1073742597
	SpRef used	<a href="#">03.06 SpeedRef used</a> (see page 129).	1073742598
	TorqRef used	<a href="#">03.14 Torq ref used</a> (see page 129).	1073742606
	Proc PID out	<a href="#">04.05 Process PID out</a> (see page 129).	1073742853
	Process act%	<a href="#">04.22 Act val %</a> (see page 130).	1073742870
	Pointer	Value pointer setting (see <a href="#">Terms and abbreviations</a> on page 115).	-
15.02	AO1 filt time	<p>Defines the filtering time constant for analog output AO1.</p>  $O = I \times (1 - e^{-t/T})$ <p> I = filter input (step)  O = filter output  t = time  T = filter time constant </p>	
	0.000 ... 30.000 s	Filter time constant.	1000 = 1 s
15.03	AO1 out max	Defines the maximum output value for analog output AO1.	
	0.000 ... 22.700 mA	Maximum AO1 output value.	1000 = 1 mA
15.04	AO1 out min	Defines the minimum output value for analog output AO1.	
	0.000 ... 22.700 mA	Minimum AO1 output value.	1000 = 1 mA

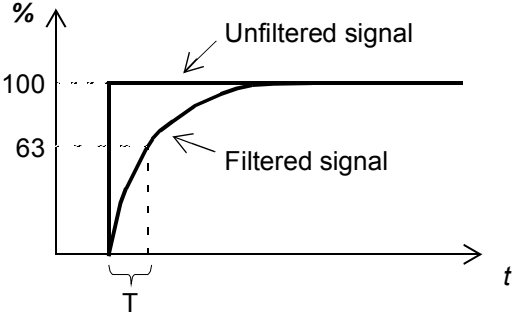
No.	Name/Value	Description	FbEq
15.05	AO1 src max	<p>Defines the real value of the signal (selected by parameter <a href="#">15.01 AO1 src</a>) that corresponds to the maximum AO1 output value (defined by parameter <a href="#">15.03 AO1 out max</a>).</p>  <p>The figure contains two graphs. Both graphs have <math>I_{AO1}</math> (mA) on the vertical axis and 'Signal (real) selected by par. 15.01' on the horizontal axis. The top graph shows a signal value increasing from 15.06 to 15.05, with the output current <math>I_{AO1}</math> increasing from 15.04 mA to 15.03 mA. The bottom graph shows a signal value increasing from 15.05 to 15.06, with the output current <math>I_{AO1}</math> decreasing from 15.03 mA to 15.04 mA.</p>	
	-32768.000 ... 32768.000	Real signal value corresponding to maximum AO1 output value.	1000 = 1
15.06	AO1 src min	Defines the real value of the signal (selected by parameter <a href="#">15.01 AO1 src</a> ) that corresponds to the minimum AO1 output value (defined by parameter <a href="#">15.04 AO1 out min</a> ). See parameter <a href="#">15.05 AO1 src max</a> .	
	-32768.000 ... 32768.000	Real signal value corresponding to minimum AO1 output value.	1000 = 1
15.07	AO2 src	Selects a drive signal to be connected to analog output AO2.	
	Speed rpm	<a href="#">01.01 Motor speed rpm</a> (see page <a href="#">118</a> ).	1073742081
	Speed %	<a href="#">01.02 Motor speed %</a> (see page <a href="#">118</a> ).	1073742082
	Frequency	<a href="#">01.03 Output frequency</a> (see page <a href="#">118</a> ).	1073742083
	Current	<a href="#">01.04 Motor current</a> (see page <a href="#">118</a> ).	1073742084
	Current %	<a href="#">01.05 Motor current %</a> (see page <a href="#">118</a> ).	1073742085
	Torque	<a href="#">01.06 Motor torque</a> (see page <a href="#">118</a> ).	1073742086
	Dc-voltage	<a href="#">01.07 Dc-voltage</a> (see page <a href="#">118</a> ).	1073742087
	Power inu	<a href="#">01.22 Power inu out</a> (see page <a href="#">118</a> ).	1073742102
	Power motor	<a href="#">01.23 Motor power</a> (see page <a href="#">118</a> ).	1073742103
	SpRef unramp	<a href="#">03.03 SpeedRef unramp</a> (see page <a href="#">129</a> ).	1073742595
	SpRef ramped	<a href="#">03.05 SpeedRef ramped</a> (see page <a href="#">129</a> ).	1073742597

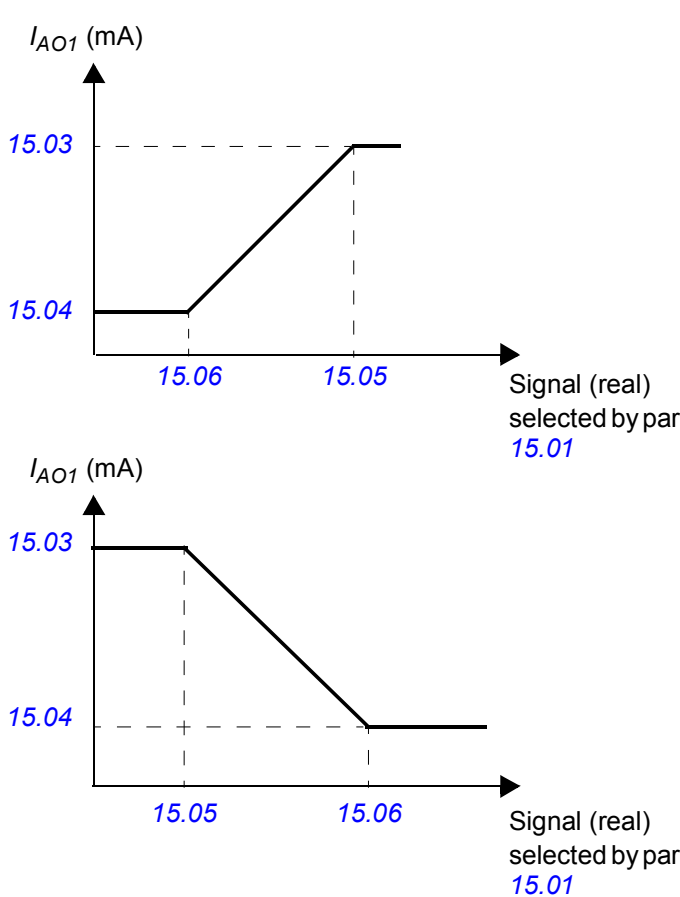
No.	Name/Value	Description	FbEq
	SpRef used	<a href="#">03.06 SpeedRef used</a> (see page 129).	1073742598
	TorqRef used	<a href="#">03.14 Torq ref used</a> (see page 129).	1073742606
	Proc PID out	<a href="#">04.05 Process PID out</a> (see page 129).	1073742853
	Process act%	<a href="#">04.22 Act val %</a> (see page 130).	1073742870
	Pointer	Value pointer setting (see <a href="#">Terms and abbreviations</a> on page 115).	-
15.08	AO2 filt time	Defines the filtering time constant for analog output AO2. See parameter <a href="#">15.02 AO1 filt time</a> .	
	0.000 ... 30.000 s	Filter time constant.	1000 = 1 s
15.09	AO2 out max	Defines the maximum output value for analog output AO2.	
	-10.000 ... 10.000 V	Maximum AO2 output value.	1000 = 1 V
15.10	AO2 out min	Defines the minimum output value for analog output AO2.	
	-10.000 ... 10.000 V	Minimum AO2 output value.	1000 = 1 mA
15.11	AO2 src max	Defines the real value of the signal (selected by parameter <a href="#">15.07 AO2 src</a> ) that corresponds to the maximum AO2 output value (defined by parameter <a href="#">15.09 AO2 out max</a> ).	
		<p>The figure consists of two graphs. Both graphs have <math>I_{AO2}</math> (V) on the vertical axis. The horizontal axis is labeled 'Signal (real) selected by par. 15.07'.  The top graph shows a signal value increasing from 15.10 to 15.11. The output current <math>I_{AO2}</math> starts at a constant value of 15.10, then increases linearly to 15.09 at signal value 15.11, and remains constant at 15.09 for higher signal values.  The bottom graph shows a signal value increasing from 15.11 to 15.12. The output current <math>I_{AO2}</math> starts at a constant value of 15.09, then decreases linearly to 15.10 at signal value 15.12, and remains constant at 15.10 for higher signal values.</p>	
	-32768.000 ... 32768.000	Real signal value corresponding to maximum AO2 output value.	1000 = 1

## 174 Parameters

No.	Name/Value	Description	FbEq
15.12	AO2 src min	Defines the real value of the signal (selected by parameter <a href="#">15.07 AO2 src</a> ) that corresponds to the minimum AO2 output value (defined by parameter <a href="#">15.10 AO2 out min</a> ). See parameter <a href="#">15.11 AO2 src max</a> .	
	-32768.000 ... 32768.000	Real signal value corresponding to minimum AO2 output value.	1000 = 1
15.13	AO3 src	Selects a drive signal to be connected to analog output AO3.	
	Speed rpm	<a href="#">01.01 Motor speed rpm</a> (see page <a href="#">118</a> ).	1073742081
	Speed %	<a href="#">01.02 Motor speed %</a> (see page <a href="#">118</a> ).	1073742082
	Frequency	<a href="#">01.03 Output frequency</a> (see page <a href="#">118</a> ).	1073742083
	Current	<a href="#">01.04 Motor current</a> (see page <a href="#">118</a> ).	1073742084
	Current %	<a href="#">01.05 Motor current %</a> (see page <a href="#">118</a> ).	1073742085
	Torque	<a href="#">01.06 Motor torque</a> (see page <a href="#">118</a> ).	1073742086
	Dc-voltage	<a href="#">01.07 Dc-voltage</a> (see page <a href="#">118</a> ).	1073742087
	Power inu	<a href="#">01.22 Power inu out</a> (see page <a href="#">118</a> ).	1073742102
	Power motor	<a href="#">01.23 Motor power</a> (see page <a href="#">118</a> ).	1073742103
	SpRef unramp	<a href="#">03.03 SpeedRef unramp</a> (see page <a href="#">129</a> ).	1073742595
	SpRef ramped	<a href="#">03.05 SpeedRef ramped</a> (see page <a href="#">129</a> ).	1073742597
	SpRef used	<a href="#">03.06 SpeedRef used</a> (see page <a href="#">129</a> ).	1073742598
	TorqRef used	<a href="#">03.14 Torq ref used</a> (see page <a href="#">129</a> ).	1073742606
	Proc PID out	<a href="#">04.05 Process PID out</a> (see page <a href="#">129</a> ).	1073742853
	Process act%	<a href="#">04.22 Act val %</a> (see page <a href="#">130</a> ).	1073742870
	Pointer	Value pointer setting (see <a href="#">Terms and abbreviations</a> on page <a href="#">115</a> ).	-
15.14	AO3 filt time	Defines the filtering time constant for analog output AO3. See parameter <a href="#">15.02 AO1 filt time</a> .	
	0.000 ... 30.000 s	Filter time constant.	1000 = 1 s
15.15	AO3 out max	Defines the maximum output value for analog output AO3.	
	0.000 ... 22.700 mA	Maximum AO3 output value.	1000 = 1 mA
15.16	AO3 out min	Defines the minimum output value for analog output AO3.	
	0.000 ... 22.700 mA	Minimum AO3 output value.	1000 = 1 mA

No.	Name/Value	Description	FbEq
15.17	AO3 src max	<p>Defines the real value of the signal (selected by parameter <a href="#">15.13 AO3 src</a>) that corresponds to the maximum AO3 output value (defined by parameter <a href="#">15.15 AO3 out max</a>).</p> <p>The top graph shows <math>I_{AO3}</math> (mA) on the y-axis and Signal (real) selected by par. 15.13 on the x-axis. The signal is constant at 15.16 until parameter 15.18, then increases linearly to 15.15 at parameter 15.17, and remains constant at 15.15 thereafter.</p> <p>The bottom graph shows <math>I_{AO3}</math> (mA) on the y-axis and Signal (real) selected by par. 15.13 on the x-axis. The signal is constant at 15.15 until parameter 15.17, then decreases linearly to 15.16 at parameter 15.18, and remains constant at 15.16 thereafter.</p>	
	-32768.000 ... 32768.000	Real signal value corresponding to maximum AO3 output value.	1000 = 1
15.18	AO3 src min	<p>Defines the real value of the signal (selected by parameter <a href="#">15.13 AO3 src</a>) that corresponds to the minimum AO3 output value (defined by parameter <a href="#">15.16 AO3 out min</a>). See parameter <a href="#">15.17 AO3 src max</a>.</p>	
	-32768.000 ... 32768.000	Real signal value corresponding to minimum AO3 output value.	1000 = 1
15.25	AO ctrl word	Defines whether the signs of the sources connected to analog outputs AO1 and AO2 are considered or not.	
<b>Bit</b>	<b>Name</b>	<b>Information</b>	
0	AO1 func	0 = In signed: Sign of AO1 source is taken into account. 1 = In absolute: Absolute value of AO1 source is used.	
1	AO2 func	0 = In signed: Sign of AO2 source is taken into account. 1 = In absolute: Absolute value of AO2 source is used.	

No.	Name/Value	Description	FbEq
15.30	AO calibration	<p>Activates a calibration function that can be used to improve the accuracy of analog outputs.</p> <p>Make the following preparations before activation:</p> <ul style="list-style-type: none"> <li>• Connect a wire between the analog output to be calibrated and the corresponding analog input, for example, between AO1 and AI1, or AO2 and AI2.</li> <li>• Set the analog input to current using the jumper on the control unit. (A reboot is needed to validate changes.)</li> </ul> <p>The results of the calibration are saved to the memory unit and used automatically until cleared by a reset selection of this parameter.</p>	
	No action	Normal operation. The parameter automatically reverts to this setting.	0
	AO1 calib.	Calibrate analog output AO1.	1
	AO2 calib.	Calibrate analog output AO2.	2
	AO1 reset	Reset the previous calibration of analog output AO1.	3
	AO2 reset	Reset the previous calibration of analog output AO2.	4
<b>16 System</b>		Local lock and parameter lock settings; parameter restore; user parameter set load/save; parameter change log reset; parameter list settings; unit of power selection; application macro display.	
16.01	Local lock	<p>Selects the source for disabling local control (Take/Release button in the PC tool, LOC/REM key of the panel).</p> <p>0 = Local control enabled. 1 = Local control disabled.</p> <p> <b>WARNING!</b> Before activating, ensure that the control panel is not needed for stopping the drive!</p>	
	Const	Bit pointer setting (see <a href="#">Terms and abbreviations</a> on page 115).	-
	Pointer		
16.02	Parameter lock	Selects the state of the parameter lock. The lock prevents parameter changing.	
	Locked	Locked. Parameter values cannot be changed from the control panel. The lock can be opened by entering the valid code into parameter <a href="#">16.03 Pass code</a> .	0
	Open	The lock is open. Parameter values can be changed.	1
	Not saved	The lock is open. Parameter values can be changed, but the changes will not be stored at power switch-off.	2
16.03	Pass code	<p>Selects the pass code for the parameter lock (see parameter <a href="#">16.02 Parameter lock</a>).</p> <p>After entering 358 at this parameter, parameter <a href="#">16.02 Parameter lock</a> can be adjusted. The value reverts back to 0 automatically.</p>	
	0 ... 2147483647	Pass code for parameter lock.	1 = 1
16.04	Param restore	<p>Restores the original settings of the application, i.e. parameter factory default values.</p> <p><b>Note:</b> This parameter cannot be changed while the drive is running.</p>	
	Done	Restoring is completed.	0



No.	Name/Value	Description	FbEq
	Restore defs	All parameter values are restored to default values, except motor data, ID run results, and fieldbus adapter and drive-to-drive link configuration data. <b>Note:</b> After restoring, you need to reselect the appropriate application macro by launching the Application macro assistant available through the control panel.	1
	Clear all	All parameter values are restored to default values, including motor data, ID run results, and fieldbus adapter and drive-to-drive link configuration data. PC tool communication is interrupted during the restoring. Drive CPU is re-booted after the restoring is completed.	2
16.07	Param save	Saves the valid parameter values to the permanent memory. <b>Note:</b> A new parameter value is saved automatically when changed from the PC tool or panel but not when altered through a fieldbus adapter connection.	
	Done	Save completed.	0
	Save	Save in progress.	1
16.09	User set sel	Enables the saving and restoring of up to four custom sets of parameter settings. The set that was in use before powering down the drive is in use after the next power-up. <b>Notes:</b> <ul style="list-style-type: none"> <li>Fieldbus adapter parameters (groups 50...53) are not part of user parameter sets.</li> <li>Any parameter changes made after loading a set are not automatically stored – they must be saved using this parameter.</li> </ul>	
	No request	Load or save operation complete; normal operation.	1
	Load set 1	Load user parameter set 1.	2
	Load set 2	Load user parameter set 2.	3
	Load set 3	Load user parameter set 3.	4
	Load set 4	Load user parameter set 4.	5
	Save set 1	Save user parameter set 1.	6
	Save set 2	Save user parameter set 2.	7
	Save set 3	Save user parameter set 3.	8
	Save set 4	Save user parameter set 4.	9
	IO mode	Load user parameter set using parameters <a href="#">16.11 User IO sel lo</a> and <a href="#">16.12 User IO sel hi</a> .	10
16.10	User set log	Shows the status of the user parameter sets (see parameter <a href="#">16.09 User set sel</a> ). Read-only.	
	N/A	No user sets have been saved.	0
	Loading	A user set is being loaded.	1
	Saving	A user set is being saved.	2
	Faulted	Invalid or empty parameter set.	4
	Set1 IO act	User parameter set 1 has been selected by parameters <a href="#">16.11 User IO sel lo</a> and <a href="#">16.12 User IO sel hi</a> .	8
	Set2 IO act	User parameter set 2 has been selected by parameters <a href="#">16.11 User IO sel lo</a> and <a href="#">16.12 User IO sel hi</a> .	16

## 178 Parameters

No.	Name/Value	Description	FbEq															
	Set3 IO act	User parameter set 3 has been selected by parameters <a href="#">16.11 User IO sel lo</a> and <a href="#">16.12 User IO sel hi</a> .	32															
	Set4 IO act	User parameter set 4 has been selected by parameters <a href="#">16.11 User IO sel lo</a> and <a href="#">16.12 User IO sel hi</a> .	64															
	Set1 par act	User parameter set 1 has been loaded using parameter <a href="#">16.09 User set sel</a> .	128															
	Set2 par act	User parameter set 2 has been loaded using parameter <a href="#">16.09 User set sel</a> .	256															
	Set3 par act	User parameter set 3 has been loaded using parameter <a href="#">16.09 User set sel</a> .	512															
	Set4 par act	User parameter set 4 has been loaded using parameter <a href="#">16.09 User set sel</a> .	1024															
16.11	User IO sel lo	<p>When parameter <a href="#">16.09 User set sel</a> is set to <i>IO mode</i>, selects the user parameter set together with parameter <a href="#">16.12 User IO sel hi</a>. The status of the source defined by this parameter and parameter <a href="#">16.12</a> select the user parameter set as follows:</p> <table border="1"> <thead> <tr> <th>Status of source defined by par. <a href="#">16.11</a></th> <th>Status of source defined by par. <a href="#">16.12</a></th> <th>User parameter set selected</th> </tr> </thead> <tbody> <tr> <td>FALSE</td> <td>FALSE</td> <td>Set 1</td> </tr> <tr> <td>TRUE</td> <td>FALSE</td> <td>Set 2</td> </tr> <tr> <td>FALSE</td> <td>TRUE</td> <td>Set 3</td> </tr> <tr> <td>TRUE</td> <td>TRUE</td> <td>Set 4</td> </tr> </tbody> </table>	Status of source defined by par. <a href="#">16.11</a>	Status of source defined by par. <a href="#">16.12</a>	User parameter set selected	FALSE	FALSE	Set 1	TRUE	FALSE	Set 2	FALSE	TRUE	Set 3	TRUE	TRUE	Set 4	
Status of source defined by par. <a href="#">16.11</a>	Status of source defined by par. <a href="#">16.12</a>	User parameter set selected																
FALSE	FALSE	Set 1																
TRUE	FALSE	Set 2																
FALSE	TRUE	Set 3																
TRUE	TRUE	Set 4																
	Const	Bit pointer setting (see <a href="#">Terms and abbreviations</a> on page <a href="#">115</a> ).	-															
	Pointer																	
16.12	User IO sel hi	See parameter <a href="#">16.11 User IO sel lo</a> .																
	Const	Bit pointer setting (see <a href="#">Terms and abbreviations</a> on page <a href="#">115</a> ).	-															
	Pointer																	
16.14	Reset ChgParLog	Resets the log of latest parameter changes.																
	Done	Reset not requested (normal operation).	0															
	Reset	Reset log of latest parameter changes. The value reverts automatically to <i>Done</i> .	1															
16.16	Menu set active	Shows which parameter list is active. Parameter lists determine which parameters are displayed. See also parameter <a href="#">16.21 Menu selection</a> .																
	None	No specific parameter list is active.	0															
	Single short	A selective list of parameters relevant to the single pump (factory default) application macro is displayed.	1															
	Single long	A more comprehensive list of parameters relevant to the single pump (factory default) application macro is displayed.	2															
	Trad short	A selective list of parameters relevant to the traditional pump control application macro is displayed.	3															
	Trad long	A more comprehensive list of parameters relevant to the traditional pump control application macro is displayed.	4															

No.	Name/Value	Description	FbEq
	Ext short	A selective list of parameters relevant to the external control application macro is displayed.	5
	Ext long	A more comprehensive list of parameters relevant to the external control application macro is displayed.	6
	H/A short	A selective list of parameters relevant to the Hand/Auto control application macro is displayed.	7
	H/A long	A more comprehensive list of parameters relevant to the Hand/Auto control application macro is displayed.	8
	Level short	A selective list of parameters relevant to the Level control application macro (single-pump) is displayed.	9
	Level long	A more comprehensive list of parameters relevant to the Level control application macro (single-pump) is displayed.	10
	M lvi short	A selective list of parameters relevant to the Level control application macro (multipump) is displayed.	11
	M lvi long	A more comprehensive list of parameters relevant to the Level control application macro (multipump) is displayed.	12
	M pump short	A selective list of parameters relevant to the Multipump control application macro (single-pump) is displayed.	13
	M pump long	A more comprehensive list of parameters relevant to the Multipump control application macro (single-pump) is displayed.	14
	Full	All parameters are displayed.	15
16.17	Power unit	Selects the unit of power for parameters such as <a href="#">01.22 Power inu out</a> , <a href="#">01.23 Motor power</a> and <a href="#">99.10 Mot nom power</a> .	
	kW	Kilowatt.	0
	hp	Horsepower.	1
16.18	Fan ctrl mode	Selects the fan control mode. Available in frame sizes A to D.	
	Normal	Control mode is based on the modulator ON/OFF status.	0
	Force OFF	Fan is always off.	1
	Force ON	Fan is always on.	2
	Advanced	Control mode is based on the measured temperatures of the power stage and interface board.	3
16.20	Macro Read Only	Shows which application macro is currently selected. For more information, see chapter <a href="#">Application macros</a> (page 93). <b>Note:</b> Changing the value of this parameter does not change the current application macro. To change the application macro, use the Application macro assistant available through the control panel instead.	
	Factory def	Factory default macro.	0
	Ext ctrl	External control macro.	1
	Trad ctrl	Traditional pump control macro.	2
	Hand/Auto	Hand/Auto macro.	3
	Level ctrl	Level control macro (for a single pump).	4
	Multi level	Level control macro (for multiple pumps).	5
	Multi pump	Multipump control macro.	6
16.21	Menu selection	Loads a short, long or full parameter list.	

No.	Name/Value	Description	FbEq
	Short	Only a selective list of parameters will be displayed.	0
	Long	Only the parameters relevant to the current application macro are displayed.	1
	Full	All parameters are displayed, including those not relevant to the current application macro.	2
16.22	Drive boot	Reboots the drive control unit.	
	No action	Reboot not requested.	0
	Reboot drive	Reboot the drive control unit.	1
<b>19 Speed calculation</b>		Speed scaling, feedback and supervision settings.	
19.01	Speed scaling	Defines the terminal speed value used in acceleration and the initial speed value used in deceleration (see parameter group <a href="#">22 Speed ref ramp</a> ). Also defines the rpm value that corresponds to 20000 for fieldbus communication with ABB Drives communication profile.	
	0 ... 30000 rpm	Acceleration/deceleration terminal/initial speed.	1 = 1 rpm
19.02	Speed fb sel	Selects the speed feedback value used in control. <b>Note:</b> The speed feedback value is always estimated.	
	Estimated	A calculated speed estimate is used.	0
19.03	MotorSpeed filt	Defines the time constant of the actual speed filter, i.e. time within the actual speed has reached 63% of the nominal speed (filtered speed = <a href="#">01.01 Motor speed rpm</a> ). If the used speed reference remains constant, the possible interferences in the speed measurement can be filtered with the actual speed filter. Reducing the ripple with filter may cause speed controller tuning problems. A long filter time constant and fast acceleration time contradict one another. A very long filter time results in unstable control. If there are substantial interferences in the speed measurement, the filter time constant should be proportional to the total inertia of the load and motor, in this case 10...30% of the mechanical time constant $t_{mech} = (n_{nom} / T_{nom}) \times J_{tot} \times 2\pi / 60$ , where $J_{tot}$ = total inertia of the load and motor (the gear ratio between the load and motor must be taken into account) $n_{nom}$ = motor nominal speed $T_{nom}$ = motor nominal torque See also parameter <a href="#">23.07 Speed err Ftime</a> .	
	0.000 ... 10000.000 ms	Time constant of the actual speed filter.	1000 = 1 ms
19.06	Zero speed limit	Defines the zero speed limit. The motor is stopped along a speed ramp until the defined zero speed limit is reached. After the limit, the motor coasts to stop.	
	0.00 ... 30000.00 rpm	Zero speed limit.	100 = 1 rpm

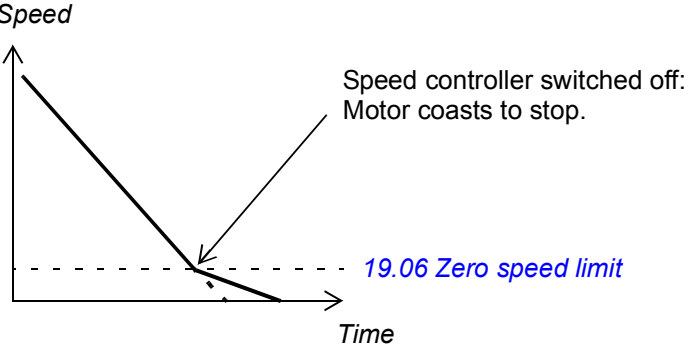
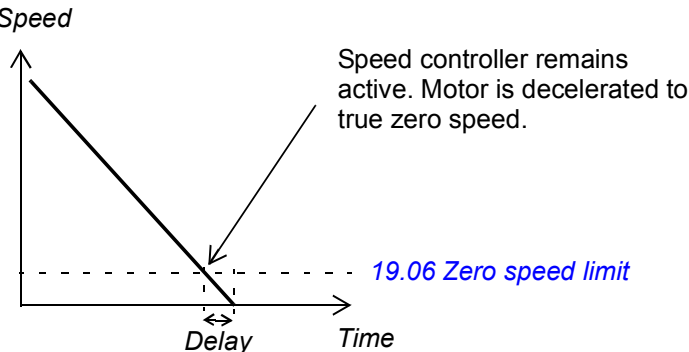
No.	Name/Value	Description	FbEq
19.07	Zero speed delay	<p>Defines the delay for the Zero speed delay function. The function is useful in applications where a smooth and quick restarting is essential. During the delay, the drive knows accurately the rotor position.</p> <p><b>Without Zero speed delay:</b> The drive receives a stop command and decelerates along a ramp. When the motor actual speed falls below the value of <i>19.06 Zero speed limit</i>, the speed controller is switched off. The inverter modulation is stopped and the motor coasts to standstill.</p>  <p><b>With Zero speed delay:</b> The drive receives a stop command and decelerates along a ramp. When the actual motor speed falls below the value of <i>19.06 Zero speed limit</i>, the Zero speed delay function activates. During the delay the function keeps the speed controller live: the inverter modulates, motor is magnetized and the drive is ready for a quick restart.</p> 	
	0 ... 30000 ms	Zero speed delay.	1 = 1 ms
19.08	Above speed lim	Defines the supervision limit for the actual speed.	
	0 ... 30000 rpm	Actual speed supervision limit.	1 = 1 rpm

No.	Name/Value	Description	FbEq
19.09	Speed TripMargin	<p>Defines, together with <a href="#">20.01 Maximum speed</a> and <a href="#">20.02 Minimum speed</a>, the maximum allowed speed of the motor (overspeed protection). If actual speed (<a href="#">01.01 Motor speed rpm</a>) exceeds the speed limit defined by parameter <a href="#">20.01</a> or <a href="#">20.02</a> by more than the value of this parameter, the drive trips on the <b>OVERSPEED (0x7310)</b> fault.</p> <p><b>Example:</b> If the maximum speed is 1420 rpm and speed trip margin is 300 rpm, the drive trips at 1720 rpm.</p>	
	0.0 ... 10000.0 rpm	Overspeed trip margin.	10 = 1 rpm
19.10	Speed window	<p>Defines the absolute value for the motor speed window supervision, i.e. the absolute value for the difference between the actual speed and the unramped speed reference (<a href="#">01.01 Motor speed rpm</a> - <a href="#">03.03 SpeedRef unramp</a>). When the motor speed is within the limits defined by this parameter, signal <a href="#">02.24 FBA main sw</a> bit 8 (AT_SETPOINT) is 1. If the motor speed is not within the defined limits, bit 8 is 0.</p>	
	0 ... 30000 rpm	Absolute value for motor speed window supervision.	1 = 1 rpm
<b>20 Limits</b>		<p>Drive operation limits. See also section <a href="#">Speed controller tuning</a> on page 73.</p>	
20.01	Maximum speed	Defines the allowed maximum speed.	
	0 ... 30000 rpm	Maximum speed.	1 = 1 rpm
20.02	Minimum speed	<p>Defines the allowed minimum speed.</p> <p><b>Note:</b> If the motor may only be run in the forward direction within a certain range above 0 rpm, leave this parameter at 0 rpm, and use parameter <a href="#">21.09 SpeedRef min abs</a> to define the lower boundary of the range.</p>	
	-30000 ... 0 rpm	Minimum speed.	1 = 1 rpm

No.	Name/Value	Description	FbEq
20.03	Pos speed ena	<p>Selects the source of the positive speed reference enable command.</p> <p>1 = Positive speed reference is enabled.  0 = Positive speed reference is interpreted as zero speed reference (In the figure below <a href="#">03.03 SpeedRef unramp</a> is set to zero after the positive speed enable signal has cleared).  The speed reference is set to zero and the motor is stopped along the currently active deceleration ramp.</p>	
		<p>The diagram shows three digital signals over time. The top signal, '20.03 Pos speed ena', starts high and transitions to low. The middle signal, '20.04 Neg speed ena', starts low and transitions to high. The bottom signal, '03.03 SpeedRef unramp', starts high, transitions to low, then back to high, and finally to low again. Vertical dashed lines indicate the timing of these transitions.</p>	
		<p><b>Example:</b> The motor is rotating in the forward direction. To stop the motor, the positive speed enable signal is deactivated by a hardware limit switch (e.g. via a digital input). If the positive speed enable signal remains deactivated and the negative speed enable signal is active, only reverse rotation of the motor is allowed.</p>	
	Const	Bit pointer setting (see <a href="#">Terms and abbreviations</a> on page <a href="#">115</a> ).	-
	Pointer		
20.04	Neg speed ena	Selects the source of the negative speed reference enable command. See parameter <a href="#">20.03 Pos speed ena</a> .	
	Const	Bit pointer setting (see <a href="#">Terms and abbreviations</a> on page <a href="#">115</a> ).	-
	Pointer		
20.05	Maximum current	Defines the maximum allowed motor current.	
	0.00 ... 30000.00 A	Maximum motor current.	100 = 1 A
20.06	Torq lim sel	<p>Defines a source that selects between the two sets of torque limits defined by parameters <a href="#">20.07...20.10</a>.</p> <p>0 = The torque limits defined by parameters <a href="#">20.07 Maximum torque1</a> and <a href="#">20.08 Minimum torque1</a> are in force.  1 = The torque limits defined by parameters <a href="#">20.09 Maximum torque2</a> and <a href="#">20.10 Minimum torque2</a> are in force.</p>	
	Const	Bit pointer setting (see <a href="#">Terms and abbreviations</a> on page <a href="#">115</a> ).	-
	Pointer		
20.07	Maximum torque1	Defines maximum torque limit 1 for the drive (in percent of the motor nominal torque). See parameter <a href="#">20.06 Torq lim sel</a> .	
	0.0 ... 1600.0%	Maximum torque 1.	10 = 1%
20.08	Minimum torque1	<p>Defines minimum torque limit 1 for the drive (in percent of the motor nominal torque). See parameter <a href="#">20.06 Torq lim sel</a>.</p> <p><b>Note:</b> Setting this parameter to 0% is not recommended. Set it lower for better performance.</p>	
	-1600.0 ... 0.0%	Minimum torque 1.	10 = 1%

## 184 Parameters

No.	Name/Value	Description	FbEq
20.09	Maximum torque2	Defines the source of maximum torque limit 2 for the drive (in percent of the motor nominal torque). See parameter <a href="#">20.06 Torq lim sel</a> .	
	AI1 scaled	<a href="#">02.05 AI1 scaled</a> (see page 120).	1073742341
	AI2 scaled	<a href="#">02.07 AI2 scaled</a> (see page 120).	1073742343
	FBA ref1	<a href="#">02.26 FBA main ref1</a> (see page 124).	1073742362
	FBA ref2	<a href="#">02.27 FBA main ref2</a> (see page 124).	1073742363
	Max torque1	<a href="#">20.07 Maximum torque1</a> (see page 183).	1073746951
	Pointer	Value pointer setting (see <a href="#">Terms and abbreviations</a> on page 115).	-
20.10	Minimum torque2	Defines the source of minimum torque limit 2 for the drive (in percent of the motor nominal torque). See parameter <a href="#">20.06 Torq lim sel</a> .	
	AI1 scaled	<a href="#">02.05 AI1 scaled</a> (see page 120).	1073742341
	AI2 scaled	<a href="#">02.07 AI2 scaled</a> (see page 120).	1073742343
	FBA ref1	<a href="#">02.26 FBA main ref1</a> (see page 124).	1073742362
	FBA ref2	<a href="#">02.27 FBA main ref2</a> (see page 124).	1073742363
	Neg max torq	<a href="#">-20.09 Maximum torque2</a> (see page 184).	1073746949
	Min torque1	<a href="#">20.08 Minimum torque1</a> (see page 183).	1073746952
	Pointer	Value pointer setting (see <a href="#">Terms and abbreviations</a> on page 115).	-
20.12	P motoring lim	Defines the maximum allowed power fed by the inverter to the motor in percent of the motor nominal power.	
	0.0 ... 1600.0%	Maximum motoring power.	10 = 1%
20.13	P generating lim	Defines the maximum allowed power fed by the motor to the inverter in percent of the motor nominal power.	
	0.0 ... 1600.0%	Maximum generating power.	10 = 1%
<b>21 Speed ref</b>		Speed reference source selection and processing.	
21.01	Speed ref1 sel	Selects the source for speed reference 1.	
	Zero	Zero speed reference.	0
	AI1 scaled	<a href="#">02.05 AI1 scaled</a> (see page 120).	1073742341
	AI2 scaled	<a href="#">02.07 AI2 scaled</a> (see page 120).	1073742343
	Freq in	<a href="#">02.20 Freq in</a> (see page 120).	1073742356
	FBA ref1	<a href="#">02.26 FBA main ref1</a> (see page 124).	1073742362
	FBA ref2	<a href="#">02.27 FBA main ref2</a> (see page 124).	1073742363
	Panel	<a href="#">02.34 Panel ref</a> (see page 124).	1073742370
	EFB ref1	<a href="#">02.38 EFB main ref1</a> (see page 128).	1073742374
	EFB ref2	<a href="#">02.39 EFB main ref2</a> (see page 128).	1073742375
	Pointer	Value pointer setting (see <a href="#">Terms and abbreviations</a> on page 115).	-
21.02	Speed ref2 sel	Selects the source for speed reference 2. <b>Note:</b> The reference signal must be in the range 0...100.	
	Zero	Zero speed reference.	0
	AI1 scaled	<a href="#">02.05 AI1 scaled</a> (see page 120).	1073742341



No.	Name/Value	Description	FbEq
	AI2 scaled	<a href="#">02.07 AI2 scaled</a> (see page 120).	1073742343
	Freq in	<a href="#">02.20 Freq in</a> (see page 120).	1073742356
	FBA ref1	<a href="#">02.26 FBA main ref1</a> (see page 124).	1073742362
	FBA ref2	<a href="#">02.27 FBA main ref2</a> (see page 124).	1073742363
	Panel	<a href="#">02.34 Panel ref</a> (see page 124).	1073742370
	EFB ref1	<a href="#">02.38 EFB main ref1</a> (see page 128).	1073742374
	EFB ref2	<a href="#">02.39 EFB main ref2</a> (see page 128).	1073742375
	Pointer	Value pointer setting (see <a href="#">Terms and abbreviations</a> on page 115).	-
21.05	Speed share	Defines the scaling factor for the speed reference (the speed reference is multiplied by the defined value).	
	-8.000 ... 8.000	Speed reference scaling factor.	1000 = 1
21.09	SpeedRef min abs	Defines the absolute minimum limit for the speed reference.	
<p><i>Limited speed reference</i></p> <p>The graph illustrates the 'Limited speed reference' function. The horizontal axis is labeled 'Speed reference' and the vertical axis is labeled 'Limited speed reference'. The function is zero for negative speed references. For positive speed references, it rises linearly from a minimum speed (20.02) and stays constant at the maximum speed (20.01). The absolute minimum limit (21.09) is shown as a horizontal line at the bottom of the graph.</p>			
	0 ... 30000 rpm	Absolute minimum limit for speed reference.	1 = 1 rpm

No.	Name/Value	Description	FbEq
<b>22 Speed ref ramp</b>		Speed reference and emergency stop (OFF3) ramp settings.	
22.02	Acc time	<p>Defines acceleration time as the time required for the speed to change from zero to the speed value defined by parameter <a href="#">19.01 Speed scaling</a> (not to parameter <a href="#">20.01 Maximum speed</a>).</p> <p>If the speed reference increases faster than the set acceleration rate, the motor speed will follow the acceleration rate.</p> <p>If the speed reference increases slower than the set acceleration rate, the motor speed will follow the reference signal.</p> <p>If the acceleration time is set too short, the drive will automatically prolong the acceleration in order not to exceed the drive torque limits.</p>	
	0.000 ... 1800.000 s	Acceleration time.	1000 = 1 s
22.03	Dec time	<p>Defines deceleration time as the time required for the speed to change from the speed value defined by parameter <a href="#">19.01 Speed scaling</a> (not from parameter <a href="#">20.01 Maximum speed</a>) to zero.</p> <p>If the speed reference decreases slower than the set deceleration rate, the motor speed will follow the reference signal.</p> <p>If the reference changes faster than the set deceleration rate, the motor speed will follow the deceleration rate.</p> <p>If the deceleration time is set too short, the drive will automatically prolong the deceleration in order not to exceed drive torque limits. If there is any doubt about the deceleration time being too short, ensure that the DC overvoltage control is on (parameter <a href="#">47.01 Overvolt ctrl</a>).</p>	
	0.000 ... 1800.000 s	Deceleration time.	1000 = 1 s

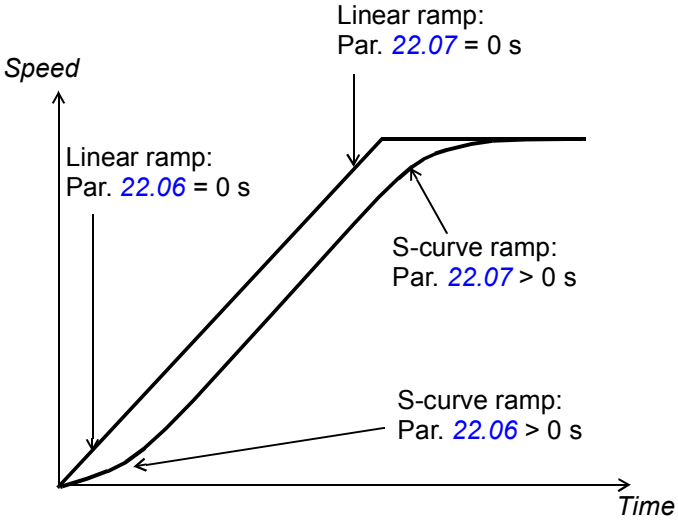
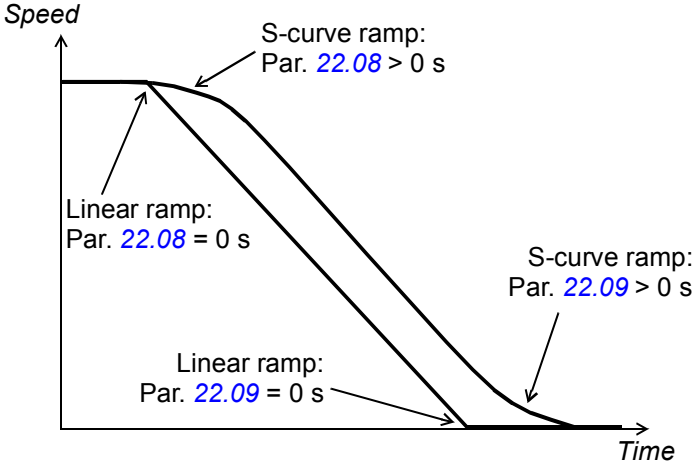
No.	Name/Value	Description	FbEq
22.06	Shape time acc1	<p>Defines the shape of the acceleration ramp at the beginning of the acceleration.</p> <p>0.000 s: Linear ramp. Suitable for steady acceleration or deceleration and for slow ramps.</p> <p>0.001... 1000.000 s: S-curve ramp. The S-curve consists of symmetrical curves at both ends of the ramp and a linear part in between.</p> <p><b>Acceleration:</b></p>  <p><b>Deceleration:</b></p> 	
	0.000 ... 1800.000 s	Ramp shape at start of acceleration.	1000 = 1 s
22.07	Shape time acc2	Defines the shape of the acceleration ramp at the end of the acceleration. See parameter <a href="#">22.06 Shape time acc1</a> .	
	0.000 ... 1800.000 s	Ramp shape at end of acceleration.	1000 = 1 s
22.08	Shape time dec1	Defines the shape of the deceleration ramp at the beginning of the deceleration. See parameter <a href="#">22.06 Shape time acc1</a> .	
	0.000 ... 1800.000 s	Ramp shape at start of deceleration.	1000 = 1 s

No.	Name/Value	Description	FbEq
22.09	Shape time dec2	Defines the shape of the deceleration ramp at the end of the deceleration. See parameter <a href="#">22.06 Shape time acc1</a> .	
	0.000 ... 1800.000 s	Ramp shape at end of deceleration.	1000 = 1 s
22.12	Em stop time	Defines the time inside which the drive is stopped if an emergency stop OFF3 is activated (i.e. the time required for the speed to change from the speed value defined by parameter <a href="#">19.01 Speed scaling</a> to zero). Emergency stop activation source is selected by parameter <a href="#">10.13 Em stop off3</a> . Emergency stop can also be activated through fieldbus ( <a href="#">02.22 FBA main cw</a> or <a href="#">02.36 EFB main cw</a> ). <b>Note:</b> Emergency stop OFF1 uses the active ramp time.	
	0.000 ... 1800.000 s	Emergency stop OFF3 deceleration time.	1000 = 1 s
<b>23 Speed ctrl</b>		Speed controller settings.	
23.01	Proport gain	Defines the proportional gain ( $K_p$ ) of the speed controller. Too large a gain may cause speed oscillation. The figure below shows the speed controller output after an error step when the error remains constant.  <div style="text-align: center;"> <p>Gain = <math>K_p = 1</math>  <math>T_I</math> = Integration time = 0  <math>T_D</math> = Derivation time = 0</p> </div> <p>If gain is set to 1, a 10% change in error value (reference - actual value) causes the speed controller output to change by 10%.</p>	
	0.00 ... 200.00	Proportional gain for speed controller.	100 = 1

No.	Name/Value	Description	FbEq
23.02	Integration time	<p>Defines the integration time of the speed controller. The integration time defines the rate at which the controller output changes when the error value is constant and the proportional gain of the speed controller is 1. The shorter the integration time, the faster the continuous error value is corrected. Too short an integration time makes the control unstable.</p> <p>If parameter value is set to zero, the I-part of the controller is disabled.</p> <p>Anti-windup stops the integrator if the controller output is limited. See <a href="#">06.05 Limit word1</a>.</p> <p>The figure below shows the speed controller output after an error step when the error remains constant.</p>	
0.000 ... 600.000 s	Integration time for speed controller.	1000 = 1 s	

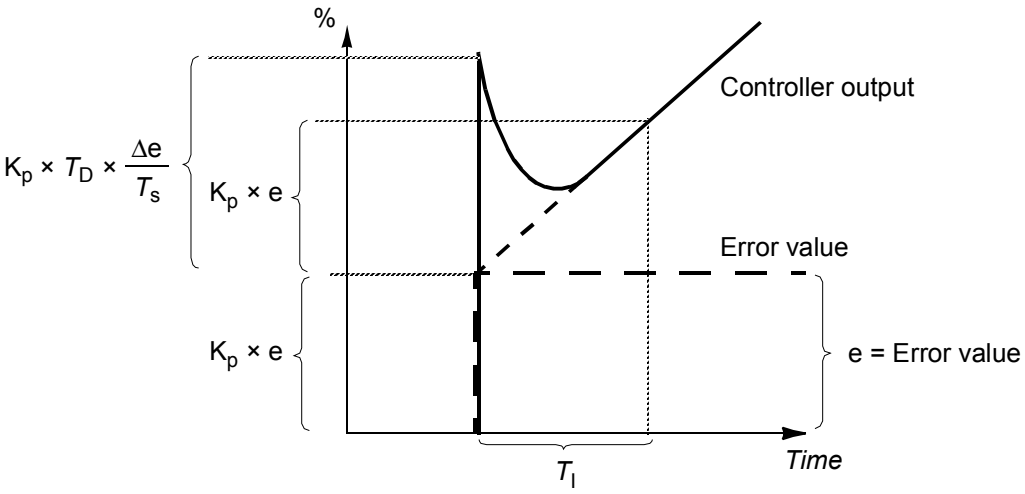
No.	Name/Value	Description	FbEq
23.03	Derivation time	<p>Defines the derivation time of the speed controller. Derivative action boosts the controller output if the error value changes. The longer the derivation time, the more the speed controller output is boosted during the change. If the derivation time is set to zero, the controller works as a PI controller, otherwise as a PID controller. The derivation makes the control more responsive for disturbances. The speed error derivative must be filtered with a low pass filter to eliminate disturbances. The figure below shows the speed controller output after an error step when the error remains constant.</p>  <p>Gain = <math>K_p = 1</math>  <math>T_I</math> = Integration time &gt; 0  <math>T_D</math> = Derivation time &gt; 0  <math>T_s</math> = Sample time period = 250 <math>\mu</math>s  <math>\Delta e</math> = Error value change between two samples</p>	
	0.000 ... 10.000 s	Derivation time for speed controller.	1000 = 1 s
23.04	Deriv filt time	Defines the derivation filter time constant. See parameter <a href="#">23.03 Derivation time</a> .	
	0.0 ... 1000.0 ms	Derivation filter time constant.	10 = 1 ms

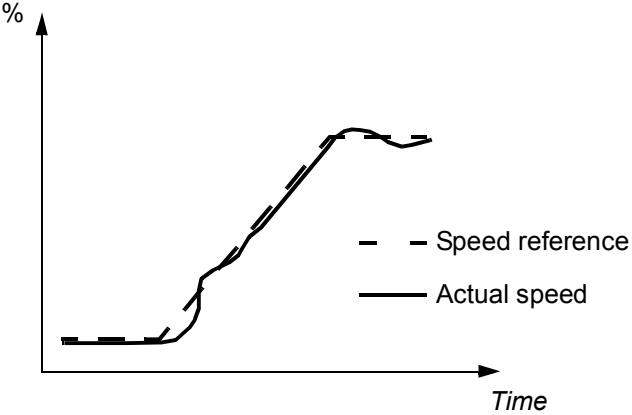
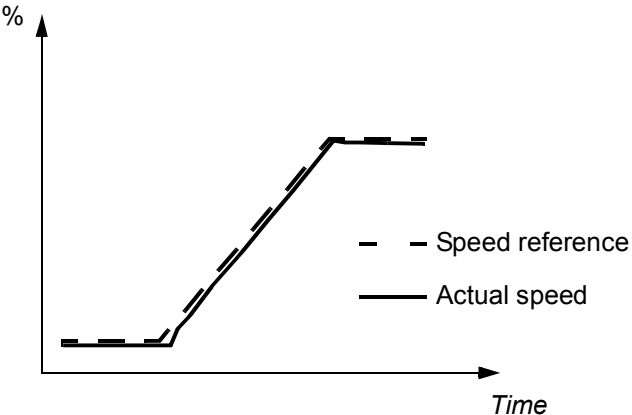
No.	Name/Value	Description	FbEq
23.05	Acc comp DerTime	<p>Defines the derivation time for acceleration/(deceleration) compensation. In order to compensate inertia during acceleration, a derivative of the reference is added to the output of the speed controller. The principle of a derivative action is described for parameter <a href="#">23.03 Derivation time</a>.</p> <p><b>Note:</b> As a general rule, set this parameter to a value between 50 and 100% of the sum of the mechanical time constants of the motor and the driven machine.</p> <p>The figure below shows the speed responses when a high inertia load is accelerated along a ramp.</p> <p><b>No acceleration compensation:</b></p>  <p><b>Acceleration compensation:</b></p> 	
	0.00 ... 600.00 s	Acceleration compensation derivation time.	100 = 1 s
23.06	Acc comp Ftime	Defines the derivation filter time constant for the acceleration/(deceleration) compensation. See parameters <a href="#">23.03 Derivation time</a> and <a href="#">23.05 Acc comp DerTime</a> .	
	0.0 ... 1000.0 ms	Derivation filter time constant for acceleration compensation.	10 = 1 ms
23.07	Speed err Ftime	Defines the time constant of the speed error low pass filter. If the used speed reference changes rapidly, the possible interferences in the speed measurement can be filtered with the speed error filter. Reducing the ripple with filter may cause speed controller tuning problems. A long filter time constant and fast acceleration time contradict one another. A very long filter time results in unstable control.	
	0.0 ... 1000.0 ms	Speed error filtering time constant. 0 = filtering disabled.	10 = 1 ms

## 192 Parameters

No.	Name/Value	Description	FbEq
23.08	Speed additive	Defines a speed reference to be added after ramping. <b>Note:</b> For safety reasons, the additive is not applied when stop functions are active.	
	Zero	Zero speed additive.	0
	AI1 scaled	<a href="#">02.05 AI1 scaled</a> (see page 120).	1073742341
	AI2 scaled	<a href="#">02.07 AI2 scaled</a> (see page 120).	1073742343
	FBA ref1	<a href="#">02.26 FBA main ref1</a> (see page 124).	1073742362
	FBA ref2	<a href="#">02.27 FBA main ref2</a> (see page 124).	1073742363
	Pointer	Value pointer setting (see <a href="#">Terms and abbreviations</a> on page 115).	-
23.09	Max torq sp ctrl	Defines the maximum speed controller output torque.	
	-1600.0 ... 1600.0%	Maximum speed controller output torque.	10 = 1%
23.10	Min torq sp ctrl	Defines the minimum speed controller output torque.	
	-1600.0 ... 1600.0%	Minimum speed controller output torque.	10 = 1%
23.11	SpeedErr winFunc	<p>Enables or disables speed error window control. Speed error window control forms a speed supervision function for a torque-controlled drive. It supervises the speed error value (speed reference – actual speed). In the normal operating range, window control keeps the speed controller input at zero. The speed controller is evoked only if</p> <ul style="list-style-type: none"> <li>the speed error exceeds the upper boundary of the window (parameter <a href="#">23.12 SpeedErr win hi</a>), or</li> <li>the absolute value of the negative speed error exceeds the lower boundary of the window (<a href="#">23.13 SpeedErr win lo</a>).</li> </ul> <p>When the speed error moves outside the window, the exceeding part of the error value is connected to the speed controller. The speed controller produces a reference term relative to the input and gain of the speed controller (parameter <a href="#">23.01 Proport gain</a>) which the torque selector adds to the torque reference. The result is used as the internal torque reference for the drive.</p> <p><b>Example:</b> In a load loss condition, the internal torque reference of the drive is decreased to prevent an excessive rise of the motor speed. If window control were inactive, the motor speed would rise until a speed limit of the drive were reached.</p>	
	Disabled	Speed error window control inactive.	0
	Absolute	Speed error window control active. The boundaries defined by parameters <a href="#">23.12 SpeedErr win hi</a> and <a href="#">23.13 SpeedErr win lo</a> are absolute.	1
	Relative	Speed error window control active. The boundaries defined by parameters <a href="#">23.12 SpeedErr win hi</a> and <a href="#">23.13 SpeedErr win lo</a> are relative to speed reference.	2
23.12	SpeedErr win hi	Defines the upper boundary of the speed error window. Depending on setting of parameter <a href="#">23.11 SpeedErr winFunc</a> , this is either an absolute value or relative to speed reference.	
	0 ... 3000 rpm	Upper boundary of speed error window.	1 = 1 rpm



No.	Name/Value	Description	FbEq
23.13	SpeedErr win lo	Defines the lower boundary of the speed error window. Depending on setting of parameter <a href="#">23.11 SpeedErr winFunc</a> , this is either an absolute value or relative to speed reference.	
	0 ... 3000 rpm	Lower boundary of speed error window.	1 = 1 rpm
23.14	Drooping rate	<p>Defines the drooping rate in percent of the motor nominal speed. Drooping slightly decreases the drive speed as the drive load increases. The actual speed decrease at a certain operating point depends on the drooping rate setting and the drive load (= torque reference / speed controller output). At 100% speed controller output, drooping is at its nominal level, i.e. equal to the value of this parameter. The drooping effect decreases linearly to zero along with the decreasing load.</p> <p>Droop rate can be used e.g. to adjust the load sharing in a Master/Follower application run by several drives. In a Master/Follower application the motor shafts are coupled to each other.</p> <p>The correct droop rate for a process must be found out case by case in practice.</p>	
<p><b>Speed decrease</b> = Speed controller output × Drooping × Max. speed</p> <p><b>Example:</b> Speed controller output is 50%, droop rate is 1%, maximum speed of the drive is 1500 rpm.  Speed decrease = <math>0.50 \times 0.01 \times 1500 \text{ rpm} = 7.5 \text{ rpm}</math>.</p>			
<p>The graph plots 'Motor speed in % of nominal' on the y-axis against 'Speed controller output / Drive load' on the x-axis. Both axes range from 0 to 100%. A solid horizontal line at the 100% mark on the y-axis is labeled 'No drooping'. A dashed line, labeled 'Drooping', starts at the 100% mark on the y-axis when the x-axis value is 0 and slopes downwards linearly to a point below 100% on the y-axis when the x-axis value is 100%. A vertical dashed line at the 100% mark on the x-axis indicates the '23.14 Drooping rate' as the vertical distance between the solid and dashed lines at that point.</p>			
	0.00 ... 100.00%	Droop rate.	100 = 1%

No.	Name/Value	Description	FbEq
23.15	PI adapt max sp	<p>Maximum actual speed for speed controller adaptation. Speed controller gain and integration time can be adapted according to actual speed. This is done by multiplying the gain (23.01 Proport gain) and integration time (23.02 Integration time) by coefficients at certain speeds. The coefficients are defined individually for both gain and integration time.</p> <p>When the actual speed is below or equal to 23.16 PI adapt min sp, 23.01 Proport gain and 23.02 Integration time are multiplied by 23.17 Pcoef at min sp and 23.18 lcoef at min sp respectively.</p> <p>When the actual speed is equal to or exceeds 23.15 PI adapt max sp, no adaptation takes place; in other words, 23.01 Proport gain and 23.02 Integration time are used as such.</p> <p>Between 23.16 PI adapt min sp and 23.15 PI adapt max sp, the coefficients are calculated linearly on the basis of the breakpoints.</p>	
<p style="text-align: center;">Coefficient for <math>K_p</math> or <math>T_i</math></p> <p style="text-align: center;"> <math>K_p</math> = Proportional gain  <math>T_i</math> = Integration time         </p>			
	0 ... 30000 rpm	Maximum actual speed for speed controller adaptation.	1 = 1 rpm
23.16	PI adapt min sp	Minimum actual speed for speed controller adaptation. See parameter 23.15 PI adapt max sp.	
	0 ... 30000 rpm	Minimum actual speed for speed controller adaptation.	1 = 1 rpm
23.17	Pcoef at min sp	Proportional gain coefficient at minimum actual speed. See parameter 23.15 PI adapt max sp.	
	0.000 ... 10.000	Proportional gain coefficient at minimum actual speed.	1000 = 1
23.18	lcoef at min sp	Integration time coefficient at minimum actual speed. See parameter 23.15 PI adapt max sp.	
	0.000 ... 10.000	Integration time coefficient at minimum actual speed.	1000 = 1

No.	Name/Value	Description	FbEq
23.20	PI tune mode	<p>Activates the speed controller autotune function. The autotune will automatically set parameters <a href="#">23.01 Proport gain</a> and <a href="#">23.02 Integration time</a>, as well as <a href="#">01.31 Mech time const</a>. If the <i>User</i> autotune mode is chosen, also <a href="#">23.07 Speed err Ftime</a> is automatically set. The status of the autotune routine is shown by parameter <a href="#">06.03 Speed ctrl stat</a>.</p> <p> <b>WARNING!</b> The motor will reach the torque and current limits during the autotune routine. ENSURE THAT IT IS SAFE TO RUN THE MOTOR BEFORE PERFORMING THE AUTOTUNE ROUTINE!</p> <p><b>Notes:</b></p> <ul style="list-style-type: none"> <li>• Before using the autotune function, the following parameters should be set: <ul style="list-style-type: none"> <li>• All parameters adjusted during the start-up as described in the <i>ACQ810-04 drive modules Start-up Guide</i></li> <li>• <a href="#">19.01 Speed scaling</a></li> <li>• <a href="#">19.03 MotorSpeed filt</a></li> <li>• <a href="#">19.06 Zero speed limit</a></li> <li>• Speed reference ramp settings in group <a href="#">22 Speed ref ramp</a></li> <li>• <a href="#">23.07 Speed err Ftime</a>.</li> </ul> </li> <li>• The drive must be in local control mode and stopped before an autotune is requested.</li> <li>• After requesting an autotune with this parameter, start the drive within 20 seconds.</li> <li>• Wait until the autotune routine is completed (this parameter has reverted to the value <i>Done</i>). The routine can be aborted by stopping the drive.</li> <li>• Check the values of the parameters set by the autotune function.</li> </ul> <p>See also section <a href="#">Speed controller tuning</a> on page <a href="#">73</a>.</p>	
	Done	No tuning has been requested (normal operation)	0
	Smooth	Request speed controller autotune with preset settings for smooth operation.	1
	Middle	Request speed controller autotune with preset settings for medium-tight operation.	2
	Tight	Request speed controller autotune with preset settings for tight operation.	3
	User	Request speed controller autotune with the settings defined by parameters <a href="#">23.21 Tune bandwidth</a> and <a href="#">23.22 Tune damping</a> .	4
23.21	Tune bandwidth	Speed controller bandwidth after autotune procedure in user mode. A larger bandwidth results in more restricted speed controller settings.	
	0.00 ... 2000.00 Hz	Tune bandwidth for user PI tune mode.	100 = 1 Hz
23.22	Tune damping	Speed controller damping after autotune procedure in user mode. Higher damping results in safer and smoother operation.	
	0.0 ... 200.0	Speed controller damping for user PI tune mode.	10 = 1

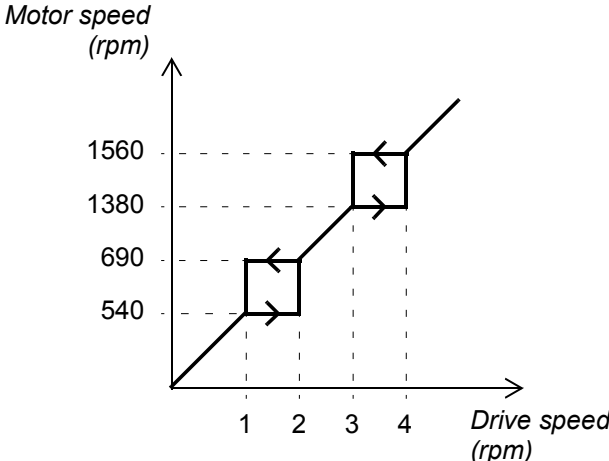
No.	Name/Value	Description	FbEq								
<b>25 Critical speed</b>		Configuration of critical speeds (or ranges of speed) that are avoided due to, for example, mechanical resonance problems.									
25.01	Crit speed sel	<p>Enables/disables the critical speeds function.</p> <p><b>Example:</b> A fan has vibrations in the range of 540 to 690 rpm and 1380 to 1560 rpm. To make the drive to jump over the vibration speed ranges:</p> <ul style="list-style-type: none"> <li>• activate the critical speeds function,</li> <li>• set the critical speed ranges as in the figure below.</li> </ul> <div style="text-align: center;">  <table border="1" data-bbox="729 1131 1121 1321" style="margin-left: auto; margin-right: auto;"> <tr> <td>1</td> <td>Par. 25.02 = 540 rpm</td> </tr> <tr> <td>2</td> <td>Par. 25.03 = 690 rpm</td> </tr> <tr> <td>3</td> <td>Par. 25.04 = 1380 rpm</td> </tr> <tr> <td>4</td> <td>Par. 25.05 = 1590 rpm</td> </tr> </table> </div>	1	Par. 25.02 = 540 rpm	2	Par. 25.03 = 690 rpm	3	Par. 25.04 = 1380 rpm	4	Par. 25.05 = 1590 rpm	
1	Par. 25.02 = 540 rpm										
2	Par. 25.03 = 690 rpm										
3	Par. 25.04 = 1380 rpm										
4	Par. 25.05 = 1590 rpm										
Disable		Critical speeds are disabled.	0								
Enable		Critical speeds are enabled.	1								
25.02	Crit speed1 lo	<p>Defines the low limit for critical speed range 1.</p> <p><b>Note:</b> This value must be less than or equal to the value of <a href="#">25.03 Crit speed1 hi</a>.</p>									
-30000 ... 30000 rpm		Low limit for critical speed 1.	1 = 1 rpm								
25.03	Crit speed1 hi	<p>Defines the high limit for critical speed range 1.</p> <p><b>Note:</b> This value must be greater than or equal to the value of <a href="#">25.02 Crit speed1 lo</a>.</p>									
-30000 ... 30000 rpm		High limit for critical speed 1.	1 = 1 rpm								
25.04	Crit speed2 lo	<p>Defines the low limit for critical speed range 2.</p> <p><b>Note:</b> This value must be less than or equal to the value of <a href="#">25.05 Crit speed2 hi</a>.</p>									
-30000 ... 30000 rpm		Low limit for critical speed 2.	1 = 1 rpm								

No.	Name/Value	Description	FbEq
25.05	Crit speed2 hi	Defines the high limit for critical speed range 2. <b>Note:</b> This value must be greater than or equal to the value of <a href="#">25.04 Crit speed2 lo</a> .	
	-30000 ... 30000 rpm	High limit for critical speed 2.	1 = 1 rpm
25.06	Crit speed3 lo	Defines the low limit for critical speed range 3. <b>Note:</b> This value must be less than or equal to the value of <a href="#">25.07 Crit speed3 hi</a> .	
	-30000 ... 30000 rpm	Low limit for critical speed 3.	1 = 1 rpm
25.07	Crit speed3 hi	Defines the high limit for critical speed range 3. <b>Note:</b> This value must be greater than or equal to the value of <a href="#">25.06 Crit speed3 lo</a> .	
	-30000 ... 30000 rpm	High limit for critical speed 3.	1 = 1 rpm

26 Constant speeds		Constant speed selection and values. An active constant speed overrides the drive speed reference. See also section <a href="#">Constant speeds</a> on page 73.												
26.01	Const speed func	Determines how constant speeds are selected, and whether the rotation direction signal is considered or not when applying a constant speed.												
		<table border="1"> <thead> <tr> <th>Bit</th> <th>Name</th> <th>Information</th> </tr> </thead> <tbody> <tr> <td rowspan="2">0</td> <td rowspan="2">Const speed mode</td> <td>1 = Packed: 7 constant speeds are selectable using the three sources defined by parameters <a href="#">26.02</a>, <a href="#">26.03</a> and <a href="#">26.04</a>.</td> </tr> <tr> <td>0 = Separate: Constant speeds 1, 2 and 3 are separately activated by the sources defined by parameters <a href="#">26.02</a>, <a href="#">26.03</a> and <a href="#">26.04</a> respectively. In case of conflict, the constant speed with the smaller number takes priority.</td> </tr> <tr> <td rowspan="2">1</td> <td rowspan="2">Dir ena</td> <td>1 = Start dir: To determine running direction for a constant speed, the sign of the constant speed setting (parameters <a href="#">26.06...26.12</a>) is multiplied by the direction signal (forward: +1, reverse: -1). For example, if the direction signal is reverse and the active constant speed is negative, the drive will run in the forward direction.</td> </tr> <tr> <td>0 = Accord Par: The running direction for the constant speed is determined by the sign of the constant speed setting (parameters <a href="#">26.06...26.12</a>).</td> </tr> </tbody> </table>	Bit	Name	Information	0	Const speed mode	1 = Packed: 7 constant speeds are selectable using the three sources defined by parameters <a href="#">26.02</a> , <a href="#">26.03</a> and <a href="#">26.04</a> .	0 = Separate: Constant speeds 1, 2 and 3 are separately activated by the sources defined by parameters <a href="#">26.02</a> , <a href="#">26.03</a> and <a href="#">26.04</a> respectively. In case of conflict, the constant speed with the smaller number takes priority.	1	Dir ena	1 = Start dir: To determine running direction for a constant speed, the sign of the constant speed setting (parameters <a href="#">26.06...26.12</a> ) is multiplied by the direction signal (forward: +1, reverse: -1). For example, if the direction signal is reverse and the active constant speed is negative, the drive will run in the forward direction.	0 = Accord Par: The running direction for the constant speed is determined by the sign of the constant speed setting (parameters <a href="#">26.06...26.12</a> ).	
Bit	Name	Information												
0	Const speed mode	1 = Packed: 7 constant speeds are selectable using the three sources defined by parameters <a href="#">26.02</a> , <a href="#">26.03</a> and <a href="#">26.04</a> .												
		0 = Separate: Constant speeds 1, 2 and 3 are separately activated by the sources defined by parameters <a href="#">26.02</a> , <a href="#">26.03</a> and <a href="#">26.04</a> respectively. In case of conflict, the constant speed with the smaller number takes priority.												
1	Dir ena	1 = Start dir: To determine running direction for a constant speed, the sign of the constant speed setting (parameters <a href="#">26.06...26.12</a> ) is multiplied by the direction signal (forward: +1, reverse: -1). For example, if the direction signal is reverse and the active constant speed is negative, the drive will run in the forward direction.												
		0 = Accord Par: The running direction for the constant speed is determined by the sign of the constant speed setting (parameters <a href="#">26.06...26.12</a> ).												

No.	Name/Value	Description	FbEq																																				
26.02	Const speed sel1	When bit 0 of parameter <a href="#">26.01 Const speed func</a> is 0 (Separate), selects a source that activates constant speed 1. When bit 0 of parameter <a href="#">26.01 Const speed func</a> is 1 (Packed), this parameter and parameters <a href="#">26.03 Const speed sel2</a> and <a href="#">26.04 Const speed sel3</a> select three sources whose states activate constant speeds as follows:																																					
		<table border="1"> <thead> <tr> <th>Source defined by par. <a href="#">26.02</a></th> <th>Source defined by par. <a href="#">26.03</a></th> <th>Source defined by par. <a href="#">26.04</a></th> <th>Constant speed active</th> </tr> </thead> <tbody> <tr> <td>0</td> <td>0</td> <td>0</td> <td>None</td> </tr> <tr> <td>1</td> <td>0</td> <td>0</td> <td>Constant speed 1</td> </tr> <tr> <td>0</td> <td>1</td> <td>0</td> <td>Constant speed 2</td> </tr> <tr> <td>1</td> <td>1</td> <td>0</td> <td>Constant speed 3</td> </tr> <tr> <td>0</td> <td>0</td> <td>1</td> <td>Constant speed 4</td> </tr> <tr> <td>1</td> <td>0</td> <td>1</td> <td>Constant speed 5</td> </tr> <tr> <td>0</td> <td>1</td> <td>1</td> <td>Constant speed 6</td> </tr> <tr> <td>1</td> <td>1</td> <td>1</td> <td>Constant speed 7</td> </tr> </tbody> </table>	Source defined by par. <a href="#">26.02</a>	Source defined by par. <a href="#">26.03</a>	Source defined by par. <a href="#">26.04</a>	Constant speed active	0	0	0	None	1	0	0	Constant speed 1	0	1	0	Constant speed 2	1	1	0	Constant speed 3	0	0	1	Constant speed 4	1	0	1	Constant speed 5	0	1	1	Constant speed 6	1	1	1	Constant speed 7	
Source defined by par. <a href="#">26.02</a>	Source defined by par. <a href="#">26.03</a>	Source defined by par. <a href="#">26.04</a>	Constant speed active																																				
0	0	0	None																																				
1	0	0	Constant speed 1																																				
0	1	0	Constant speed 2																																				
1	1	0	Constant speed 3																																				
0	0	1	Constant speed 4																																				
1	0	1	Constant speed 5																																				
0	1	1	Constant speed 6																																				
1	1	1	Constant speed 7																																				
	DI1	Digital input DI1 (as indicated by <a href="#">02.01 DI status</a> , bit 0).	1073742337																																				
	DI2	Digital input DI2 (as indicated by <a href="#">02.01 DI status</a> , bit 1).	1073807873																																				
	DI3	Digital input DI3 (as indicated by <a href="#">02.01 DI status</a> , bit 2).	1073873409																																				
	DI4	Digital input DI4 (as indicated by <a href="#">02.01 DI status</a> , bit 3).	1073938945																																				
	DI5	Digital input DI5 (as indicated by <a href="#">02.01 DI status</a> , bit 4).	1074004481																																				
	Const Pointer	Bit pointer setting (see <a href="#">Terms and abbreviations</a> on page <a href="#">115</a> ).	-																																				
26.03	Const speed sel2	When bit 0 of parameter <a href="#">26.01 Const speed func</a> is 0 (Separate), selects a source that activates constant speed 2. When bit 0 of parameter <a href="#">26.01 Const speed func</a> is 1 (Packed), this parameter and parameters <a href="#">26.02 Const speed sel1</a> and <a href="#">26.04 Const speed sel3</a> select three sources that are used to activate constant speeds. See table at parameter <a href="#">26.02 Const speed sel1</a> .																																					
	DI1	Digital input DI1 (as indicated by <a href="#">02.01 DI status</a> , bit 0).	1073742337																																				
	DI2	Digital input DI2 (as indicated by <a href="#">02.01 DI status</a> , bit 1).	1073807873																																				
	DI3	Digital input DI3 (as indicated by <a href="#">02.01 DI status</a> , bit 2).	1073873409																																				
	DI4	Digital input DI4 (as indicated by <a href="#">02.01 DI status</a> , bit 3).	1073938945																																				
	DI5	Digital input DI5 (as indicated by <a href="#">02.01 DI status</a> , bit 4).	1074004481																																				
	Const Pointer	Bit pointer setting (see <a href="#">Terms and abbreviations</a> on page <a href="#">115</a> ).	-																																				
26.04	Const speed sel3	When bit 0 of parameter <a href="#">26.01 Const speed func</a> is 0 (Separate), selects a source that activates constant speed 3. When bit 0 of parameter <a href="#">26.01 Const speed func</a> is 1 (Packed), this parameter and parameters <a href="#">26.02 Const speed sel1</a> and <a href="#">26.03 Const speed sel2</a> select three sources that are used to activate constant speeds. See table at parameter <a href="#">26.02 Const speed sel1</a> .																																					
	DI1	Digital input DI1 (as indicated by <a href="#">02.01 DI status</a> , bit 0).	1073742337																																				
	DI2	Digital input DI2 (as indicated by <a href="#">02.01 DI status</a> , bit 1).	1073807873																																				

No.	Name/Value	Description	FbEq
	DI3	Digital input DI3 (as indicated by <a href="#">02.01 DI status</a> , bit 2).	1073873409
	DI4	Digital input DI4 (as indicated by <a href="#">02.01 DI status</a> , bit 3).	1073938945
	DI5	Digital input DI5 (as indicated by <a href="#">02.01 DI status</a> , bit 4).	1074004481
	Const Pointer	Bit pointer setting (see <a href="#">Terms and abbreviations</a> on page <a href="#">115</a> ).	-
26.06	Const speed1	Defines constant speed 1.	
	-30000 ... 30000 rpm	Constant speed 1.	1 = 1 rpm
26.07	Const speed2	Defines constant speed 2.	
	-30000 ... 30000 rpm	Constant speed 2.	1 = 1 rpm
26.08	Const speed3	Defines constant speed 3.	
	-30000 ... 30000 rpm	Constant speed 3.	1 = 1 rpm
26.09	Const speed4	Defines constant speed 4.	
	-30000 ... 30000 rpm	Constant speed 4.	1 = 1 rpm
26.10	Const speed5	Defines constant speed 5.	
	-30000 ... 30000 rpm	Constant speed 5.	1 = 1 rpm
26.11	Const speed6	Defines constant speed 6.	
	-30000 ... 30000 rpm	Constant speed 6.	1 = 1 rpm
26.12	Const speed7	Defines constant speed 7.	
	-30000 ... 30000 rpm	Constant speed 7.	1 = 1 rpm
<b>27 Process PID</b>		Configuration of process PID control. See also section <a href="#">PID control</a> on page <a href="#">60</a> .	
27.01	PID setpoint sel	Selects the source of setpoint (reference) for the PID controller.	
	Zero	Zero reference.	0
	Setpoint %	<a href="#">04.25 Setpoint val %</a> (see page <a href="#">130</a> ).	1073742873
	Pointer	Value pointer setting (see <a href="#">Terms and abbreviations</a> on page <a href="#">115</a> ).	-
27.12	PID gain	Defines the gain for the process PID controller. See parameter <a href="#">27.13 PID integ time</a> .	
	0.00 ... 100.00	Gain for PID controller.	100 = 1

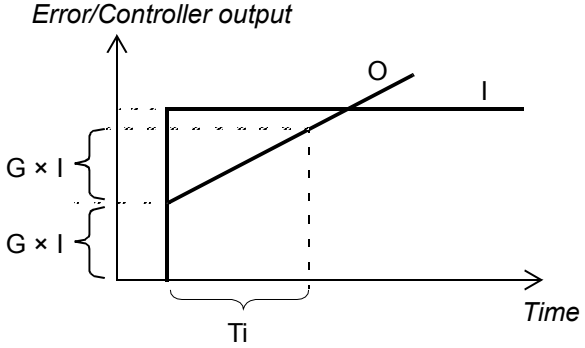
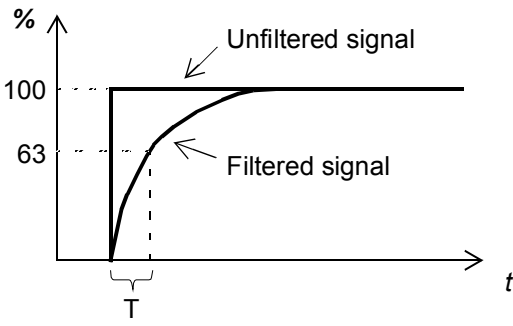
No.	Name/Value	Description	FbEq
27.13	PID integ time	<p>Defines the integration time for the process PID controller.</p>  <p style="text-align: center;"><i>Error/Controller output</i></p> <p style="text-align: right;"><i>Time</i></p> <p style="text-align: center;"><math>T_i</math></p> <p><math>G \times I</math></p> <p><math>G \times I</math></p> <p><math>I =</math> controller input (error)  <math>O =</math> controller output  <math>G =</math> gain  <math>T_i =</math> integration time</p>	
	0.00 ... 320.00 s	Integration time.	100 = 1 s
27.14	PID deriv time	<p>Defines the derivation time of the process PID controller. The derivative component at the controller output is calculated on basis of two consecutive error values (<math>E_{K-1}</math> and <math>E_K</math>) according to the following formula:                      PID DERIV TIME <math>\times (E_K - E_{K-1})/T_S</math>, in which  <math>T_S = 12</math> ms sample time  <math>E =</math> Error = Process setpoint - process actual value.</p>	
	0.00 ... 10.00 s	Derivation time.	100 = 1 s
27.15	PID deriv filter	<p>Defines the time constant of the 1-pole filter used to smooth the derivative component of the process PID controller.</p>  <p style="text-align: center;"><math>\%</math></p> <p style="text-align: right;"><math>t</math></p> <p>Unfiltered signal</p> <p>Filtered signal</p> <p style="text-align: center;"><math>T</math></p> <p><math>100</math></p> <p><math>63</math></p> <p><math>O = I \times (1 - e^{-t/T})</math></p> <p><math>I =</math> filter input (step)  <math>O =</math> filter output  <math>t =</math> time  <math>T =</math> filter time constant</p>	
	0.00 ... 10.00 s	Filter time constant.	100 = 1 s

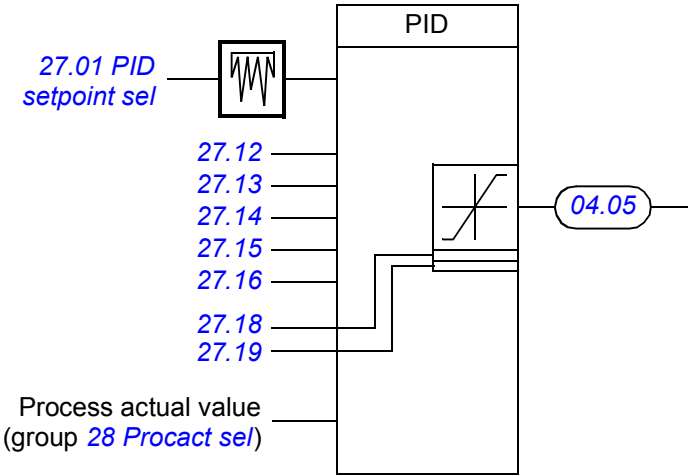

No.	Name/Value	Description	FbEq
27.16	PID error inv	PID error inversion. When the source selected by this parameter is on, the error (process setpoint – process actual value) at the PID controller input is inverted.	
	Const	Bit pointer setting (see <a href="#">Terms and abbreviations</a> on page 115).	-
	Pointer		
27.18	PID maximum	Defines the maximum limit for the PID controller output. Using the minimum and maximum limits, it is possible to restrict the operation range.	
	-32768.0 ... 32768.0	Maximum limit for PID controller output.	10 = 1
27.19	PID minimum	Defines the minimum limit for the PID controller output. See parameter <a href="#">27.18 PID maximum</a> .	
	-32768.0 ... 32768.0	Minimum limit for PID controller output.	10 = 1
27.30	Pid ref freeze	<p>Freezes, or defines a source that can be used to freeze, the setpoint (reference) input of the process PID controller. This feature is useful when the reference is based on a process feedback connected to an analog input, and the sensor must be serviced without stopping the process.</p> <p>The setpoint input of the PID controller is frozen as long as the selected source is 1.</p> <p>See also parameter <a href="#">27.31 Pid out freeze</a>.</p>  <p>Process actual value (group <a href="#">28 Procact sel</a>)</p>	
	No	Process PID controller input not frozen.	0
	Freeze	Process PID controller input frozen.	1
	DI1	Activation of digital input DI1 (as indicated by <a href="#">02.01 DI status</a> , bit 0) freezes process PID controller input.	1073742337
	DI2	Activation of digital input DI2 (as indicated by <a href="#">02.01 DI status</a> , bit 1) freezes process PID controller input.	1073807873
	DI3	Activation of digital input DI3 (as indicated by <a href="#">02.01 DI status</a> , bit 2) freezes process PID controller input.	1073873409
	DI4	Activation of digital input DI4 (as indicated by <a href="#">02.01 DI status</a> , bit 3) freezes process PID controller input.	1073938945
	DI5	Activation of digital input DI5 (as indicated by <a href="#">02.01 DI status</a> , bit 4) freezes process PID controller input.	1074004481
	Const	Bit pointer setting (see <a href="#">Terms and abbreviations</a> on page 115).	-
	Pointer		

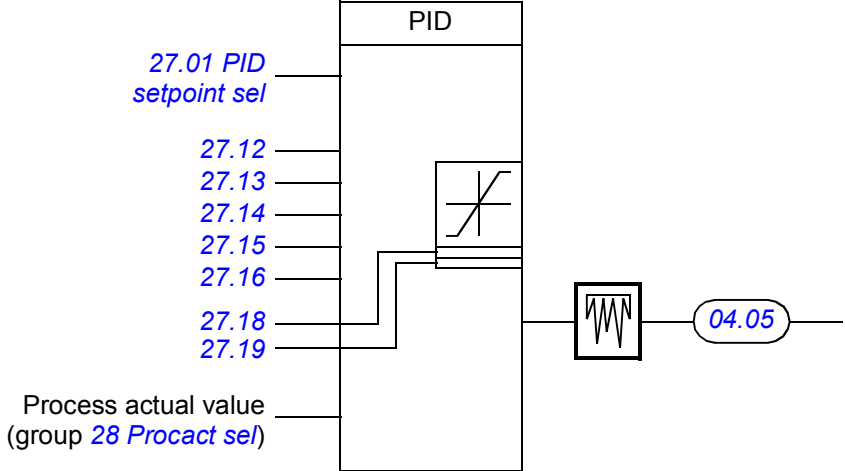
No.	Name/Value	Description	FbEq
27.31	Pid out freeze	<p>Freezes, or defines a source that can be used to freeze, the output of the process PID controller. This feature can be used when, for example, a sensor providing process feedback must be serviced without stopping the process. The output of the PID controller is frozen as long as the selected source is 1.</p> <p>See also parameter <a href="#">27.30 Pid ref freeze</a>.</p> 	
No		Process PID controller output not frozen.	0
Freeze		Process PID controller output frozen.	1
DI1		Activation of digital input DI1 (as indicated by <a href="#">02.01 DI status</a> , bit 0) freezes process PID controller output.	1073742337
DI2		Activation of digital input DI2 (as indicated by <a href="#">02.01 DI status</a> , bit 1) freezes process PID controller output.	1073807873
DI3		Activation of digital input DI3 (as indicated by <a href="#">02.01 DI status</a> , bit 2) freezes process PID controller output.	1073873409
DI4		Activation of digital input DI4 (as indicated by <a href="#">02.01 DI status</a> , bit 3) freezes process PID controller output.	1073938945
DI5		Activation of digital input DI5 (as indicated by <a href="#">02.01 DI status</a> , bit 4) freezes process PID controller output.	1074004481
Const		Bit pointer setting (see <a href="#">Terms and abbreviations</a> on page 115).	-
Pointer			
27.32	Pipefill ref acc	Defines the time for the PID setpoint increase from 0 to 100%.	
	0 ... 100 s	PID setpoint acceleration time.	1 = 1 s
27.33	Pipefill ref dec	Defines the time for the PID setpoint decrease from 100 to 0%.	
	0 ... 100 s	PID setpoint deceleration time.	1 = 1 s
27.34	PID bal ena	<p>Selects a source that enables the PID balancing reference (see parameter <a href="#">27.35 PID bal ref</a>).</p> <p>1 = PID balancing reference enabled.</p>	
	DI1	Digital input DI1 (as indicated by <a href="#">02.01 DI status</a> , bit 0).	1073742337
	DI2	Digital input DI2 (as indicated by <a href="#">02.01 DI status</a> , bit 1).	1073807873
	DI3	Digital input DI3 (as indicated by <a href="#">02.01 DI status</a> , bit 2).	1073873409
	DI4	Digital input DI4 (as indicated by <a href="#">02.01 DI status</a> , bit 3).	1073938945



No.	Name/Value	Description	FbEq
	DI5	Digital input DI5 (as indicated by <a href="#">02.01 DI status</a> , bit 4).	1074004481
	Const	Bit pointer setting (see <a href="#">Terms and abbreviations</a> on page 115).	-
	Pointer		
27.35	PID bal ref	Defines the PID balancing reference. The PID controller output is set to this value when the source selected by parameter <a href="#">27.35 PID bal ref</a> is 1.	
	-32768.0 ... 32768.0%	PID balancing reference.	10 = 1%
27.36	Pump scal speed	Defines pump speed that corresponds to 100% PID controller output.	
	Speed scal	<a href="#">19.01 Speed scaling</a> (see page 180).	1073746689
	Pointer	Value pointer setting (see <a href="#">Terms and abbreviations</a> on page 115).	-
<b>28 Procact sel</b>		Process actual value (feedback) settings.	
28.01	Act val 1/2 sel	Selects the process actual value (1 or 2). Alternatively, selects a source whose status determines which process actual value is used (0 = Actual value 1; 1 = Actual value 2). <b>Note:</b> This parameter is only effective when parameter <a href="#">28.04 Act val func</a> is set to <a href="#">Act1</a> .	
	Act val 1	Process actual value 1 selected.	0
	Act val 2	Process actual value 2 selected.	1
	DI1	Status of digital input DI1 (as indicated by <a href="#">02.01 DI status</a> , bit 0) determines which process actual value is selected.	1073742337
	DI2	Status of digital input DI2 (as indicated by <a href="#">02.01 DI status</a> , bit 1) determines which process actual value is selected.	1073807873
	DI3	Status of digital input DI3 (as indicated by <a href="#">02.01 DI status</a> , bit 2) determines which process actual value is selected.	1073873409
	DI4	Status of digital input DI4 (as indicated by <a href="#">02.01 DI status</a> , bit 3) determines which process actual value is selected.	1073938945
	DI5	Status of digital input DI5 (as indicated by <a href="#">02.01 DI status</a> , bit 4) determines which process actual value is selected.	1074004481
	Const	Bit pointer setting (see <a href="#">Terms and abbreviations</a> on page 115).	-
	Pointer		
28.02	Act val 1 src	Selects the source of process actual value 1.	
	Zero	No source selected.	0
	AI1 scaled	<a href="#">02.05 AI1 scaled</a> (see page 120).	1073742341
	AI2 scaled	<a href="#">02.07 AI2 scaled</a> (see page 120).	1073742343
	AI3 scaled	<a href="#">02.09 AI3 scaled</a> (see page 120).	1073742345
	AI4 scaled	<a href="#">02.11 AI4 scaled</a> (see page 120).	1073742347
	AI5 scaled	<a href="#">02.13 AI5 scaled</a> (see page 120).	1073742349
	FBA procact	<a href="#">02.41 FBA act val</a> (see page 128).	1073742377
	Shared sig1	<a href="#">02.43 Shared signal 1</a> (see page 128).	1073742379
	Flow act	<a href="#">05.05 Flow act</a> (see page 131).	1073743109
	Pointer	Value pointer setting (see <a href="#">Terms and abbreviations</a> on page 115).	-

## 204 Parameters

No.	Name/Value	Description	FbEq
28.03	Act val 2 src	Selects the source of process actual value 2.	
	Zero	No source selected.	0
	AI1 scaled	<a href="#">02.05 AI1 scaled</a> (see page 120).	1073742341
	AI2 scaled	<a href="#">02.07 AI2 scaled</a> (see page 120).	1073742343
	AI3 scaled	<a href="#">02.09 AI3 scaled</a> (see page 120).	1073742345
	AI4 scaled	<a href="#">02.11 AI4 scaled</a> (see page 120).	1073742347
	AI5 scaled	<a href="#">02.13 AI5 scaled</a> (see page 120).	1073742349
	FBA procact	<a href="#">02.41 FBA act val</a> (see page 128).	1073742377
	Shared sig1	<a href="#">02.43 Shared signal 1</a> (see page 128).	1073742379
	Flow act	<a href="#">05.05 Flow act</a> (see page 131).	1073743109
	Pointer	Value pointer setting (see <a href="#">Terms and abbreviations</a> on page 115).	-
28.04	Act val func	Defines how the final process actual value is calculated from the two sources selected by parameters <a href="#">28.02 Act val 1 src</a> and <a href="#">28.03 Act val 2 src</a> .	
	Act1	The actual value is determined by parameter <a href="#">28.01 Act val 1/2 sel</a> .	0
	Add	Sum of actual value 1 and actual value 2.	1
	Sub	Actual value 2 subtracted from actual value 1.	2
	Mul	Actual value 1 multiplied by actual value 2.	3
	Div	Actual value 1 divided by actual value 2.	4
	Max	Greater of the two actual values used.	5
	Min	Smaller of the two actual values used.	6
	Sqrt sub	Square root of (actual value 1 – actual value 2).	7
	Sqrt add	Square root of actual value 1 + square root of actual value 2.	8
28.05	Act max val	Actual value scaling. The setting equals 100% of process setpoint and is typically set to the value that corresponds to the top end of the sensor range.	
	0.00 ... 32768.00%	Actual value scaling.	100 = 1%
28.06	Act unit sel	Defines the unit for both process actual value and process setpoint. Typically the measured quantity is selected.	
	%	%	4
	m3/h	m <sup>3</sup> /h	20
	bar	bar	22
	kPa	kPa	23
	GPM	GPM	24
	psi	psi	25
	inHg	inHg	29
	mbar	mbar	44
	Pa	Pa	45
	inH2O	inH <sub>2</sub> O	58
	in wg	in wg	59
	ft wg	ft wg	60

No.	Name/Value	Description	FbEq
	lbsi	lbsi	61
	m	m	72
	inch	inch	73
28.07	Act FBA scaling	Defines a divisor for process actual value for fieldbus. This parameter can be used to improve calculation accuracy at low and high values.	
	Not used	No scaling applied.	0
	Src/10	The actual value is divided by 10 for fieldbus.	1
	Src/100	The actual value is divided by 100 for fieldbus.	2
	Src/1000	The actual value is divided by 1000 for fieldbus.	3
<b>29 Setpoint sel</b>		Process setpoint (reference) settings.	
29.01	Setpoint 1/2 sel	Selects the process setpoint (1 or 2). Alternatively, selects a source whose status determines which process setpoint is used (0 = Setpoint 1; 1 = Setpoint 2).	
	Setpoint 1	Setpoint 1 selected.	0
	Setpoint 2	Setpoint 2 selected.	1
	DI1	Status of digital input DI1 (as indicated by <a href="#">02.01 DI status</a> , bit 0) determines which process setpoint is selected.	1073742337
	DI2	Status of digital input DI2 (as indicated by <a href="#">02.01 DI status</a> , bit 1) determines which process setpoint is selected.	1073807873
	DI3	Status of digital input DI3 (as indicated by <a href="#">02.01 DI status</a> , bit 2) determines which process setpoint is selected.	1073873409
	DI4	Status of digital input DI4 (as indicated by <a href="#">02.01 DI status</a> , bit 3) determines which process setpoint is selected.	1073938945
	DI5	Status of digital input DI5 (as indicated by <a href="#">02.01 DI status</a> , bit 4) determines which process setpoint is selected.	1074004481
	Const	Bit pointer setting (see <a href="#">Terms and abbreviations</a> on page 115).	-
	Pointer		
29.02	Setpoint 1 src	Selects the source of process setpoint 1.	
	Zero	No source selected.	0
	AI1 scaled	<a href="#">02.05 AI1 scaled</a> (see page 120).	1073742341
	AI2 scaled	<a href="#">02.07 AI2 scaled</a> (see page 120).	1073742343
	AI3 scaled	<a href="#">02.09 AI3 scaled</a> (see page 120).	1073742345
	AI4 scaled	<a href="#">02.11 AI4 scaled</a> (see page 120).	1073742347
	AI5 scaled	<a href="#">02.13 AI5 scaled</a> (see page 120).	1073742349
	FBA setpoint	<a href="#">02.40 FBA setpoint</a> (see page 128).	1073742376
	Shared sig2	<a href="#">02.44 Shared signal 2</a> (see page 128).	1073742380
	Int set 1	<a href="#">29.04 Internal set 1</a> (see below).	1073749252
	Pointer	Value pointer setting (see <a href="#">Terms and abbreviations</a> on page 115).	-
29.03	Setpoint 2 src	Selects the source of process setpoint 2.	
	Zero	No source selected.	0
	AI1 scaled	<a href="#">02.05 AI1 scaled</a> (see page 120).	1073742341
	AI2 scaled	<a href="#">02.07 AI2 scaled</a> (see page 120).	1073742343

No.	Name/Value	Description	FbEq
	AI3 scaled	<a href="#">02.09 AI3 scaled</a> (see page 120).	1073742345
	AI4 scaled	<a href="#">02.11 AI4 scaled</a> (see page 120).	1073742347
	AI5 scaled	<a href="#">02.13 AI5 scaled</a> (see page 120).	1073742349
	FBA setpoint	<a href="#">02.40 FBA setpoint</a> (see page 128).	1073742376
	Shared sig2	<a href="#">02.44 Shared signal 2</a> (see page 128).	1073742380
	Int set 2	<a href="#">29.05 Internal set 2</a> (see below).	1073749253
	Pointer	Value pointer setting (see <a href="#">Terms and abbreviations</a> on page 115).	-
29.04	Internal set 1	Defines process setpoint 1 when parameter <a href="#">29.02 Setpoint 1 src</a> is set to <a href="#">Int set 1</a> .	
	0.00 ... 32768.00%	Internal process setpoint 1.	100 = 1%
29.05	Internal set 2	Defines process setpoint 2 when parameter <a href="#">29.03 Setpoint 2 src</a> is set to <a href="#">Int set 2</a> .	
	0.00 ... 32768.00%	Internal process setpoint 2.	100 = 1%
29.06	Reference step 1	Sets a percentage that is added to the process setpoint when one auxiliary (direct-on-line) motor is running. <i>Example:</i> The drive operates three parallel pumps that pump water into a pipe. The pressure in the pipe is controlled. The constant pressure reference is set by parameter <a href="#">29.04 Internal set 1</a> . During low water consumption, only the speed-regulated pump is run. When water consumption increases, constant-speed (direct-on-line) pumps are started: first one pump, and if the demand grows further, also the other pump. As water flow increases, the pressure loss between the beginning (point of measurement) and the end of the pipe increases. By setting suitable reference steps, the process setpoint is increased along with the increasing pumping capacity. The reference steps compensate the growing pressure loss and prevent the pressure fall at the end of the pipe.	
	0.00 ... 100.00%	Reference step 1.	100 = 1%
29.07	Reference step 2	Sets a percentage that is added to the process setpoint when two auxiliary (direct-on-line) motors are running. See parameter <a href="#">29.06 Reference step 1</a> .	
	0.00 ... 100.00%	Reference step 2.	100 = 1%
29.08	Reference step 3	Sets a percentage that is added to the process setpoint when three auxiliary (direct-on-line) motors are running. See parameter <a href="#">29.06 Reference step 1</a> .	
	0.00 ... 100.00%	Reference step 3.	100 = 1%
29.09	Reference step 4	Sets a percentage that is added to the process setpoint when four auxiliary (direct-on-line) motors are running. See parameter <a href="#">29.06 Reference step 1</a> .	
	0.00 ... 100.00%	Reference step 4.	100 = 1%
29.10	Reference step 5	Sets a percentage that is added to the process setpoint when five auxiliary (direct-on-line) motors are running. See parameter <a href="#">29.06 Reference step 1</a> .	
	0.00 ... 100.00%	Reference step 5.	100 = 1%

No.	Name/Value	Description	FbEq
29.11	Reference step 6	Sets a percentage that is added to the process setpoint when six auxiliary (direct-on-line) motors are running. See parameter <a href="#">29.06 Reference step 1</a> .	
	0.00 ... 100.00%	Reference step 6.	100 = 1%
29.12	Reference step 7	Sets a percentage that is added to the process setpoint when seven auxiliary (direct-on-line) motors are running. See parameter <a href="#">29.06 Reference step 1</a> .	
	0.00 ... 100.00%	Reference step 7.	100 = 1%
<b>30 Fault functions</b>		Configuration of behavior of the drive upon various fault situations.	
30.01	External fault	Selects a source for an external fault signal. 0 = External fault trip 1 = No external fault	
	DI1	Digital input DI1 (as indicated by <a href="#">02.01 DI status</a> , bit 0).	1073742337
	DI2	Digital input DI2 (as indicated by <a href="#">02.01 DI status</a> , bit 1).	1073807873
	DI3	Digital input DI3 (as indicated by <a href="#">02.01 DI status</a> , bit 2).	1073873409
	DI4	Digital input DI4 (as indicated by <a href="#">02.01 DI status</a> , bit 3).	1073938945
	DI5	Digital input DI5 (as indicated by <a href="#">02.01 DI status</a> , bit 4).	1074004481
	Const	Bit pointer setting (see <a href="#">Terms and abbreviations</a> on page <a href="#">115</a> ).	-
	Pointer		
30.02	Speed ref safe	Defines the safe speed reference that is used with the <a href="#">Spd ref Safe</a> setting of supervision parameters <a href="#">13.32 AI superv func</a> , <a href="#">30.03 Panel ctrl loss</a> or <a href="#">50.02 Comm loss func</a> upon an alarm. This speed is used when the parameter is set to <a href="#">Spd ref Safe</a> .	
	-30000 ... 30000 rpm	Safe speed reference.	1 = 1 rpm
30.03	Panel ctrl loss	Selects how the drive reacts to a control panel or PC tool communication break.	
	No	No action taken.	0
	Fault	Drive trips on fault <a href="#">PANEL CTRL LOSS (0x5300)</a> .	1
	Spd ref Safe	The drive generates alarm <a href="#">PANEL CTRL LOSS (0x5300)</a> and sets the speed to the speed defined by parameter <a href="#">30.02 Speed ref safe</a> .  <b>WARNING!</b> Make sure that it is safe to continue operation in case of a communication break.	2
	Last speed	The drive generates alarm <a href="#">PANEL CTRL LOSS (0x5300)</a> and freezes the speed to the level the drive was operating at. The speed is determined by the average speed over the previous 10 seconds.  <b>WARNING!</b> Make sure that it is safe to continue operation in case of a communication break.	3
30.04	Mot phase loss	Selects how the drive reacts when a motor phase loss is detected.	
	No	No action taken.	0
	Fault	The drive trips on fault <a href="#">MOTOR PHASE (0x3182)</a> .	1





No.	Name/Value	Description	FbEq
30.05	Earth fault	Selects how the drive reacts when an earth fault or current unbalance is detected in the motor or the motor cable.	
	No	No action taken.	0
	Warning	The drive generates alarm <i>EARTH FAULT (0x2330)</i> .	1
	Fault	The drive trips on fault <i>EARTH FAULT (0x2330)</i> .	2
30.06	Supply phase loss	Selects how the drive reacts when a supply phase loss is detected.	
	No	No action taken.	0
	Fault	The drive trips on fault <i>SUPPLY PHASE (0x3130)</i> .	1
30.07	Sto diagnostic	Selects how the drive reacts when it detects the absence of one or both Safe torque off (STO) signals. <b>Note:</b> This parameter is for supervision only. The Safe torque off function can activate even when this parameter is set to <i>No</i> . <b>Note:</b> If the drive control unit is externally powered, but no main power is connected to the drive, the <i>STO1 LOST (0x8182)</i> and <i>STO2 LOST (0x8183)</i> faults are disabled. For general information on the Safe torque off function, see the <i>Hardware manual</i> of the drive, and <i>Application guide - Safe torque off function for ACSM1, ACS850 and ACQ810 drives (3AFE68929814 [English])</i> .	
	Fault	The drive trips on <i>SAFE TORQUE OFF (0xFF7A)</i> if one or both of the STO signals are lost.	1
	Alarm	<u>Drive running:</u> The drive trips on <i>SAFE TORQUE OFF (0xFF7A)</i> if one or both of the STO signals are lost. <u>Drive stopped:</u> The drive generates a <i>SAFE TORQUE OFF (0xFF7A)</i> alarm if both STO signals are absent. If only one of the signals is lost, the drive trips on <i>STO1 LOST (0x8182)</i> or <i>STO2 LOST (0x8183)</i> .	2
	No	<u>Drive running:</u> The drive trips on <i>SAFE TORQUE OFF (0xFF7A)</i> if one or both of the STO signals are lost. <u>Drive stopped:</u> No action if both STO signals are absent. If only one of the signals is lost, the drive trips on <i>STO1 LOST (0x8182)</i> or <i>STO2 LOST (0x8183)</i> .	3
	Only Alarm	The drive generates a <i>SAFE TORQUE OFF (0xFF7A)</i> alarm if both STO signals are absent. If only one of the signals is lost, the drive trips on <i>STO1 LOST (0x8182)</i> or <i>STO2 LOST (0x8183)</i> .	4
30.08	Wiring or earth	Selects how the drive reacts to an incorrect input power and motor cable connection, or to a ground (earth) fault in the motor cable or motor. <b>Note:</b> When supplying the drive through the DC connection, set this parameter to <i>No</i> to avoid nuisance fault trips. For more information, refer to <i>Common DC configuration application guide (3AUA0000073108 [English])</i> .	
	No	No action taken.	0
	Fault	The drive trips on fault <i>WIRING OR EARTH FAULT (0x3181)</i> .	1



No.	Name/Value	Description	FbEq
30.09	Stall function	<p>Selects how the drive reacts to a motor stall condition. A stall condition is defined as follows:</p> <ul style="list-style-type: none"> <li>• The drive is at stall current limit (<a href="#">30.10 Stall curr lim</a>), and</li> <li>• the output frequency is below the level set by parameter <a href="#">30.11 Stall freq hi</a>, and</li> <li>• the conditions above have been valid longer than the time set by parameter <a href="#">30.12 Stall time</a>.</li> </ul> <p>See section <a href="#">Stall protection (parameters 30.09...30.12)</a> on page <a href="#">85</a>.</p>	
	<b>Bit</b>	<b>Function</b>	
	0	Ena sup (Enable supervision) 0 = Disabled: Supervision disabled. 1 = Enabled: Supervision enabled.	
	1	Ena warn (Enable warning) 0 = Disabled 1 = Enabled: Drive generates alarm <a href="#">STALL (0x7121)</a> upon a stall condition.	
	2	Ena fault (Enable fault) 0 = Disabled 1 = Enabled: Drive trips on fault <a href="#">STALL (0x7121)</a> upon a stall condition.	
30.10	Stall curr lim	Stall current limit in percent of the nominal current of the motor. See parameter <a href="#">30.09 Stall function</a> .	
	0.0 ... 1600.0%	Stall current limit.	10 = 1%
30.11	Stall freq hi	Stall frequency limit. See parameter <a href="#">30.09 Stall function</a> . <b>Note:</b> Setting the limit below 10 Hz is not recommended.	
	0.5 ... 1000.0 Hz	Stall frequency limit.	10 = 1 Hz
30.12	Stall time	Stall time. See parameter <a href="#">30.09 Stall function</a> .	
	0 ... 3600 s	Stall time.	1 = 1 s
<b>31 Motor therm prot</b>		Motor temperature measurement and thermal protection settings.	
31.01	Mot temp1 prot	Selects how the drive reacts when motor overtemperature is detected by motor thermal protection 1.	
	No	Motor thermal protection 1 inactive.	0
	Alarm	The drive generates alarm <a href="#">MOTOR TEMPERATURE (0x4310)</a> if the temperature exceeds the alarm level defined by parameter <a href="#">31.03 Mot temp1 almLim</a> .	1
	Fault	The drive generates alarm <a href="#">MOTOR TEMPERATURE (0x4310)</a> or trips on fault <a href="#">MOTOR OVERTEMP (0x4310)</a> if the temperature exceeds the alarm/fault level defined by parameter <a href="#">31.02 Mot temp1 almLim</a> / <a href="#">31.03 Mot temp1 almLim</a> (whichever is lower). A faulty temperature sensor or wiring will trip the drive.	2

## 210 Parameters

No.	Name/Value	Description	FbEq
31.02	Mot temp1 src	Selects the means of temperature measurement for motor thermal protection 1. When overtemperature is detected the drive reacts as defined by parameter <a href="#">31.01 Mot temp1 prot</a> .	
	Estimated	The temperature is supervised based on the motor thermal protection model, which uses the motor thermal time constant (parameter <a href="#">31.14 Mot therm time</a> ) and the motor load curve (parameters <a href="#">31.10...31.12</a> ). User tuning is typically needed only if the ambient temperature differs from the normal operating temperature specified for the motor. The motor temperature increases if it operates in the region above the motor load curve. The motor temperature decreases if it operates in the region below the motor load curve (if the motor is overheated).  <b>WARNING!</b> The model does not protect the motor if it does not cool properly due to dust and dirt.	0
	PTC JCU	The temperature is supervised using 1...3 PTC sensors connected to digital input DI5.	4
	Pt100 JCU x1	The temperature is supervised using a Pt100 sensor connected to analog input AI1 and analog output AO1 on the JCU Control Unit of the drive.	7
	Pt100 JCU x2	The temperature is supervised using two Pt100 sensors connected to analog input AI1 and analog output AO1 on the JCU Control Unit of the drive.	8
	Pt100 JCU x3	The temperature is supervised using three Pt100 sensors connected to analog input AI1 and analog output AO1 on the JCU Control Unit of the drive.	9
	Pt100 Ext x1	The temperature is supervised using a Pt100 sensor connected to the first available analog input and analog output on I/O extensions installed on the drive.	10
	Pt100 Ext x2	The temperature is supervised using two Pt100 sensors connected to the first available analog input and analog output on I/O extensions installed on the drive.	11
	Pt100 Ext x3	The temperature is supervised using three Pt100 sensors connected to the first available analog input and analog output on I/O extensions installed on the drive.	12
31.03	Mot temp1 almLim	Defines the alarm limit for motor thermal protection 1 (when parameter <a href="#">31.01 Mot temp1 prot</a> is set to either <i>Alarm</i> or <i>Fault</i> ).	
	0 ... 200 °C	Motor overtemperature alarm limit.	1 = 1 °C
31.04	Mot temp1 fltLim	Defines the fault limit for the motor thermal protection 1 (when parameter <a href="#">31.01 Mot temp1 prot</a> is set to <i>Fault</i> ).	
	0 ... 200 °C	Motor overtemperature fault limit.	1 = 1 °C
31.05	Mot temp2 prot	Selects how the drive reacts when motor overtemperature is detected by motor temperature protection 2.	
	No	Motor temperature protection 2 inactive.	0
	Alarm	The drive generates alarm <a href="#">MOTOR TEMP2 (0x4313)</a> when the temperature exceeds the alarm level defined by parameter <a href="#">31.07 Mot temp2 almLim</a> .	1

No.	Name/Value	Description	FbEq
	Fault	The drive generates alarm <i>MOTOR TEMP2 (0x4313)</i> or trips on fault <i>MOTOR TEMP2 (0x4313)</i> when the temperature exceeds the alarm/fault level defined by parameter <i>31.07 Mot temp2 almLim</i> / <i>31.08 Mot temp2 fltLim</i> (whichever is lower). A faulty temperature sensor or wiring will trip the drive.	2
31.06	Mot temp2 src	Selects the means of temperature measurement for motor thermal protection 2. When overtemperature is detected the drive reacts as defined by parameter <i>31.05 Mot temp2 prot</i> .	
	Estimated	The temperature is supervised based on the motor thermal protection model, which uses the motor thermal time constant (parameter <i>31.14 Mot therm time</i> ) and the motor load curve (parameters <i>31.10...31.12</i> ). User tuning is typically needed only if the ambient temperature differs from the normal operating temperature specified for the motor. The motor temperature increases if it operates in the region above the motor load curve. The motor temperature decreases if it operates in the region below the motor load curve (if the motor is overheated).  <b>WARNING!</b> The model does not protect the motor if it does not cool properly due to dust and dirt.	0
	PTC JCU	The temperature is supervised using 1...3 PTC sensors connected to digital input DI5.	4
	Pt100 JCU x1	The temperature is supervised using a Pt100 sensor connected to analog input AI1 and analog output AO1 on the JCU Control Unit of the drive.	7
	Pt100 JCU x2	The temperature is supervised using two Pt100 sensors connected to analog input AI1 and analog output AO1 on the JCU Control Unit of the drive.	8
	Pt100 JCU x3	The temperature is supervised using three Pt100 sensors connected to analog input AI1 and analog output AO1 on the JCU Control Unit of the drive.	9
	Pt100 Ext x1	The temperature is supervised using a Pt100 sensor connected to the first available analog input and analog output on I/O extensions installed on the drive.	10
	Pt100 Ext x2	The temperature is supervised using two Pt100 sensors connected to the first available analog input and analog output on I/O extensions installed on the drive.	11
	Pt100 Ext x3	The temperature is supervised using three Pt100 sensors connected to the first available analog input and analog output on I/O extensions installed on the drive.	12
31.07	Mot temp2 almLim	Defines the alarm limit for the motor thermal protection 2 (when parameter <i>31.05 Mot temp2 prot</i> is set to either <i>Alarm</i> or <i>Fault</i> ).	
	0 ... 200 °C	Motor overtemperature alarm limit.	1 = 1 °C
31.08	Mot temp2 fltLim	Defines the fault limit for the motor thermal protection 2 (when parameter <i>31.05 Mot temp2 prot</i> is set to <i>Fault</i> ).	
	0 ... 200 °C	Motor overtemperature fault limit.	1 = 1 °C
31.09	Mot ambient temp	Defines the ambient temperature for the thermal protection mode.	
	-60 ... 100 °C	Ambient temperature.	1 = 1 °C

No.	Name/Value	Description	FbEq
31.10	Mot load curve	<p>Defines the load curve together with parameters <a href="#">31.11 Zero speed load</a> and <a href="#">31.12 Break point</a></p> <p>When the parameter is set to 100%, the maximum load is equal to the value of parameter <a href="#">99.06 Mot nom current</a> (higher loads heat up the motor). The load curve level should be adjusted if the ambient temperature differs from the nominal value.</p> <p>The load curve is used by the motor thermal protection model when parameter <a href="#">31.02 Mot temp1 src</a> is set to <a href="#">Estimated</a>.</p>	
<div style="display: flex; align-items: center;"> <div style="margin-right: 20px;"> <p><math>I/I_N</math> (%)</p> <p>150</p> <p>100</p> <p>50</p> <p><a href="#">31.11</a></p> </div> <div style="margin-right: 20px;"> <p><math>I</math> = Motor current <math>I_N</math> = Nominal motor current</p> </div> <div style="text-align: center;"> <p><a href="#">31.10</a></p> <p><a href="#">31.12</a></p> <p>Drive output frequency</p> </div> </div>			
	50 ... 150%	Maximum load for the motor load curve.	1 = 1%
31.11	Zero speed load	<p>Defines the motor load curve together with parameters <a href="#">31.10 Mot load curve</a> and <a href="#">31.12 Break point</a>. Defines the maximum motor load at zero speed of the load curve. A higher value can be used if the motor has an external motor fan to boost the cooling. See the motor manufacturer's recommendations.</p> <p>See parameter <a href="#">31.10 Mot load curve</a>.</p>	
	50 ... 150%	Zero speed load for the motor load curve.	1 = 1%
31.12	Break point	<p>Defines the motor load curve together with parameters <a href="#">31.10 Mot load curve</a> and <a href="#">31.11 Zero speed load</a>. Defines the break point frequency of the load curve i.e. the point at which the motor load curve begins to decrease from the value of parameter <a href="#">31.10 Mot load curve</a> towards the value of parameter <a href="#">31.11 Zero speed load</a>.</p> <p>See parameter <a href="#">31.10 Mot load curve</a>.</p>	
	0.01 ... 500.00 Hz	Break point for the motor load curve.	100 = 1 Hz

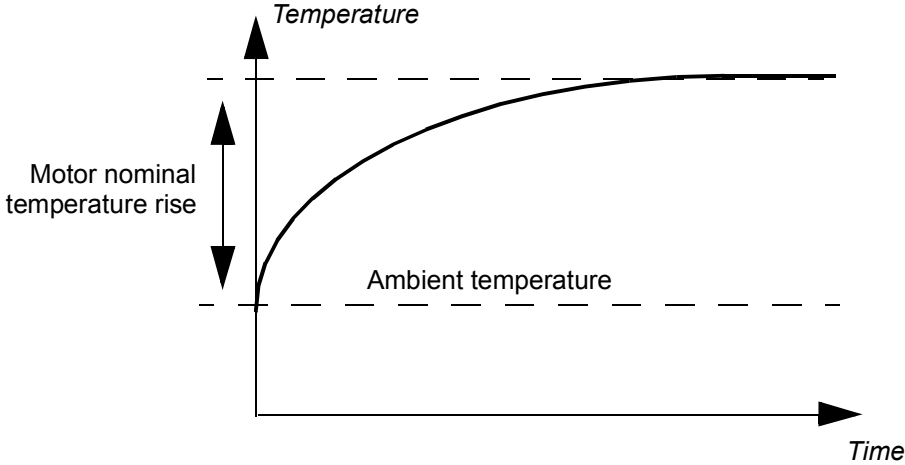
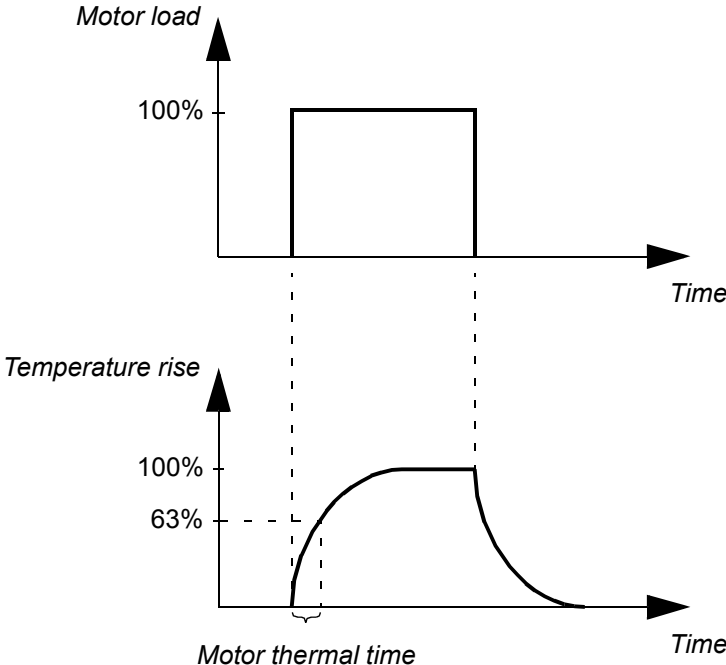
No.	Name/Value	Description	FbEq
31.13	Mot nom tempRise	<p>Defines the temperature rise of the motor when the motor is loaded with nominal current. See the motor manufacturer's recommendations.</p> <p>The temperature rise value is used by the motor thermal protection model when parameter <a href="#">31.02 Mot temp1 src</a> is set to <i>Estimated</i>.</p>	
			
	0 ... 300 °C	Temperature rise.	1 = 1 °C
31.14	Mot therm time	<p>Defines the thermal time constant for the motor thermal protection model (i.e. time inside which the temperature has reached 63% of the nominal temperature). See the motor manufacturer's recommendations.</p> <p>The motor thermal protection model is used when parameter <a href="#">31.02 Mot temp1 src</a> is set to <i>Estimated</i>.</p>	
			
	100 ... 10000 s	Motor thermal time constant.	1 = 1 s

No.	Name/Value	Description	FbEq														
<b>32 Automatic reset</b>		Configuration of conditions for automatic fault resets.															
32.01	Autoreset sel	Selects faults that are automatically reset. The parameter is a 16-bit word with each bit corresponding to a fault type. Whenever a bit is set to 1, the corresponding fault is automatically reset. The bits of the binary number correspond to the following faults:															
		<table border="1"> <thead> <tr> <th>Bit</th> <th>Fault</th> </tr> </thead> <tbody> <tr> <td>0</td> <td>AR overcurrent</td> </tr> <tr> <td>1</td> <td>AR overvoltage</td> </tr> <tr> <td>2</td> <td>AR undervoltage</td> </tr> <tr> <td>3</td> <td>AR AI min</td> </tr> <tr> <td>4</td> <td>Reserved</td> </tr> <tr> <td>5</td> <td>AR external</td> </tr> </tbody> </table>	Bit	Fault	0	AR overcurrent	1	AR overvoltage	2	AR undervoltage	3	AR AI min	4	Reserved	5	AR external	
Bit	Fault																
0	AR overcurrent																
1	AR overvoltage																
2	AR undervoltage																
3	AR AI min																
4	Reserved																
5	AR external																
32.02	Number of trials	Defines the number of automatic fault resets the drive performs within the time defined by parameter <a href="#">32.03 Trial time</a> .															
	0 ... 5	Number of automatic resets.	1 = 1														
32.03	Trial time	Defines the time for the automatic fault reset function. See parameter <a href="#">32.02 Number of trials</a> .															
	1.0 ... 600.0 s	Time for automatic resets.	10 = 1 s														
32.04	Delay time	Defines the time that the drive will wait after a fault before attempting an automatic reset. See parameter <a href="#">32.01 Autoreset sel</a> .															
	0.0 ... 120.0 s	Resetting delay.	10 = 1 s														
<b>33 Supervision</b>		Configuration of signal supervision. See also section <a href="#">Signal supervision</a> on page <a href="#">86</a> .															
33.01	Superv1 func	Selects the mode of supervision 1.															
	Disabled	Supervision 1 not in use.	0														
	Low	When the signal selected by parameter <a href="#">33.02 Superv1 act</a> falls below the value of parameter <a href="#">33.04 Superv1 lo</a> , bit 0 of <a href="#">06.13 Superv status</a> is activated.	1														
	High	When the signal selected by parameter <a href="#">33.02 Superv1 act</a> exceeds the value of parameter <a href="#">33.03 Superv1 hi</a> , bit 0 of <a href="#">06.13 Superv status</a> is activated.	2														
	Abs Low	When the absolute value of the signal selected by parameter <a href="#">33.02 Superv1 act</a> falls below the value of parameter <a href="#">33.04 Superv1 lo</a> , bit 0 of <a href="#">06.13 Superv status</a> is activated.	3														
	Abs High	When the absolute value of the signal selected by parameter <a href="#">33.02 Superv1 act</a> exceeds the value of parameter <a href="#">33.03 Superv1 hi</a> , bit 0 of <a href="#">06.13 Superv status</a> is activated.	4														
33.02	Superv1 act	Selects the signal to be monitored by supervision 1. See parameter <a href="#">33.01 Superv1 func</a> .															
	Speed rpm	<a href="#">01.01 Motor speed rpm</a> (see page <a href="#">118</a> ).	1073742081														
	Speed %	<a href="#">01.02 Motor speed %</a> (see page <a href="#">118</a> ).	1073742082														
	Frequency	<a href="#">01.03 Output frequency</a> (see page <a href="#">118</a> ).	1073742083														

No.	Name/Value	Description	FbEq
	Current	<a href="#">01.04 Motor current</a> (see page 118).	1073742084
	Current %	<a href="#">01.05 Motor current %</a> (see page 118).	1073742085
	Torque	<a href="#">01.06 Motor torque</a> (see page 118).	1073742086
	Dc-voltage	<a href="#">01.07 Dc-voltage</a> (see page 118).	1073742087
	Power inu	<a href="#">01.22 Power inu out</a> (see page 118).	1073742102
	Power motor	<a href="#">01.23 Motor power</a> (see page 118).	1073742103
	SpRef unramp	<a href="#">03.03 SpeedRef unramp</a> (see page 129).	1073742595
	SpRef ramped	<a href="#">03.05 SpeedRef ramped</a> (see page 129).	1073742597
	SpRef used	<a href="#">03.06 SpeedRef used</a> (see page 129).	1073742598
	TorqRef used	<a href="#">03.14 Torq ref used</a> (see page 129).	1073742606
	Process act	<a href="#">04.01 Act val</a> (see page 129).	1073742849
	Proc PID out	<a href="#">04.05 Process PID out</a> (see page 129).	1073742853
	Pointer	Value pointer setting (see <a href="#">Terms and abbreviations</a> on page 115).	-
33.03	Superv1 hi	Selects the upper limit for supervision 1. See parameter <a href="#">33.01 Superv1 func</a> .	
	-32768.00 ... 32768.00	Upper limit for supervision 1.	100 = 1
33.04	Superv1 lo	Selects the lower limit for supervision 1. See parameter <a href="#">33.01 Superv1 func</a> .	
	-32768.00 ... 32768.00	Lower limit for supervision 1.	100 = 1
33.05	Superv2 func	Selects the mode of supervision 2.	
	Disabled	Supervision 2 not in use.	0
	Low	When the signal selected by parameter <a href="#">33.06 Superv2 act</a> falls below the value of parameter <a href="#">33.08 Superv2 lo</a> , bit 1 of <a href="#">06.13 Superv status</a> is activated.	1
	High	When the signal selected by parameter <a href="#">33.06 Superv2 act</a> exceeds the value of parameter <a href="#">33.07 Superv2 hi</a> , bit 1 of <a href="#">06.13 Superv status</a> is activated.	2
	Abs Low	When the absolute value of the signal selected by parameter <a href="#">33.06 Superv2 act</a> falls below the value of parameter <a href="#">33.08 Superv2 lo</a> , bit 1 of <a href="#">06.13 Superv status</a> is activated.	3
	Abs High	When the absolute value of the signal selected by parameter <a href="#">33.06 Superv2 act</a> exceeds the value of parameter <a href="#">33.07 Superv2 hi</a> , bit 1 of <a href="#">06.13 Superv status</a> is activated.	4
33.06	Superv2 act	Selects the signal to be monitored by supervision 2. See parameter <a href="#">33.05 Superv2 func</a> .	
	Speed rpm	<a href="#">01.01 Motor speed rpm</a> (see page 118).	1073742081
	Speed %	<a href="#">01.02 Motor speed %</a> (see page 118).	1073742082
	Frequency	<a href="#">01.03 Output frequency</a> (see page 118).	1073742083
	Current	<a href="#">01.04 Motor current</a> (see page 118).	1073742084
	Current %	<a href="#">01.05 Motor current %</a> (see page 118).	1073742085
	Torque	<a href="#">01.06 Motor torque</a> (see page 118).	1073742086
	Dc-voltage	<a href="#">01.07 Dc-voltage</a> (see page 118).	1073742087
	Power inu	<a href="#">01.22 Power inu out</a> (see page 118).	1073742102

No.	Name/Value	Description	FbEq
	Power motor	<a href="#">01.23 Motor power</a> (see page 118).	1073742103
	SpRef unramp	<a href="#">03.03 SpeedRef unramp</a> (see page 129).	1073742595
	SpRef ramped	<a href="#">03.05 SpeedRef ramped</a> (see page 129).	1073742597
	SpRef used	<a href="#">03.06 SpeedRef used</a> (see page 129).	1073742598
	TorqRef used	<a href="#">03.14 Torq ref used</a> (see page 129).	1073742606
	Process act	<a href="#">04.01 Act val</a> (see page 129).	1073742849
	Proc PID out	<a href="#">04.05 Process PID out</a> (see page 129).	1073742853
	Pointer	Value pointer setting (see <a href="#">Terms and abbreviations</a> on page 115).	-
33.07	Superv2 hi	Selects the upper limit for supervision 2. See parameter <a href="#">33.05 Superv2 func</a> .	
	-32768.00 ... 32768.00	Upper limit for supervision 2.	100 = 1
33.08	Superv2 lo	Selects the lower limit for supervision 2. See parameter <a href="#">33.05 Superv2 func</a> .	
	-32768.00 ... 32768.00	Lower limit for supervision 2.	100 = 1
33.09	Superv3 func	Selects the mode of supervision 3.	
	Disabled	Supervision 3 not in use.	0
	Low	When the signal selected by parameter <a href="#">33.10 Superv3 act</a> falls below the value of parameter <a href="#">33.12 Superv3 lo</a> , bit 2 of <a href="#">06.13 Superv status</a> is activated.	1
	High	When the signal selected by parameter <a href="#">33.10 Superv2 act</a> exceeds the value of parameter <a href="#">33.11 Superv3 hi</a> , bit 2 of <a href="#">06.13 Superv status</a> is activated.	2
	Abs Low	When the absolute value of the signal selected by parameter <a href="#">33.10 Superv3 act</a> falls below the value of parameter <a href="#">33.12 Superv3 lo</a> , bit 2 of <a href="#">06.13 Superv status</a> is activated.	3
	Abs High	When the absolute value of the signal selected by parameter <a href="#">33.10 Superv2 act</a> exceeds the value of parameter <a href="#">33.11 Superv3 hi</a> , bit 2 of <a href="#">06.13 Superv status</a> is activated.	4
33.10	Superv3 act	Selects the signal to be monitored by supervision 3. See parameter <a href="#">33.09 Superv3 func</a> .	
	Speed rpm	<a href="#">01.01 Motor speed rpm</a> (see page 118).	1073742081
	Speed %	<a href="#">01.02 Motor speed %</a> (see page 118).	1073742082
	Frequency	<a href="#">01.03 Output frequency</a> (see page 118).	1073742083
	Current	<a href="#">01.04 Motor current</a> (see page 118).	1073742084
	Current %	<a href="#">01.05 Motor current %</a> (see page 118).	1073742085
	Torque	<a href="#">01.06 Motor torque</a> (see page 118).	1073742086
	Dc-voltage	<a href="#">01.07 Dc-voltage</a> (see page 118).	1073742087
	Power inu	<a href="#">01.22 Power inu out</a> (see page 118).	1073742102
	Power motor	<a href="#">01.23 Motor power</a> (see page 118).	1073742103
	SpRef unramp	<a href="#">03.03 SpeedRef unramp</a> (see page 129).	1073742595
	SpRef ramped	<a href="#">03.05 SpeedRef ramped</a> (see page 129).	1073742597
	SpRef used	<a href="#">03.06 SpeedRef used</a> (see page 129).	1073742598
	TorqRef used	<a href="#">03.14 Torq ref used</a> (see page 129).	1073742606



No.	Name/Value	Description	FbEq
	Process act	<a href="#">04.01 Act val</a> (see page 129).	1073742849
	Proc PID out	<a href="#">04.05 Process PID out</a> (see page 129).	1073742853
	Pointer	Value pointer setting (see <a href="#">Terms and abbreviations</a> on page 115).	-
33.11	Superv3 hi	Selects the upper limit for supervision 3. See parameter <a href="#">33.09 Superv3 func.</a>	
	-32768.00 ... 32768.00	Upper limit for supervision 3.	100 = 1
33.12	Superv3 lo	Selects the lower limit for supervision 3. See parameter <a href="#">33.09 Superv3 func.</a>	
	-32768.00 ... 32768.00	Lower limit for supervision 3.	100 = 1
33.17	Bit0 invert src	Parameters <a href="#">33.17...33.22</a> enable the inversion of freely selectable source bits. The inverted bits are shown by parameter <a href="#">06.17 Bit inverted sw.</a> This parameter selects the source bit, the inverted value of which is shown by <a href="#">06.17 Bit inverted sw</a> , bit 0.	
	DI1	Digital input DI1 (as indicated by <a href="#">02.01DI status</a> , bit 0).	1073742337
	DI2	Digital input DI2 (as indicated by <a href="#">02.01DI status</a> , bit 1).	1073807873
	DI3	Digital input DI3 (as indicated by <a href="#">02.01DI status</a> , bit 2).	1073873409
	DI4	Digital input DI4 (as indicated by <a href="#">02.01DI status</a> , bit 3).	1073938945
	DI5	Digital input DI5 (as indicated by <a href="#">02.01DI status</a> , bit 5).	1074004481
	RO1	Relay output RO1 (as indicated by <a href="#">02.02 RO status</a> , bit 0).	1073742338
	RO2	Relay output RO2 (as indicated by <a href="#">02.02 RO status</a> , bit 1).	1073807874
	RO3	Relay output RO3 (as indicated by <a href="#">02.02 RO status</a> , bit 2).	1073873410
	RO4	Relay output RO4 (as indicated by <a href="#">02.02 RO status</a> , bit 3).	1073938946
	RO5	Relay output RO5 (as indicated by <a href="#">02.02 RO status</a> , bit 4).	1074004482
	Running	Bit 3 of <a href="#">06.01 Status word1</a> (see page 133).	1073939969
	Const	Constant and bit pointer settings (see <a href="#">Terms and abbreviations</a> on page 115).	-
	Pointer		
33.18	Bit1 invert src	Selects the source bit whose inverted value is shown by <a href="#">06.17 Bit inverted sw</a> , bit 1. For the selections, see parameter <a href="#">33.17 Bit0 invert src</a> .	
33.19	Bit2 invert src	Selects the source bit whose inverted value is shown by <a href="#">06.17 Bit inverted sw</a> , bit 2. For the selections, see parameter <a href="#">33.17 Bit0 invert src</a> .	
33.20	Bit3 invert src	Selects the source bit whose inverted value is shown by <a href="#">06.17 Bit inverted sw</a> , bit 3. For the selections, see parameter <a href="#">33.17 Bit0 invert src</a> .	
33.21	Bit4 invert src	Selects the source bit whose inverted value is shown by <a href="#">06.17 Bit inverted sw</a> , bit 4. For the selections, see parameter <a href="#">33.17 Bit0 invert src</a> .	
33.22	Bit5 invert src	Selects the source bit whose inverted value is shown by <a href="#">06.17 Bit inverted sw</a> , bit 5. For the selections, see parameter <a href="#">33.17 Bit0 invert src</a> .	

No.	Name/Value	Description	FbEq														
<b>34</b>	<b>User load curve</b>	Configuration of user load curve. See also section <a href="#">User-definable load curve</a> on page 76.															
34.01	Overload func	Configures the supervision of the upper boundary of the user load curve.															
		<table border="1"> <thead> <tr> <th>Bit</th> <th>Function</th> </tr> </thead> <tbody> <tr> <td>0</td> <td>Ena sup (Enable supervision) 0 = Disabled: Supervision disabled. 1 = Enabled: Supervision enabled.</td> </tr> <tr> <td>1</td> <td>Input value sel (Input value selection) 0 = Current: Current is supervised. 1 = Torque: Torque is supervised.</td> </tr> <tr> <td>2</td> <td>Ena warn (Enable warning) 0 = Disabled 1 = Enabled: Drive generates alarm <a href="#">LOAD CURVE (0x2312)</a> when the curve is exceeded.</td> </tr> <tr> <td>3</td> <td>Ena fault (Enable fault) 0 = Disabled 1 = Enabled: Drive trips on fault <a href="#">LOAD CURVE (0x2312)</a> when the curve is exceeded. <b>Note:</b> This fault must be disabled for the overload curve to work as a triggering condition for the pump cleaning sequence (see parameter <a href="#">82.01 Pump clean trig</a>, bit 9). An active fault would trip the drive, and the cleaning sequence would not be performed.</td> </tr> <tr> <td>4</td> <td>Ena lim integ (Enable limit integration) 0 = Disabled 1 = Enabled: Integration time defined by parameter <a href="#">34.18 Load integ time</a> is used. After the supervision is evoked, the current or torque is limited by the upper boundary of the load curve.</td> </tr> <tr> <td>5</td> <td>Ena lim always (Enable limit always) 0 = Disabled 1 = Enabled: The current or torque is always limited by the upper boundary of the load curve.</td> </tr> </tbody> </table>	Bit	Function	0	Ena sup (Enable supervision) 0 = Disabled: Supervision disabled. 1 = Enabled: Supervision enabled.	1	Input value sel (Input value selection) 0 = Current: Current is supervised. 1 = Torque: Torque is supervised.	2	Ena warn (Enable warning) 0 = Disabled 1 = Enabled: Drive generates alarm <a href="#">LOAD CURVE (0x2312)</a> when the curve is exceeded.	3	Ena fault (Enable fault) 0 = Disabled 1 = Enabled: Drive trips on fault <a href="#">LOAD CURVE (0x2312)</a> when the curve is exceeded. <b>Note:</b> This fault must be disabled for the overload curve to work as a triggering condition for the pump cleaning sequence (see parameter <a href="#">82.01 Pump clean trig</a> , bit 9). An active fault would trip the drive, and the cleaning sequence would not be performed.	4	Ena lim integ (Enable limit integration) 0 = Disabled 1 = Enabled: Integration time defined by parameter <a href="#">34.18 Load integ time</a> is used. After the supervision is evoked, the current or torque is limited by the upper boundary of the load curve.	5	Ena lim always (Enable limit always) 0 = Disabled 1 = Enabled: The current or torque is always limited by the upper boundary of the load curve.	
Bit	Function																
0	Ena sup (Enable supervision) 0 = Disabled: Supervision disabled. 1 = Enabled: Supervision enabled.																
1	Input value sel (Input value selection) 0 = Current: Current is supervised. 1 = Torque: Torque is supervised.																
2	Ena warn (Enable warning) 0 = Disabled 1 = Enabled: Drive generates alarm <a href="#">LOAD CURVE (0x2312)</a> when the curve is exceeded.																
3	Ena fault (Enable fault) 0 = Disabled 1 = Enabled: Drive trips on fault <a href="#">LOAD CURVE (0x2312)</a> when the curve is exceeded. <b>Note:</b> This fault must be disabled for the overload curve to work as a triggering condition for the pump cleaning sequence (see parameter <a href="#">82.01 Pump clean trig</a> , bit 9). An active fault would trip the drive, and the cleaning sequence would not be performed.																
4	Ena lim integ (Enable limit integration) 0 = Disabled 1 = Enabled: Integration time defined by parameter <a href="#">34.18 Load integ time</a> is used. After the supervision is evoked, the current or torque is limited by the upper boundary of the load curve.																
5	Ena lim always (Enable limit always) 0 = Disabled 1 = Enabled: The current or torque is always limited by the upper boundary of the load curve.																
34.02	Underload func	Configures the supervision of the lower boundary of the user load curve.															
		<table border="1"> <thead> <tr> <th>Bit</th> <th>Function</th> </tr> </thead> <tbody> <tr> <td>0</td> <td>Ena sup (Enable supervision) 0 = Disabled: Supervision disabled. 1 = Enabled: Supervision enabled.</td> </tr> <tr> <td>1</td> <td>Input value sel (Input value selection) 0 = Current: Current is supervised. 1 = Torque: Torque is supervised.</td> </tr> <tr> <td>2</td> <td>Ena warn (Enable warning) 0 = Disabled 1 = Enabled: Drive generates alarm <a href="#">LOAD CURVE (0x2312)</a> when the load remains below the curve for longer than the time defined by parameter <a href="#">34.20 Underload time</a>.</td> </tr> <tr> <td>3</td> <td>Ena fault (Enable fault) 0 = Disabled 1 = Enabled: Drive trips on fault <a href="#">LOAD CURVE (0x2312)</a> when the load remains below the curve for longer than the time defined by parameter <a href="#">34.20 Underload time</a>. <b>Note:</b> This fault must be disabled for the underload curve to work as a triggering condition for the pump cleaning sequence (see parameter <a href="#">82.01 Pump clean trig</a>, bit 8). An active fault would trip the drive, and the cleaning sequence would not be performed.</td> </tr> </tbody> </table>	Bit	Function	0	Ena sup (Enable supervision) 0 = Disabled: Supervision disabled. 1 = Enabled: Supervision enabled.	1	Input value sel (Input value selection) 0 = Current: Current is supervised. 1 = Torque: Torque is supervised.	2	Ena warn (Enable warning) 0 = Disabled 1 = Enabled: Drive generates alarm <a href="#">LOAD CURVE (0x2312)</a> when the load remains below the curve for longer than the time defined by parameter <a href="#">34.20 Underload time</a> .	3	Ena fault (Enable fault) 0 = Disabled 1 = Enabled: Drive trips on fault <a href="#">LOAD CURVE (0x2312)</a> when the load remains below the curve for longer than the time defined by parameter <a href="#">34.20 Underload time</a> . <b>Note:</b> This fault must be disabled for the underload curve to work as a triggering condition for the pump cleaning sequence (see parameter <a href="#">82.01 Pump clean trig</a> , bit 8). An active fault would trip the drive, and the cleaning sequence would not be performed.					
Bit	Function																
0	Ena sup (Enable supervision) 0 = Disabled: Supervision disabled. 1 = Enabled: Supervision enabled.																
1	Input value sel (Input value selection) 0 = Current: Current is supervised. 1 = Torque: Torque is supervised.																
2	Ena warn (Enable warning) 0 = Disabled 1 = Enabled: Drive generates alarm <a href="#">LOAD CURVE (0x2312)</a> when the load remains below the curve for longer than the time defined by parameter <a href="#">34.20 Underload time</a> .																
3	Ena fault (Enable fault) 0 = Disabled 1 = Enabled: Drive trips on fault <a href="#">LOAD CURVE (0x2312)</a> when the load remains below the curve for longer than the time defined by parameter <a href="#">34.20 Underload time</a> . <b>Note:</b> This fault must be disabled for the underload curve to work as a triggering condition for the pump cleaning sequence (see parameter <a href="#">82.01 Pump clean trig</a> , bit 8). An active fault would trip the drive, and the cleaning sequence would not be performed.																

No.	Name/Value	Description	FbEq
34.03	Load freq1	Drive output frequency at point 1 of user load curve.	
	1 ... 500 Hz	Frequency at point 1.	1 = 1 Hz
34.04	Load freq2	Drive output frequency at point 2 of user load curve.	
	1 ... 500 Hz	Frequency at point 2.	1 = 1 Hz
34.05	Load freq3	Drive output frequency at point 3 of user load curve.	
	1 ... 500 Hz	Frequency at point 3.	1 = 1 Hz
34.06	Load freq4	Drive output frequency at point 4 of user load curve.	
	1 ... 500 Hz	Frequency at point 4.	1 = 1 Hz
34.07	Load freq5	Drive output frequency at point 5 of user load curve.	
	1 ... 500 Hz	Frequency at point 5.	1 = 1 Hz
34.08	Load low lim1	Minimum load (current or torque) at point 1 of user load curve.	
	0 ... 1600%	Minimum load at point 1.	1 = 1%
34.09	Load low lim2	Minimum load (current or torque) at point 2 of user load curve.	
	0 ... 1600%	Minimum load at point 2.	1 = 1%
34.10	Load low lim3	Minimum load (current or torque) at point 3 of user load curve.	
	0 ... 1600%	Minimum load at point 3.	1 = 1%
34.11	Load low lim4	Minimum load (current or torque) at point 4 of user load curve.	
	0 ... 1600%	Minimum load at point 4.	1 = 1%
34.12	Load low lim5	Minimum load (current or torque) at point 5 of user load curve.	
	0 ... 1600%	Minimum load at point 5.	1 = 1%
34.13	Load high lim1	Maximum load (current or torque) at point 1 of user load curve.	
	0 ... 1600%	Maximum load at point 1.	1 = 1%
34.14	Load high lim2	Maximum load (current or torque) at point 2 of user load curve.	
	0 ... 1600%	Maximum load at point 2.	1 = 1%
34.15	Load high lim3	Maximum load (current or torque) at point 3 of user load curve.	
	0 ... 1600%	Maximum load at point 3.	1 = 1%
34.16	Load high lim4	Maximum load (current or torque) at point 4 of user load curve.	
	0 ... 1600%	Maximum load at point 4.	1 = 1%
34.17	Load high lim5	Maximum load (current or torque) at point 5 of user load curve.	
	0 ... 1600%	Maximum load at point 5.	1 = 1%
34.18	Load integ time	Integration time used in limit supervision whenever enabled by parameter <a href="#">34.01/34.02</a> .	
	0 ... 10000 s	Integration time.	1 = 1 s

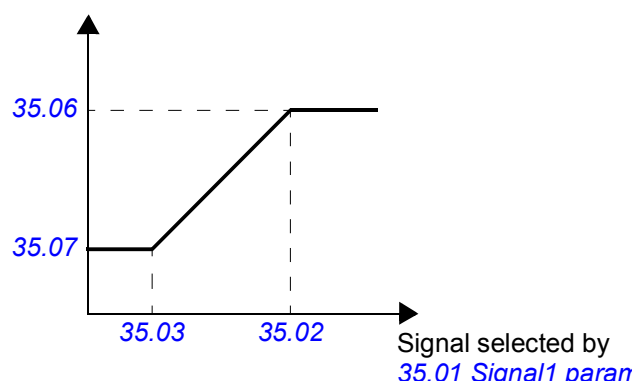
No.	Name/Value	Description	FbEq
34.19	Load cool time	Defines the cooling time. The output of the overload integrator is set to zero if the load stays continuously below the upper boundary of the user load curve.	
	0 ... 10000 s	Load cooling time.	1 = 1 s
34.20	Underload time	Time for the underload function. See parameter <a href="#">34.02 Underload func.</a>	
	0 ... 10000 s	Underload time.	1 = 1 s
<b>35 Process variable</b>		Selection and modification of process variables for display as parameters <a href="#">04.06</a> ... <a href="#">04.08</a> .	
35.01	Signal1 param	Selects a signal to be provided as parameter <a href="#">04.06 Process var1</a> .	
	Speed rpm	<a href="#">01.01 Motor speed rpm</a> (see page <a href="#">118</a> ).	1073742081
	Speed %	<a href="#">01.02 Motor speed %</a> (see page <a href="#">118</a> ).	1073742082
	Frequency	<a href="#">01.03 Output frequency</a> (see page <a href="#">118</a> ).	1073742083
	Current	<a href="#">01.04 Motor current</a> (see page <a href="#">118</a> ).	1073742084
	Current %	<a href="#">01.05 Motor current %</a> (see page <a href="#">118</a> ).	1073742085
	Torque	<a href="#">01.06 Motor torque</a> (see page <a href="#">118</a> ).	1073742086
	Dc-voltage	<a href="#">01.07 Dc-voltage</a> (see page <a href="#">118</a> ).	1073742087
	Power inu	<a href="#">01.22 Power inu out</a> (see page <a href="#">118</a> ).	1073742102
	Power motor	<a href="#">01.23 Motor power</a> (see page <a href="#">118</a> ).	1073742103
	SpRef unramp	<a href="#">03.03 SpeedRef unramp</a> (see page <a href="#">129</a> ).	1073742595
	SpRef ramped	<a href="#">03.05 SpeedRef ramped</a> (see page <a href="#">129</a> ).	1073742597
	SpRef used	<a href="#">03.06 SpeedRef used</a> (see page <a href="#">129</a> ).	1073742598
	TorqRef used	<a href="#">03.14 Torq ref used</a> (see page <a href="#">129</a> ).	1073742606
	Process act	<a href="#">04.01 Act val</a> (see page <a href="#">129</a> ).	1073742849
	Proc PID out	<a href="#">04.05 Process PID out</a> (see page <a href="#">129</a> ).	1073742853
	Pointer	Value pointer setting (see <a href="#">Terms and abbreviations</a> on page <a href="#">115</a> ).	-
35.02	Signal1 max	Defines the real value of the selected signal that corresponds to the maximum display value defined by parameter <a href="#">35.06 Proc var1 max</a> .  <i>04.06 Process var1</i> 	
	-32768...32768	Real signal value corresponding to maximum process variable 1 value.	1 = 1

No.	Name/Value	Description	FbEq
35.03	Signal1 min	Defines the real value of the selected signal that corresponds to the minimum display value defined by parameter <a href="#">35.07 Proc var1 min</a> . See diagram at parameter <a href="#">35.02 Signal1 max</a> .	
	-32768...32768	Real signal value corresponding to minimum process variable 1 value.	1 = 1
35.04	Proc var1 dispf	Scaling for process variable 1. This setting also scales the value for fieldbus.	
	0	1 = 1	0
	1	10 = 1	1
	2	100 = 1	2
	3	1000 = 1	3
	4	10000 = 1	4
	5	100000 = 1	5
35.05	Proc var1 unit	Specifies the unit for parameter <a href="#">04.06 Process var1</a> (process variable 1).	
	0	None	0
	1	A	1
	2	V	2
	3	Hz	3
	4	%	4
	5	s	5
	6	h	6
	7	rpm	7
	8	kh	8
	9	C	9
	10	lbft	10
	11	mA	11
	12	mV	12
	13	kW	13
	14	W	14
	15	kWh	15
	16	F	16
	17	hp	17
	18	MWh	18
	19	m/s	19
	20	m <sup>3</sup> /h	20
	21	dm <sup>3</sup> /h	21
	22	bar	22
	23	kPa	23
	24	GPM	24
	25	PSI	25
	26	CFM	26

## 222 Parameters

No.	Name/Value	Description	FbEq
27		ft	27
28		MGD	28
29		inHg	29
30		FPM	30
31		kbits	31
32		kHz	32
33		Ohm	33
34		ppm	34
35		pps	35
36		l/s	36
37		l/min	37
38		l/h	38
39		m3/s	39
40		m3/m	40
41		kg/s	41
42		kg/m	42
43		kg/h	43
44		mbar	44
45		Pa	45
46		GPS	46
47		gal/s	47
48		gal/m	48
49		gal/h	49
50		ft3/s	50
51		ft3/m	51
52		ft3/h	52
53		lb/s	53
54		lb/m	54
55		lb/h	55
56		FPS	56
57		ft/s	57
58		inH2O	58
59		inwg	59
60		ftwg	60
61		lbsi	61
62		ms	62
63		Mrev	63
64		days	64
65		inWC	65
66		mpmin	66
67		week	67

No.	Name/Value	Description	FbEq
68		tonne	68
69		m/s <sup>2</sup>	69
70		rev	70
71		deg	71
72		m	72
73		inch	73
74		inc	74
75		m/s <sup>3</sup>	75
76		kg/m <sup>2</sup>	76
77		kg/m <sup>3</sup>	77
78		m <sup>3</sup>	78
79		[blank]	79
80		u/s	80
81		u/min	81
82		u/h	82
83...84		[blank]	83...84
85		u/s <sup>2</sup>	85
86		min-2	86
87		u/h <sup>2</sup>	87
88...89		[blank]	88...89
90		Vrms	90
91		bits	91
92		Nm	92
93		p.u.	93
94		1/s	94
95		mH	95
96		mOhm	96
97		us	97
98		C/W	98
35.06	Proc var1 max	Maximum value for process variable 1. See diagram at parameter <a href="#">35.02 Signal1 max</a> .	
	-32768...32768	Maximum value for process variable 1.	1 = 1
35.07	Proc var1 min	Minimum value for process variable 1. See diagram at parameter <a href="#">35.02 Signal1 max</a> .	
	-32768...32768	Minimum value for process variable 1.	1 = 1
35.08	Signal2 param	Selects a signal to be provided as parameter <a href="#">04.07 Process var2</a> .	
	Speed rpm	<a href="#">01.01 Motor speed rpm</a> (see page <a href="#">118</a> ).	1073742081
	Speed %	<a href="#">01.02 Motor speed %</a> (see page <a href="#">118</a> ).	1073742082
	Frequency	<a href="#">01.03 Output frequency</a> (see page <a href="#">118</a> ).	1073742083
	Current	<a href="#">01.04 Motor current</a> (see page <a href="#">118</a> ).	1073742084
	Current %	<a href="#">01.05 Motor current %</a> (see page <a href="#">118</a> ).	1073742085

No.	Name/Value	Description	FbEq
	Torque	<a href="#">01.06 Motor torque</a> (see page 118).	1073742086
	Dc-voltage	<a href="#">01.07 Dc-voltage</a> (see page 118).	1073742087
	Power inu	<a href="#">01.22 Power inu out</a> (see page 118).	1073742102
	Power motor	<a href="#">01.23 Motor power</a> (see page 118).	1073742103
	SpRef unramp	<a href="#">03.03 SpeedRef unramp</a> (see page 129).	1073742595
	SpRef ramped	<a href="#">03.05 SpeedRef ramped</a> (see page 129).	1073742597
	SpRef used	<a href="#">03.06 SpeedRef used</a> (see page 129).	1073742598
	TorqRef used	<a href="#">03.14 Torq ref used</a> (see page 129).	1073742606
	Process act	<a href="#">04.01 Act val</a> (see page 129).	1073742849
	Proc PID out	<a href="#">04.05 Process PID out</a> (see page 129).	1073742853
	Pointer	Value pointer setting (see <a href="#">Terms and abbreviations</a> on page 115).	-
35.09	Signal2 max	<p>Defines the real value of the selected signal that corresponds to the maximum display value defined by parameter <a href="#">35.13 Proc var2 max</a>.</p> <p><a href="#">04.07 Process var2</a></p>	
	-32768...32768	Real signal value corresponding to maximum process variable 2 value.	1 = 1
35.10	Signal2 min	Defines the real value of the selected signal that corresponds to the minimum display value defined by parameter <a href="#">35.14 Proc var2 min</a> . See diagram at parameter <a href="#">35.09 Signal2 max</a> .	
	-32768...32768	Real signal value corresponding to minimum process variable 2 value.	1 = 1
35.11	Proc var2 dispf	Scaling for process variable 2. This setting also scales the value for fieldbus.	
	0	1 = 1	0
	1	10 = 1	1
	2	100 = 1	2
	3	1000 = 1	3
	4	10000 = 1	4
	5	100000 = 1	5

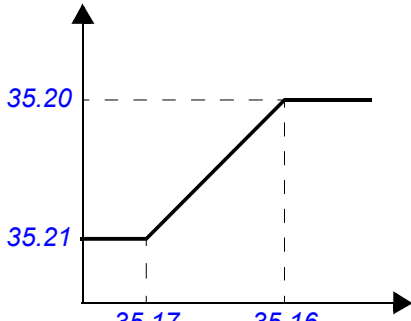

No.	Name/Value	Description	FbEq
35.12	Proc var2 unit	Specifies the unit for parameter <a href="#">04.07 Process var2</a> (process variable 2).	
	0...98	See parameter <a href="#">35.05 Proc var1 unit</a> .	1 = 1
35.13	Proc var2 max	Maximum value for process variable 2. See diagram at parameter <a href="#">35.09 Signal2 max</a> .	
	-32768...32768	Maximum value for process variable 2.	1 = 1
35.14	Proc var2 min	Minimum value for process variable 2. See diagram at parameter <a href="#">35.09 Signal2 max</a> .	
	-32768...32768	Minimum value for process variable 2.	1 = 1
35.15	Signal3 param	Selects a signal to be provided as parameter <a href="#">04.08 Process var3</a> .	
	Speed rpm	<a href="#">01.01 Motor speed rpm</a> (see page <a href="#">118</a> ).	1073742081
	Speed %	<a href="#">01.02 Motor speed %</a> (see page <a href="#">118</a> ).	1073742082
	Frequency	<a href="#">01.03 Output frequency</a> (see page <a href="#">118</a> ).	1073742083
	Current	<a href="#">01.04 Motor current</a> (see page <a href="#">118</a> ).	1073742084
	Current %	<a href="#">01.05 Motor current %</a> (see page <a href="#">118</a> ).	1073742085
	Torque	<a href="#">01.06 Motor torque</a> (see page <a href="#">118</a> ).	1073742086
	Dc-voltage	<a href="#">01.07 Dc-voltage</a> (see page <a href="#">118</a> ).	1073742087
	Power inu	<a href="#">01.22 Power inu out</a> (see page <a href="#">118</a> ).	1073742102
	Power motor	<a href="#">01.23 Motor power</a> (see page <a href="#">118</a> ).	1073742103
	SpRef unram	<a href="#">03.03 SpeedRef unram</a> (see page <a href="#">129</a> ).	1073742595
	SpRef ramped	<a href="#">03.05 SpeedRef ramped</a> (see page <a href="#">129</a> ).	1073742597
	SpRef used	<a href="#">03.06 SpeedRef used</a> (see page <a href="#">129</a> ).	1073742598
	TorqRef used	<a href="#">03.14 Torq ref used</a> (see page <a href="#">129</a> ).	1073742606
	Process act	<a href="#">04.01 Act val</a> (see page <a href="#">129</a> ).	1073742849
	Proc PID out	<a href="#">04.05 Process PID out</a> (see page <a href="#">129</a> ).	1073742853
	Pointer	Value pointer setting (see <a href="#">Terms and abbreviations</a> on page <a href="#">115</a> ).	-
35.16	Signal3 max	Defines the real value of the selected signal that corresponds to the maximum display value defined by parameter <a href="#">35.20 Proc var3 max</a> .  <i>04.08 Process var3</i>  Signal selected by <a href="#">35.15 Signal3 param</a>	
	-32768...32768	Real signal value corresponding to maximum process variable 3 value.	1 = 1

No.	Name/Value	Description	FbEq
35.17	Signal3 min	Defines the real value of the selected signal that corresponds to the minimum display value defined by parameter <a href="#">35.21 Proc var3 min</a> . See diagram at parameter <a href="#">35.16 Signal3 max</a> .	
	-32768...32768	Real signal value corresponding to minimum process variable 3 value.	1 = 1
35.18	Proc var3 dispf	Scaling for process variable 3. This setting also scales the value for fieldbus.	
	0	1 = 1	0
	1	10 = 1	1
	2	100 = 1	2
	3	1000 = 1	3
	4	10000 = 1	4
	5	100000 = 1	5
35.19	Proc var3 unit	Specifies the unit for parameter <a href="#">04.08 Process var3</a> (process variable 3).	
	0...98	See parameter <a href="#">35.05 Proc var1 unit</a> .	1 = 1
35.20	Proc var3 max	Maximum value for process variable 3. See diagram at parameter <a href="#">35.16 Signal3 max</a> .	
	-32768...32768	Maximum value for process variable 3.	1 = 1
35.21	Proc var3 min	Minimum value for process variable 3. See diagram at parameter <a href="#">35.16 Signal3 max</a> .	
	-32768...32768	Minimum value for process variable 3.	1 = 1
<b>36 Timed functions</b>		Configuration of timers. See also section <a href="#">Timers</a> on page <a href="#">79</a> .	
36.01	Timers enable	Enable/disable control for timers. Whenever the source selected by this parameter is off, timers are disabled; when the source is on, timers are enabled.	
	DI1	Digital input DI1 (as indicated by <a href="#">02.01 DI status</a> , bit 0).	1073742337
	DI2	Digital input DI2 (as indicated by <a href="#">02.01 DI status</a> , bit 1).	1073807873
	DI3	Digital input DI3 (as indicated by <a href="#">02.01 DI status</a> , bit 2).	1073873409
	DI4	Digital input DI4 (as indicated by <a href="#">02.01 DI status</a> , bit 3).	1073938945
	DI5	Digital input DI5 (as indicated by <a href="#">02.01 DI status</a> , bit 4).	1074004481
	Const	Bit pointer setting (see <a href="#">Terms and abbreviations</a> on page <a href="#">115</a> ).	-
	Pointer		

No.	Name/Value	Description	FbEq										
36.02	Timers mode	Specifies whether the time periods defined by parameters <a href="#">36.03 Start time1</a> ... <a href="#">36.18 Stop day4</a> are valid daily or weekly.											
	<table border="1"> <thead> <tr> <th>Bit</th> <th>Function</th> </tr> </thead> <tbody> <tr> <td>0</td> <td>Timer1 mode 0 = Daily 1 = Weekly</td> </tr> <tr> <td>1</td> <td>Timer2 mode 0 = Daily 1 = Weekly</td> </tr> <tr> <td>2</td> <td>Timer3 mode 0 = Daily 1 = Weekly</td> </tr> <tr> <td>3</td> <td>Timer4 mode 0 = Daily 1 = Weekly</td> </tr> </tbody> </table>	Bit	Function	0	Timer1 mode 0 = Daily 1 = Weekly	1	Timer2 mode 0 = Daily 1 = Weekly	2	Timer3 mode 0 = Daily 1 = Weekly	3	Timer4 mode 0 = Daily 1 = Weekly		
Bit	Function												
0	Timer1 mode 0 = Daily 1 = Weekly												
1	Timer2 mode 0 = Daily 1 = Weekly												
2	Timer3 mode 0 = Daily 1 = Weekly												
3	Timer4 mode 0 = Daily 1 = Weekly												
36.03	Start time1	Defines the start time for time period 1.											
	00:00:00 ... 24:00:00	Start time for time period 1.	1 = 1 s (24:00:00 = 86400)										
36.04	Stop time1	Defines the stop time for time period 1.											
	00:00:00 ... 24:00:00	Stop time for time period 1.	1 = 1 s (24:00:00 = 86400)										
36.05	Start day1	Defines the week day on which time period 1 begins.											
	Monday	Time period 1 starts on Monday.	1										
	Tuesday	Time period 1 starts on Tuesday.	2										
	Wednesday	Time period 1 starts on Wednesday.	3										
	Thursday	Time period 1 starts on Thursday.	4										
	Friday	Time period 1 starts on Friday.	5										
	Saturday	Time period 1 starts on Saturday.	6										
	Sunday	Time period 1 starts on Sunday.	7										
36.06	Stop day1	Defines the week day on which time period 1 ends.											
	Monday	Time period 1 ends on Monday.	1										
	Tuesday	Time period 1 ends on Tuesday.	2										
	Wednesday	Time period 1 ends on Wednesday.	3										
	Thursday	Time period 1 ends on Thursday.	4										
	Friday	Time period 1 ends on Friday.	5										
	Saturday	Time period 1 ends on Saturday.	6										
	Sunday	Time period 1 ends on Sunday.	7										
36.07	Start time2	Defines the start time for time period 2.											
	00:00:00 ... 24:00:00	Start time for time period 2.	1 = 1 s (24:00:00 = 86400)										

No.	Name/Value	Description	FbEq
36.08	Stop time2	Defines the stop time for time period 2.	
	00:00:00 ... 24:00:00	Stop time for time period 2.	1 = 1 s (24:00:00 = 86400)
36.09	Start day2	Defines the week day on which time period 2 begins.	
	Monday	Time period 2 starts on Monday.	1
	Tuesday	Time period 2 starts on Tuesday.	2
	Wednesday	Time period 2 starts on Wednesday.	3
	Thursday	Time period 2 starts on Thursday.	4
	Friday	Time period 2 starts on Friday.	5
	Saturday	Time period 2 starts on Saturday.	6
	Sunday	Time period 2 starts on Sunday.	7
36.10	Stop day2	Defines the week day on which time period 2 ends.	
	Monday	Time period 2 ends on Monday.	1
	Tuesday	Time period 2 ends on Tuesday.	2
	Wednesday	Time period 2 ends on Wednesday.	3
	Thursday	Time period 2 ends on Thursday.	4
	Friday	Time period 2 ends on Friday.	5
	Saturday	Time period 2 ends on Saturday.	6
	Sunday	Time period 2 ends on Sunday.	7
36.11	Start time3	Defines the start time for time period 3.	
	00:00:00 ... 24:00:00	Start time for time period 3.	1 = 1 s (24:00:00 = 86400)
36.12	Stop time3	Defines the stop time for time period 3.	
	00:00:00 ... 24:00:00	Stop time for time period 3.	1 = 1 s (24:00:00 = 86400)
36.13	Start day3	Defines the week day on which time period 3 begins.	
	Monday	Time period 3 starts on Monday.	1
	Tuesday	Time period 3 starts on Tuesday.	2
	Wednesday	Time period 3 starts on Wednesday.	3
	Thursday	Time period 3 starts on Thursday.	4
	Friday	Time period 3 starts on Friday.	5
	Saturday	Time period 3 starts on Saturday.	6
	Sunday	Time period 3 starts on Sunday.	7
36.14	Stop day3	Defines the week day on which time period 3 ends.	
	Monday	Time period 3 ends on Monday.	1
	Tuesday	Time period 3 ends on Tuesday.	2
	Wednesday	Time period 3 ends on Wednesday.	3
	Thursday	Time period 3 ends on Thursday.	4
	Friday	Time period 3 ends on Friday.	5
	Saturday	Time period 3 ends on Saturday.	6

No.	Name/Value	Description	FbEq
	Sunday	Time period 3 ends on Sunday.	7
36.15	Start time4	Defines the start time for time period 4.	
	00:00:00 ... 24:00:00	Start time for time period 4.	1 = 1 s (24:00:00 = 86400)
36.16	Stop time4	Defines the stop time for time period 4.	
	00:00:00 ... 24:00:00	Stop time for time period 4.	1 = 1 s (24:00:00 = 86400)
36.17	Start day4	Defines the week day on which time period 4 begins.	
	Monday	Time period 4 starts on Monday.	1
	Tuesday	Time period 4 starts on Tuesday.	2
	Wednesday	Time period 4 starts on Wednesday.	3
	Thursday	Time period 4 starts on Thursday.	4
	Friday	Time period 4 starts on Friday.	5
	Saturday	Time period 4 starts on Saturday.	6
	Sunday	Time period 4 starts on Sunday.	7
36.18	Stop day4	Defines the week day on which time period 4 ends.	
	Monday	Time period 4 ends on Monday.	1
	Tuesday	Time period 4 ends on Tuesday.	2
	Wednesday	Time period 4 ends on Wednesday.	3
	Thursday	Time period 4 ends on Thursday.	4
	Friday	Time period 4 ends on Friday.	5
	Saturday	Time period 4 ends on Saturday.	6
	Sunday	Time period 1 ends on Sunday.	7
36.19	Boost signal	Boosting can be used to extend the timer enable signal for the time defined by parameter <a href="#">36.20 Boost time</a> . The boost time starts when the boost signal changes state from 1 to 0.	
	DI1	Digital input DI1 (as indicated by <a href="#">02.01 DI status</a> , bit 0).	1073742337
	DI2	Digital input DI2 (as indicated by <a href="#">02.01 DI status</a> , bit 1).	1073807873
	DI3	Digital input DI3 (as indicated by <a href="#">02.01 DI status</a> , bit 2).	1073873409
	DI4	Digital input DI4 (as indicated by <a href="#">02.01 DI status</a> , bit 3).	1073938945
	DI5	Digital input DI5 (as indicated by <a href="#">02.01 DI status</a> , bit 4).	1074004481
	Const	Bit pointer setting (see <a href="#">Terms and abbreviations</a> on page <a href="#">115</a> ).	-
	Pointer		
36.20	Boost time	Boost time. See parameter <a href="#">36.19 Boost signal</a> .	
	00:00:00 ... 24:00:00	Boost time.	1 = 1 s (24:00:00 = 86400)

No.	Name/Value	Description	FbEq												
36.21	Timed func1	<p>Selects which time periods (1...4) are used with timed function 1. Also determines whether boost is used with timed function 1.</p> <p>The parameter is a 16-bit word with each bit corresponding to a function. Whenever a bit is set to 1, the corresponding function is in use.</p> <p>The bits of the binary number correspond to the following functions:</p>													
<table border="1"> <thead> <tr> <th>Bit</th> <th>Function</th> </tr> </thead> <tbody> <tr> <td>0</td> <td>Timer1 ena (Time period 1 enable)</td> </tr> <tr> <td>1</td> <td>Timer2 ena (Time period 2 enable)</td> </tr> <tr> <td>2</td> <td>Timer3 ena (Time period 3 enable)</td> </tr> <tr> <td>3</td> <td>Timer4 ena (Time period 4 enable)</td> </tr> <tr> <td>4</td> <td>Boost ena (Boost enable)</td> </tr> </tbody> </table>				Bit	Function	0	Timer1 ena (Time period 1 enable)	1	Timer2 ena (Time period 2 enable)	2	Timer3 ena (Time period 3 enable)	3	Timer4 ena (Time period 4 enable)	4	Boost ena (Boost enable)
Bit	Function														
0	Timer1 ena (Time period 1 enable)														
1	Timer2 ena (Time period 2 enable)														
2	Timer3 ena (Time period 3 enable)														
3	Timer4 ena (Time period 4 enable)														
4	Boost ena (Boost enable)														
36.22	Timed func2	<p>Selects which time periods (1...4) are used with timed function 2. Also determines whether boost is used with timed function 2.</p> <p>The parameter is a 16-bit word with each bit corresponding to a function. Whenever a bit is set to 1, the corresponding function is in use.</p> <p>The bits of the binary number correspond to the following functions:</p>													
<table border="1"> <thead> <tr> <th>Bit</th> <th>Function</th> </tr> </thead> <tbody> <tr> <td>0</td> <td>Timer1 ena (Time period 1 enable)</td> </tr> <tr> <td>1</td> <td>Timer2 ena (Time period 2 enable)</td> </tr> <tr> <td>2</td> <td>Timer3 ena (Time period 3 enable)</td> </tr> <tr> <td>3</td> <td>Timer4 ena (Time period 4 enable)</td> </tr> <tr> <td>4</td> <td>Boost ena (Boost enable)</td> </tr> </tbody> </table>				Bit	Function	0	Timer1 ena (Time period 1 enable)	1	Timer2 ena (Time period 2 enable)	2	Timer3 ena (Time period 3 enable)	3	Timer4 ena (Time period 4 enable)	4	Boost ena (Boost enable)
Bit	Function														
0	Timer1 ena (Time period 1 enable)														
1	Timer2 ena (Time period 2 enable)														
2	Timer3 ena (Time period 3 enable)														
3	Timer4 ena (Time period 4 enable)														
4	Boost ena (Boost enable)														
36.23	Timed func3	<p>Selects which time periods (1...4) are used with timed function 3. Also determines whether boost is used with timed function 3.</p> <p>The parameter is a 16-bit word with each bit corresponding to a function. Whenever a bit is set to 1, the corresponding function is in use.</p> <p>The bits of the binary number correspond to the following functions:</p>													
<table border="1"> <thead> <tr> <th>Bit</th> <th>Function</th> </tr> </thead> <tbody> <tr> <td>0</td> <td>Timer1 ena (Time period 1 enable)</td> </tr> <tr> <td>1</td> <td>Timer2 ena (Time period 2 enable)</td> </tr> <tr> <td>2</td> <td>Timer3 ena (Time period 3 enable)</td> </tr> <tr> <td>3</td> <td>Timer4 ena (Time period 4 enable)</td> </tr> <tr> <td>4</td> <td>Boost ena (Boost enable)</td> </tr> </tbody> </table>				Bit	Function	0	Timer1 ena (Time period 1 enable)	1	Timer2 ena (Time period 2 enable)	2	Timer3 ena (Time period 3 enable)	3	Timer4 ena (Time period 4 enable)	4	Boost ena (Boost enable)
Bit	Function														
0	Timer1 ena (Time period 1 enable)														
1	Timer2 ena (Time period 2 enable)														
2	Timer3 ena (Time period 3 enable)														
3	Timer4 ena (Time period 4 enable)														
4	Boost ena (Boost enable)														

No.	Name/Value	Description	FbEq												
36.24	Timed func4	<p>Selects which time periods (1...4) are used with timed function 4. Also determines whether boost is used with timed function 4.</p> <p>The parameter is a 16-bit word with each bit corresponding to a function. Whenever a bit is set to 1, the corresponding function is in use.</p> <p>The bits of the binary number correspond to the following functions:</p>													
		<table border="1"> <thead> <tr> <th>Bit</th> <th>Function</th> </tr> </thead> <tbody> <tr> <td>0</td> <td>Timer1 ena (Time period 1 enable)</td> </tr> <tr> <td>1</td> <td>Timer2 ena (Time period 2 enable)</td> </tr> <tr> <td>2</td> <td>Timer3 ena (Time period 3 enable)</td> </tr> <tr> <td>3</td> <td>Timer4 ena (Time period 4 enable)</td> </tr> <tr> <td>4</td> <td>Boost ena (Boost enable)</td> </tr> </tbody> </table>	Bit	Function	0	Timer1 ena (Time period 1 enable)	1	Timer2 ena (Time period 2 enable)	2	Timer3 ena (Time period 3 enable)	3	Timer4 ena (Time period 4 enable)	4	Boost ena (Boost enable)	
Bit	Function														
0	Timer1 ena (Time period 1 enable)														
1	Timer2 ena (Time period 2 enable)														
2	Timer3 ena (Time period 3 enable)														
3	Timer4 ena (Time period 4 enable)														
4	Boost ena (Boost enable)														

<b>38 Flux ref</b>		Flux reference and <i>U/f</i> curve settings. See also section <a href="#">User-definable U/f curve</a> on page 77.	
38.01	Flux ref	Sets the flux reference (in percent of parameter <a href="#">99.08 Mot nom freq</a> ) at field weakening point.	
	0 ... 200%	Flux reference at field weakening point.	1 = 1%
38.03	<i>U/f</i> curve func	<p>Selects the form of the <i>U/f</i> (voltage/frequency) curve below the field weakening point.</p> <p><b>Note:</b> This functionality can be used in scalar control only, i.e. when <a href="#">99.05 Motor ctrl mode</a> is set to <i>Scalar</i>.</p>	
	Linear	Linear <i>U/f</i> curve. Recommended for constant-torque applications.	0
	Quadratic	Quadratic <i>U/f</i> curve. Recommended for centrifugal pump and fan applications.	1
	User	Custom <i>U/f</i> curve. The curve is formed by the points defined by parameters <a href="#">38.04</a> ... <a href="#">38.13</a> .	2
38.04	<i>U/f</i> curve freq1	Defines the frequency at the 1st point on the custom <i>U/f</i> curve in percent of parameter <a href="#">99.08 Mot nom freq</a> .	
	1 ... 500%	1st point, frequency.	1 = 1%
38.05	<i>U/f</i> curve freq2	Defines the frequency at the 2nd point on the custom <i>U/f</i> curve in percent of parameter <a href="#">99.08 Mot nom freq</a> .	
	1 ... 500%	2nd point, frequency.	1 = 1%
38.06	<i>U/f</i> curve freq3	Defines the frequency at the 3rd point on the custom <i>U/f</i> curve in percent of parameter <a href="#">99.08 Mot nom freq</a> .	
	1 ... 500%	3rd point, frequency.	1 = 1%
38.07	<i>U/f</i> curve freq4	Defines the frequency at the 4th point on the custom <i>U/f</i> curve in percent of parameter <a href="#">99.08 Mot nom freq</a> .	
	1 ... 500%	4th point, frequency.	1 = 1%
38.08	<i>U/f</i> curve freq5	Defines the frequency at the 5th point on the custom <i>U/f</i> curve in percent of parameter <a href="#">99.08 Mot nom freq</a> .	
	1 ... 500%	5th point, frequency.	1 = 1%
38.09	<i>U/f</i> curve volt1	Defines the voltage at the 1st point on the custom <i>U/f</i> curve in percent of parameter <a href="#">99.07 Mot nom voltage</a> .	
	0 ... 200%	1st point, voltage.	1 = 1%

No.	Name/Value	Description	FbEq
38.10	U/f curve volt2	Defines the voltage at the 2nd point on the custom <i>U/f</i> curve in percent of parameter <a href="#">99.07 Mot nom voltage</a> .	
	0 ... 200%	2nd point, voltage.	1 = 1%
38.11	U/f curve volt3	Defines the voltage at the 3rd point on the custom <i>U/f</i> curve in percent of parameter <a href="#">99.07 Mot nom voltage</a> .	
	0 ... 200%	3rd point, voltage.	1 = 1%
38.12	U/f curve volt4	Defines the voltage at the 4th point on the custom <i>U/f</i> curve in percent of parameter <a href="#">99.07 Mot nom voltage</a> .	
	0 ... 200%	4th point, voltage.	1 = 1%
38.13	U/f curve volt5	Defines the voltage at the 5th point on the custom <i>U/f</i> curve in percent of parameter <a href="#">99.07 Mot nom voltage</a> .	
	0 ... 200%	5th point, voltage.	1 = 1%
38.16	Flux ref pointer	Selects the source of the flux reference.	
	Pointer	Value pointer setting (see <a href="#">Terms and abbreviations</a> on page <a href="#">115</a> ).	-
<b>40 Motor control</b>		Motor control settings such as performance/noise optimization, slip gain, voltage reserve and IR compensation.	
40.01	Motor noise	An optimization setting for balancing between control performance and motor noise level.	
	Cyclic	Control performance optimized for cyclic load applications. <b>Note:</b> With this setting, the maximum motor cable length is shorter than with <a href="#">Default</a> .	0
	Low noise	Minimizes motor noise; control performance optimized for high (> 300 Hz) output frequencies. <b>Note:</b> Drive loadability is reduced with this setting and some derating must be applied if a certain constant output current is needed. This setting is not recommended for cyclic load applications. The maximum motor cable length is 50 m (164 ft) with drives up to 45 kW.	1
	Default	Control performance optimized for long motor cables.	2
	Custom	The minimum switching frequency is defined manually by parameter <a href="#">40.02 Sf ref</a> .	3
40.02	Sf ref	Defines the minimum switching frequency reference when parameter <a href="#">40.01 Motor noise</a> is set to <a href="#">Custom</a> . <b>Note:</b> The switching frequency limits of the hardware may prevent the drive control from accepting too high or low a value.	
	1.0 ... 8.0 kHz	Minimum switching frequency reference	1 = 1 kHz
40.03	Slip gain	Defines the slip gain which is used to improve the estimated motor slip. 100% means full slip gain; 0% means no slip gain. The default value is 100%. Other values can be used if a static speed error is detected despite of the full slip gain. <b>Example</b> (with nominal load and nominal slip of 40 rpm): A 1000 rpm constant speed reference is given to the drive. Despite of the full slip gain (= 100%), a manual tachometer measurement from the motor axis gives a speed value of 998 rpm. The static speed error is 1000 rpm - 998 rpm = 2 rpm. To compensate the error, the slip gain should be increased. At the 105% gain value, no static speed error exists (2 rpm / 40 rpm = 5%).	



No.	Name/Value	Description	FbEq
	0 ... 200%	Slip gain.	1 = 1%
40.04	Voltage reserve	<p>Defines the minimum allowed voltage reserve. When the voltage reserve has decreased to the set value, the drive enters the field weakening area.</p> <p>If the intermediate circuit DC voltage <math>U_{dc} = 550 \text{ V}</math> and the voltage reserve is 5%, the RMS value of the maximum output voltage in steady-state operation is <math>0.95 \times 550 \text{ V} / \sqrt{2} = 369 \text{ V}</math></p> <p>The dynamic performance of the motor control in the field weakening area can be improved by increasing the voltage reserve value, but the drive enters the field weakening area earlier.</p>	
	-4 ... 50%	Voltage reserve.	1 = 1%
40.07	IR-compensation	<p>Defines the relative output voltage boost at zero speed (IR compensation). The function is useful in applications with a high break-away torque where direct torque control (DTC mode) cannot be applied.</p> <p>See also section <a href="#">IR compensation for a scalar controlled drive</a> on page 75.</p>	
	0.00 ... 50.00%	Voltage boost at zero speed in percent of nominal motor voltage.	100 = 1%
40.10	Flux braking	Defines the level of braking power.	
	Disabled	Flux braking is disabled.	0
	Moderate	Flux level is limited during the braking. Deceleration time is longer compared to full braking.	1
	Full	Maximum braking power. Almost all available current is used to convert the mechanical braking energy to thermal energy in the motor.	2
40.11	Mmodel t adapt	Selects whether the temperature-dependent parameters (such as stator or rotor resistance) of the motor model adapt to actual (measured or estimated) temperature or not.	
	Disabled	Temperature adaptation of motor model disabled.	0
	Enabled	Temperature adaptation of motor model enabled.	1

No.	Name/Value	Description	FbEq						
<b>44 Maintenance</b>		Maintenance counter configuration. See also section <a href="#">Maintenance counters</a> on page 87.							
44.01	Ontime1 func	Configures on-time counter 1. This counter runs whenever the signal selected by parameter <a href="#">44.02 Ontime1 src</a> is on. After the limit set by parameter <a href="#">44.03 Ontime1 limit</a> is reached, an alarm specified by parameter <a href="#">44.04 Ontime1 alm sel</a> is given, and the counter reset. The current value of the counter is readable and resettable from parameter <a href="#">04.09 Counter ontime1</a> . Bit 0 of <a href="#">06.15 Counter status</a> indicates that the count has exceeded the limit.							
		<table border="1"> <thead> <tr> <th>Bit</th> <th>Function</th> </tr> </thead> <tbody> <tr> <td>0</td> <td>Counter mode 0 = Loop: If alarm is enabled by bit 1, the alarm stays active only for 10 seconds. 1 = Saturate: If alarm is enabled by bit 1, the alarm stays active until reset.</td> </tr> <tr> <td>1</td> <td>Alarm ena (Alarm enable) 0 = Disable: No alarm is given when limit is reached. 1 = Enable: Alarm is given when limit is reached.</td> </tr> </tbody> </table>	Bit	Function	0	Counter mode 0 = Loop: If alarm is enabled by bit 1, the alarm stays active only for 10 seconds. 1 = Saturate: If alarm is enabled by bit 1, the alarm stays active until reset.	1	Alarm ena (Alarm enable) 0 = Disable: No alarm is given when limit is reached. 1 = Enable: Alarm is given when limit is reached.	
Bit	Function								
0	Counter mode 0 = Loop: If alarm is enabled by bit 1, the alarm stays active only for 10 seconds. 1 = Saturate: If alarm is enabled by bit 1, the alarm stays active until reset.								
1	Alarm ena (Alarm enable) 0 = Disable: No alarm is given when limit is reached. 1 = Enable: Alarm is given when limit is reached.								
44.02	Ontime1 src	Selects the signal to be monitored by on-time counter 1. See parameter <a href="#">44.01 Ontime1 func</a> .							
	RO1	Relay output RO1 (as indicated by <a href="#">02.02 RO status</a> , bit 0).	1073742338						
	Running	Bit 3 of <a href="#">06.01 Status word1</a> (see page 133).	1073939969						
	Charged	Bit 9 of <a href="#">06.02 Status word2</a> (see page 134).	1074333186						
	Const	Bit pointer setting (see <a href="#">Terms and abbreviations</a> on page 115).	-						
	Pointer								
44.03	Ontime1 limit	Sets the alarm limit for on-time counter 1. See parameter <a href="#">44.01 Ontime1 func</a> .							
	0...2147483647 s	Alarm limit for on-time counter 1.							
44.04	Ontime1 alm sel	Selects the alarm for on-time counter 1. See parameter <a href="#">44.01 Ontime1 func</a> .							
	On-time1	Pre-selectable alarm for on-time counter 1.	0						
	Device clean	Pre-selectable alarm for on-time counter 1.	1						
	Add cool fan	Pre-selectable alarm for on-time counter 1.	2						
	Cabinet fan	Pre-selectable alarm for on-time counter 1.	3						
	Dc-capacitor	Pre-selectable alarm for on-time counter 1.	4						
	Mot bearing	Pre-selectable alarm for on-time counter 1.	5						

No.	Name/Value	Description	FbEq						
44.05	Ontime2 func	<p>Configures on-time counter 2. This counter runs whenever the signal selected by parameter <a href="#">44.06 Ontime2 src</a> is on. After the limit set by parameter <a href="#">44.07 Ontime2 limit</a> is reached, an alarm specified by parameter <a href="#">44.08 Ontime2 alm sel</a> is given, and the counter reset.</p> <p>The current value of the counter is readable and resettable from parameter <a href="#">04.10 Counter ontime2</a>. Bit 1 of <a href="#">06.15 Counter status</a> indicates that the count has exceeded the limit.</p>							
		<table border="1"> <thead> <tr> <th>Bit</th> <th>Function</th> </tr> </thead> <tbody> <tr> <td>0</td> <td>           Counter mode            0 = Loop: If alarm is enabled by bit 1, the alarm stays active only for 10 seconds.            1 = Saturate: If alarm is enabled by bit 1, the alarm stays active until reset.         </td> </tr> <tr> <td>1</td> <td>           Alarm ena (Alarm enable)            0 = Disable: No alarm is given when limit is reached.            1 = Enable: Alarm is given when limit is reached.         </td> </tr> </tbody> </table>	Bit	Function	0	Counter mode 0 = Loop: If alarm is enabled by bit 1, the alarm stays active only for 10 seconds. 1 = Saturate: If alarm is enabled by bit 1, the alarm stays active until reset.	1	Alarm ena (Alarm enable) 0 = Disable: No alarm is given when limit is reached. 1 = Enable: Alarm is given when limit is reached.	
Bit	Function								
0	Counter mode 0 = Loop: If alarm is enabled by bit 1, the alarm stays active only for 10 seconds. 1 = Saturate: If alarm is enabled by bit 1, the alarm stays active until reset.								
1	Alarm ena (Alarm enable) 0 = Disable: No alarm is given when limit is reached. 1 = Enable: Alarm is given when limit is reached.								
44.06	Ontime2 src	Selects the signal to be monitored by on-time counter 2. See parameter <a href="#">44.05 Ontime2 func</a> .							
	RO1	Relay output RO1 (as indicated by <a href="#">02.02 RO status</a> , bit 0).	1073742338						
	Running	Bit 3 of <a href="#">06.01 Status word1</a> (see page <a href="#">133</a> ).	1073939969						
	Charged	Bit 9 of <a href="#">06.02 Status word2</a> (see page <a href="#">134</a> ).	1074333186						
	Const	Bit pointer setting (see <a href="#">Terms and abbreviations</a> on page <a href="#">115</a> ).	-						
	Pointer								
44.07	Ontime2 limit	Sets the alarm limit for on-time counter 2. See parameter <a href="#">44.05 Ontime2 func</a> .							
	0 ... 2147483647 s	Alarm limit for on-time counter 2.	1 = 1 s						
44.08	Ontime2 alm sel	Selects the alarm for on-time counter 2. See parameter <a href="#">44.05 Ontime2 func</a> .							
	On-time2	Pre-selectable alarm for on-time counter 2.	0						
	Device clean	Pre-selectable alarm for on-time counter 2.	1						
	Add cool fan	Pre-selectable alarm for on-time counter 2.	2						
	Cabinet fan	Pre-selectable alarm for on-time counter 2.	3						
	Dc-capacitor	Pre-selectable alarm for on-time counter 2.	4						
	Mot bearing	Pre-selectable alarm for on-time counter 2.	5						

No.	Name/Value	Description	FbEq						
44.09	Edge count1 func	<p>Configures rising edge counter 1. This counter is incremented every time the signal selected by parameter <a href="#">44.10 Edge count1 src</a> switches on (unless a divisor value is applied – see parameter <a href="#">44.12 Edge count1 div</a>). After the limit set by parameter <a href="#">44.11 Edge count1 lim</a> is reached, an alarm specified by parameter <a href="#">44.13 Edg cnt1 alm sel</a> is given, and the counter reset.</p> <p>The current value of the counter is readable and resettable from parameter <a href="#">04.11 Counter edge1</a>. Bit 2 of <a href="#">06.15 Counter status</a> indicates that the count has exceeded the limit.</p>							
<table border="1"> <thead> <tr> <th>Bit</th> <th>Function</th> </tr> </thead> <tbody> <tr> <td>0</td> <td>           Counter mode            0 = Loop: If alarm is enabled by bit 1, the alarm stays active only for 10 seconds.            1 = Saturate: If alarm is enabled by bit 1, the alarm stays active until reset.         </td> </tr> <tr> <td>1</td> <td>           Alarm ena (Alarm enable)            0 = Disable: No alarm is given when limit is reached.            1 = Enable: Alarm is given when limit is reached.         </td> </tr> </tbody> </table>				Bit	Function	0	Counter mode 0 = Loop: If alarm is enabled by bit 1, the alarm stays active only for 10 seconds. 1 = Saturate: If alarm is enabled by bit 1, the alarm stays active until reset.	1	Alarm ena (Alarm enable) 0 = Disable: No alarm is given when limit is reached. 1 = Enable: Alarm is given when limit is reached.
Bit	Function								
0	Counter mode 0 = Loop: If alarm is enabled by bit 1, the alarm stays active only for 10 seconds. 1 = Saturate: If alarm is enabled by bit 1, the alarm stays active until reset.								
1	Alarm ena (Alarm enable) 0 = Disable: No alarm is given when limit is reached. 1 = Enable: Alarm is given when limit is reached.								
44.10	Edge count1 src	Selects the signal to be monitored by rising edge counter 1. See parameter <a href="#">44.09 Edge count1 func</a> .							
	RO1	Relay output RO1 (as indicated by <a href="#">02.02 RO status</a> , bit 0).	1073742338						
	Running	Bit 3 of <a href="#">06.01 Status word1</a> (see page 133).	1073939969						
	Charged	Bit 9 of <a href="#">06.02 Status word2</a> (see page 134).	1074333186						
	Const	Bit pointer setting (see <a href="#">Terms and abbreviations</a> on page 115).	-						
	Pointer								
44.11	Edge count1 lim	Sets the alarm limit for rising edge counter 1. See parameter <a href="#">44.09 Edge count1 func</a> .							
	0 ... 2147483647	Alarm limit for rising edge counter 1.	1 = 1						
44.12	Edge count1 div	Divisor for rising edge counter 1. Determines how many rising edges increment the counter by 1.							
	1 ... 2147483647	Divisor for rising edge counter 1.	1 = 1						
44.13	Edg cnt1 alm sel	Selects the alarm for rising edge counter 1. See parameter <a href="#">44.09 Edge count1 func</a> .							
	Edge count1	Pre-selectable alarm for rising edge counter 1.	0						
	Main cntactr	Pre-selectable alarm for rising edge counter 1.	1						
	Output relay	Pre-selectable alarm for rising edge counter 1.	2						
	Motor starts	Pre-selectable alarm for rising edge counter 1.	3						
	Power ups	Pre-selectable alarm for rising edge counter 1.	4						
	Dc-charge	Pre-selectable alarm for rising edge counter 1.	5						

No.	Name/Value	Description	FbEq						
44.14	Edge count2 func	<p>Configures rising edge counter 2. The counter is incremented every time the signal selected by parameter <a href="#">44.15 Edge count2 src</a> switches on (unless a divisor value is applied – see parameter <a href="#">44.17 Edge count2 div</a>). After the limit set by parameter <a href="#">44.16 Edge count2 lim</a> is reached, an alarm specified by parameter <a href="#">44.22 Edg cnt2 alm sel</a> is given and the counter is reset.</p> <p>The current value of the counter is readable and resettable from parameter <a href="#">04.12 Counter edge2</a>. Bit 3 of <a href="#">06.15 Counter status</a> indicates that the count has exceeded the limit.</p>							
		<table border="1"> <thead> <tr> <th>Bit</th> <th>Function</th> </tr> </thead> <tbody> <tr> <td>0</td> <td>           Counter mode            0 = Loop: If alarm is enabled by bit 1, the alarm stays active only for 10 seconds.            1 = Saturate: If alarm is enabled by bit 1, the alarm stays active until reset.         </td> </tr> <tr> <td>1</td> <td>           Alarm ena (Alarm enable)            0 = Disable: No alarm is given when limit is reached.            1 = Enable: Alarm is given when limit is reached.         </td> </tr> </tbody> </table>	Bit	Function	0	Counter mode 0 = Loop: If alarm is enabled by bit 1, the alarm stays active only for 10 seconds. 1 = Saturate: If alarm is enabled by bit 1, the alarm stays active until reset.	1	Alarm ena (Alarm enable) 0 = Disable: No alarm is given when limit is reached. 1 = Enable: Alarm is given when limit is reached.	
Bit	Function								
0	Counter mode 0 = Loop: If alarm is enabled by bit 1, the alarm stays active only for 10 seconds. 1 = Saturate: If alarm is enabled by bit 1, the alarm stays active until reset.								
1	Alarm ena (Alarm enable) 0 = Disable: No alarm is given when limit is reached. 1 = Enable: Alarm is given when limit is reached.								
44.15	Edge count2 src	Selects the signal to be monitored by rising edge counter 2. See parameter <a href="#">44.14 Edge count2 func</a> .							
	RO1	Relay output RO1 (as indicated by <a href="#">02.02 RO status</a> , bit 0).	1073742338						
	Running	Bit 3 of <a href="#">06.01 Status word1</a> (see page <a href="#">133</a> ).	1073939969						
	Charged	Bit 9 of <a href="#">06.02 Status word2</a> (see page <a href="#">134</a> ).	1074333186						
	Const	Bit pointer setting (see <a href="#">Terms and abbreviations</a> on page <a href="#">115</a> ).	-						
	Pointer								
44.16	Edge count2 lim	Sets the alarm limit for rising edge counter 1. See parameter <a href="#">44.14 Edge count2 func</a> .							
	0 ... 2147483647	Alarm limit for rising edge counter 2.	1 = 1						
44.17	Edge count2 div	Divisor for rising edge counter 2. Determines how many rising edges increment the counter by 1.							
	1 ... 2147483647	Divisor for rising edge counter 2.	1 = 1						
44.18	Edg cnt2 alm sel	Selects the alarm for rising edge counter 2. See parameter <a href="#">44.14 Edge count2 func</a> .							
	Edge count2	Pre-selectable alarm for rising edge counter 2.	0						
	Main cntactr	Pre-selectable alarm for rising edge counter 2.	1						
	Output relay	Pre-selectable alarm for rising edge counter 2.	2						
	Motor starts	Pre-selectable alarm for rising edge counter 2.	3						
	Power ups	Pre-selectable alarm for rising edge counter 2.	4						
	Dc-charge	Pre-selectable alarm for rising edge counter 2.	5						

No.	Name/Value	Description	FbEq						
44.19	Val count1 func	<p>Configures value counter 1. This counter measures, by integration, the area below the signal selected by parameter <a href="#">44.20 Val count1 src</a>. When the total area exceeds the limit set by parameter <a href="#">44.21 Val count1 lim</a>, an alarm is given (if enabled by bit 1 of this parameter).</p> <p>The signal is sampled at 0.5-second intervals. Note that the scaled (see the "FbEq" column at the signal in question) value of the signal is used.</p> <p>The current value of the counter is readable and resettable from parameter <a href="#">04.13 Counter value1</a>. Bit 4 of <a href="#">06.15 Counter status</a> indicates that the counter has exceeded the limit.</p>							
<table border="1"> <thead> <tr> <th>Bit</th> <th>Function</th> </tr> </thead> <tbody> <tr> <td>0</td> <td>                     Counter mode                      0 = Loop: If alarm is enabled by bit 1, the alarm stays active only for 10 seconds.                      1 = Saturate: If alarm is enabled by bit 1, the alarm stays active until reset.                 </td> </tr> <tr> <td>1</td> <td>                     Alarm ena (Alarm enable)                      0 = Disable: No alarm is given when limit is reached.                      1 = Enable: Alarm is given when limit is reached.                 </td> </tr> </tbody> </table>				Bit	Function	0	Counter mode 0 = Loop: If alarm is enabled by bit 1, the alarm stays active only for 10 seconds. 1 = Saturate: If alarm is enabled by bit 1, the alarm stays active until reset.	1	Alarm ena (Alarm enable) 0 = Disable: No alarm is given when limit is reached. 1 = Enable: Alarm is given when limit is reached.
Bit	Function								
0	Counter mode 0 = Loop: If alarm is enabled by bit 1, the alarm stays active only for 10 seconds. 1 = Saturate: If alarm is enabled by bit 1, the alarm stays active until reset.								
1	Alarm ena (Alarm enable) 0 = Disable: No alarm is given when limit is reached. 1 = Enable: Alarm is given when limit is reached.								
44.20	Val count1 src	Selects the signal to be monitored by value counter 1. See parameter <a href="#">44.19 Val count1 func</a> .							
	Speed rpm	<a href="#">01.01 Motor speed rpm</a> (see page 118).	1073742081						
	Pointer	Value pointer setting (see <a href="#">Terms and abbreviations</a> on page 115).	-						
44.21	Val count1 lim	Sets the alarm limit for value counter 1. See parameter <a href="#">44.19 Val count1 func</a> .							
	0 ... 2147483647	Alarm limit for value counter 1.	1 = 1						
44.22	Val count1 div	Divisor for value counter 1. The value of the monitored signal is divided by this value before integration.							
	1 ... 2147483647	Divisor for value counter 1.	1 = 1						
44.23	Val cnt1 alm sel	Selects the alarm for value counter 1. See parameter <a href="#">44.19 Val count1 func</a> .							
	Value1	Pre-selectable alarm for value counter 1.	0						
	Mot bearing	Pre-selectable alarm for value counter 1.	1						

No.	Name/Value	Description	FbEq						
44.24	Val count2 func	<p>Configures value counter 2. This counter measures, by integration, the area below the signal selected by parameter <a href="#">44.25 Val count2 src</a>. When the total area exceeds the limit set by parameter <a href="#">44.26 Val count2 lim</a>, an alarm is given (if enabled by bit 1 of this parameter).</p> <p>The signal is sampled at 1-second intervals. Note that the scaled (see the “FbEq” column at the signal in question) value of the signal is used.</p> <p>The current value of the counter is readable and resettable from parameter <a href="#">04.14 Counter value2</a>. Bit 5 of <a href="#">06.15 Counter status</a> indicates that the counter has exceeded the limit.</p>							
		<table border="1"> <thead> <tr> <th>Bit</th> <th>Function</th> </tr> </thead> <tbody> <tr> <td>0</td> <td>Counter mode 0 = Loop: If alarm is enabled by bit 1, the alarm stays active only for 10 seconds. 1 = Saturate: If alarm is enabled by bit 1, the alarm stays active until reset.</td> </tr> <tr> <td>1</td> <td>Alarm ena (Alarm enable) 0 = Disable: No alarm is given when limit is reached. 1 = Enable: Alarm is given when limit is reached.</td> </tr> </tbody> </table>	Bit	Function	0	Counter mode 0 = Loop: If alarm is enabled by bit 1, the alarm stays active only for 10 seconds. 1 = Saturate: If alarm is enabled by bit 1, the alarm stays active until reset.	1	Alarm ena (Alarm enable) 0 = Disable: No alarm is given when limit is reached. 1 = Enable: Alarm is given when limit is reached.	
Bit	Function								
0	Counter mode 0 = Loop: If alarm is enabled by bit 1, the alarm stays active only for 10 seconds. 1 = Saturate: If alarm is enabled by bit 1, the alarm stays active until reset.								
1	Alarm ena (Alarm enable) 0 = Disable: No alarm is given when limit is reached. 1 = Enable: Alarm is given when limit is reached.								
44.25	Val count2 src	Selects the signal to be monitored by value counter 2. See parameter <a href="#">44.24 Val count2 func</a> .							
	Speed rpm	<a href="#">01.01 Motor speed rpm</a> (see page 118).	1073742081						
	Pointer	Value pointer setting (see <a href="#">Terms and abbreviations</a> on page 115).	-						
44.26	Val count2 lim	Sets the alarm limit for value counter 2. See parameter <a href="#">44.24 Val count2 func</a> .							
	0...2147483647	Alarm limit for value counter 2.	1 = 1						
44.27	Val count2 div	Divisor for value counter 2. The value of the monitored signal is divided by this value before integration.							
	1...2147483647	Divisor for value counter 2.	1 = 1						
44.28	Val cnt2 alm sel	Selects the alarm for value counter 2. See parameter <a href="#">44.24 Val count2 func</a> .							
	Value2	Pre-selectable alarm for value counter 2.	0						
	Mot bearing	Pre-selectable alarm for value counter 2.	1						
44.29	Fan ontime lim	Sets the limit for the cooling fan on-time counter. The counter monitors signal <a href="#">01.28 Fan on-time</a> (see page 118). When the signal reaches the limit, alarm <a href="#">2056 COOLING FAN</a> is given.							
	0.00 ... 35791394.11 h	Alarm limit for cooling fan on-time.	1 = 1 min						
44.30	Runtime lim	Sets the limit for the drive run-time counter. The counter monitors signal <a href="#">01.27 Run-time counter</a> (see page 118). When the signal reaches the limit, the alarm specified by parameter <a href="#">44.31 Runtime alm sel</a> is given.							
	0.00 ... 35791394.11 h	Alarm limit for the drive run-time counter.	1 = 1 min						
44.31	Runtime alm sel	Selects the alarm for the drive run time counter.							
	Device clean	Pre-selectable alarm for the drive run time counter.	1						
	Add cool fan	Pre-selectable alarm for the drive run time counter.	2						
	Cabinet fan	Pre-selectable alarm for the drive run time counter.	3						

No.	Name/Value	Description	FbEq
	Dc-capacitor	Pre-selectable alarm for the drive run time counter.	4
	Mot bearing	Pre-selectable alarm for the drive run time counter.	5
44.32	kWh inv lim	Sets the limit for the energy counter. The counter monitors signal <i>01.24 kWh inverter</i> (see page 118). When the signal reaches the limit, the alarm specified by parameter <i>44.33 kWh inv alm sel</i> is given.	
	0...2147483647 kWh	Alarm limit for the energy counter.	1 = 1 kWh
44.33	kWh inv alm sel	Selects the alarm for the energy counter.	
	Device clean	Pre-selectable alarm for the energy counter.	1
	Add cool fan	Pre-selectable alarm for the energy counter.	2
	Cabinet fan	Pre-selectable alarm for the energy counter.	3
	Dc-capacitor	Pre-selectable alarm for the energy counter.	4
	Mot bearing	Pre-selectable alarm for the energy counter.	5
44.34	Counter reset	Active counter reset clears all (on-time, rising edge or value) saturated alarms.	
	DI4	Digital input DI4 (as indicated by <i>02.01 DI status</i> , bit 3).	1073938945
	DI5	Digital input DI5 (as indicated by <i>02.01 DI status</i> , bit 4).	1074004481
	Const	Bit pointer setting (see <i>Terms and abbreviations</i> on page 115).	-
	Pointer		
<b>45 Energy optimising</b>		Energy optimization settings. See also section <i>Energy savings calculator</i> on page 86.	
45.01	Energy optim	Enables/disables the energy optimization function. The function optimizes the flux so that the total energy consumption and motor noise level are reduced when the drive operates below the nominal load. The total efficiency (motor and drive) can be improved by 1...10% depending on load torque and speed. <b>Note:</b> Energy optimization cannot be used with synchronous reluctance motors.	
	Disable	Energy optimization disabled.	0
	Enable	Energy optimization enabled.	1
45.02	Energy tariff1	Price of energy per kWh. Used for reference when savings are calculated. See parameters <i>01.35 Saved energy</i> , <i>01.36 Saved amount</i> and <i>01.37 Saved CO2</i> .	
	0.00 ... 21474836.47	Price of energy per kWh.	1 = 1
45.06	E tariff unit	Specifies the currency used for the savings calculation.	
	Local	The currency is determined by the setting of parameter <i>99.01 Language</i> .	0
	Eur	Euro.	1
	Usd	US dollar.	2



No.	Name/Value	Description	FbEq
45.07	CO2 Conv factor	Conversion factor for converting energy into CO <sub>2</sub> emissions (kg/kWh or tn/MWh). Used for multiplying the saved energy in MWh to calculate the value of signal <a href="#">01.37 Saved CO2</a> (reduction in carbon dioxide emissions in metric tons). $01.37 \text{ Saved CO2} = 01.35 \text{ Saved energy (MWh)} \times 45.07 \text{ CO2 Conv factor (tn/MWh)}$ .	
	0.0 ... 10.0	Conversion factor for converting energy into CO <sub>2</sub> emissions (kg/kWh or tn/MWh).	1 = 1
45.08	Pump ref power	Pump power when connected directly to supply. Used for reference when energy savings are calculated. See parameters <a href="#">01.35 Saved energy</a> , <a href="#">01.36 Saved amount</a> and <a href="#">01.37 Saved CO2</a> .	
	0.0 ... 1000.0%	Pump power in percent of nominal motor power.	1 = 1
45.09	Energy reset	Resets the energy counters <a href="#">01.35 Saved energy</a> , <a href="#">01.36 Saved amount</a> and <a href="#">01.37 Saved CO2</a> .	
	Done	Reset not requested (normal operation).	0
	Reset	Reset energy counters. The value reverts automatically to <a href="#">Done</a> .	1
<b>47 Voltage ctrl</b>		Overvoltage and undervoltage control settings. See also <a href="#">DC voltage control</a> on page 81.	
47.01	Overvolt ctrl	Enables the overvoltage control of the intermediate DC link. Fast braking of a high inertia load causes the voltage to rise to the overvoltage control limit. To prevent the DC voltage from exceeding the limit, the overvoltage controller automatically decreases the braking torque.	
	Disable	Overvoltage control disabled.	0
	Enable	Overvoltage control enabled.	1
47.02	Undervolt ctrl	Enables the undervoltage control of the intermediate DC link. If the DC voltage drops due to input power cut off, the undervoltage controller will automatically decrease the motor torque in order to keep the voltage above the lower limit. By decreasing the motor torque, the inertia of the load will cause regeneration back to the drive, keeping the DC link charged and preventing an undervoltage trip until the motor coasts to stop. This will act as a power-loss ride-through functionality in systems with high inertia.	
	Disable	Undervoltage control disabled.	0
	Enable	Undervoltage control enabled.	1
47.03	Sup volt auto Id	Enables the auto-identification of the supply voltage.	
	Disable	Auto-identification of supply voltage disabled.	0
	Enable	Auto-identification of supply voltage enabled.	1
47.04	Supply voltage	Defines the nominal supply voltage. Used if auto-identification of the supply voltage is not enabled by parameter <a href="#">47.03 Sup volt auto Id</a> .	
	0 ... 1000 V	Nominal supply voltage.	10 = 1 V

No.	Name/Value	Description	FbEq
<b>49 Data storage</b>		Data storage parameters reserved for the user. These parameters can be written to and read from using other parameters' pointer settings. Four 16-bit and four 32-bit storage parameters are available.	
49.01	Data storage1	Data storage parameter 1.	
	-32768 ... 32767	16-bit data.	1 = 1
49.02	Data storage2	Data storage parameter 2.	
	-32768 ... 32767	16-bit data.	1 = 1
49.03	Data storage3	Data storage parameter 3.	
	-32768 ... 32767	16-bit data.	1 = 1
49.04	Data storage4	Data storage parameter 4.	
	-32768 ... 32767	16-bit data.	1 = 1
49.05	Data storage5	Data storage parameter 5.	
	-2147483647 ... 2147483647	32-bit data.	1 = 1
49.06	Data storage6	Data storage parameter 6.	
	-2147483647 ... 2147483647	32-bit data.	1 = 1
49.07	Data storage7	Data storage parameter 7.	
	-2147483647 ... 2147483647	32-bit data.	1 = 1
49.08	Data storage8	Data storage parameter 8.	
	-2147483647 ... 2147483647	32-bit data.	1 = 1
<b>50 Fieldbus</b>		Settings for configuration of communication via a fieldbus adapter. See also chapter <a href="#">Control through a fieldbus adapter</a> on page 383.	
50.01	FBA enable	Enables communication between the drive and fieldbus adapter.	
	Disable	Communication between the drive and fieldbus adapter disabled.	0
	Enable	Communication between the drive and fieldbus adapter enabled.	1
50.02	Comm loss func	Selects how the drive reacts upon a fieldbus communication break. The time delay is defined by parameter <a href="#">50.03 Comm loss t out</a> . Parameter <a href="#">50.21 Comm loss enable</a> defines when the monitoring of fieldbus communication is enabled.	
	No	No action.	0
	Fault	Upon a communication break, the drive trips on fault <a href="#">FIELD BUS COMM (0x7510)</a> and coasts to stop.	1
	Spd ref Safe	Upon a communication break, the drive generates alarm <a href="#">FIELD BUS COMM (0x7510)</a> and sets the speed to the value defined by parameter <a href="#">30.02 Speed ref safe</a> .	2
		 <b>WARNING!</b> Make sure that it is safe to continue operation in case of a communication break.	

No.	Name/Value	Description	FbEq
	Last speed	Upon a communication break, the drive generates alarm <a href="#">FIELDBUS COMM (0x7510)</a> and freezes the speed to the level the drive was operating at. The speed is determined by the average speed over the previous 10 seconds.  <b>WARNING!</b> Make sure that it is safe to continue operation in case of a communication break.	3
50.03	Comm loss t out	Defines the time delay before the action defined by parameter <a href="#">50.02 Comm loss func</a> is taken. Time count starts when the link fails to update the message.	
	0.3 ... 6553.5 s	Time delay.	10 = 1 s
50.04	FBA ref1 modesel	Selects the fieldbus reference FBA REF1 scaling and the actual value, which is sent to the fieldbus (FBA ACT1).	
	Raw data	No scaling (i.e. data is transmitted without scaling). Source for the actual value, which is sent to the fieldbus, is selected by parameter <a href="#">50.06 FBA act1 tr src</a> .	0
	1	Reserved.	1
	Speed	Fieldbus adapter module uses speed reference scaling. Speed reference scaling is defined by the used fieldbus profile (e.g. with ABB Drives Profile integer value 20000 corresponds to parameter <a href="#">19.01 Speed scaling</a> value). Signal <a href="#">01.01 Motor speed rpm</a> is sent to the fieldbus as an actual value. See the User's Manual of the appropriate fieldbus adapter module.	2
50.05	FBA ref2 modesel	Selects the fieldbus reference FBA REF2 scaling. See parameter <a href="#">50.04 FBA ref1 modesel</a> .	
	Raw data	See parameter <a href="#">50.04 FBA ref1 modesel</a> .	0
	1	Reserved.	1
	Speed	See parameter <a href="#">50.04 FBA ref1 modesel</a> .	2
50.06	FBA act1 tr src	Selects the source for fieldbus actual value 1 when parameter <a href="#">50.04 FBA ref1 modesel</a> / <a href="#">50.05 FBA ref2 modesel</a> is set to <a href="#">Raw data</a> .	
	Pointer	Value pointer setting (see <a href="#">Terms and abbreviations</a> on page <a href="#">115</a> ).	-
50.07	FBA act2 tr src	Selects the source for fieldbus actual value 2 when parameter <a href="#">50.04 FBA ref1 modesel</a> / <a href="#">50.05 FBA ref2 modesel</a> is set to <a href="#">Raw data</a> .	
	Pointer	Value pointer setting (see <a href="#">Terms and abbreviations</a> on page <a href="#">115</a> ).	-
50.08	FBA sw bit12 src	Selects the source for freely programmable fieldbus status word bit 28 ( <a href="#">02.24 FBA main sw</a> bit 28). Note that this functionality may not be supported by the fieldbus communication profile.	
	Const	Bit pointer setting (see <a href="#">Terms and abbreviations</a> on page <a href="#">115</a> ).	-
	Pointer		
50.09	FBA sw bit13 src	Selects the source for freely programmable fieldbus status word bit 29 ( <a href="#">02.24 FBA main sw</a> bit 29). Note that this functionality may not be supported by the fieldbus communication profile.	
	Const	Bit pointer setting (see <a href="#">Terms and abbreviations</a> on page <a href="#">115</a> ).	-
	Pointer		

No.	Name/Value	Description	FbEq												
50.10	FBA sw bit14 src	Selects the source for freely programmable fieldbus status word bit 30 ( <a href="#">02.24 FBA main sw</a> bit 30). Note that this functionality may not be supported by the fieldbus communication profile.													
	Const	Bit pointer setting (see <a href="#">Terms and abbreviations</a> on page <a href="#">115</a> ).	-												
	Pointer														
50.11	FBA sw bit15 src	Selects the source for freely programmable fieldbus status word bit 31 ( <a href="#">02.24 FBA main sw</a> bit 31). Note that this functionality may not be supported by the fieldbus communication profile.													
	Const	Bit pointer setting (see <a href="#">Terms and abbreviations</a> on page <a href="#">115</a> ).	-												
	Pointer														
50.12	FB comm speed	<p>Selects the fieldbus communication speed. Raising the speed increases the CPU load. The table below shows the read/write intervals for cyclic and acyclic data with each parameter setting.</p> <table border="1"> <thead> <tr> <th>Selection</th> <th>Cyclic*</th> <th>Acyclic**</th> </tr> </thead> <tbody> <tr> <td>Low</td> <td>10 ms</td> <td>10 ms</td> </tr> <tr> <td>Normal</td> <td>2 ms</td> <td>10 ms</td> </tr> <tr> <td>High</td> <td>500 us</td> <td>2 ms</td> </tr> </tbody> </table> <p>*Cyclic data consists of fieldbus CW and SW, Ref1 and Ref2, and Act1 and Act2.  **Acyclic data consists of the parameter data mapped to parameter groups <a href="#">52 FBA data in</a> and <a href="#">53 FBA data out</a>.</p>	Selection	Cyclic*	Acyclic**	Low	10 ms	10 ms	Normal	2 ms	10 ms	High	500 us	2 ms	
Selection	Cyclic*	Acyclic**													
Low	10 ms	10 ms													
Normal	2 ms	10 ms													
High	500 us	2 ms													
	Low	Low speed selected.	0												
	Normal	Normal speed selected.	1												
	High	High speed selected.	2												
50.15	FBA cw used	<p>Selects the fieldbus Control Word which controls the drive.</p> <ul style="list-style-type: none"> <li>For fieldbus control through a fieldbus adapter module, select <a href="#">02.22 FBA main cw</a>.</li> <li>For fieldbus control through the embedded fieldbus interface, select <a href="#">02.36 EFB main cw</a>.</li> </ul>													
	Pointer	Value pointer setting (see <a href="#">Terms and abbreviations</a> on page <a href="#">115</a> ).	-												
50.20	Fb main sw func	Selects the rule on the basis of which the drive defines the value for <a href="#">02.24 FBA main sw</a> bit 1 (Enabled).													
		<table border="1"> <thead> <tr> <th>Bit</th> <th>Name</th> <th>Information</th> </tr> </thead> <tbody> <tr> <td rowspan="2">0</td> <td rowspan="2">Run enable func</td> <td>1 = Parameter only: Bit 1 of <a href="#">02.24 FBA main sw</a> is set to 1 whenever the external run enable signal (par. <a href="#">10.11 Run enable</a>) is 1.</td> </tr> <tr> <td>0 = Param AND Fb cw: Bit 1 of <a href="#">02.24 FBA main sw</a> is set to 1 whenever both the external run enable signal (par. <a href="#">10.11 Run enable</a>) AND <a href="#">02.22 FBA main cw</a> bit 7 (Run enable) are 1.</td> </tr> </tbody> </table>	Bit	Name	Information	0	Run enable func	1 = Parameter only: Bit 1 of <a href="#">02.24 FBA main sw</a> is set to 1 whenever the external run enable signal (par. <a href="#">10.11 Run enable</a> ) is 1.	0 = Param AND Fb cw: Bit 1 of <a href="#">02.24 FBA main sw</a> is set to 1 whenever both the external run enable signal (par. <a href="#">10.11 Run enable</a> ) AND <a href="#">02.22 FBA main cw</a> bit 7 (Run enable) are 1.						
Bit	Name	Information													
0	Run enable func	1 = Parameter only: Bit 1 of <a href="#">02.24 FBA main sw</a> is set to 1 whenever the external run enable signal (par. <a href="#">10.11 Run enable</a> ) is 1.													
		0 = Param AND Fb cw: Bit 1 of <a href="#">02.24 FBA main sw</a> is set to 1 whenever both the external run enable signal (par. <a href="#">10.11 Run enable</a> ) AND <a href="#">02.22 FBA main cw</a> bit 7 (Run enable) are 1.													

No.	Name/Value	Description	FbEq											
50.21	Comm loss enable	<p>Activates fieldbus communication monitoring for control location EXT1 or EXT2, or both. The drive can detect a fieldbus communication break ONLY when it is in a control location where the monitoring is enabled. The action taken in the case of a detected communication break is defined by parameter <a href="#">50.02 Comm loss func</a>.</p> <p>When both control locations are selected, the monitoring is always done. The functionality does not take into account if the fieldbus is actually used for start/stop, reference, and so on. The communication is not monitored in the local control mode.</p> <p>By default, the monitoring is enabled in both control locations as a safety measure.</p>												
<table border="1"> <thead> <tr> <th>Bit</th> <th>Name</th> <th>Information</th> </tr> </thead> <tbody> <tr> <td rowspan="2">0</td> <td rowspan="2">EXT1</td> <td>0 = Communication break monitoring disabled in control location EXT1.</td> </tr> <tr> <td>1 = Communication break monitoring enabled in control location EXT1.</td> </tr> <tr> <td rowspan="2">1</td> <td rowspan="2">EXT2</td> <td>0 = Communication break monitoring disabled in control location EXT2.</td> </tr> <tr> <td>1 = Communication break monitoring enabled in control location EXT2.</td> </tr> </tbody> </table>				Bit	Name	Information	0	EXT1	0 = Communication break monitoring disabled in control location EXT1.	1 = Communication break monitoring enabled in control location EXT1.	1	EXT2	0 = Communication break monitoring disabled in control location EXT2.	1 = Communication break monitoring enabled in control location EXT2.
Bit	Name	Information												
0	EXT1	0 = Communication break monitoring disabled in control location EXT1.												
		1 = Communication break monitoring enabled in control location EXT1.												
1	EXT2	0 = Communication break monitoring disabled in control location EXT2.												
		1 = Communication break monitoring enabled in control location EXT2.												
		<p><b>Example:</b> <a href="#">50.21</a> bit 0 = 1, bit 1 = 0. That is, the communication break monitoring is enabled in EXT1 and disabled in EXT2.</p> <ul style="list-style-type: none"> <li>If the drive is currently in EXT1, and the communication breaks, the drive takes the action defined in parameter <a href="#">50.02 Comm loss func</a>.</li> <li>If the drive is currently in EXT2, and the communication breaks, the drive does not take any action. If the communication is re-established before switching back to EXT1, the drive continues operating and does not remember the temporary loss of communication.</li> </ul>												

51 FBA settings		Fieldbus adapter-specific settings.	
51.01	FBA type	Displays the type of the connected fieldbus adapter module. 0 = Fieldbus module is not found, or it is not properly connected, or parameter <a href="#">50.01 FBA enable</a> is set to <i>Disable</i> , 1 = PROFIBUS DP, 32 = CANopen, 37 = DeviceNet, 128 = Ethernet, 132 = PROFINET IO, 135 = EtherCAT, 136 = Ethernet POWERLINK, 485 = RS-485, 62944 = SERCOS interface.	
51.02	FBA par2	Parameters <a href="#">51.02...51.26</a> are adapter module-specific. For more information, see the User's Manual of the fieldbus adapter module. Note that not all of these parameters are necessarily used.	-
...	...	...	...
51.26	FBA par26	See parameter <a href="#">51.02 FBA par2</a> .	-
51.27	FBA par refresh	Validates any changed adapter module configuration parameter settings. After refreshing, the value reverts automatically to <i>Done</i> . <b>Note:</b> This parameter cannot be changed while the drive is running.	
	Done	Refreshing done.	0
	Refresh	Refreshing.	1

No.	Name/Value	Description	FbEq
51.28	Par table ver	Displays the parameter table revision of the fieldbus adapter module mapping file stored in the memory of the drive. In format xyz, where x = major revision number; y = minor revision number; z = correction number.	
	0x0000 ... 0xFFFF	Parameter table revision.	1 = 1
51.29	Drive type code	Displays the drive type code of the fieldbus adapter module mapping file stored in the memory of the drive.	
	0 ... 65535	Drive type code of fieldbus adapter module mapping file.	1 = 1
51.30	Mapping file ver	Displays the fieldbus adapter module mapping file revision stored in the memory of the drive in decimal format. Example: 0x107 = revision 1.07.	
	0 ... 65535	Mapping file revision.	1 = 1
51.31	D2FBA comm sta	Displays the status of the fieldbus adapter module communication.	
	Idle	Adapter is not configured.	0
	Exec.init	Adapter is initializing.	1
	Time out	A timeout has occurred in the communication between the adapter and the drive.	2
	Conf.err	Adapter configuration error: The major or minor revision code of the common program revision in the fieldbus adapter module is not the revision required by the module (see parameter <a href="#">51.32 FBA comm sw ver</a> ) or mapping file upload has failed more than three times.	3
	Off-line	Adapter is off-line.	4
	On-line	Adapter is on-line.	5
	Reset	Adapter is performing a hardware reset.	6
51.32	FBA comm sw ver	Displays the common program revision of the adapter module in format axyz, where a = major revision number, xy = minor revision numbers. z = correction letter. Example: 190A = revision 1.90A.	
	0x0000 ... 0xFFFF	Common program version of adapter module.	1 = 1
51.33	FBA appl sw ver	Displays the application program revision of the adapter module in format axyz, where: a = major revision number, xy = minor revision numbers, z = correction letter. Example: 190A = revision 1.90A.	
	0x0000 ... 0xFFFF	Application program revision of adapter module.	1 = 1
<b>52 FBA data in</b>		Selection of data to be transferred from drive to fieldbus controller via fieldbus adapter.	
52.01	FBA data in1	Parameters <a href="#">52.01...52.12</a> select data to be transferred from the drive to the fieldbus controller.	
	0	None	0

No.	Name/Value	Description	FbEq
4		Status Word (16 bits)	4
5		Actual value 1 (16 bits)	5
6		Actual value 2 (16 bits)	6
14		Status Word (32 bits)	14
15		Actual value 1 (32 bits)	15
16		Actual value 2 (32 bits)	16
101...9999		Parameter index	1 = 1
...	...	...	...
52.12	FBA data in12	See parameter <a href="#">52.01 FBA data in1</a> .	

<b>53 FBA data out</b>		Selection of data to be transferred from fieldbus controller to drive via fieldbus adapter.	
53.01	FBA data out1	Parameters <a href="#">53.01</a> ... <a href="#">53.12</a> select data to be transferred from the fieldbus controller to the drive.	
	0	None	0
	1	Control Word (16 bits)	1
	2	Reference REF1 (16 bits)	2
	3	Reference REF2 (16 bits)	3
	11	Control Word (32 bits)	11
	12	Reference REF1 (32 bits)	12
	13	Reference REF2 (32 bits)	13
	101...9999	Parameter index <b>Example:</b> To use the received data as process setpoint, set the value to 240 (ie, parameter <a href="#">02.40 FBA setpoint</a> ). Then, define P.02.40 as the source in parameter <a href="#">29.02</a> (or <a href="#">29.03</a> ) using the pointer setting.	1 = 1
...	...	...	...
53.12	FBA data out12	See parameter <a href="#">53.01 FBA data out1</a> .	

<b>56 Panel display</b>		Selection of signals to be displayed on control panel.	
56.01	Signal1 param	Selects the first signal to be displayed on the optional control panel. The default signal is <a href="#">01.40 Speed filt</a> .	
	Pointer	Value pointer setting (see <a href="#">Terms and abbreviations</a> on page <a href="#">115</a> ).	-
56.02	Signal2 param	Selects the second signal to be displayed on the optional control panel. The default signal is <a href="#">01.04 Motor current</a> .	
	Pointer	Value pointer setting (see <a href="#">Terms and abbreviations</a> on page <a href="#">115</a> ).	-
56.03	Signal3 param	Selects the third signal to be displayed on the optional control panel. The default signal is <a href="#">01.41 Torque filt</a> .	
	Pointer	Value pointer setting (see <a href="#">Terms and abbreviations</a> on page <a href="#">115</a> ).	-
56.04	Signal1 mode	Defines the way the signal selected by parameter <a href="#">56.01 Signal1 param</a> is displayed on the optional control panel.	
	Disabled	Signal not displayed. Any other signals that are not disabled are shown together with their respective signal name.	-1
	Normal	Shows the signal as a numerical value followed by unit.	0

No.	Name/Value	Description	FbEq
	Bar	Shows the signal as a horizontal bar.	1
	Drive name	Shows the drive name. (The drive name can be set using the DriveStudio PC tool.)	2
	Drive type	Shows the drive type.	3
56.05	Signal2 mode	Defines the way the signal selected by parameter <a href="#">56.02 Signal2 param</a> is displayed on the optional control panel.	
	Disabled	Signal not displayed. Any other signals that are not disabled are shown together with their respective signal name.	-1
	Normal	Shows the signal as a numerical value followed by unit.	0
	Bar	Shows the signal as a horizontal bar.	1
	Drive name	Shows the drive name. (The drive name can be set using the DriveStudio PC tool.)	2
	Drive type	Shows the drive type.	3
56.06	Signal3 mode	Defines the way the signal selected by parameter <a href="#">56.03 Signal3 param</a> is displayed on the optional control panel.	
	Disabled	Signal not displayed. Any other signals that are not disabled are shown together with their respective signal name.	-1
	Normal	Shows the signal as a numerical value followed by unit.	0
	Bar	Shows the signal as a horizontal bar.	1
	Drive name	Shows the drive name. (The drive name can be set using the DriveStudio PC tool.)	2
	Drive type	Shows the drive type.	3
56.07	Local ref unit	Defines how speed reference is entered and displayed by the control panel and DriveStudio PC tool. Also determines the unit of signal <a href="#">02.34 Panel ref</a> . <b>Note:</b> This parameter also applies to external control when speed reference is given from the control panel.	
	rpm	Speed reference is displayed and entered in rpm.	0
	Percent	Speed reference is displayed and entered in percent. The scaling is as follows:  <div style="text-align: center;"> <p><b>Control panel reference</b>      <b>Speed (rpm)</b></p> <p>100% — <a href="#">20.01 Maximum speed</a></p> <p>0% — 0</p> <p>-100% — <a href="#">20.02 Minimum speed</a></p> </div>	1
56.08	Speed filt time	Defines a filter time constant for <a href="#">01.40 Speed filt</a> . A longer time constant makes the filtered result more steady, but slows down the reaction to fast speed changes. Compare to parameter <a href="#">19.03 MotorSpeed filt</a> .	
	0.0...10000.0 ms	Speed filter time constant.	10 = 1 ms



No.	Name/Value	Description	FbEq
56.09	Torque filt time	Defines a filter time constant for <a href="#">01.40 Torque filt</a> . A longer time constant makes the filtered result more steady, but slows down the reaction to fast speed changes.	
	0.0...10000.0 ms	Torque filter time constant.	10 = 1 ms
<b>58 Embedded Modbus</b>			
		Configuration parameters for the embedded fieldbus (EFB) interface. See also chapter <a href="#">Control through the embedded fieldbus interface</a> on page 355.	
58.01	Protocol ena sel	Enables/disables the embedded fieldbus communication protocol. <b>Note:</b> When the embedded fieldbus interface is enabled, the drive-to-drive link operation (parameter group 76) is automatically disabled.	
	Disabled	Disabled.	0
	Modbus RTU	Modbus RTU protocol enabled.	1
58.03	Node address	Defines the node address.	
	0...247	Node address.	1 = 1
58.04	Baud rate	Selects the baud rate of the RS-485 link.	
	4800	4.8 kbit/s.	0
	9600	9.6 kbit/s.	1
	19200	19.2 kbit/s.	2
	38400	38.4 kbit/s.	3
	57600	57.6 kbit/s.	4
	76800	76.8 kbit/s.	5
	115200	115.2 kbit/s.	6
58.05	Parity	Selects the number of the data bits, the use and type of the parity bit, and the number of the stop bits.	
	8 none 1	Eight data bits, no parity bit, one stop bit.	0
	8 none 2	Eight data bits, no parity bit, two stop bits.	1
	8 even 1	Eight data bits, even parity bit, one stop bit.	2
	8 odd 1	Eight data bits, odd parity bit, one stop bit.	3
58.06	Control profile	Selects the communication profile used by the Modbus protocol.	
	ABB Classic	ABB Drives profile, classic version.	0
	ABB Enhanced	ABB Drives profile, enhanced version.	1
	DCU 16-bit	DCU 16-bit profile.	2
	DCU 32-bit	DCU 32-bit profile.	3
58.07	Comm loss t out	Defines the timeout limit for EFB communication loss monitoring. If a communication break exceeds the timeout limit, the function proceeds with the action defined with parameter <a href="#">58.09 Comm loss action</a> . See also parameter <a href="#">58.08 Comm loss mode</a> .	
	0...60000 ms	Timeout calculation factor. The actual timeout value is calculated as follows: Comm loss timeout × 100 ms <b>Example:</b> If you set this value to 22, the actual timeout value will be: 22 × 100 ms = 2 200 ms.	100 = 1 ms

## 250 Parameters

No.	Name/Value	Description	FbEq
58.08	Comm loss mode	Enables/disables EFB communication loss monitoring and defines which of the Modbus register accesses resets the timeout counter. See parameter <a href="#">58.07 Comm loss t out</a> .	
	None	EFB communication loss monitoring is disabled.	0
	Any message	EFB communication loss monitoring is enabled. Any Modbus request resets the timeout counter.	1
	Ctrl write	EFB communication loss monitoring is enabled. Writing to control or reference word resets the timeout counter.	2
58.09	Comm loss action	Defines the drive operation after the EFB communication loss monitoring awakes. See parameters <a href="#">58.07 Comm loss t out</a> and <a href="#">58.08 Comm loss mode</a> .	
	None	No action.	0
	Fault	Drive trips on fault <a href="#">EFB COMM (0x7540)</a> .	1
	Safe speed	Drive generates alarm <a href="#">EFB COMM LOSS (0x7540)</a> and takes the safe speed into use (see parameter <a href="#">30.02 Speed ref safe</a> ).	2
	Last speed	Drive generates alarm <a href="#">EFB COMM LOSS (0x7540)</a> and takes the last speed into use (average over the previous 10 seconds).	3
58.10	Refresh settings	Refreshes the settings of parameters <a href="#">58.01...58.09</a> and <a href="#">58.12</a> .	
	Done	Initial value. The value is restored after the refresh is done.	0
	Refresh	Refresh.	1
58.11	Reference scale	Defines the factor which the DCU 16-bit communication profile uses when scaling fieldbus references to drive references and drive actual values to fieldbus actual signals. The references are multiplied by this scaling factor. See section <a href="#">DCU 16-bit profile</a> on page <a href="#">374</a> .	
	1...65535	Scaling factor.	1 = 1
58.12	EFB comm speed	Defines the communication speed (cycle time) for the embedded fieldbus interface. Raising the speed increases the CPU load. Any change in the setting must be validated by parameter <a href="#">58.10 Refresh settings</a> .	
	Low	The communication cycle time is 10 ms.	0
	High	The communication cycle time is 2 ms.	1

No.	Name/Value	Description	FbEq																														
58.15	Comm diagnostics	16-bit packed boolean data word for the communication diagnostics flag bits. Read-only.																															
		<table border="1"> <thead> <tr> <th>Bit</th> <th>Information</th> </tr> </thead> <tbody> <tr> <td>0</td> <td>Reserved.</td> </tr> <tr> <td>1</td> <td>Last received packet was not for this node.</td> </tr> <tr> <td>2</td> <td>Reserved.</td> </tr> <tr> <td>3</td> <td>At least one packet has been successfully received after the power up.</td> </tr> <tr> <td>4</td> <td>Reserved.</td> </tr> <tr> <td>5</td> <td>Communication time-out has occurred.</td> </tr> <tr> <td>6...7</td> <td>Reserved.</td> </tr> <tr> <td>8</td> <td>Last write was not successful because of a parameter value limit violation.</td> </tr> <tr> <td>9</td> <td>Last read was not successful because only one register was used to read a 32-bit value.</td> </tr> <tr> <td>10</td> <td>Last write was not successful because the parameter was read only.</td> </tr> <tr> <td>11</td> <td>Last parameter access was not successful because the parameter or group did not exist.</td> </tr> <tr> <td>12...14</td> <td>Reserved.</td> </tr> <tr> <td>15</td> <td>Last write was not successful because only one register was used to read a 32-bit value.</td> </tr> <tr> <td>16...31</td> <td>Reserved.</td> </tr> </tbody> </table>	Bit	Information	0	Reserved.	1	Last received packet was not for this node.	2	Reserved.	3	At least one packet has been successfully received after the power up.	4	Reserved.	5	Communication time-out has occurred.	6...7	Reserved.	8	Last write was not successful because of a parameter value limit violation.	9	Last read was not successful because only one register was used to read a 32-bit value.	10	Last write was not successful because the parameter was read only.	11	Last parameter access was not successful because the parameter or group did not exist.	12...14	Reserved.	15	Last write was not successful because only one register was used to read a 32-bit value.	16...31	Reserved.	
Bit	Information																																
0	Reserved.																																
1	Last received packet was not for this node.																																
2	Reserved.																																
3	At least one packet has been successfully received after the power up.																																
4	Reserved.																																
5	Communication time-out has occurred.																																
6...7	Reserved.																																
8	Last write was not successful because of a parameter value limit violation.																																
9	Last read was not successful because only one register was used to read a 32-bit value.																																
10	Last write was not successful because the parameter was read only.																																
11	Last parameter access was not successful because the parameter or group did not exist.																																
12...14	Reserved.																																
15	Last write was not successful because only one register was used to read a 32-bit value.																																
16...31	Reserved.																																
	0x0000...0xFFFF	Data word (hex).	1 = 1																														
58.16	Received packets	Shows the number of message packets received by the drive, including only such packets that are addressed to the drive. <b>Note:</b> The user can reset the counter (by setting the value to 0).																															
	0...65535	No. of message packets.	1 = 1																														
58.17	Transm packets	Shows the number of message packets sent by the drive. <b>Note:</b> The user can reset the counter (by setting the value to 0).																															
	0...65535	No. of message packets.	1 = 1																														
58.18	All packets	Shows the total number of message packets received by the drive, including all packets addressed to any valid node on the fieldbus link. <b>Note:</b> The user can reset the counter (by setting the value to 0).																															
	0...65535	No. of message packets.	1 = 1																														
58.19	UART errors	Shows the number of messages with communication errors other than CRC errors which the drive has received (e.g. UART buffer overflow errors). Read-only.																															
	0..65535	No. of messages with errors (excluding messages with CRC errors).	1 = 1																														
58.20	CRC errors	Shows the number of messages with Cyclic Redundancy Check (CRC) errors which the drive has received. Read only. <b>Note:</b> High electromagnetic noise levels may generate errors.																															
	0...65535	No. of messages with CRC errors.	1 = 1																														
58.21	Raw CW LSW	Shows the LSW part of the Control Word which the drive receives from the Modbus master. Read-only.																															
	0x0000...0xFFFF	Bits 0... 15 of the Control word as a hex value.	1 = 1																														

## 252 Parameters

No.	Name/Value	Description	FbEq
58.22	Raw CW MSW	Shows the MSW part of the Control Word which the drive receives from the Modbus master. Read-only.	
	0x0000...0xFFFF	Bits 16...32 of the Control word as a hex value.	1 = 1
58.23	Raw SW LSW	Shows the LSW part of the Status Word which the drive sends to the Modbus master. Read-only.	
	0x0000...0xFFFF	Bits 0...15 of the Status word as a hex value.	1 = 1
58.24	Raw SW MSW	Shows the MSW part of the Status Word which the drive sends to the Modbus master. Read-only.	
	0x0000...0xFFFF	Bits 16...32 of the Status word as a hex value.	1 = 1
58.25	Raw Ref 1 LSW	Shows the LSW part of reference 1 which the drive receives from the Modbus master. Read-only.	
	0x0000...0xFFFF	Bits 0...15 of reference 1 as a hex value.	1 = 1
58.26	Raw Ref 1 MSW	Shows the MSW part of reference 1 which the drive receives from the Modbus master. Read-only.	
	0x0000...0xFFFF	Bits 16...32 of reference 1 as a hex value.	1 = 1
58.27	Raw Ref 2 LSW	Shows the LSW part of reference 2 which the drive receives from the Modbus master. Read-only.	
	0x0000...0xFFFF	Bits 0...15 of reference 2 as a hex value.	1 = 1
58.28	Raw Ref 2 MSW	Shows the MSW part of reference 2 which the drive receives from the Modbus master. Read-only.	
	0x0000...0xFFFF	Bits 16...32 of reference 2 as a hex value.	1 = 1
58.30	Transmit delay	Defines the delay time which the slave waits until it sends a response.	
	0...65335 ms	Transmit delay time.	1 = 1 ms
58.31	Ret app errors	Selects whether the drive returns Modbus exception codes or not.	
	No	No	0
	Yes	Yes	1
58.32	Word order	Defines the order of the data words in the Modbus frame.	
	MSW LSW	Most significant word first, then Least significant word.	0
	LSW MSW	Least significant word first, then Most significant word.	1
58.35	Data I/O 1	Defines the address of the drive parameter which the Modbus master accesses when it reads from or writes to the register address corresponding to Modbus In/Out parameter no. 1. The Modbus master defines the type of the data (input or output). The value is conveyed in a Modbus frame using two 16-bit words. If the drive parameter is a 16-bit value, the LSW (Least significant word) conveys the value. If the drive parameter is a 32-bit value, the next Modbus In/Out parameter is also reserved.	
	0...9999	Parameter address. Format: xxyy, where: xx = parameter group yy = parameter index	1 = 1
58.36	Data I/O 2	See parameter <a href="#">58.35</a> .	
	0...9999	See parameter <a href="#">58.35</a> .	1 = 1
...	...	...	...

No.	Name/Value	Description	FbEq
58.58	Data I/O 24	See parameter <a href="#">58.35</a> .	
	0...9999	See parameter <a href="#">58.35</a> .	1 = 1
<b>64 Load analyzer</b>		Peak value and amplitude logger settings. See also section <a href="#">Load analyzer</a> on page <a href="#">88</a> .	
64.01	PVL signal	Selects the signal to be monitored by the peak value logger. The signal is filtered using the filtering time specified by parameter <a href="#">64.02 PVL filt time</a> . The peak value is stored, along with other pre-selected signals at the time, into parameters <a href="#">64.06...64.11</a> . Parameter <a href="#">64.03 Reset loggers</a> resets both the peak value logger and amplitude logger 2. The latest time the loggers were reset is stored into parameter <a href="#">64.13</a> .	
	Speed rpm	<a href="#">01.01 Motor speed rpm</a> (see page <a href="#">118</a> ).	1073742081
	Speed %	<a href="#">01.02 Motor speed %</a> (see page <a href="#">118</a> ).	1073742082
	Frequency	<a href="#">01.03 Output frequency</a> (see page <a href="#">118</a> ).	1073742083
	Current	<a href="#">01.04 Motor current</a> (see page <a href="#">118</a> ).	1073742084
	Current %	<a href="#">01.05 Motor current %</a> (see page <a href="#">118</a> ).	1073742085
	Torque	<a href="#">01.06 Motor torque</a> (see page <a href="#">118</a> ).	1073742086
	Dc-voltage	<a href="#">01.07 Dc-voltage</a> (see page <a href="#">118</a> ).	1073742087
	Power inu	<a href="#">01.22 Power inu out</a> (see page <a href="#">118</a> ).	1073742102
	Power motor	<a href="#">01.23 Motor power</a> (see page <a href="#">118</a> ).	1073742103
	Process act	<a href="#">04.01 Act val</a> (see page <a href="#">129</a> ).	1073742849
	Proc PID out	<a href="#">04.05 Process PID out</a> (see page <a href="#">129</a> ).	1073742853
	Pointer	Value pointer setting (see <a href="#">Terms and abbreviations</a> on page <a href="#">115</a> ).	-
64.02	PVL filt time	Peak value logger filtering time. See parameter <a href="#">64.01 PVL signal</a> .	
	0.00 ... 120.00 s	Peak value logger filtering time.	100 = 1 s
64.03	Reset loggers	Selects the signal to reset the peak value logger and amplitude logger 2. (Amplitude logger 1 cannot be reset.)	
	Const	Bit pointer setting (see <a href="#">Terms and abbreviations</a> on page <a href="#">115</a> ).	-
	Pointer		
64.04	AL signal	Selects the signal to be monitored by amplitude logger 2. The signal is sampled at 200 ms intervals when the drive is running. The results are displayed by parameters <a href="#">64.24...64.33</a> . Each parameter represents an amplitude range, and shows what portion of the samples fall within that range. The signal value corresponding to 100% is defined by parameter <a href="#">64.05 AL signal base</a> . Parameter <a href="#">64.03 Reset loggers</a> resets both the peak value logger and amplitude logger 2. The latest time the loggers were reset is stored into parameter <a href="#">64.13</a> . <b>Note:</b> Amplitude logger 1 is fixed to monitor motor current ( <a href="#">01.04 Motor current</a> ). The results are displayed by parameters <a href="#">64.14...64.23</a> . 100% of the signal value corresponds to the maximum output current of the drive (see the appropriate <i>Hardware Manual</i> ).	
	Speed rpm	<a href="#">01.01 Motor speed rpm</a> (see page <a href="#">118</a> ).	1073742081

## 254 Parameters

No.	Name/Value	Description	FbEq
	Speed %	<a href="#">01.02 Motor speed %</a> (see page <a href="#">118</a> ).	1073742082
	Frequency	<a href="#">01.03 Output frequency</a> (see page <a href="#">118</a> ).	1073742083
	Current	<a href="#">01.04 Motor current</a> (see page <a href="#">118</a> ).	1073742084
	Current %	<a href="#">01.05 Motor current %</a> (see page <a href="#">118</a> ).	1073742085
	Torque	<a href="#">01.06 Motor torque</a> (see page <a href="#">118</a> ).	1073742086
	Dc-voltage	<a href="#">01.07 Dc-voltage</a> (see page <a href="#">118</a> ).	1073742087
	Power inu	<a href="#">01.22 Power inu out</a> (see page <a href="#">118</a> ).	1073742102
	Power motor	<a href="#">01.23 Motor power</a> (see page <a href="#">118</a> ).	1073742103
	Process act	<a href="#">04.01 Act val</a> (see page <a href="#">129</a> ).	1073742849
	Proc PID out	<a href="#">04.05 Process PID out</a> (see page <a href="#">129</a> ).	1073742853
	Pointer	Value pointer setting (see <a href="#">Terms and abbreviations</a> on page <a href="#">115</a> ).	-
64.05	AL signal base	Defines the signal value that corresponds to 100% amplitude.	
	0.00 ... 32768.00	Signal value corresponding to 100%.	100 = 1
64.06	PVL peak value1	Peak value recorded by the peak value logger.	
	-32768.00 ... 32768.00	Peak value.	100 = 1
64.07	Date of peak	The date on which the peak value was recorded.	
	01.01.80 ...	Peak occurrence date (dd.mm.yy).	1 = 1 d
64.08	Time of peak	The time at which the peak value was recorded.	
	00:00:00 ... 23:59:59	Peak occurrence time.	1 = 1 s
64.09	Current at peak	Motor current at the moment the peak value was recorded.	
	-32768.00 ... 32768.00 A	Motor current at peak.	100 = 1 A
64.10	Dc volt at peak	Voltage in the intermediate DC circuit of the drive at the moment the peak value was recorded.	
	0.00 ... 2000.00 V	DC voltage at peak.	100 = 1 V
64.11	Speed at peak	Motor speed at the moment the peak value was recorded.	
	-32768.00 ... 32768.00 rpm	Motor speed at peak.	100 = 1 rpm
64.12	Date of reset	The date the peak value logger and amplitude logger 2 were last reset.	
	01.01.80 ...	Last reset date of loggers (dd.mm.yy).	1 = 1 d
64.13	Time of reset	The time the peak value logger and amplitude logger 2 were last reset.	
	00:00:00 ... 23:59:59	Last reset time of loggers.	1 = 1 s
64.14	AL1 0 to 10%	Percentage of samples recorded by amplitude logger 1 that fall between 0 and 10%.	
	0.00 ... 100.00%	Amplitude logger 1 samples between 0 and 10%.	100 = 1%
64.15	AL1 10 to 20%	Percentage of samples recorded by amplitude logger 1 that fall between 10 and 20%.	
	0.00 ... 100.00%	Amplitude logger 1 samples between 10 and 20%.	100 = 1%

No.	Name/Value	Description	FbEq
64.16	AL1 20 to 30%	Percentage of samples recorded by amplitude logger 1 that fall between 20 and 30%.	
	0.00 ... 100.00%	Amplitude logger 1 samples between 20 and 30%.	100 = 1%
64.17	AL1 30 to 40%	Percentage of samples recorded by amplitude logger 1 that fall between 30 and 40%.	
	0.00 ... 100.00%	Amplitude logger 1 samples between 30 and 40%.	100 = 1%
64.18	AL1 40 to 50%	Percentage of samples recorded by amplitude logger 1 that fall between 40 and 50%.	
	0.00 ... 100.00%	Amplitude logger 1 samples between 40 and 50%.	100 = 1%
64.19	AL1 50 to 60%	Percentage of samples recorded by amplitude logger 1 that fall between 50 and 60%.	
	0.00 ... 100.00%	Amplitude logger 1 samples between 50 and 60%.	100 = 1%
64.20	AL1 60 to 70%	Percentage of samples recorded by amplitude logger 1 that fall between 60 and 70%.	
	0.00 ... 100.00%	Amplitude logger 1 samples between 60 and 70%.	100 = 1%
64.21	AL1 70 to 80%	Percentage of samples recorded by amplitude logger 1 that fall between 70 and 80%.	
	0.00 ... 100.00%	Amplitude logger 1 samples between 70 and 80%.	100 = 1%
64.22	AL1 80 to 90%	Percentage of samples recorded by amplitude logger 1 that fall between 80 and 90%.	
	0.00 ... 100.00%	Amplitude logger 1 samples between 80 and 90%.	100 = 1%
64.23	AL1 over 90%	Percentage of samples recorded by amplitude logger 1 that exceed 90%.	
	0.00 ... 100.00%	Amplitude logger 1 samples over 90%.	100 = 1%
64.24	AL2 0 to 10%	Percentage of samples recorded by amplitude logger 2 that fall between 0 and 10%.	
	0.00 ... 100.00%	Amplitude logger 2 samples between 0 and 10%.	100 = 1%
64.25	AL2 10 to 20%	Percentage of samples recorded by amplitude logger 2 that fall between 10 and 20%.	
	0.00 ... 100.00%	Amplitude logger 2 samples between 10 and 20%.	100 = 1%
64.26	AL2 20 to 30%	Percentage of samples recorded by amplitude logger 2 that fall between 20 and 30%.	
	0.00 ... 100.00%	Amplitude logger 2 samples between 20 and 30%.	100 = 1%
64.27	AL2 30 to 40%	Percentage of samples recorded by amplitude logger 2 that fall between 30 and 40%.	
	0.00 ... 100.00%	Amplitude logger 2 samples between 30 and 40%.	100 = 1%
64.28	AL2 40 to 50%	Percentage of samples recorded by amplitude logger 2 that fall between 40 and 50%.	
	0.00 ... 100.00%	Amplitude logger 2 samples between 40 and 50%.	100 = 1%
64.29	AL2 50 to 60%	Percentage of samples recorded by amplitude logger 2 that fall between 50 and 60%.	
	0.00 ... 100.00%	Amplitude logger 2 samples between 50 and 60%.	100 = 1%
64.30	AL2 60 to 70%	Percentage of samples recorded by amplitude logger 2 that fall between 60 and 70%.	
	0.00 ... 100.00%	Amplitude logger 2 samples between 60 and 70%.	100 = 1%

No.	Name/Value	Description	FbEq
64.31	AL2 70 to 80%	Percentage of samples recorded by amplitude logger 2 that fall between 70 and 80%.	
	0.00 ... 100.00%	Amplitude logger 2 samples between 70 and 80%.	100 = 1%
64.32	AL2 80 to 90%	Percentage of samples recorded by amplitude logger 2 that fall between 80 and 90%.	
	0.00 ... 100.00%	Amplitude logger 2 samples between 80 and 90%.	100 = 1%
64.33	AL2 over 90%	Percentage of samples recorded by amplitude logger 2 that exceed 90%.	
	0.00 ... 100.00%	Amplitude logger 2 samples over 90%.	100 = 1%

<b>75 Pump logic</b>		Configuration settings for the pump station.	
75.01	Operation mode	Selects the pump control mode.	
	Off	Use this setting for a single pump and for level control applications, even if the application has several pumps.	0
	Trad ctrl	Traditional pump control mode. One pump at a time is controlled by the drive. The remaining pumps are direct-on-line pumps that are started and stopped by the drive logic.	1
	Reg bypass	PID controller bypass mode. The signal selected by parameters 28.01...28.04 is used as the reference. The automatic starting and stopping of direct-on-line pumps is related to this actual value instead of the output of the PID controller. This setting can be used in applications with a low number of sensors and low accuracy requirements. <i>Example:</i> The capacity of the pumping station (outlet flow) follows the measured inlet flow.	2

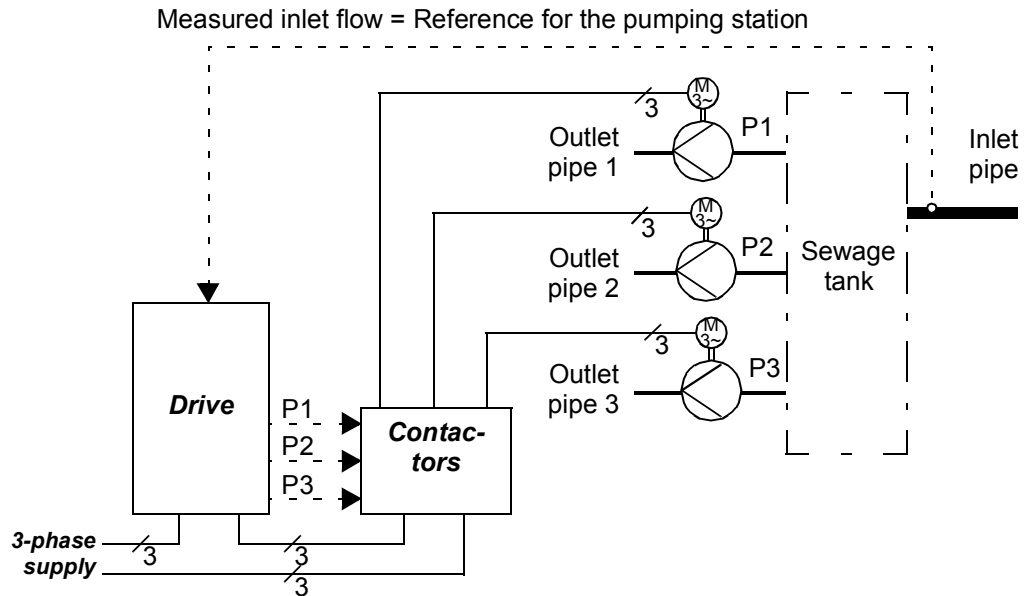



No.	Name/Value	Description	FbEq
		<p>In the diagram below, the slopes of the lines describe the relation between the control signal (selected by parameters <a href="#">28.01...28.04</a>) and the speed of the controlled pump in a three-motor system. At full control signal level, all pumps are operating at maximum speed.</p>	
	Multipump	Multiple drives, each controlling a separate pump, are connected together using the drive-to-drive link.	3
75.02	Nbr of pumps	Total number of pumps used in the application, including the pump connected directly to the drive.	
0...8		Number of pumps.	1 = 1

No.	Name/Value	Description	FbEq
75.03	Follower mode	Selects the source of reference when the drive is a follower.	
	Const speed	<p>Follower drives are started and stopped by the control logic in the master drive. The master receives its reference from the PI controller.</p> <p>When flow demand increases, new pumps are started.</p> <p>If parameter <a href="#">76.10 Master location</a> is set to <i>In start</i>, the latest drive to start becomes the master; at the same time, the previously-started drive becomes a follower and starts to follow the reference defined by parameter <a href="#">75.04 Follower ref</a>.</p> <p>If parameter <a href="#">76.10 Master location</a> is set to <i>Stable</i>, the drive that was started first remains the master.</p>	0

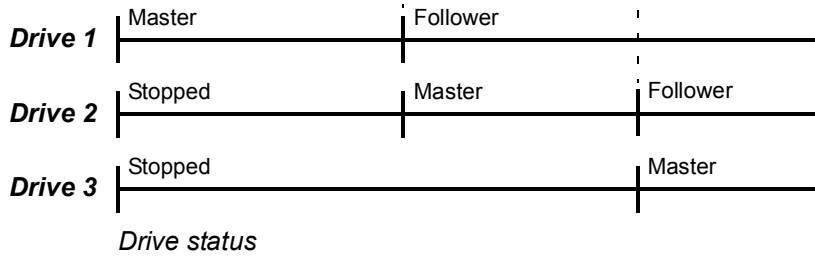
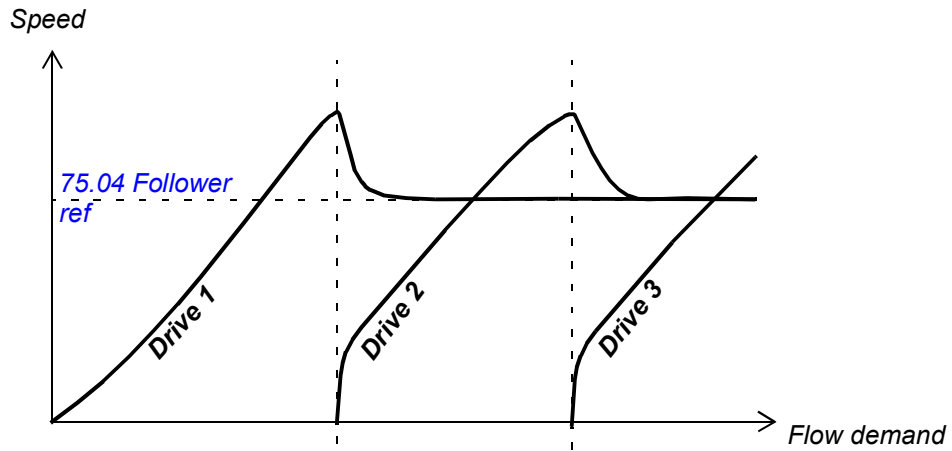

See also the diagrams at parameter [75.04 Follower ref](#).

No.	Name/Value	Description	FbEq
	Copy of mstr	<p>The drive follows the same start/stop commands and reference (received from the PI controller) as the master. With this setting, the drive does not become master when started.</p> <p>In the example shown, drive 1 is master; drives 2 and 3 have parameter <a href="#">75.03 Follower mode</a> set to <a href="#">Copy of mstr</a>.</p>	1

**Drive 1** | Master

---

**Drive 2** | Follower

---

**Drive 3** | Follower

---

Drive status

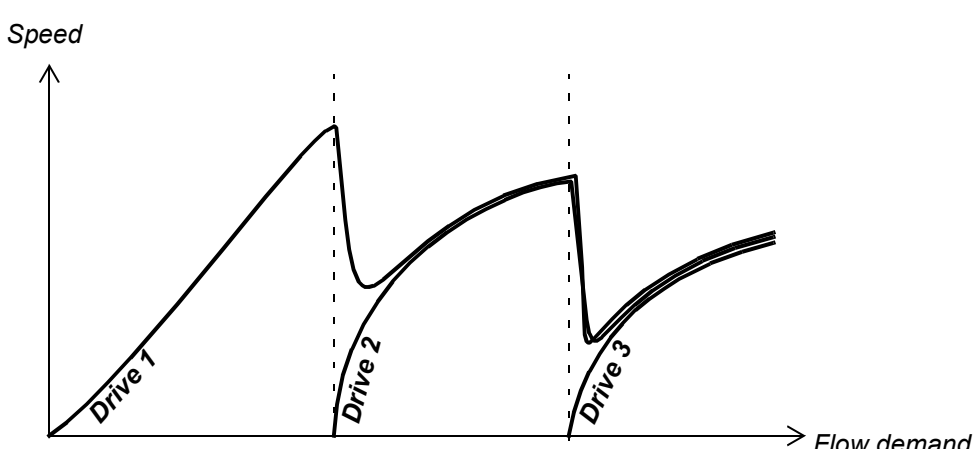
No.	Name/Value	Description	FbEq												
	Master speed	<p>The drive follows the same reference (received from the PI controller) as the master, but is started and stopped by the logic. This is usually the most economical follower mode.</p>  <p><i>Speed</i></p> <p><i>Flow demand</i></p> <p><i>Drive 1</i></p> <p><i>Drive 2</i></p> <p><i>Drive 3</i></p> <p><i>Drive status</i></p> <table border="1" data-bbox="266 896 1113 1142"> <tr> <td><b>Drive 1</b></td> <td>Master</td> <td>Follower</td> <td></td> </tr> <tr> <td><b>Drive 2</b></td> <td>Stopped</td> <td>Master</td> <td>Follower</td> </tr> <tr> <td><b>Drive 3</b></td> <td>Stopped</td> <td></td> <td>Master</td> </tr> </table> <p>In case the master status switches from one drive to another and the reference changes drastically, the drive compares the most recent reference value with the previous reference. If the difference between the references is more than 10%, the follower will accelerate/decelerate towards the new reference along a ramp. The acceleration and deceleration ramps are defined by parameters <a href="#">75.26 Master speed acc</a> and <a href="#">75.27 Master speed dec</a> respectively. The ramping will end when the new reference is reached.</p>	<b>Drive 1</b>	Master	Follower		<b>Drive 2</b>	Stopped	Master	Follower	<b>Drive 3</b>	Stopped		Master	2
<b>Drive 1</b>	Master	Follower													
<b>Drive 2</b>	Stopped	Master	Follower												
<b>Drive 3</b>	Stopped		Master												

No.	Name/Value	Description	FbEq
75.04	Follower ref	<p>Applicable only when <i>Multipump</i> is selected at parameter <a href="#">75.01 Operation mode</a>.</p> <p>Defines the reference used when parameter <a href="#">75.03 Follower mode</a> is set to <i>Const speed</i>, and the drive is running as a follower.</p> <p>The following diagram illustrates the starting of the drives in a typical multipump configuration as the reference (flow demand) first increases, then decreases. Follower start and stop delays (parameters <a href="#">75.19 Start delay</a> and <a href="#">75.20 Stop delay</a>) are ignored in this presentation.</p>	
<p>The diagram consists of four vertically aligned graphs sharing a common time axis. Vertical dashed lines mark key events: the start of the reference rise, the peak of the reference, the start of the reference fall, and the end of the reference.   <b>Reference:</b> A bell-shaped curve representing flow demand.   <b>Drive 1:</b> Starts as Master (M) until the reference begins to rise, then switches to Follower (F). Its speed profile shows a rise to a peak (75.05 Start speed 1), a dip, a steady state at the Follower ref level (75.04 Follower ref), a small bump at the reference fall, and a stop.   <b>Drive 2:</b> Starts as Follower (F) until the reference begins to rise, then switches to Master (M). Its speed profile shows a rise to a peak (75.06 Start speed 2), a dip, a steady state at the Follower ref level (75.04 Follower ref), a bump at the reference fall, and a stop at 75.12 Stop speed 1.   <b>Drive 3:</b> Starts as Follower (F) until the reference begins to rise, then switches to Master (M). Its speed profile shows a rise to a peak (75.13 Stop speed 2) and then a stop.   <b>Status:</b> Below each graph is a timeline of Master (M) and Follower (F) states, with (S) indicating stopped periods.</p>			
0...32767 rpm	Reference setting. This should generally be set at the optimal operating point of the pump.	1 = 1 rpm	

No.	Name/Value	Description	FbEq
75.05	Start speed 1	<p>When parameter <a href="#">75.01</a> is set to <i>Trad ctrl</i> or <i>Reg bypass</i>, this parameter defines the start speed for auxiliary pump 1.</p> <p>When parameter <a href="#">75.01</a> is set to <i>Multipump</i>, this parameter defines the master speed at which the first follower drive starts.</p> <p>When the speed of the pump connected directly to the drive exceeds this value and no auxiliary pumps or followers are running, the start delay counter (see parameter <a href="#">75.19 Start delay</a>) is started. If the speed is still at the same level or higher when the delay elapses, the first auxiliary pump or follower starts.</p> <p>The running speed of the drive is decreased by <a href="#">Start speed 1</a> - <a href="#">Stop speed 1</a> after the auxiliary pump or follower starts.</p>	

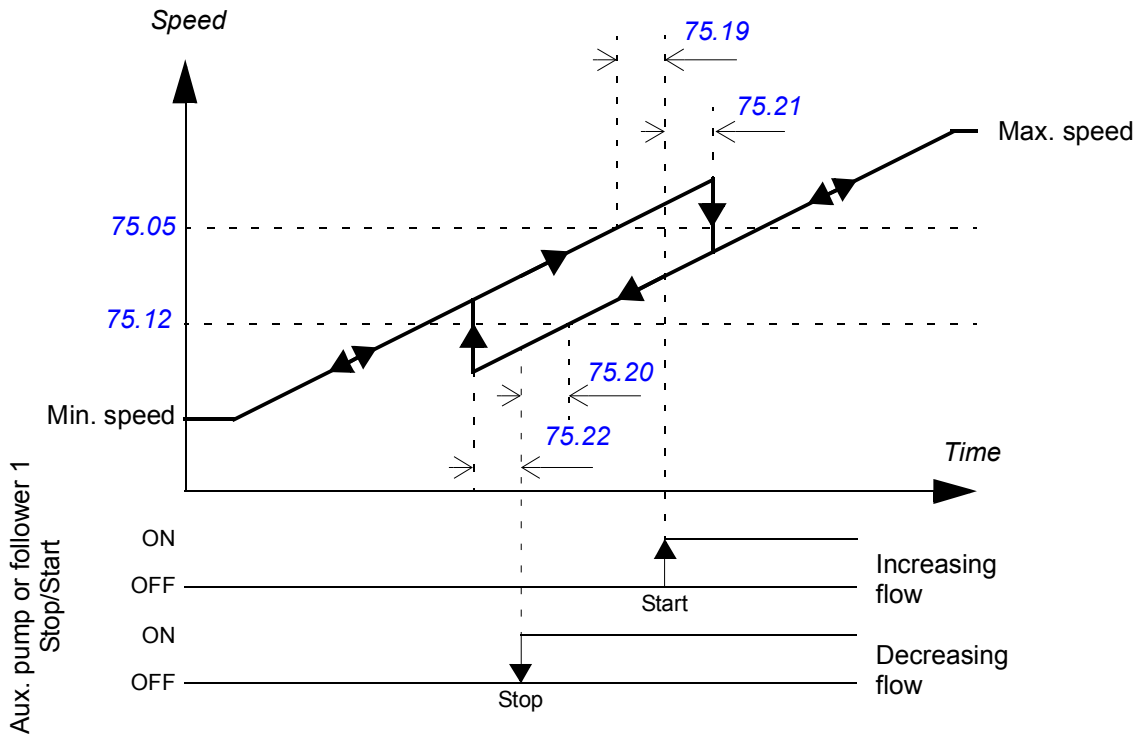

No.	Name/Value	Description	FbEq
		The following diagram shows the order of some common speeds in a pump application.	
		<p style="text-align: center;">Speed</p> <p style="text-align: center;">(Negative speeds only used by the pump cleaning function (<a href="#">82.03</a>))</p>	
	0...32767 rpm	Start speed for auxiliary pump or follower 1.	1 = 1 rpm
75.06	Start speed 2	Defines the start speed for auxiliary pump or follower 2. See parameter <a href="#">75.05 Start speed 1</a> .	
	0...32767 rpm	Start speed for auxiliary pump or follower 2.	1 = 1 rpm
75.07	Start speed 3	Defines the start speed for auxiliary pump or follower 3. See parameter <a href="#">75.05 Start speed 1</a> .	
	0...32767 rpm	Start speed for auxiliary pump or follower 3.	1 = 1 rpm
75.08	Start speed 4	Defines the start speed for auxiliary pump or follower 4. See parameter <a href="#">75.05 Start speed 1</a> .	
	0...32767 rpm	Start speed for auxiliary pump or follower 4.	1 = 1 rpm
75.09	Start speed 5	Defines the start speed for auxiliary pump or follower 5. See parameter <a href="#">75.05 Start speed 1</a> .	
	0...32767 rpm	Start speed for auxiliary pump or follower 5.	1 = 1 rpm
75.10	Start speed 6	Defines the start speed for auxiliary pump or follower 6. See parameter <a href="#">75.05 Start speed 1</a> .	
	0...32767 rpm	Start speed for auxiliary pump or follower 6.	1 = 1 rpm
75.11	Start speed 7	Defines the start speed for auxiliary pump or follower 7. See parameter <a href="#">75.05 Start speed 1</a> .	
	0...32767 rpm	Start speed for auxiliary pump or follower 7.	1 = 1 rpm

## 264 Parameters

No.	Name/Value	Description	FbEq
75.12	Stop speed 1	When parameter <a href="#">75.01</a> is set to <i>Trad ctrl</i> or <i>Reg bypass</i> , this parameter defines the stop speed for auxiliary pump 1. When parameter <a href="#">75.01</a> is set to <i>Multipump</i> , this parameter defines the master speed at which the first follower drive stops. When the speed of the pump connected directly to the drive falls below this value and one auxiliary pump or follower is running, the stop delay counter (see parameter <a href="#">75.20 Stop delay</a> ) is started. If the speed is still at the same level or lower when the delay elapses, the first auxiliary pump or follower stops. The running speed of the drive is increased by <i>Start speed 1</i> - <i>Stop speed 1</i> after the auxiliary pump or follower stops. See also parameter <a href="#">75.05 Start speed 1</a> .	
	0...32767 rpm	Stop speed for auxiliary pump or follower 1.	1 = 1 rpm
75.13	Stop speed 2	Defines the stop speed for auxiliary pump or follower 2. See parameter <a href="#">75.12 Stop speed 1</a> .	
	0...32767 rpm	Stop speed for auxiliary pump or follower 2.	1 = 1 rpm
75.14	Stop speed 3	Defines the stop speed for auxiliary pump or follower 3. See parameter <a href="#">75.12 Stop speed 1</a> .	
	0...32767 rpm	Stop speed for auxiliary pump or follower 3.	1 = 1 rpm
75.15	Stop speed 4	Defines the stop speed for auxiliary pump or follower 4. See parameter <a href="#">75.12 Stop speed 1</a> .	
	0...32767 rpm	Stop speed for auxiliary pump or follower 4.	1 = 1 rpm
75.16	Stop speed 5	Defines the stop speed for auxiliary pump or follower 5. See parameter <a href="#">75.12 Stop speed 1</a> .	
	0...32767 rpm	Stop speed for auxiliary pump or follower 5.	1 = 1 rpm
75.17	Stop speed 6	Defines the stop speed for auxiliary pump or follower 6. See parameter <a href="#">75.12 Stop speed 1</a> .	
	0...32767 rpm	Stop speed for auxiliary pump or follower 6.	1 = 1 rpm
75.18	Stop speed 7	Defines the stop speed for auxiliary pump or follower 7. See parameter <a href="#">75.12 Stop speed 1</a> .	
	0...32767 rpm	Stop speed for auxiliary pump or follower 7.	1 = 1 rpm
75.19	Start delay	Defines a start delay for auxiliary pumps or followers. See parameter <a href="#">75.05 Start speed 1</a> .	
	0...12600 s	Start delay.	1 = 1 s
75.20	Stop delay	Defines a stop delay for auxiliary pumps or followers. See parameter <a href="#">75.05 Start speed 1</a> .	
	0...12600 s	Stop delay.	1 = 1 s
75.21	Speed hold on	See diagram at parameter <a href="#">75.05 Start speed 1</a> .	
	0...100 s	Speed hold time for auxiliary pump switch-on.	1 = 1 s
75.22	Speed hold off	See diagram at parameter <a href="#">75.05 Start speed 1</a> .	
	0...100 s	Speed hold time for auxiliary pump switch-off.	1 = 1 s
75.23	Min pumps allow	Defines the minimum number of pumps that will run simultaneously. <b>Note:</b> The pumps that are kept running will ignore the stop speeds defined for them by other parameters in this group.	
	0...8	Minimum number of pumps.	1 = 1





No.	Name/Value	Description	FbEq
75.31	Quick ramp acc1	<p>Defines the quick ramp set 1 acceleration time as the time required for the speed to change from zero to the speed value defined by parameter <a href="#">19.01 Speed scaling</a> (<b>not</b> to parameter <a href="#">20.01 Maximum speed</a>).</p> <p>If the speed reference increases faster than the set acceleration rate, the motor speed will follow the acceleration rate.</p> <p>If the speed reference increases slower than the set acceleration rate, the motor speed will follow the reference signal.</p> <p>If the acceleration time is set too short, the drive will automatically prolong the acceleration in order not to exceed the drive torque limits.</p>	
	0.000 ... 1800.000 s	Quick ramp set 1 acceleration time.	1000 = 1 s
75.32	Quick ramp dec1	<p>Defines the quick ramp set 1 deceleration time as the time required for the speed to change from the speed value defined by parameter <a href="#">19.01 Speed scaling</a> (<b>not</b> from parameter <a href="#">20.01 Maximum speed</a>) to zero.</p> <p>If the speed reference decreases slower than the set deceleration rate, the motor speed will follow the reference signal.</p> <p>If the reference changes faster than the set deceleration rate, the motor speed will follow the deceleration rate.</p> <p>If the deceleration time is set too short, the drive will automatically prolong the deceleration in order not to exceed drive torque limits. If there is any doubt about the deceleration time being too short, ensure that the DC overvoltage control is on (parameter <a href="#">47.01 Overvolt ctrl</a>).</p>	
	0.000 ... 1800.000 s	Quick ramp set 1 deceleration time.	1000 = 1 s
75.33	QR 1/2 swtch	<p>Selects the source for switching from quick ramp set 1 to quick ramp set 2.</p> <p>1 = Quick ramp set 1 is active.</p> <p>0 = Quick ramp set 2 is active.</p> <p>Parameter <a href="#">75.37 QR/NR swtch</a> overrides this parameter.</p>	
	Not used	No source selected.	1074070017
	DI1	Digital input DI1 (as indicated by <a href="#">02.01 DI status</a> , bit 0).	1073742337
	DI2	Digital input DI2 (as indicated by <a href="#">02.01 DI status</a> , bit 1).	1073807873
	DI3	Digital input DI3 (as indicated by <a href="#">02.01 DI status</a> , bit 2).	1073873409
	DI4	Digital input DI4 (as indicated by <a href="#">02.01 DI status</a> , bit 3).	1073938945
	DI5	Digital input DI5 (as indicated by <a href="#">02.01 DI status</a> , bit 4).	1074004481
	Speed	Speed (as indicated by <a href="#">05.48 Ramp status</a> , bit 6). The ramp set is changed when the actual speed exceeds the switchover speed defined by <a href="#">75.34 QR 1/2 swtch spd</a> .	1074136368
	Const	Bit pointer setting (see <a href="#">Terms and abbreviations</a> on page <a href="#">115</a> ).	-
	Pointer		
75.34	QR 1/2 swtch spd	When <a href="#">75.33 QR 1/2 swtch</a> is set to <i>Speed</i> , this parameter defines the speed at which quick ramp set 1 is changed to quick ramp set 2. The ramp set is changed when the actual speed exceeds this switchover speed.	
	0.0 ... 30000.0 rpm	Switchover speed.	10 = 1 rpm

No.	Name/Value	Description	FbEq
75.35	Quick ramp acc2	<p>Defines the quick ramp set 2 acceleration time as the time required for the speed to change from zero to the speed value defined by parameter <a href="#">19.01 Speed scaling</a> (not to parameter <a href="#">20.01 Maximum speed</a>).</p> <p>If the speed reference increases faster than the set acceleration rate, the motor speed will follow the acceleration rate.</p> <p>If the speed reference increases slower than the set acceleration rate, the motor speed will follow the reference signal.</p> <p>If the acceleration time is set too short, the drive will automatically prolong the acceleration in order not to exceed the drive torque limits.</p>	
	0.000 ... 1800.000 s	Quick ramp set 2 acceleration time.	1000 = 1 s
75.36	Quick ramp dec2	<p>Defines the quick ramp set 2 deceleration time as the time required for the speed to change from the speed value defined by parameter <a href="#">19.01 Speed scaling</a> (not from parameter <a href="#">20.01 Maximum speed</a>) to zero.</p> <p>If the speed reference decreases slower than the set deceleration rate, the motor speed will follow the reference signal.</p> <p>If the reference changes faster than the set deceleration rate, the motor speed will follow the deceleration rate.</p> <p>If the deceleration time is set too short, the drive will automatically prolong the deceleration in order not to exceed drive torque limits. If there is any doubt about the deceleration time being too short, ensure that the DC overvoltage control is on (parameter <a href="#">47.01 Overvolt ctrl</a>).</p>	
	0.000 ... 1800.000 s	Quick ramp set 2 deceleration time.	1000 = 1 s
75.37	QR/NR swtch	<p>Selects the source for switching from quick ramp set 1 or set 2 to the standard ramp set defined by parameters <a href="#">22.02 Acc time</a> and <a href="#">22.03 Dec time</a>.</p> <p>1 = Standard ramp set is active. 0 = Quick ramp set 1 or set 2 is active.</p> <p>This parameter overrides parameter <a href="#">75.33 QR 1/2 swtch</a>.</p>	
	Not used	No source selected.	1074070017
	DI1	Digital input DI1 (as indicated by <a href="#">02.01 DI status</a> , bit 0).	1073742337
	DI2	Digital input DI2 (as indicated by <a href="#">02.01 DI status</a> , bit 1).	1073807873
	DI3	Digital input DI3 (as indicated by <a href="#">02.01 DI status</a> , bit 2).	1073873409
	DI4	Digital input DI4 (as indicated by <a href="#">02.01 DI status</a> , bit 3).	1073938945
	DI5	Digital input DI5 (as indicated by <a href="#">02.01 DI status</a> , bit 4).	1074004481
	Speed	Speed (as indicated by <a href="#">05.48 Ramp status</a> , bit 7). The ramp set is changed when the actual speed exceeds the switchover speed defined by <a href="#">75.38 QR/NR swtch spd</a> .	1074201904
	Const	Bit pointer setting (see <a href="#">Terms and abbreviations</a> on page <a href="#">115</a> ).	-
	Pointer		
75.38	QR/NR swtch spd	When parameter <a href="#">75.37 QR/NR swtch</a> is set to <i>Speed</i> , this parameter defines the speed at which quick ramp set 1 or set 2 is changed to the standard ramp set defined by parameters <a href="#">22.02 Acc time</a> and <a href="#">22.03 Dec time</a> . The ramp set is changed when the actual speed exceeds this switchover speed.	
	0.0 ... 30000.0 rpm	Switchover speed.	10 = 1 rpm

No.	Name/Value	Description	FbEq
<b>76 MF communication</b>		Communication configuration for applications consisting of multiple pumps with dedicated drives.	
76.01	Enable MF comm	Enables/disables drive-to-drive communication through the D2D link. <b>Note:</b> Drive-to-drive communication can only be enabled if the embedded fieldbus interface is disabled (parameter <a href="#">58.01 Protocol ena sel</a> is set to <i>Disabled</i> ).	
	No	Drive-to-drive communication disabled.	0
	Yes	Drive-to-drive communication enabled.	1
76.02	Pump node	Node number of the drive on the drive-to-drive link. <b>Notes:</b> <ul style="list-style-type: none"> <li>• Each drive on the link must have a unique node number.</li> <li>• If the drive is not given a priority class, the node number is also used in determining the starting order of pumps.</li> </ul>	
	0...8	Node number.	1 = 1
76.03	Master enable	Determines (or defines a source that determines) if the drive is allowed to be master on the drive-to-drive link.	
	No	The drive can only be a follower on the drive-to-drive link.	0
	Yes	The drive is allowed to be master on the drive-to-drive link.	1
	Const	Bit pointer setting (see <a href="#">Terms and abbreviations</a> on page <a href="#">115</a> ).	-
	Pointer		
76.04	Pump prior sel	Defines a source that chooses a start priority for the drive. Two preset priorities are available: either can be selected permanently, or a digital signal source used to switch between the two presets. Please note that the Autochange feature will attempt to equalize the duty between drives with the same priority rather than between drives with different priorities. With a digital source, 0 = priority defined by <a href="#">76.05 Prior choice 1</a> 1 = priority defined by <a href="#">76.06 Prior choice 2</a> .	
	Choice 1	Start priority defined by parameter <a href="#">76.05 Prior choice 1</a> .	0
	Choice 2	Start priority defined by parameter <a href="#">76.06 Prior choice 2</a> .	1
	DI1	Digital input DI1 (as indicated by <a href="#">02.01 DI status</a> , bit 0).	1073742337
	DI2	Digital input DI2 (as indicated by <a href="#">02.01 DI status</a> , bit 1).	1073807873
	DI3	Digital input DI3 (as indicated by <a href="#">02.01 DI status</a> , bit 2).	1073873409
	DI4	Digital input DI4 (as indicated by <a href="#">02.01 DI status</a> , bit 3).	1073938945
	DI5	Digital input DI5 (as indicated by <a href="#">02.01 DI status</a> , bit 4).	1074004481
	Const	Bit pointer setting (see <a href="#">Terms and abbreviations</a> on page <a href="#">115</a> ).	-
	Pointer		
76.05	Prior choice 1	Priority preset 1. See parameter <a href="#">76.04 Pump prior sel</a> .	
	1...4	Priority preset 1.	1 = 1
76.06	Prior choice 2	Priority preset 2. See parameter <a href="#">76.04 Pump prior sel</a> .	
	1...4	Priority preset 2.	1 = 1

No.	Name/Value	Description	FbEq
76.07	Mstr loss action	If the drive is a follower, cannot find a master on the drive-to-drive link, and is not itself allowed to be master, it will wait for the delay specified by parameter <a href="#">76.08 Mstr loss delay</a> , then proceed as defined by this parameter. The drive will also generate an alarm.	
	Const speed	The drive continues running and adopts the speed defined by parameter <a href="#">26.08 Const speed3</a> .	0
	Last speed	The drive continues running at the last valid reference received from the master.	1
	Stop	The drive stops running. When the drive finds a master, it will start again upon a request from the master.	2
76.08	Mstr loss delay	Delay for a master loss situation. See parameter <a href="#">76.07 Mstr loss action</a> .	
	0...3600 s	Delay for master loss.	1 = 1 s
76.09	Start order corr	<p>Whenever the application requires more pumping volume, additional drives are started. The starting order is dependent on the priority setting of the drive (parameters <a href="#">76.04...76.06</a>). Whenever several drives have the same priority, the one with the lowest node number (parameter <a href="#">76.02</a>) is started first by default.</p> <p>The Autochange function can be used to automatically rotate the starting order within each priority group. Drives running before the Autochange may continue to run so that the new starting order cannot be applied immediately; this parameter defines the method with which the drive order of priority is corrected.</p> <p><i>Example:</i> One pump is running. If necessary, additional pumps are started in the following order:</p> <div style="text-align: center;"> </div> <p>While there is constant flow demand (and a pump must be running), the Autochange function is activated, rotating the starting order within each priority. After Autochange, the order is as follows:</p> <div style="text-align: center;"> </div> <p>The desired order, however, is this:</p> <div style="text-align: center;"> </div>	

## 270 Parameters

No.	Name/Value	Description	FbEq
		The selections of this parameter define how the desired order is achieved.	
	Optimal	Drive order of priority is corrected only when the number of drives needs to be increased or decreased by the master as required by the process.	0
	Instant chng	Drive order of priority is corrected as soon as a new starting order is generated, for example when the Autochange conditions are met. The order is corrected by stopping low-priority drives. Higher-priority drives are then started as required by the process.	1
76.10	Master location	Defines whether the master status is passed on with each started drive or not.	
	Stable	The first drive started will remain the master as long as possible, until, for example, the drive is no longer allowed to be master (by parameter <a href="#">76.03 Master enable</a> ), or the drive trips on a fault.	0
	In start	The drive that was started last, and is allowed to be master by parameter <a href="#">76.03 Master enable</a> , is the master.	1
76.11	Shared IO enable	Determines whether shared signals broadcast on the drive-to-drive link (if any) are received by the drive.	
	No	Shared signals not received.	0
	Yes	Shared signals received. The signals received are shown by parameters <a href="#">02.42 Shared DI</a> , <a href="#">02.43 Shared signal 1</a> and <a href="#">02.44 Shared signal 2</a> .	1
76.12	Set as source	Determines whether the drive broadcasts shared signals on the drive-to-drive link or not.	
	No	The drive does not broadcast shared signals.	0
	Yes	The drive broadcasts the signals selected by parameters <a href="#">76.13 Shared signal 1</a> and <a href="#">76.14 Shared signal 2</a> as shared signals on the drive-to-drive link. Digital signals are shared automatically.	1
	Const	Bit pointer setting (see <a href="#">Terms and abbreviations</a> on page <a href="#">115</a> ).	-
	Pointer		
76.13	Shared signal 1	Selects a signal to be broadcast as shared signal 1 on the drive-to-drive link.	
	AI1 scaled	<a href="#">02.05 AI1 scaled</a> (see page <a href="#">120</a> ).	1073742341
	AI2 scaled	<a href="#">02.07 AI2 scaled</a> (see page <a href="#">120</a> ).	1073742343
	Proc act	<a href="#">04.01 Act val</a> (see page <a href="#">129</a> ).	1073742849
	Pointer	Value pointer setting (see <a href="#">Terms and abbreviations</a> on page <a href="#">115</a> ).	-
76.14	Shared signal 2	Selects a signal to be broadcast as shared signal 2 on the drive-to-drive link.	
	AI1 scaled	<a href="#">02.05 AI1 scaled</a> (see page <a href="#">120</a> ).	1073742341
	AI2 scaled	<a href="#">02.07 AI2 scaled</a> (see page <a href="#">120</a> ).	1073742343
	Setpoint	<a href="#">04.02 Setpoint</a> (see page <a href="#">129</a> ).	1073742850
	Pointer	Value pointer setting (see <a href="#">Terms and abbreviations</a> on page <a href="#">115</a> ).	-

No.	Name/Value	Description	FbEq
76.15	Share lost actn	Defines the action taken by the drive if no shared signals are received for the time defined by parameter <a href="#">76.16 Share lost delay</a> . (This parameter is only effective if parameter <a href="#">76.11 Shared IO enable</a> is set to <i>Yes</i> .)	
	Alarm	The drive generates an alarm, <i>MF NO SHARED DATA</i> .	0
	Fault	The drive trips on a fault, <i>MF NO SHARED DATA</i> .	1
	Const speed	The drive continues running and adopts the speed defined by parameter <a href="#">26.08 Const speed3</a> .	2
	Last speed	The drive continues running at the last valid reference received from the master.	3
76.16	Share lost delay	Delay for a shared signal loss situation. See parameter <a href="#">76.15 Share lost actn</a> .	
	0...3600 s	Delay for shared signal loss.	1 = 1 s
<b>77 Pump sleep</b>		Sleep function settings. See also section <a href="#">Sleep function</a> on page 61.	
77.01	Sleep mode sel	Enables/disables the sleep function.	
	Not used	Sleep function disabled.	0
	Internal	The signal selected by parameter <a href="#">77.02 Sleep int sel</a> is compared to the value of <a href="#">77.03 Sleep level</a> . If the signal remains below this value longer than the sleep delay ( <a href="#">77.04 Sleep delay</a> ), the drive shifts to sleep mode. The sleep and wake-up delays ( <a href="#">77.04 Sleep delay</a> and <a href="#">77.11 Wake up delay</a> ) are in force.	1
	External	The sleep function is activated by the source selected by parameter <a href="#">77.05 Sleep ext sel</a> . The sleep delay ( <a href="#">77.04 Sleep delay</a> ) is not in force but the wake-up delay ( <a href="#">77.11 Wake up delay</a> ) is.	2
	Int+ext	When the source selected by parameter <a href="#">77.05 Sleep ext sel</a> is "1", the sleep function works as with the setting <i>Internal</i> . When the source selected by parameter <a href="#">77.05 Sleep ext sel</a> is "0", the sleep function is disabled.	3
	Soft ext	When the source selected by parameter <a href="#">77.05 Sleep ext sel</a> is "0", the sleep function is disabled. When the source selected by parameter <a href="#">77.05 Sleep ext sel</a> is "1", the input of the PID controller is set to 0. After the drive enters sleep mode, it will not wake up until the signal returns to "0".	4
77.02	Sleep int sel	Selects the internal signal to be monitored by the sleep function when parameter <a href="#">77.01 Sleep mode sel</a> is set to <i>Internal</i> , <i>Int+ext</i> or <i>Soft ext</i> .	
	Speed	<a href="#">01.01 Motor speed rpm</a> (see page 118).	1073742081
	Speed %	<a href="#">01.02 Motor speed %</a> (see page 118).	1073742082
	AI1	<a href="#">02.04 AI1</a> (see page 120).	1073742340
	AI1 scaled	<a href="#">02.05 AI1 scaled</a> (see page 120).	1073742341
	AI2	<a href="#">02.06 AI2</a> (see page 120).	1073742342
	AI2 scaled	<a href="#">02.07 AI2 scaled</a> (see page 120).	1073742343
	Proc act	<a href="#">04.01 Act val</a> (see page 129).	1073742849
	Flow act	<a href="#">05.05 Flow act</a> (see page 131).	1073743109



## 272 Parameters

No.	Name/Value	Description	FbEq
	Pointer	Value pointer setting (see <a href="#">Terms and abbreviations</a> on page 115).	-
77.03	Sleep level	Defines the start limit for the sleep function when parameter <a href="#">77.01 Sleep mode sel</a> is set to <i>Internal</i> , <i>Int+ext</i> or <i>Soft ext</i> .	
	-32768.00 ... 32768.00	Sleep start level.	100 = 1
77.04	Sleep delay	Defines the delay for the sleep start function. See parameter <a href="#">77.03 Sleep level</a> . When the monitored signal falls below the sleep level, the counter starts. When the signal exceeds the sleep level, the counter resets.	
	0 ... 12600 s	Sleep start delay.	1 = 1 s
77.05	Sleep ext sel	Defines a source that is used by parameter <a href="#">77.01 Sleep mode sel</a> , selections <i>External</i> , <i>Int+ext</i> and <i>Soft ext</i> . See the descriptions of those selections for the usage of this signal source.	
	Not used	No source selected.	0
	DI1	Digital input DI1 (as indicated by <a href="#">02.01 DI status</a> , bit 0).	1073742337
	DI2	Digital input DI2 (as indicated by <a href="#">02.01 DI status</a> , bit 1).	1073807873
	DI3	Digital input DI3 (as indicated by <a href="#">02.01 DI status</a> , bit 2).	1073873409
	DI4	Digital input DI4 (as indicated by <a href="#">02.01 DI status</a> , bit 3).	1073938945
	DI5	Digital input DI5 (as indicated by <a href="#">02.01 DI status</a> , bit 4).	1074004481
	Const	Bit pointer setting (see <a href="#">Terms and abbreviations</a> on page 115).	-
	Pointer		
77.06	Sleep boost step	When the drive is entering sleep mode, the setpoint is increased by this percentage for the time defined by parameter <a href="#">77.07 Sleep boost time</a> . No auxiliary pumps are started. If active, sleep boost is aborted when the drive wakes up. See the diagram in section <a href="#">Sleep function</a> (starting page 61).	
	0.00 ... 32767.00 %	Sleep boost step.	100 = 1%
77.07	Sleep boost time	Sets the boost time for the sleep boost step defined by parameter <a href="#">77.06 Sleep boost step</a> .	
	0...100 s	Sleep boost time.	1 = 1 s

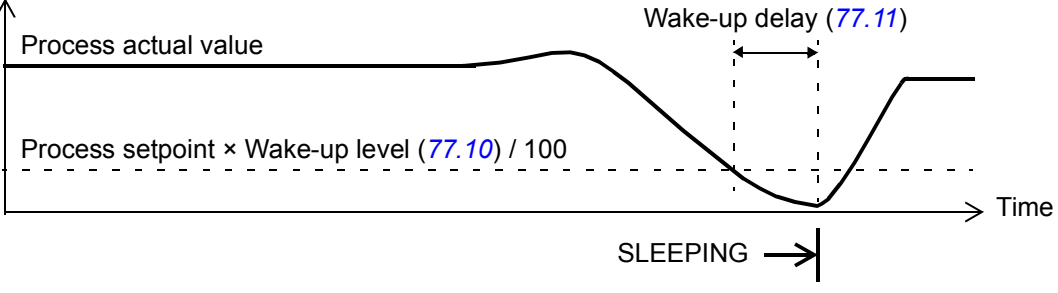
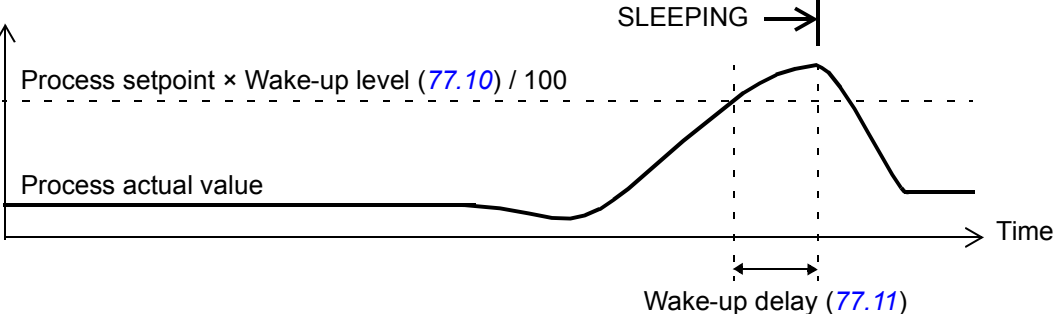
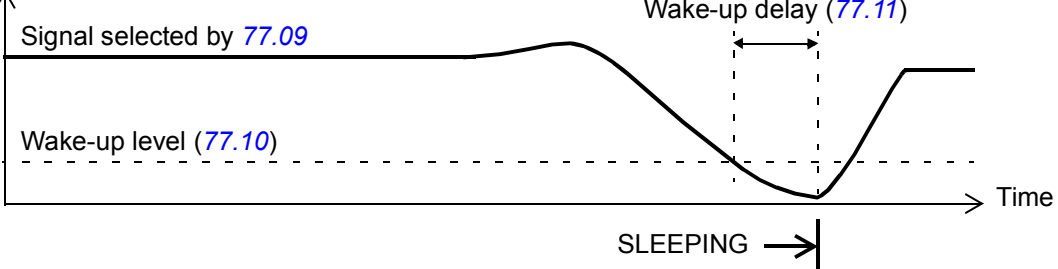

No.	Name/Value	Description	FbEq
77.08	Wake up mode sel	<p>Selects the signal that is compared to the wake up level <a href="#">77.10 Wake up level</a>, and the condition that must be true for the drive to wake up.</p> <p>If the selected condition does not remain true until the wake-up delay (<a href="#">77.11 Wake up delay</a>) expires, the delay counter is reset.</p>	
	Wake > ref	<p>If the process actual value (see group <a href="#">28 Procact sel</a>) remains below the process setpoint (see group <a href="#">29 Setpoint sel</a>) multiplied by the wake-up level for longer than the wake-up delay (<a href="#">77.11 Wake up delay</a>), the drive wakes up. See the diagram below.</p>	0
			
	Wake < ref	<p>If the process actual value (see group <a href="#">28 Procact sel</a>) remains above the process setpoint (see group <a href="#">29 Setpoint sel</a>) multiplied by the wake-up level for longer than the wake-up delay (<a href="#">77.11 Wake up delay</a>), the drive wakes up. See the diagram below.</p>	1
			
	Wake > ext	<p>If the signal selected by parameter <a href="#">77.09 Wake up ext src</a> remains below the wake-up level (<a href="#">77.10 Wake up level</a>) longer than the wake-up delay (<a href="#">77.11 Wake up delay</a>), the drive wakes up.</p>	2
			

No.	Name/Value	Description	FbEq
	Wake < ext	If the signal selected by parameter <a href="#">77.09 Wake up ext src</a> remains above the wake-up level ( <a href="#">77.10 Wake up level</a> ) longer than the wake-up delay ( <a href="#">77.11 Wake up delay</a> ), the drive wakes up.	3
77.09	Wake up ext src	Selects the signal source for parameter <a href="#">77.09 Wake up ext src</a> , selections <a href="#">Wake &gt; ext</a> and <a href="#">Wake &lt; ext</a> .	
	AI1	<a href="#">02.04 AI1</a> (see page 120).	1073742340
	AI1 scaled	<a href="#">02.05 AI1 scaled</a> (see page 120).	1073742341
	AI2	<a href="#">02.06 AI2</a> (see page 120).	1073742342
	AI2 scaled	<a href="#">02.07 AI2 scaled</a> (see page 120).	1073742343
	Proc act	<a href="#">04.01 Act val</a> (see page 129).	1073742849
	Flow act	<a href="#">05.05 Flow act</a> (see page 131).	1073743109
	Pointer	Value pointer setting (see <a href="#">Terms and abbreviations</a> on page 115).	-
77.10	Wake up level	Defines the wake-up limit for the sleep function. See the selections of parameter <a href="#">77.08 Wake up mode sel</a> .	
	-32768.00 ... 32767.00	Wake-up level.	100 = 1
77.11	Wake up delay	Defines the wake-up delay for the sleep function. See the selections of parameter <a href="#">77.08 Wake up mode sel</a> .	
	0 ... 100 s	Wake-up delay.	1 = 1 s

<b>78 Pump autochange</b>		Pump Autochange and interlock settings. See also section <a href="#">Autochange</a> page 64.	
78.01	Autochg style	Selects whether the Autochange function is used.	
	No	Autochange disabled. The drive with the lowest node number is started first.	0
	Fixed	Autochange will occur at intervals defined by parameter <a href="#">78.05 Autochg interval</a> with the following provisions: - In traditional pump control, the drive speed must fall below the value defined by <a href="#">78.04 Autochg level</a> . - In multipump control, the change is made according to parameter <a href="#">76.09 Start order corr</a> . <b>Note:</b> The timing is based on drive power-on time (rather than drive running time).	1
	Hourcount	The pumping duty is distributed among the pumps according to parameters <a href="#">04.28 Pump runtime</a> , <a href="#">78.14 Runtime change</a> and <a href="#">78.15 Runtime diff</a> .	2
	All stop	Autochange will occur when all the pumps are stopped.	3

No.	Name/Value	Description	FbEq
78.02	Autochg trad	Selects whether only auxiliary pumps or all pumps are affected by the Autochange function. This parameter is only valid in traditional pump control.	
	All	All pumps are affected by the Autochange function.	0
	Aux	Only auxiliary (direct-on-line) pumps are affected by the Autochange function.	1
78.03	Interlock mode	<p>Defines whether interlocks are used or not. This parameter is only valid in traditional pump control.</p> <p> <b>WARNING!</b> Use of the Autochange function also requires the use of interlocks.</p> <p>Interlocks are used in applications where one pump at a time is connected to the output of the drive. The remaining pumps are powered from the supply and started/stopped by the relay outputs of the drive. A contact of the manual on/off switch (or protective device, such as a thermal relay) of each pump is wired to the selected interlock input. The logic will detect if the pump is unavailable and start the next available pump instead. The interlock inputs are defined by parameters <a href="#">78.06...78.13</a>.</p> <p>If the interlock circuit of the speed-regulated pump (the pump connected to the drive output) is switched off, the pump is stopped and all relay outputs are de-energized. Then the drive will restart. The next available pump in the Autochange sequence will be started as the regulated pump.</p> <p>If the interlock circuit of a direct-on-line pump is switched off, the drive will not try to start that pump until the interlock circuit is switched on again. The other pumps will operate normally.</p>	
	Not used	Interlocks not used.	0
	On	Interlocks in use.	1

No.	Name/Value	Description	FbEq
78.04	Autochg level	<p>Speed limit for the Autochange function when parameter <a href="#">78.01 Autochg style</a> is set to <i>Fixed</i>.</p> <p>This parameter is only valid in traditional pump control. The pump starting sequence is changed when the Autochange interval has elapsed and the drive speed is below this limit. Autochanging is indicated by a warning on the control panel display.</p> <p><b>Notes:</b></p> <ul style="list-style-type: none"> <li>The value of this parameter must be within the allowed range (between minimum and maximum limits). Otherwise no Autochanging is possible.</li> <li>When the drive is powered off, the values of the starting sequence counter and the Autochange interval counter are stored. The counters will continue from these values after the drive is powered on.</li> </ul> <p><i>Example:</i> There are three pumps in a system (parameter <a href="#">75.02 Nbr of pumps</a> is set to 3). Autochange level is set to 1500 rpm.</p> <p>An Autochange occurs when the drive speed is below 1500 rpm, and the Autochange interval has elapsed since the previous Autochange. Upon the Autochange,</p> <ol style="list-style-type: none"> <li>All pumps are stopped</li> <li>The starting sequence is incremented (from 1-2-3 to 2-3-1, etc.)</li> <li>The contactor that controls the speed-regulated pump is closed</li> <li>The delay set by parameter <a href="#">75.25 Drive start dly</a> passes</li> <li>The speed-regulated pump is energized and normal operation starts.</li> </ol> <p>If the Autochange level is 0 rpm and the interval has elapsed, Autochange will occur during a stop (for example, when the Sleep function is active).</p>	
	0...32767 rpm	Autochange level.	1 = 1 rpm
78.05	Autochg interval	Specifies the Autochange interval. See parameter <a href="#">78.04 Autochg level</a> .	
	0.00 ... 1092.25 h	Autochange interval.	100 = 1 h
78.06	Interlock pump 1	Selects the input (or signal) for status of pump 1. When the input is 1, the drive assumes the pump is in use and can be started.	
	Not used	The interlock is off, meaning that the pump is not in use.	0
	On	The interlock is on, meaning that the pump is ready for use.	1
	DI1	Digital input DI1 (as indicated by <a href="#">02.01 DI status</a> , bit 0).	1073742337
	DI2	Digital input DI2 (as indicated by <a href="#">02.01 DI status</a> , bit 1).	1073807873
	DI3	Digital input DI3 (as indicated by <a href="#">02.01 DI status</a> , bit 2).	1073873409
	DI4	Digital input DI4 (as indicated by <a href="#">02.01 DI status</a> , bit 3).	1073938945
	DI5	Digital input DI5 (as indicated by <a href="#">02.01 DI status</a> , bit 4).	1074004481
	Const	Bit pointer setting (see <a href="#">Terms and abbreviations</a> on page 115).	-
	Pointer		
78.07	Interlock pump 2	Selects the input (or signal) for status of pump 2. When the input is 1, the drive assumes the pump is in use and can be started.	
	Not used	The interlock is off, meaning that the pump is not in use.	0

No.	Name/Value	Description	FbEq
	On	The interlock is on, meaning that the pump is ready for use.	1
	DI1	Digital input DI1 (as indicated by <a href="#">02.01 DI status</a> , bit 0).	1073742337
	DI2	Digital input DI2 (as indicated by <a href="#">02.01 DI status</a> , bit 1).	1073807873
	DI3	Digital input DI3 (as indicated by <a href="#">02.01 DI status</a> , bit 2).	1073873409
	DI4	Digital input DI4 (as indicated by <a href="#">02.01 DI status</a> , bit 3).	1073938945
	DI5	Digital input DI5 (as indicated by <a href="#">02.01 DI status</a> , bit 4).	1074004481
	Const	Bit pointer setting (see <a href="#">Terms and abbreviations</a> on page 115).	-
	Pointer		
78.08	Interlock pump 3	Selects the input (or signal) for status of pump 3. When the input is 1, the drive assumes the pump is in use and can be started.	
	Not used	The interlock is off, meaning that the pump is not in use.	0
	On	The interlock is on, meaning that the pump is ready for use.	1
	DI1	Digital input DI1 (as indicated by <a href="#">02.01 DI status</a> , bit 0).	1073742337
	DI2	Digital input DI2 (as indicated by <a href="#">02.01 DI status</a> , bit 1).	1073807873
	DI3	Digital input DI3 (as indicated by <a href="#">02.01 DI status</a> , bit 2).	1073873409
	DI4	Digital input DI4 (as indicated by <a href="#">02.01 DI status</a> , bit 3).	1073938945
	DI5	Digital input DI5 (as indicated by <a href="#">02.01 DI status</a> , bit 4).	1074004481
	Const	Bit pointer setting (see <a href="#">Terms and abbreviations</a> on page 115).	-
	Pointer		
78.09	Interlock pump 4	Selects the input (or signal) for status of pump 4. When the input is 1, the drive assumes the pump is in use and can be started.	
	Not used	The interlock is off, meaning that the pump is not in use.	0
	On	The interlock is on, meaning that the pump is ready for use.	1
	DI1	Digital input DI1 (as indicated by <a href="#">02.01 DI status</a> , bit 0).	1073742337
	DI2	Digital input DI2 (as indicated by <a href="#">02.01 DI status</a> , bit 1).	1073807873
	DI3	Digital input DI3 (as indicated by <a href="#">02.01 DI status</a> , bit 2).	1073873409
	DI4	Digital input DI4 (as indicated by <a href="#">02.01 DI status</a> , bit 3).	1073938945
	DI5	Digital input DI5 (as indicated by <a href="#">02.01 DI status</a> , bit 4).	1074004481
	Const	Bit pointer setting (see <a href="#">Terms and abbreviations</a> on page 115).	-
	Pointer		
78.10	Interlock pump 5	Selects the input (or signal) for status of pump 5. When the input is 1, the drive assumes the pump is in use and can be started.	
	Not used	The interlock is off, meaning that the pump is not in use.	0
	On	The interlock is on, meaning that the pump is ready for use.	1
	DI1	Digital input DI1 (as indicated by <a href="#">02.01 DI status</a> , bit 0).	1073742337
	DI2	Digital input DI2 (as indicated by <a href="#">02.01 DI status</a> , bit 1).	1073807873
	DI3	Digital input DI3 (as indicated by <a href="#">02.01 DI status</a> , bit 2).	1073873409
	DI4	Digital input DI4 (as indicated by <a href="#">02.01 DI status</a> , bit 3).	1073938945
	DI5	Digital input DI5 (as indicated by <a href="#">02.01 DI status</a> , bit 4).	1074004481

## 278 Parameters

No.	Name/Value	Description	FbEq
	Const	Bit pointer setting (see <a href="#">Terms and abbreviations</a> on page 115).	-
	Pointer		
78.11	Interlock pump 6	Selects the input (or signal) for status of pump 6. When the input is 1, the drive assumes the pump is in use and can be started.	
	Not used	The interlock is off, meaning that the pump is not in use.	0
	On	The interlock is on, meaning that the pump is ready for use.	1
	DI1	Digital input DI1 (as indicated by <a href="#">02.01 DI status</a> , bit 0).	1073742337
	DI2	Digital input DI2 (as indicated by <a href="#">02.01 DI status</a> , bit 1).	1073807873
	DI3	Digital input DI3 (as indicated by <a href="#">02.01 DI status</a> , bit 2).	1073873409
	DI4	Digital input DI4 (as indicated by <a href="#">02.01 DI status</a> , bit 3).	1073938945
	DI5	Digital input DI5 (as indicated by <a href="#">02.01 DI status</a> , bit 4).	1074004481
	Const	Bit pointer setting (see <a href="#">Terms and abbreviations</a> on page 115).	-
	Pointer		
78.12	Interlock pump 7	Selects the input (or signal) for status of pump 7. When the input is 1, the drive assumes the pump is in use and can be started.	
	Not used	The interlock is off, meaning that the pump is not in use.	0
	On	The interlock is on, meaning that the pump is ready for use.	1
	DI1	Digital input DI1 (as indicated by <a href="#">02.01 DI status</a> , bit 0).	1073742337
	DI2	Digital input DI2 (as indicated by <a href="#">02.01 DI status</a> , bit 1).	1073807873
	DI3	Digital input DI3 (as indicated by <a href="#">02.01 DI status</a> , bit 2).	1073873409
	DI4	Digital input DI4 (as indicated by <a href="#">02.01 DI status</a> , bit 3).	1073938945
	DI5	Digital input DI5 (as indicated by <a href="#">02.01 DI status</a> , bit 4).	1074004481
	Const	Bit pointer setting (see <a href="#">Terms and abbreviations</a> on page 115).	-
	Pointer		
78.13	Interlock pump 8	Selects the input (or signal) for status of pump 8. When the input is 1, the drive assumes the pump is in use and can be started.	
	Not used	The interlock is off, meaning that the pump is not in use.	0
	On	The interlock is on, meaning that the pump is ready for use.	1
	DI1	Digital input DI1 (as indicated by <a href="#">02.01 DI status</a> , bit 0).	1073742337
	DI2	Digital input DI2 (as indicated by <a href="#">02.01 DI status</a> , bit 1).	1073807873
	DI3	Digital input DI3 (as indicated by <a href="#">02.01 DI status</a> , bit 2).	1073873409
	DI4	Digital input DI4 (as indicated by <a href="#">02.01 DI status</a> , bit 3).	1073938945
	DI5	Digital input DI5 (as indicated by <a href="#">02.01 DI status</a> , bit 4).	1074004481
	Const	Bit pointer setting (see <a href="#">Terms and abbreviations</a> on page 115).	-
	Pointer		
78.14	Runtime change	Enables the reset, or arbitrary setting, of <a href="#">04.28 Pump runtime</a> ... <a href="#">04.36 Trad 8 runtime</a> .	
	No	The parameter automatically reverts to this value.	0
	Set	Enables the setting of <a href="#">04.28 Pump runtime</a> to an arbitrary value.	1

No.	Name/Value	Description	FbEq
	Reset	Resets parameter <a href="#">04.28 Pump runtime</a> .	2
	Set Trad	Enables the setting of <a href="#">04.29 Trad 1 runtime</a> ... <a href="#">04.36 Trad 8 runtime</a> to an arbitrary value.	3
	Reset Trad 1	Resets parameter <a href="#">04.29 Trad 1 runtime</a> .	4
	Reset Trad 2	Resets parameter <a href="#">04.30 Trad 2 runtime</a> .	5
	Reset Trad 3	Resets parameter <a href="#">04.31 Trad 3 runtime</a> .	6
	Reset Trad 4	Resets parameter <a href="#">04.32 Trad 4 runtime</a> .	7
	Reset Trad 5	Resets parameter <a href="#">04.33 Trad 5 runtime</a> .	8
	Reset Trad 6	Resets parameter <a href="#">04.34 Trad 6 runtime</a> .	9
	Reset Trad 7	Resets parameter <a href="#">04.35 Trad 7 runtime</a> .	10
	Reset Trad 8	Resets parameter <a href="#">04.36 Trad 8 runtime</a> .	11
78.15	Runtime diff	Maximum pump runtime difference between drives. The control program will compare the value of the runtime counter (parameter <a href="#">04.28 Pump runtime</a> ) in each drive and attempt to keep the difference below this value.	
	0 ... 2147483647 h	Maximum runtime difference between drives.	1 = 1 h
<b>79 Level control</b>		Settings for level control applications. See also section <a href="#">Level control macro</a> (page <a href="#">108</a> ).	
79.01	Level mode	Defines whether the pump station is used for emptying or filling a container.	
	Off	Level control disabled.	0

No.	Name/Value	Description	FbEq
	Emptying	<p>The pump station is used for emptying a container. The diagram below shows the start, stop and supervision levels for emptying. For simplicity, only three pumps are shown. Parameter <a href="#">79.02 Stopping mode</a> is assumed to be set to <i>Common stop</i>; <a href="#">79.16 Start stop delay</a> is assumed to be set to 0.00 seconds.</p>	1



No.	Name/Value	Description	FbEq
	Filling	The pump station is used for filling a container. The diagram below shows the start, stop and supervision levels for filling. For simplicity, only three pumps are shown. Parameter <i>79.02 Stopping mode</i> is assumed to be set to <i>Common stop</i> ; <i>79.16 Start stop delay</i> is assumed to be set to 0.00 seconds.	2
Level (process actual value)			

## 282 Parameters

No.	Name/Value	Description	FbEq
79.02	Stopping mode	Selects whether the pumps are stopped simultaneously or individually.	
	Stable level	When the start level of a pump (parameters <a href="#">79.06 Start 1 level...79.13 Start 8 level</a> ) is reached, the master drive waits for the level delay (parameter <a href="#">79.16 Start stop delay</a> ) to elapse, then stops the pump.	0
	Common stop	All the pumps running will continue to run until the stop level (parameter <a href="#">79.05 Stop level</a> ) is reached. All pumps will then be stopped one by one at intervals defined by parameter <a href="#">79.16 Start stop delay</a> .	1
79.03	Low level	Defines the low level for level control. In emptying mode, when the measured level falls below the low level, all pumps stop (if not stopped already). In filling mode, when the measured level falls below the low level, all pumps start running at the speed defined by parameter <a href="#">79.19 High speed</a> . See the diagrams at parameter <a href="#">79.01 Level mode</a> .	
	0.00 ... 32768.00%	Low level.	100 = 1%
79.04	Low switch	Selects a digital source that is used to determine that the liquid level in the container has fallen very low. When the source becomes active (1), an alarm, <b>LC TANK EMPTY</b> is given. The alarm is cleared when the source switches off.	
	Not used	No low switch used.	0
	DI1	Digital input DI1 (as indicated by <a href="#">02.01 DI status</a> , bit 0).	1073742337
	DI2	Digital input DI2 (as indicated by <a href="#">02.01 DI status</a> , bit 1).	1073807873
	DI3	Digital input DI3 (as indicated by <a href="#">02.01 DI status</a> , bit 2).	1073873409
	DI4	Digital input DI4 (as indicated by <a href="#">02.01 DI status</a> , bit 3).	1073938945
	DI5	Digital input DI5 (as indicated by <a href="#">02.01 DI status</a> , bit 4).	1074004481
	Const	Bit pointer setting (see <a href="#">Terms and abbreviations</a> on page <a href="#">115</a> ).	-
	Pointer		
79.05	Stop level	Defines the stop level for the pump station. If parameter <a href="#">79.02 Stopping mode</a> is set to <a href="#">Stable level</a> , pumps 3 and 2, for example, are stopped when <a href="#">79.08 Start 3 level</a> and <a href="#">79.07 Start 2 level</a> are reached respectively; pump 1 is stopped at the stop level. If parameter <a href="#">79.02 Stopping mode</a> is set to <a href="#">Common stop</a> , all pumps will continue to run until the stop level is reached. See the diagrams at parameter <a href="#">79.01 Level mode</a> .	
	0.00 ... 32768.00%	Stop level.	100 = 1%
79.06	Start 1 level	Defines the start level for pump 1. See the diagrams at parameter <a href="#">79.01 Level mode</a> .	
	0.00 ... 32768.00%	Start level for pump 1.	100 = 1%
79.07	Start 2 level	Defines the start level for pump 2. This is also the stop level for the pump unless <a href="#">Common stop</a> is selected at parameter <a href="#">79.02 Stopping mode</a> . See the diagrams at parameter <a href="#">79.01 Level mode</a> .	
	0.00 ... 32768.00%	Start level for pump 2.	100 = 1%

No.	Name/Value	Description	FbEq
79.08	Start 3 level	Defines the start level for pump 3. This is also the stop level for the pump unless <i>Common stop</i> is selected at parameter <a href="#">79.02 Stopping mode</a> . See the diagrams at parameter <a href="#">79.01 Level mode</a> .	
	0.00 ... 32768.00%	Start level for pump 3.	100 = 1%
79.09	Start 4 level	Defines the start level for pump 4. This is also the stop level for the pump unless <i>Common stop</i> is selected at parameter <a href="#">79.02 Stopping mode</a> . See the diagrams at parameter <a href="#">79.01 Level mode</a> .	
	0.00 ... 32768.00%	Start level for pump 4.	100 = 1%
79.10	Start 5 level	Defines the start level for pump 5. This is also the stop level for the pump unless <i>Common stop</i> is selected at parameter <a href="#">79.02 Stopping mode</a> . See the diagrams at parameter <a href="#">79.01 Level mode</a> .	
	0.00 ... 32768.00%	Start level for pump 5.	100 = 1%
79.11	Start 6 level	Defines the start level for pump 6. This is also the stop level for the pump unless <i>Common stop</i> is selected at parameter <a href="#">79.02 Stopping mode</a> . See the diagrams at parameter <a href="#">79.01 Level mode</a> .	
	0.00 ... 32768.00%	Start level for pump 6.	100 = 1%
79.12	Start 7 level	Defines the start level for pump 7. This is also the stop level for the pump unless <i>Common stop</i> is selected at parameter <a href="#">79.02 Stopping mode</a> . See the diagrams at parameter <a href="#">79.01 Level mode</a> .	
	0.00 ... 32768.00%	Start level for pump 7.	100 = 1%
79.13	Start 8 level	Defines the start level for pump 8. This is also the stop level for the pump unless <i>Common stop</i> is selected at parameter <a href="#">79.02 Stopping mode</a> . See the diagrams at parameter <a href="#">79.01 Level mode</a> .	
	0.00 ... 32768.00%	Start level for pump 8.	100 = 1%
79.14	High level	In emptying mode, when the measured level exceeds this value, all pumps start running at the speed defined by parameter <a href="#">79.19 High speed</a> . In filling mode, when the measured level exceeds this value, all pumps stop (if not stopped already).	
	0.00 ... 32768.00%	High level.	100 = 1%
79.15	High switch	Selects a digital source that is used to determine that the liquid level in the container has risen very high. When the source switches on, an alarm, <i>LC TANK FULL</i> is given. The alarm is cleared when the source switches off.	
	Not used	No high switch used.	0
	D11	Digital input DI1 (as indicated by <a href="#">02.01 DI status</a> , bit 0).	1073742337
	D12	Digital input DI2 (as indicated by <a href="#">02.01 DI status</a> , bit 1).	1073807873
	D13	Digital input DI3 (as indicated by <a href="#">02.01 DI status</a> , bit 2).	1073873409
	D14	Digital input DI4 (as indicated by <a href="#">02.01 DI status</a> , bit 3).	1073938945
	D15	Digital input DI5 (as indicated by <a href="#">02.01 DI status</a> , bit 4).	1074004481
	Const	Bit pointer setting (see <a href="#">Terms and abbreviations</a> on page <a href="#">115</a> ).	-
	Pointer		

No.	Name/Value	Description	FbEq
79.16	Start stop delay	Sets a delay for stopping and starting a pump (or pumps). Whenever a start or stop level is reached, this delay must elapse before any action is taken.	
	0 ... 3600 s	Start/stop delay.	1 = 1 s
79.17	Random coef	Randomizes the start levels (parameters <a href="#">79.06...79.13</a> ) to avoid caking on the walls of the container. For example, with this parameter set to 10.0%, the actual start level is randomized in the range of (start level - 10%) ... (start level + 10%).	
	0.0 ... 10.0%	Random coefficient.	10 = 1%
79.18	Normal speed	In emptying mode, defines the pump speed when the measured level is below the high level setting (parameter <a href="#">79.14</a> ), and the high switch (parameter <a href="#">79.15</a> ) is not active. In filling mode, defines the pump speed when the measured level is above the low level setting (parameter <a href="#">79.03</a> ), and low switch (parameter <a href="#">79.04</a> ) is not active. Ideally, this parameter should be set at the optimal operating point of the pump.	
	0.0...32767.0 rpm	Normal running speed.	10 = 1%
79.19	High speed	In emptying mode, defines the pump speed when the measured level exceeds the level defined by parameter <a href="#">79.14 High level</a> , or when the high limit switch (parameter <a href="#">79.15</a> ) is active. In filling mode, sets the pump speed when the measured level falls below the level defined by parameter <a href="#">79.03 Low level</a> , or when the low limit switch (parameter <a href="#">79.04</a> ) is active. See the diagrams at parameter <a href="#">79.01 Level mode</a> .	
	0.0...32767.0 rpm	High running speed.	10 = 1%
<b>80 Flow calculation</b>		Settings for the flow calculation function. See also section <a href="#">Flow calculation</a> on page <a href="#">65</a> .	
80.01	Flow calc mode	Enables the flow calculation function, and determines whether a PQ (power/flow) curve or HQ (head/flow) curve is used for the calculation. The curves are defined by parameters <a href="#">80.04...80.23</a> .	
	Not used	Flow calculation not used.	0
	PQ curve	The PQ curve is used for flow calculation.	1
	HQ curve	The HQ curve is used for flow calculation.	2
	Both	Both the HQ and PQ curves are used for flow calculation. The transition point between the curves is set by parameter <a href="#">80.24 HQ PQ brk point</a> .	3
80.02	Pump inlet sel	Selects the analog input (or other signal source) used for pump inlet pressure measurement.	
	Zero	No input selected (no pressure sensor available).	0
	AI1 scaled	<a href="#">02.05 AI1 scaled</a> (see page <a href="#">120</a> ).	1073742341
	AI2 scaled	<a href="#">02.07 AI2 scaled</a> (see page <a href="#">120</a> ).	1073742343
	AI3 scaled	<a href="#">02.09 AI3 scaled</a> (see page <a href="#">120</a> ).	1073742345
	AI4 scaled	<a href="#">02.11 AI4 scaled</a> (see page <a href="#">120</a> ).	1073742347
	AI5 scaled	<a href="#">02.13 AI5 scaled</a> (see page <a href="#">120</a> ).	1073742349

No.	Name/Value	Description	FbEq
	Pointer	Value pointer setting (see <a href="#">Terms and abbreviations</a> on page 115).	-
80.03	Pump outlet sel	Selects the analog input (or other signal source) used for pump outlet pressure measurement.	
	Zero	No input selected (no pressure sensor available).	0
	AI1 scaled	<a href="#">02.05 AI1 scaled</a> (see page 120).	1073742341
	AI2 scaled	<a href="#">02.07 AI2 scaled</a> (see page 120).	1073742343
	AI3 scaled	<a href="#">02.09 AI3 scaled</a> (see page 120).	1073742345
	AI4 scaled	<a href="#">02.11 AI4 scaled</a> (see page 120).	1073742347
	AI5 scaled	<a href="#">02.13 AI5 scaled</a> (see page 120).	1073742349
	Pointer	Value pointer setting (see <a href="#">Terms and abbreviations</a> on page 115).	-
80.04	HQ curve Q1	<p>Flow rate (in cubic meters per hour) at point 1 of the HQ performance curve.</p> <p>Parameters <a href="#">80.04</a>...<a href="#">80.13</a> define the HQ performance curve of the pump for the flow calculation function. The H (head, or level) and Q (flow rate) coordinates of five points on the curve are entered. The values are provided by the pump manufacturer. All points defined should lie within the practical operating range of the pump.</p> <p>Below is an example of an HQ performance curve. The defining parameters of the first and last points are shown.</p>	
	0.00 ... 32767.00 m <sup>3</sup> /h	Flow rate at point 1 of the HQ curve.	100 = 1 m <sup>3</sup> /h
80.05	HQ curve H1	Head (in meters) at point 1 of the HQ performance curve.	
	0.00 ... 32767.00 m	Head at point 1 of the HQ curve.	100 = 1 m
80.06	HQ curve Q2	Flow rate (in cubic meters per hour) at point 2 of the HQ performance curve.	
	0.00 ... 32767.00 m <sup>3</sup> /h	Flow rate at point 2 of the HQ curve.	100 = 1 m <sup>3</sup> /h

No.	Name/Value	Description	FbEq
80.07	HQ curve H2	Head (in meters) at point 2 of the HQ performance curve.	
	0.00 ... 32767.00 m	Head at point 2 of the HQ curve.	100 = 1 m
80.08	HQ curve Q3	Flow rate (in cubic meters per hour) at point 3 of the HQ performance curve.	
	0.00 ... 32767.00 m <sup>3</sup> /h	Flow rate at point 3 of the HQ curve.	100 = 1 m <sup>3</sup> /h
80.09	HQ curve H3	Head (in meters) at point 3 of the HQ performance curve.	
	0.00 ... 32767.00 m	Head at point 3 of the HQ curve.	100 = 1 m
80.10	HQ curve Q4	Flow rate (in cubic meters per hour) at point 4 of the HQ performance curve.	
	0.00 ... 32767.00 m <sup>3</sup> /h	Flow rate at point 4 of the HQ curve.	100 = 1 m <sup>3</sup> /h
80.11	HQ curve H4	Head (in meters) at point 4 of the HQ performance curve.	
	0.00 ... 32767.00 m	Head at point 4 of the HQ curve.	100 = 1 m
80.12	HQ curve Q5	Flow rate (in cubic meters per hour) at point 5 of the HQ performance curve.	
	0.00 ... 32767.00 m <sup>3</sup> /h	Flow rate at point 5 of the HQ curve.	100 = 1 m <sup>3</sup> /h
80.13	HQ curve H5	Head (in meters) at point 5 of the HQ performance curve.	
	0.00 ... 32767.00 m	Head at point 5 of the HQ curve.	100 = 1 m
80.14	PQ curve P1	<p>Power input (in kilowatts) of pump at point 1 on the PQ performance curve.</p> <p>Parameters 80.14...80.23 define the PQ performance curve of the pump for the flow calculation function. The P (power input) and Q (flow rate) coordinates of five points on the curve are entered. The values are provided by the pump manufacturer. All points defined should lie within the practical operating range of the pump.</p> <p>Below is an example of an PQ performance curve. The defining parameters of the first and last points are shown.</p>	
	0.00 ... 32767.00 kW	Power input of pump at point 1.	100 = 1 kW

No.	Name/Value	Description	FbEq
80.15	PQ curve Q1	Flow rate (in cubic meters per hour) at point 1 on the PQ performance curve.	
	0.00 ... 32767.00 m <sup>3</sup> /h	Flow rate at point 1 of the PQ curve.	100 = 1 m <sup>3</sup> /h
80.16	PQ curve P2	Power input (in kilowatts) of pump at point 2 on the PQ performance curve.	
	0.00 ... 32767.00 kW	Power input of pump at point 2.	100 = 1 kW
80.17	PQ curve Q2	Flow rate (in cubic meters per hour) at point 2 on the PQ performance curve.	
	0.00 ... 32767.00 m <sup>3</sup> /h	Flow rate at point 2 of the PQ curve.	100 = 1 m <sup>3</sup> /h
80.18	PQ curve P3	Power input (in kilowatts) of pump at point 3 on the PQ performance curve.	
	0.00 ... 32767.00 kW	Power input of pump at point 3.	100 = 1 kW
80.19	PQ curve Q3	Flow rate (in cubic meters per hour) at point 3 on the PQ performance curve.	
	0.00 ... 32767.00 m <sup>3</sup> /h	Flow rate at point 3 of the PQ curve.	100 = 1 m <sup>3</sup> /h
80.20	PQ curve P4	Power input (in kilowatts) of pump at point 4 on the PQ performance curve.	
	0.00 ... 32767.00 kW	Power input of pump at point 4.	100 = 1 kW
80.21	PQ curve Q4	Flow rate (in cubic meters per hour) at point 4 on the PQ performance curve.	
	0.00 ... 32767.00 m <sup>3</sup> /h	Flow rate at point 4 of the PQ curve.	100 = 1 m <sup>3</sup> /h
80.22	PQ curve P5	Power input (in kilowatts) of pump at point 5 on the PQ performance curve.	
	0.00 ... 32767.00 kW	Power input of pump at point 5.	100 = 1 kW
80.23	PQ curve Q5	Flow rate (in cubic meters per hour) at point 5 on the PQ performance curve.	
	0.00 ... 32767.00 m <sup>3</sup> /h	Flow rate at point 5 of the PQ curve.	100 = 1 m <sup>3</sup> /h
80.24	HQ PQ brk point	Sets the transition point between the HQ and PQ performance curves. The PQ curve is used above this breakpoint.	
	0.00 ... 32767.00 m	Head breakpoint between HQ and PQ curves.	100 = 1 m
80.25	Pump inlet diam	The diameter of the pump inlet in meters.	
	0.00 ... 32767.00 m	Pump inlet diameter.	100 = 1 m
80.26	Pump outlet diam	The diameter of the pump outlet in meters.	
	0.00 ... 32767.00 m	Pump outlet diameter.	100 = 1 m
80.27	Sensors hgt diff	Defines the height difference between the inlet and outlet pressure sensors.	
	0.00 ... 32767.00 m	Height difference.	100 = 1 m

No.	Name/Value	Description	FbEq
80.28	Pump nom speed	Defines the nominal speed of the pump in rpm.	
	0...32767 rpm	Nominal speed of pump.	1 = 1 rpm
80.29	Density	Defines the density of the fluid to be pumped for the flow calculation function.	
	0.00 ... 32767.00 kg/m <sup>3</sup>	Fluid density.	100 = 1 kg/m <sup>3</sup>
80.30	Efficiency	Total efficiency of the motor/pump combination.	
	0.00 ... 100.00%	Efficiency.	100 = 1%
80.31	Flow calc gain	Flow calculation gain for possible calculation correction.	
	0.00 ... 32767.00	Calculation correction gain.	100 = 1
80.32	Calc low sp	Defines a speed limit below which flow is not calculated.	
	0...32767 rpm	Low speed limit for flow calculation.	1 = 1 rpm
80.33	Sum flow reset	Resets the total calculated flow counter (parameter <a href="#">05.08</a> ).	
	No	No reset.	0
	Reset	Reset the counter.	1
<b>81 Pump protection</b>		Settings for pump protection functions. See also section <a href="#">Protective functions</a> on page 66.	
81.01	Inlet prot ctrl	Enables the primary supervision of pump inlet pressure and selects the action taken when low inlet pressure is detected. The selected action is taken only after the measured pressure has remained below the pressure limit ( <a href="#">81.03 AI in low level</a> ) for longer than the value of parameter <a href="#">81.07 Inlet ctrl dly</a> . The pressure can be measured using an analog pressure sensor or a pressure switch. The input for an analog sensor is defined by parameter <a href="#">81.02 AI measure inlet</a> . With an analog sensor, a separate action for “very low inlet pressure” can be defined using parameter <a href="#">81.05 AI in very low</a> . The input for a pressure switch is defined by parameter <a href="#">81.06 DI status inlet</a> .	
	Not used	Primary inlet pressure supervision not used.	0
	Alarm	Detection of low inlet pressure produces an alarm after the delay defined by parameter <a href="#">81.07 Inlet ctrl dly</a> expires.	1
	Fault	Detection of low inlet pressure trips the drive after the delay defined by parameter <a href="#">81.07 Inlet ctrl dly</a> expires.	2



No.	Name/Value	Description	FbEq
	Protect	Detection of low inlet pressure produces an alarm after the delay defined by parameter <a href="#">81.07 Inlet ctrl dly</a> expires. The pump speed is reduced to the speed defined by <a href="#">81.08 Inlet forced ref</a> .	3
81.02	AI measure inlet	Selects the analog input (or signal source) for pump inlet pressure measurement.	
	AI1 scaled	<a href="#">02.05 AI1 scaled</a> (see page 120).	1073742341
	AI2 scaled	<a href="#">02.07 AI2 scaled</a> (see page 120).	1073742343
	AI3 scaled	<a href="#">02.09 AI3 scaled</a> (see page 120).	1073742345
	AI4 scaled	<a href="#">02.11 AI4 scaled</a> (see page 120).	1073742347
	AI5 scaled	<a href="#">02.13 AI5 scaled</a> (see page 120).	1073742349
	Pointer	Value pointer setting (see <a href="#">Terms and abbreviations</a> on page 115).	-
81.03	AI in low level	Pressure limit for primary inlet pressure supervision. See parameter <a href="#">81.01 Inlet prot ctrl</a> .	
	0.00 ... 32767.00 bar	Pressure limit.	100 = 1 bar

## 290 Parameters

No.	Name/Value	Description	FbEq
81.04	Very low ctrl	Enables the secondary supervision of pump inlet pressure, and selects the action taken after very low inlet pressure is detected. The selected action is taken only after the measured pressure has remained below the pressure limit ( <i>81.05 AI in very low</i> ) for longer than the value of parameter <i>81.07 Inlet ctrl dly</i> . See the diagram at parameter <i>81.01 Inlet prot ctrl</i> . <b>Note:</b> With a pressure switch, this parameter has no effect.	
	Not sel	Secondary inlet pressure supervision not used.	0
	Fault	Detection of very low inlet pressure trips the drive.	1
	Stop	Detection of very low inlet pressure stops the drive. The drive will restart if the pressure rises above the limit.	2
81.05	AI in very low	Pressure limit for secondary inlet pressure supervision. See parameter <i>81.04 Very low ctrl</i> .	
	0.00 ... 32767.00 bar	Pressure limit.	100 = 1 bar
81.06	DI status inlet	Selects the digital input for connection of a pressure switch at the pump inlet. The "normal" state is 1. If the selected input switches to 0, the action defined by parameter <i>81.01 Inlet prot ctrl</i> is taken after the delay set by parameter <i>81.07 Inlet ctrl dly</i> expires.	
	Not used	No pressure switch connected.	1
	DI1	Digital input DI1 (as indicated by <i>02.01 DI status</i> , bit 0).	1073742337
	DI2	Digital input DI2 (as indicated by <i>02.01 DI status</i> , bit 1).	1073807873
	DI3	Digital input DI3 (as indicated by <i>02.01 DI status</i> , bit 2).	1073873409
	DI4	Digital input DI4 (as indicated by <i>02.01 DI status</i> , bit 3).	1073938945
	DI5	Digital input DI5 (as indicated by <i>02.01 DI status</i> , bit 4).	1074004481
	Const Pointer	Bit pointer setting (see <i>Terms and abbreviations</i> on page 115).	-
81.07	Inlet ctrl dly	Delay for primary and secondary supervision of pump inlet pressure. See parameter <i>81.01 Inlet prot ctrl</i> .	
	0...600 s	Delay.	1 = 1 s
81.08	Inlet forced ref	Pump speed reference for parameter <i>81.01 Inlet prot ctrl</i> , selection <i>Protect</i> .	
	0.0 ... 32767.0 rpm	Speed reference.	10 = 1 rpm
81.09	Outlet prot ctrl	Enables the primary supervision of pump outlet pressure and selects the action taken when high outlet pressure is detected. The selected action is taken only after the measured pressure has remained above the pressure limit ( <i>81.11 AI out hi level</i> ) for longer than the value of parameter <i>81.15 Outlet ctr dly</i> . The pressure can be measured using an analog pressure sensor or a pressure switch. The input for an analog sensor is defined by parameter <i>81.10 AI meas outlet</i> . With an analog sensor, a separate action for "very high outlet pressure" can be defined using parameter <i>81.13 AI out very high</i> . The input for a pressure switch is defined by parameter <i>81.14 DI status outlet</i> .	
	Not used	Primary outlet pressure supervision not used.	0

No.	Name/Value	Description	FbEq
	Alarm	Detection of high outlet pressure produces an alarm after the delay defined by parameter <a href="#">81.15 Outlet ctr dly</a> expires.	1
	Fault	Detection of high outlet pressure trips the drive after the delay defined by parameter <a href="#">81.15 Outlet ctr dly</a> expires.	2
	Protect	Detection of high outlet pressure produces an alarm after the delay defined by parameter <a href="#">81.15 Outlet ctr dly</a> expires. The pump speed is reduced to the speed defined by <a href="#">81.16 Outlet force ref</a> within the time defined by parameter <a href="#">81.17 Protect dec time</a> .	3
<p>The diagram consists of five vertically aligned graphs sharing a common time axis:</p> <ul style="list-style-type: none"> <li><b>Measured outlet pressure:</b> Shows a signal that rises from a baseline, crosses the <a href="#">81.11 AI out hi level</a> threshold, and then reaches the <a href="#">81.13 AI out very high</a> threshold. A delay interval <a href="#">81.15 Outlet ctr dly</a> is marked between the first threshold crossing and the second.</li> <li><b>Speed reference:</b> Shows a step function that drops from a high level to a lower level labeled <a href="#">81.16 Outlet force ref</a> when the pressure reaches the <a href="#">81.13 AI out very high</a> level. The ramp-down time is labeled <a href="#">81.17 Protect dec time</a>.</li> <li><b>06.20 Pump status word, bit 15:</b> A digital pulse that becomes high when the pressure reaches the <a href="#">81.13 AI out very high</a> level and returns to low when the pressure falls below the <a href="#">81.11 AI out hi level</a>.</li> <li><b>08.21 Pump alarm word, bit 3:</b> A digital pulse that becomes high when the pressure reaches the <a href="#">81.13 AI out very high</a> level and returns to low when the pressure falls below the <a href="#">81.11 AI out hi level</a>.</li> <li><b>08.21 Pump alarm word, bit 5:</b> A digital pulse that becomes high when the pressure reaches the <a href="#">81.13 AI out very high</a> level and returns to low when the pressure falls below the <a href="#">81.11 AI out hi level</a>.</li> </ul>			
81.10	AI meas outlet	Selects the analog input (or signal source) for pump outlet pressure measurement.	
	AI1 scaled	<a href="#">02.05 AI1 scaled</a> (see page <a href="#">120</a> ).	1073742341
	AI2 scaled	<a href="#">02.07 AI2 scaled</a> (see page <a href="#">120</a> ).	1073742343
	AI3 scaled	<a href="#">02.09 AI3 scaled</a> (see page <a href="#">120</a> ).	1073742345
	AI4 scaled	<a href="#">02.11 AI4 scaled</a> (see page <a href="#">120</a> ).	1073742347
	AI5 scaled	<a href="#">02.13 AI5 scaled</a> (see page <a href="#">120</a> ).	1073742349
	Pointer	Value pointer setting (see <a href="#">Terms and abbreviations</a> on page <a href="#">115</a> ).	-

## 292 Parameters

No.	Name/Value	Description	FbEq
81.11	AI out hi level	Pressure limit for primary outlet pressure supervision. See parameter <a href="#">81.09 Outlet prot ctrl</a> .	
	0.00 ... 32767.00 bar	Pressure limit.	100 = 1 bar
81.12	Very high ctrl	Enables the secondary supervision of pump outlet pressure and selects the action taken when very high outlet pressure is detected. The selected action is taken only after the measured pressure has remained above the pressure limit ( <a href="#">81.13 AI out very high</a> ) for longer than the value of parameter <a href="#">81.15 Outlet ctr dly</a> . See the diagram at parameter <a href="#">81.09 Outlet prot ctrl</a> . <b>Note:</b> With a pressure switch, this parameter has no effect.	
	Not sel	Secondary outlet pressure supervision not used.	0
	Fault	Detection of very high outlet pressure trips the drive.	1
	Stop	Detection of very high outlet pressure stops the drive. The drive will restart if the pressure falls below the limit.	2
81.13	AI out very high	Pressure limit for secondary outlet pressure supervision. See parameter <a href="#">81.12 Very high ctrl</a> .	
	0.00 ... 32767.00 bar	Pressure limit.	100 = 1 bar
81.14	DI status outlet	Selects the digital input for connection of a pressure switch at the pump outlet. The "normal" state is 1. If the selected input switches to 0, the action defined by parameter <a href="#">81.09 Outlet prot ctrl</a> is taken after the delay set by parameter <a href="#">81.15 Outlet ctr dly</a> expires.	
	Not used	No pressure switch connected.	1074070017
	DI1	Digital input DI1 (as indicated by <a href="#">02.01 DI status</a> , bit 0).	1073742337
	DI2	Digital input DI2 (as indicated by <a href="#">02.01 DI status</a> , bit 1).	1073807873
	DI3	Digital input DI3 (as indicated by <a href="#">02.01 DI status</a> , bit 2).	1073873409
	DI4	Digital input DI4 (as indicated by <a href="#">02.01 DI status</a> , bit 3).	1073938945
	DI5	Digital input DI5 (as indicated by <a href="#">02.01 DI status</a> , bit 4).	1074004481
	Const	Bit pointer setting (see <a href="#">Terms and abbreviations</a> on page <a href="#">115</a> ).	-
	Pointer		
81.15	Outlet ctr dly	Delay for primary and secondary supervision of pump outlet pressure. See parameter <a href="#">81.09 Outlet prot ctrl</a> .	
	0...600 s	Delay.	1 = 1 s
81.16	Outlet force ref	Pump speed reference for parameter <a href="#">81.09 Outlet prot ctrl</a> , selection <a href="#">Protect</a> .	
	0.0 ... 32767.0 rpm	Speed reference.	10 = 1 rpm
81.17	Protect dec time	PID controller ramp-down time for parameter <a href="#">81.09 Outlet prot ctrl</a> , selection <a href="#">Protect</a> .	
	0...18000 s	PID controller ramp-down time for outlet pressure supervision.	1 = 1 s
81.18	Flow source sel	Selects an source for flow measurement for minimum/maximum flow protection. See parameters <a href="#">81.19 Flow max prot</a> and <a href="#">81.21 Flow min prot</a> .	
	AI1 scaled	<a href="#">02.05 AI1 scaled</a> (see page <a href="#">120</a> ).	1073742341
	AI2 scaled	<a href="#">02.07 AI2 scaled</a> (see page <a href="#">120</a> ).	1073742343

No.	Name/Value	Description	FbEq
	AI3 scaled	<a href="#">02.09 AI3 scaled</a> (see page 120).	1073742345
	AI4 scaled	<a href="#">02.11 AI4 scaled</a> (see page 120).	1073742347
	AI5 scaled	<a href="#">02.13 AI5 scaled</a> (see page 120).	1073742349
	Flow act	Calculated flow as indicated by <a href="#">05.05 Flow act</a> (see page 131).	1073743109
	Pointer	Value pointer setting (see <a href="#">Terms and abbreviations</a> on page 115).	-
81.19	Flow max prot	Defines the action to be taken if the flow (signal selected by parameter <a href="#">81.18 Flow source sel</a> ) remains above the limit set by parameter <a href="#">81.20 Flow max level</a> for longer than the time set by parameter <a href="#">81.23 Flow ctrl delay</a> .	
	Not sel	Maximum flow protection disabled.	0
	Alarm	The drive generates alarm <a href="#">MAX FLOW</a> .	1
	Fault	The drive trips on fault <a href="#">MAX FLOW</a> .	2
81.20	Flow max level	Defines the maximum flow limit. See parameter <a href="#">81.19 Flow max prot</a> .	
	0.00 ... 32767.00 m <sup>3</sup> /h	Maximum flow.	100 = 1 m <sup>3</sup> /h
81.21	Flow min prot	Defines the action to be taken if the flow (signal selected by parameter <a href="#">81.18 Flow source sel</a> ) remains below the limit set by parameter <a href="#">81.22 Flow min level</a> for longer than the time set by parameter <a href="#">81.23 Flow ctrl delay</a> . See also parameter <a href="#">81.24 Flow check delay</a> .	
	Not sel	Minimum flow protection disabled.	0
	Alarm	The drive generates alarm <a href="#">MIN FLOW</a> .	1
	Fault	The drive trips on fault <a href="#">MIN FLOW</a> .	2
81.22	Flow min level	Defines the minimum flow limit. See parameter <a href="#">81.21 Flow min prot</a> .	
	0.00 ... 32767.00 m <sup>3</sup> /h	Minimum flow.	100 = 1 m <sup>3</sup> /h
81.23	Flow ctrl delay	Specifies a delay for minimum/maximum flow protection. See parameters <a href="#">81.19 Flow max prot</a> and <a href="#">81.21 Flow min prot</a> .	
	0...12600 s	Delay for minimum/maximum flow protection.	1 = 1 s
81.24	Flow check delay	After starting the drive, defines a period during which the minimum flow protection is disabled so that normal flow can be reached.	
	0...12600 s	Start delay for minimum flow protection.	1 = 1 s
81.25	Appl prot ctrl	Enables/disables the Application profile protection function, based on long-term monitoring of an internal signal. If the selected signal exceeds (and remains above) the supervision limit longer than the delay set by parameter <a href="#">81.27 Prof limit dly</a> , the alarm <a href="#">PROFILE HIGH</a> is generated and <a href="#">08.21 Pump alarm word</a> bit 6 set to 1.	
	Not used	Application profile protection disabled.	0
	PID error	Signal <a href="#">04.04 Process PID err</a> compared to value of parameter <a href="#">81.26 Prof limit</a> .	1
	PID out	Signal <a href="#">04.05 Process PID out</a> compared to value of parameter <a href="#">81.26 Prof limit</a> .	2

## 294 Parameters

No.	Name/Value	Description	FbEq
81.26	Prof limit	Supervision limit for the Application profile protection.	
	0.00 ... 32767.00 %	Supervision limit.	100 = 1%
81.27	Prof limit dly	Delay for the Application profile protection.	
	0.00 ... 35791394.11 h	Delay.	100 = 1 h
81.28	Pipefill enable	Enables/disables (or selects a signal source that enables/disables) the Pipefill function when the drive is started. 1 = Enable Pipefill function. If the signal is removed before Pipefill is completed, Pipefill is aborted and normal PID control enabled.	
	Not used	Pipefill function disabled.	0
	Active	Pipefill function enabled.	1
	DI1	The status of digital input DI1 (as indicated by <a href="#">02.01 DI status</a> , bit 0) determines whether the Pipefill function is enabled or disabled.	1073742337
	DI2	The status of digital input DI2 (as indicated by <a href="#">02.01 DI status</a> , bit 1) determines whether the Pipefill function is enabled or disabled.	1073807873
	DI3	The status of digital input DI3 (as indicated by <a href="#">02.01 DI status</a> , bit 2) determines whether the Pipefill function is enabled or disabled.	1073873409
	DI4	The status of digital input DI4 (as indicated by <a href="#">02.01 DI status</a> , bit 3) determines whether the Pipefill function is enabled or disabled.	1073938945
	DI5	The status of digital input DI5 (as indicated by <a href="#">02.01 DI status</a> , bit 4) determines whether the Pipefill function is enabled or disabled.	1074004481
	Const	Bit pointer setting (see <a href="#">Terms and abbreviations</a> on page 115).	-
	Pointer		
81.29	Pipefill step	Defines the speed step used for the Pipefill function, as well as the pump speed reference immediately after the Pipefill function is activated. The speed step is added to the reference after the time defined by parameter <a href="#">81.31 Act change delay</a> has elapsed and the change in process actual value defined by parameter <a href="#">81.30 Req act change</a> has not been reached. The PID controller reference ramp time is specified by parameter <a href="#">27.32 Pipefill ref acc</a> .	
	0...32767 rpm	Speed step for the Pipefill function.	1 = 1 rpm
81.30	Req act change	Defines the requested change in process actual value within the time set by parameter <a href="#">81.31 Act change delay</a> .	
	0.00 ... 100.00%	Requested change.	100 = 1%
81.31	Act change delay	Defines the time that is waited after the process actual value is compared to the previous actual value. If parameter <a href="#">81.30 Req act change</a> is measured in the actual value, the speed reference stays as it is. If <a href="#">81.30 Req act change</a> is not seen in the actual value, the value of parameter <a href="#">81.29 Pipefill step</a> is added to the speed reference.	
	0...100 s	Delay for actual value change.	1 = 1 s

No.	Name/Value	Description	FbEq
81.32	Pid enable dev	Defines the process actual value level at which the Pipefill function is disabled and normal PID control is enabled. After the level is reached, the time defined by parameter <a href="#">81.33 Pid enb dev dly</a> is allowed to pass before normal PID control is enabled. PID reference ramps are then observed (if set). The value is given in percent of the maximum process actual value.	
	0.00 ... 100.00%	Pipefill / PID control breakpoint.	100 = 1%
81.33	Pid enb dev dly	Delay for enabling PID control. See parameter <a href="#">81.32 Pid enable dev</a> .	
	0...12600 s	PID enable delay.	1 = 1 s
81.34	Pipefill timeout	Defines the maximum allowed time for the Pipefill function. If the target process actual value (parameter <a href="#">81.32 Pid enable dev</a> ) is not reached within this time, the action defined by parameter <a href="#">81.35 Pipefill fit ctr</a> is taken.	
	0...12600 s	Maximum Pipefill time.	1 = 1 s
81.35	Pipefill fit ctr	Defines the action for the Pipefill timeout (parameter <a href="#">81.34 Pipefill timeout</a> ).	
	Alarm	The drive generates alarm <a href="#">PIPEFILL TIMEOUT</a> .	0
	Fault	The drive trips on fault <a href="#">PIPEFILL TOUT</a> .	1
	Activate PID	Normal PID control is enabled.	2

No.	Name/Value	Description	FbEq
-----	------------	-------------	------

<b>82 Pump cleaning</b>		Settings for the pump cleaning sequence. See also section <a href="#">Pump cleaning</a> on page 66.	
-------------------------	--	--	--

82.01	Pump clean trig	<p>Enables the pump cleaning sequence for the drive, and defines the triggering conditions.</p> <p> <b>WARNING!</b> Before enabling the pump cleaning sequence, make sure that it can be performed safely with the connected equipment.</p> <p><b>Notes:</b></p> <ul style="list-style-type: none"> <li>• By default, the cleaning sequence is started in the forward direction, but it can also be started in the reverse direction. See bit 7.</li> <li>• Multiple triggering conditions can exist simultaneously.</li> <li>• For the load curve triggering conditions (bit 8 and 9) to work, the <a href="#">LOAD CURVE (0x2312)</a> fault must be disabled by parameters <a href="#">34.01 Overload func</a> and <a href="#">34.02 Underload func</a>.</li> <li>• The cleaning sequence observes the speed limits defined by parameters <a href="#">20.01 Maximum speed</a> and <a href="#">20.02 Minimum speed</a>.</li> <li>• The drive must be started and its run enable signal present before the cleaning sequence can be started.</li> </ul>	
-------	-----------------	--	--

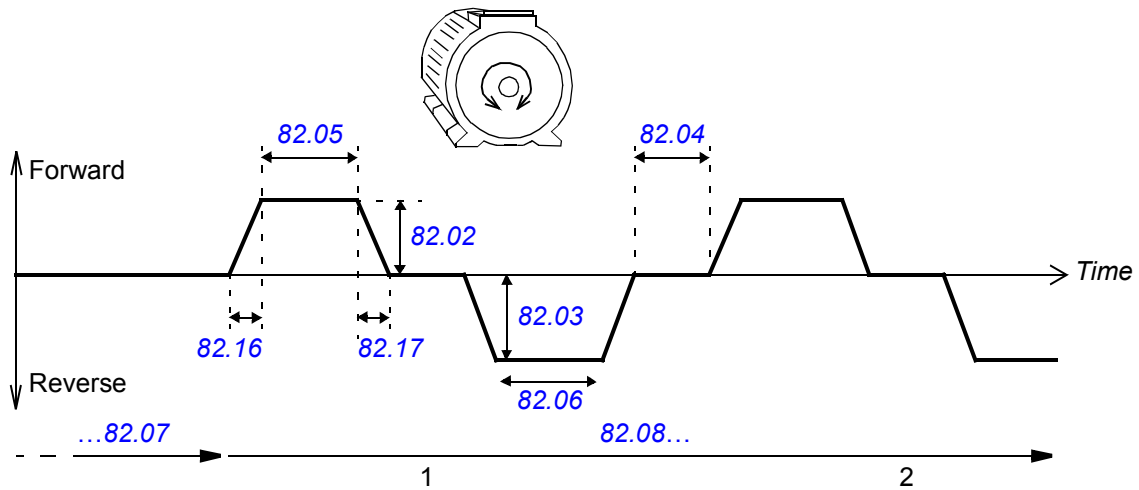



No.	Name/Value	Description	FbEq
	<b>Bit</b>	<b>Name</b>	<b>Function</b>
	0	Enabled	0 = No: Cleaning sequence disabled. 1 = Yes: Cleaning sequence enabled.
	1	Master enb	0 = No: Cleaning sequence not allowed when the drive is master. 1 = Yes: Cleaning sequence allowed when the drive is master.
	2	Follower enb	0 = No: Cleaning sequence not allowed when the drive is a follower. 1 = Yes: Cleaning sequence allowed when the drive is a follower.
	3	Time trig	1 = Enable: Cleaning sequence starts periodically at intervals defined by parameter <a href="#">82.07 Time trig</a> .
	4	Supervision	1 = Enable: Cleaning sequence is started whenever the signal selected by parameter <a href="#">82.09 Supervis source</a> exceeds the value of parameter <a href="#">82.10 Supervis limit</a> .
	5	At start	1 = Enable: Cleaning sequence performed on every start command.
	6	Trig ptr	1 = Enable: Cleaning sequence is performed when the signal selected by parameter <a href="#">82.12 Trig pointer</a> changes to 1.
	7	Neg direction	1 = Enable: Cleaning sequence reference is inverted. The first step is in the reverse direction, the second step in the forward direction.
	8	Underload	1 = Enable: Cleaning sequence is started when the underload limit defined by parameter <a href="#">34.02 Underload func</a> is exceeded.
	9	Overload	1 = Enable: Cleaning sequence is started when the underload limit defined by parameter <a href="#">34.01 Overload func</a> is exceeded.
82.02	First Step	First step frequency for the cleaning sequence in percent of the value of parameter <a href="#">19.01 Speed scaling</a> .	
	0.0 ... 100.0%	First step frequency.	10 = 1%
82.03	Second Step	Second step frequency for the cleaning sequence in percent of the value of parameter <a href="#">19.01 Speed scaling</a> .	
	0.0 ... 100.0%	Second step frequency.	10 = 1%
82.04	Off time	Interval between forward and reverse steps during the cleaning sequence.	
	0...1000 s	Interval between steps.	1 = 1 s
82.05	First Step Time	Duration of the first step during the cleaning sequence, and of the rest of the steps which are run in the same direction.	
	0...1000 s	Duration of the first step and the rest of the steps which are run in the same direction.	1 = 1 s
82.06	Second Step Time	Duration of the second step during the cleaning sequence and of the rest of the steps which are run in the same direction.	
	0...1000 s	Duration of the second step and the rest of the steps which are run in the same direction.	1 = 1 s
82.07	Time trig	Time between periodical cleaning sequences. See parameter <a href="#">82.01 Pump clean trig</a> , bit 3.	
	0.00 ... 35791394.11 h	Time between cleaning sequences.	1 = 1 min
82.08	Nbr of steps	Number of forward-reverse step combinations to be performed during the cleaning sequence.	
	0...2147483647	Number of steps.	1 = 1

No.	Name/Value	Description	FbEq
82.09	Supervis source	Defines a signal that triggers the cleaning sequence when it remains above the limit defined by parameter <a href="#">82.10 Supervis limit</a> for longer than the time set by parameter <a href="#">82.11 Cleaning delay</a> . See also parameter <a href="#">82.01 Pump clean trig</a> , bit 4.	
	Current A	<a href="#">01.04 Motor current</a> (see page 118).	1073742084
	Current %	<a href="#">01.05 Motor current %</a> (see page 118).	1073742085
	Motor torque	<a href="#">01.06 Motor torque</a> (see page 118).	1073742086
	Pointer	Value pointer setting (see <a href="#">Terms and abbreviations</a> on page 115).	-
82.10	Supervis limit	Defines a limit for the signal selected by parameter <a href="#">82.09 Supervis source</a> .	
	0.0 ... 32767.0	Cleaning sequence triggering limit.	10 = 1
82.11	Cleaning delay	Defines a delay for triggering the cleaning sequence. This delay is added to the triggering conditions selectable by bits 4, 6, 8 and 9 in parameter <a href="#">82.01 Pump clean trig</a> . <b>Note:</b> When the load curve (bits 8 and 9) is used as the triggering condition, the delay is recommended to prevent unnecessary recurrent cleaning sequences.	
	0...600 s	Cleaning sequence triggering delay.	1 = 1 s
82.12	Trig pointer	Cleaning sequence trigger input selection. See parameter <a href="#">82.01 Pump clean trig</a> , bit 6.	
	Not used	No input selected.	0
	DI1	Digital input DI1 (as indicated by <a href="#">02.01 DI status</a> , bit 0).	1073742337
	DI2	Digital input DI2 (as indicated by <a href="#">02.01 DI status</a> , bit 1).	1073807873
	DI3	Digital input DI3 (as indicated by <a href="#">02.01 DI status</a> , bit 2).	1073873409
	DI4	Digital input DI4 (as indicated by <a href="#">02.01 DI status</a> , bit 3).	1073938945
	DI5	Digital input DI5 (as indicated by <a href="#">02.01 DI status</a> , bit 4).	1074004481
	Const	Bit pointer setting (see <a href="#">Terms and abbreviations</a> on page 115).	-
	Pointer		
82.13	Clean max ctrl	Defines the action taken if the maximum number of cleaning sequences ( <a href="#">82.14 Clean max number</a> ) is exceeded within the time set by parameter <a href="#">82.15 Clean max period</a> .	
	Not sel	No action taken.	0
	Alarm	The drive generates an alarm, <a href="#">MAX CLEANINGS</a> .	1
	Fault	The drive trips on fault <a href="#">MAX CLEANINGS</a> .	2
82.14	Clean max number	Defines the maximum number of cleaning sequences within the time set by parameter <a href="#">82.15 Clean max period</a> .	
	0...30	Maximum number of cleaning sequences.	1 = 1
82.15	Clean max period	Defines the time (ending now) within which cleaning sequences are counted.	
	0.00 ... 35791394.11 h	Time within which cleaning sequences are counted.	100 = 1 h
82.16	Clean step acc	Defines the acceleration time from 0 rpm to the step frequency (parameters <a href="#">82.02 First Step</a> and <a href="#">82.03 Second Step</a> ).	
	0...32767 s	Step acceleration time.	1 = 1 s

No.	Name/Value	Description	FbEq
82.17	Clean step dec	Defines the deceleration time from the step frequency (parameters <a href="#">82.02 First Step</a> and <a href="#">82.03 Second Step</a> ) to 0 rpm.	
	0...32767 s	Step deceleration time.	1 = 1 s
<b>83 Energy monitoring</b>		Energy consumption monitoring settings. See also section <a href="#">Energy consumption monitoring</a> on page <a href="#">86</a> .	
83.01	Energy mon mode	Enables/disables, and selects the mode of, consumed energy monitoring. Whenever the consumption within the current period exceeds the selected reference by a predefined margin (or tolerance), the drive takes the action defined by parameter <a href="#">83.05 Energy mon ctrl</a> .	
	Not used	Energy monitoring not in use.	0
	Limits	The current energy monitoring period is compared to the consumption limit set by parameter <a href="#">83.03 kWh limit</a> .	1
	Previous	The current energy monitoring period (parameter <a href="#">05.20 kWh current read</a> ) is compared to the previous period ( <a href="#">05.21 kWh prev read</a> ).	2
	Average	The current energy monitoring period (parameter <a href="#">05.20 kWh current read</a> ) is compared to the average of the two previous periods ( <a href="#">05.21 kWh prev read</a> and <a href="#">05.22 kWh posprev read</a> ).	3
83.02	Mon period	Defines the length of an energy monitoring period. The first period starts when the drive is powered up.	
	0.00 ... 35791394.11 h	Length of monitoring period.	1 = 1 min
83.03	kWh limit	Consumed energy limit for parameter <a href="#">83.01 Energy mon mode</a> , selection <a href="#">Limits</a> .	
	0...2147483647 kWh	Energy limit.	1 = 1 kWh
83.04	Mon tolerance	Tolerance for energy limit. The energy consumption may exceed the reference energy by this tolerance value until the action defined by parameter <a href="#">83.05 Energy mon ctrl</a> is taken.	
	0...2147483647 kWh	Tolerance.	1 = 1 kWh
83.05	Energy mon ctrl	Defines the action that is taken if the energy consumption exceeds the tolerance limits.	
	Not sel	No action taken.	0
	Alarm	The drive generates alarm <a href="#">ENERGY LIMIT</a> .	1
83.06	Energy reset	Resets the energy monitoring counters.	
	No	No reset. The parameter automatically reverts to this value after a reset.	0
	Period	Resets the periodic energy counters (parameters <a href="#">05.20...05.22</a> ).	1
	Month	Resets the monthly energy counters (parameters <a href="#">05.23...05.35</a> ).	2
83.07	Date alarm ctrl	Defines the action that is taken if the date has not been set.	
	Not sel	No action taken.	0
	Alarm	The drive generates alarm <a href="#">DATE WRONG</a> .	1

## 300 Parameters

No.	Name/Value	Description	FbEq
<b>94 Ext IO conf</b>		I/O extension configuration. See also section <a href="#">Programmable I/O extensions</a> on page 71.	
94.01	Ext IO1 sel	Activates an I/O extension installed into Slot 1.	
	None	No extension installed into Slot 1.	0
	FIO-01	FIO-01 extension installed into Slot 1. Additional 4 × DIO and 2 × RO are in use.	1
	FIO-11	FIO-11 extension installed into Slot 1. Additional 2 × DIO, 3 × AI and 1 × AO are in use.	2
	FIO-21	FIO-21 extension installed into Slot 1. Additional 1 × DI, 1 × AI and 2 × RO are in use.	3
	FIO-31	FIO-31 extension installed into Slot 1. Additional 4 × RO are in use.	4
<b>95 Hw configuration</b>		Diverse hardware-related settings.	
95.01	Ctrl boardSupply	Selects how the drive control unit is powered.	
	Internal 24V	The drive control unit is powered from the drive power unit it is mounted on. This is the default setting.	0
	External 24V	The drive control unit is powered from an external power supply.	1
95.03	Temp inu ambient	Defines the maximum ambient temperature. This temperature is used to calculate the estimated drive temperature. If the measured drive temperature exceeds the estimated value, an alarm ( <a href="#">COOLING</a> ) or fault ( <a href="#">COOLING</a> ) is generated.	
	0...55 °C	Drive ambient temperature.	1 = 1 °C
<b>97 User motor par</b>		Motor values supplied by the user that are used in the motor model.	
97.01	Use given params	Activates the motor model parameters <a href="#">97.02...97.12</a> . Notes: Parameter value is automatically set to zero when ID run is selected by parameter <a href="#">99.13 IDrun mode</a> . The values of parameters <a href="#">97.02...97.12</a> are updated according to the motor characteristics identified during the ID run. This parameter cannot be changed while the drive is running.	
	NoUserPars	Parameters <a href="#">97.02...97.12</a> inactive.	0
	UserMotPars	The values of parameters <a href="#">97.02...97.12</a> are used in the motor model.	1
	UserPosOffs	Reserved.	2
	AllUserPars	Reserved.	3
97.02	Rs user	Defines the stator resistance $R_S$ of the motor model.	
	0.00000 ... 0.50000 p.u.	Stator resistance in per unit.	100000 = 1 p.u.
97.03	Rr user	Defines the rotor resistance $R_R$ of the motor model.	
	0.00000 ... 0.50000 p.u.	Rotor resistance in per unit.	100000 = 1 p.u.



No.	Name/Value	Description	FbEq
97.04	Lm user	Defines the main inductance $L_M$ of the motor model.	
	0.00000 ... 10.00000 p.u.	Main inductance in per unit.	100000 = 1 p.u.
97.05	SigmaL user	Defines the leakage inductance $\sigma L_S$ .	
	0.00000 ... 1.00000 p.u.	Leakage inductance in per unit.	100000 = 1 p.u.
97.06	Ld user	Defines the direct axis (synchronous) inductance.	
	0.00000 ... 10.00000 p.u	Direct axis inductance in per unit.	100000 = 1 p.u.
97.07	Lq user	Defines the quadrature axis (synchronous) inductance.	
	0.00000 ... 10.00000 p.u	Quadrature axis inductance in per unit.	100000 = 1 p.u.
97.08	Pm flux user	Defines the permanent magnet flux.	
	0.00000 ... 2.00000 p.u	Permanent magnet flux in per unit.	100000 = 1 p.u.
97.09	Rs user SI	Defines the stator resistance $R_S$ of the motor model.	
	0.00000 ... 100.00000 ohm	Stator resistance.	100000 = 1 ohm
97.10	Rr user SI	Defines the rotor resistance $R_R$ of the motor model.	
	0.00000 ... 100.00000 ohm	Rotor resistance.	100000 = 1 ohm
97.11	Lm user SI	Defines the main inductance $L_M$ of the motor model.	
	0.00 ... 100000.00 mH	Main inductance.	100 = 1 mH
97.12	SigL user SI	Defines the leakage inductance $\sigma L_S$ .	
	0.00 ... 100000.00 mH	Leakage inductance.	100 = 1 mH
97.13	Ld user SI	Defines the direct axis (synchronous) inductance.	
	0.00 ... 100000.00 mH	Direct axis inductance.	100 = 1 mH
97.14	Lq user SI	Defines the quadrature axis (synchronous) inductance.	
	0.00 ... 100000.00 mH	Quadrature axis inductance.	100 = 1 mH
<b>99 Start-up data</b>		Language selection, motor configuration and ID run settings.	
99.01	Language	Selects the language of the control panel displays. <b>Note:</b> Not all languages listed below are necessarily supported.	
	English	English.	0809
	Deutsch	German.	0407
	Italiano	Italian.	0410
	Espanol	Spanish.	040A
	Nederlands	Dutch.	0413
	Francais	French.	040C
	Dansk	Danish.	0406
	Svenska	Swedish.	041D

No.	Name/Value	Description	FbEq
	Ruski	Russian.	0419
	Polski	Polish.	0415
	Turkce	Turkish.	041F
	Magyar	Hungarian.	040E
	Chinese	Chinese.	0804
99.04	Motor type	Selects the motor type. <b>Note:</b> This parameter cannot be changed while the drive is running.	
	AM	Asynchronous motor. Three-phase AC induction motor with squirrel cage rotor.	0
	SynRM	Synchronous reluctance motor. Three-phase AC synchronous motor with salient pole rotor without permanent magnets. Only visible with option +N7502.	2
99.05	Motor ctrl mode	Selects the motor control mode.	
	DTC	Direct torque control. This mode is suitable for most applications. <b>Note:</b> Instead of direct torque control, use scalar control <ul style="list-style-type: none"> <li>• with multimotor applications 1) if the load is not equally shared between the motors, 2) if the motors are of different sizes, or 3) if the motors are going to be changed after the motor identification (ID run),</li> <li>• if the nominal current of the motor is less than 1/6 of the nominal output current of the drive,</li> <li>• if the drive is used with no motor connected (for example, for test purposes),</li> <li>• if the drive runs a medium-voltage motor through a step-up transformer.</li> </ul>	0
	Scalar	Scalar control. This mode is suitable in special cases where DTC cannot be applied. In scalar control, the drive is controlled with a frequency reference. The outstanding motor control accuracy of DTC cannot be achieved in scalar control. Some standard features are disabled in scalar control mode. <b>Note:</b> Correct motor run requires that the magnetizing current of the motor does not exceed 90% of the nominal current of the inverter. See also section <a href="#">Scalar motor control</a> on page 75.	1
99.06	Mot nom current	Defines the nominal motor current. Must be equal to the value on the motor rating plate. If multiple motors are connected to the drive, enter the total current of the motors. <b>Notes:</b> <ul style="list-style-type: none"> <li>• Correct motor run requires that the magnetizing current of the motor does not exceed 90% of the nominal current of the drive.</li> <li>• This parameter cannot be changed while the drive is running.</li> </ul>	
	0.0 ... 6400.0 A	Nominal current of the motor. The allowable range is 1/6...2 · I <sub>2N</sub> of the drive (0...2 · I <sub>2N</sub> with scalar control mode).	10 = 1 A

No.	Name/Value	Description	FbEq
99.07	Mot nom voltage	<p>Defines the nominal motor voltage as fundamental phase-to-phase rms voltage supplied to the motor at the nominal operating point. This setting must match the value on the rating plate of the motor.</p> <p><b>Notes:</b></p> <ul style="list-style-type: none"> <li>The stress on the motor insulation is always dependent on the drive supply voltage. This also applies to the case where the motor voltage rating is lower than that of the drive and the supply.</li> <li>This parameter cannot be changed while the drive is running.</li> </ul>	
	$1/6 \dots 2 \times U_N$	Nominal voltage of the motor.	10 = 1 V
99.08	Mot nom freq	<p>Defines the nominal motor frequency.</p> <p><b>Note:</b> This parameter cannot be changed while the drive is running.</p>	
	5.0 ... 500.0 Hz	Nominal frequency of the motor.	10 = 1 Hz
99.09	Mot nom speed	<p>Defines the nominal motor speed. The setting must match the value on the rating plate of the motor.</p> <p><b>Notes:</b></p> <ul style="list-style-type: none"> <li>For safety reasons, after ID run, the maximum and minimum speed limits (parameters <a href="#">20.01</a> and <a href="#">20.02</a>) are automatically set to 1.2 times the value of this parameter.</li> <li>This parameter cannot be changed while the drive is running.</li> </ul>	
	0 ... 30000 rpm	Nominal speed of the motor.	1 = 1 rpm
99.10	Mot nom power	<p>Defines the nominal motor power. The setting must match the value on the rating plate of the motor. If multiple motors are connected to the drive, enter the total power of the motors.</p> <p>The unit is selected by parameter <a href="#">16.17 Power unit</a>.</p> <p><b>Note:</b> This parameter cannot be changed while the drive is running.</p>	
	0.00 ... 10000.00 kW	Nominal power of the motor.	100 = 1 kW
99.11	Mot nom cosφ	<p>Defines the cosφ of the motor for a more accurate motor model. Not obligatory; if set, should match the value on the rating plate of the motor.</p> <p><b>Note:</b> This parameter cannot be changed while the drive is running.</p>	
	0.00 ... 1.00	Cosφ of the motor.	100 = 1
99.12	Mot nom torque	<p>Defines the nominal motor shaft torque for a more accurate motor model. Not obligatory.</p> <p><b>Note:</b> This parameter cannot be changed while the drive is running.</p>	
	0 ... 2147483.647 Nm	Nominal motor torque.	1000 = 1 N•m

No.	Name/Value	Description	FbEq
99.13	IDrun mode	<p>Selects the type of the motor identification performed at the next start of the drive (for Direct Torque Control). During the identification, the drive will identify the characteristics of the motor for optimum motor control. After the ID run, the drive is stopped. <b>Note:</b> This parameter cannot be changed while the drive is running.</p> <p>Once the ID run is activated, it can be cancelled by stopping the drive: If ID run has already been performed once, parameter is automatically set to NO. If no ID run has been performed yet, parameter is automatically set to <i>Standstill</i>. In this case, the ID run must be performed.</p> <p><b>Notes:</b></p> <ul style="list-style-type: none"> <li>• ID run can only be performed in local control (i.e. when drive is controlled via PC tool or control panel).</li> <li>• ID run cannot be performed if parameter <i>99.05 Motor ctrl mode</i> is set to <i>Scalar</i>.</li> <li>• Once the ID run is activated, it can be canceled by stopping the drive.</li> <li>• ID run must be performed every time any of the motor parameters (<i>99.06...99.12</i>) have been changed. Parameter is automatically set to <i>Standstill</i> after the motor parameters have been set.</li> <li>• Ensure that the Safe torque off and emergency stop circuits (if any) are closed during the ID run.</li> <li>• After the ID run, the drive maximum and minimum speeds are automatically set to <math>1.2 \cdot 99.09 \text{ Mot nom speed}</math>.</li> </ul>	
	No	No motor ID run is requested. This mode can be selected only if the ID run (Normal/Reduced/Standstill) has already been performed once.	0
	Normal	<p>Normal ID run. Guarantees the best possible control accuracy. The ID run takes about 90 seconds. This mode should be selected whenever it is possible.</p> <p><b>Notes:</b></p> <ul style="list-style-type: none"> <li>• The driven machinery must be de-coupled from the motor with Normal ID run, if the load torque is higher than 20%, or if the machinery is not able to withstand the nominal torque transient during the ID run.</li> <li>• Check the direction of rotation of the motor before starting the ID run. During the run, the motor will rotate in the forward direction.</li> </ul> <p> <b>WARNING!</b> The motor will run at up to approximately 50...100% of the nominal speed during the ID run. ENSURE THAT IT IS SAFE TO RUN THE MOTOR BEFORE PERFORMING THE ID RUN!</p>	1



No.	Name/Value	Description	FbEq
	Reduced	<p>Reduced ID Run. This mode should be selected instead of the Normal ID Run if</p> <ul style="list-style-type: none"> <li>• mechanical losses are higher than 20% (i.e. the motor cannot be de-coupled from the driven equipment), or if</li> <li>• flux reduction is not allowed while the motor is running (i.e. in case of a motor with an integrated brake supplied from the motor terminals).</li> </ul> <p>With Reduced ID run, the control in the field weakening area or at high torques is not necessarily as accurate as with the Normal ID run. Reduced ID run is completed faster than the Normal ID Run (&lt; 90 seconds).</p> <p><b>Note:</b> Check the direction of rotation of the motor before starting the ID run. During the run, the motor will rotate in the forward direction.</p> <p> <b>WARNING!</b> The motor will run at up to approximately 50...100% of the nominal speed during the ID run. ENSURE THAT IT IS SAFE TO RUN THE MOTOR BEFORE PERFORMING THE ID RUN!</p>	2
	Standstill	<p>Standstill ID run. The motor is injected with DC current. The motor shaft will not rotate.</p> <p><b>Note:</b> A standstill ID run should be selected only if the <i>Normal</i>, <i>Reduced</i> or <i>Advanced</i> ID run is not possible due to the restrictions caused by the connected mechanics. See also selection <i>Adv standst.</i></p>	3
		Reserved.	4
	Cur meas cal	Current offset and gain measurement calibration. The calibration will be performed at next start.	5
	Advanced	<p>Advanced ID run. Guarantees the best possible control accuracy. The ID run can take a couple of minutes. This mode should be selected when top performance is needed across the whole operating area.</p> <p><b>Note:</b> The driven machinery must be de-coupled from the motor because of high torque and speed transients that are applied.</p> <p> <b>WARNING!</b> The motor may run at up to the maximum (positive) and minimum (negative) allowed speed during the ID run. Several accelerations and decelerations are done. The maximum torque, current and speed allowed by the limit parameters may be utilized. ENSURE THAT IT IS SAFE TO RUN THE MOTOR BEFORE PERFORMING THE ID RUN!</p>	6
	Adv standst.	<p>Advanced Standstill ID run.</p> <p>This selection is recommended with AC induction motors up to 75 kW instead of the <i>Standstill</i> ID run if</p> <ul style="list-style-type: none"> <li>• the exact nominal ratings of the motor are not known, or</li> <li>• the control performance of the motor is not satisfactory after a <i>Standstill</i> ID run.</li> </ul> <p><b>Note:</b> The time it takes for the Advanced Standstill ID run to complete varies according to motor size. With a small motor, the ID run typically completes within 5 minutes; with a large motor, the ID run may take up to an hour.</p>	7

## 306 Parameters

No.	Name/Value	Description	FbEq
99.16	Phase inversion	Switches the rotation direction of the motor. This parameter can be used if the motor turns to the wrong direction (for example, because of a wrong phase order in the motor cable), and correcting the cabling is considered impractical.	
	No	Normal.	0
	Yes	Reversed rotation direction.	1

---



# Additional parameter data

---

## What this chapter contains

This chapter lists the parameters with some additional data. For parameter descriptions, see chapter [Parameters](#) on page 115.

## Terms and abbreviations

Term	Definition
Actual signal	Signal measured or calculated by the drive. Can usually only be monitored but not adjusted; some counters can however be reset by entering a 0.
Bit pointer	Bit pointer. A bit pointer can point to a single bit in the value of another parameter, or be fixed to 0 (C.FALSE) or 1 (C.TRUE).
enum	Enumerated list, i.e. selection list.
FbEq	Fieldbus equivalent: The scaling between the value shown on the panel and the integer used in serial communication.
INT32	32-bit integer value (31 bits + sign).
No.	Parameter number.
Pb	Packed boolean.
REAL	$\underbrace{\text{16-bit value}} \quad \underbrace{\text{16-bit value}} \quad (31 \text{ bits} + \text{sign})$ = integer value      = fractional value
REAL24	$\underbrace{\text{8-bit value}} \quad \underbrace{\text{24-bit value}} \quad (31 \text{ bits} + \text{sign})$ = integer value      = fractional value

---

Type	Data type. See enum, INT32, Bit pointer, Val pointer, Pb, REAL, REAL24, UINT32.
UINT32	32-bit unsigned integer value.
Val pointer	Value pointer. Points to the value of another parameter.

## Fieldbus addresses

Refer to the *User's Manual* of the fieldbus adapter.

## Pointer parameter format in fieldbus communication

Value and bit pointer parameters are transferred between the fieldbus adapter and drive as 32-bit integer values.

### ■ 32-bit integer value pointers

When a value pointer parameter is connected to the value of another parameter, the format is as follows:

	Bit			
	30...31	16...29	8...15	0...7
<b>Name</b>	Source type	Not in use	Group	Index
<b>Value</b>	1	-	1...255	1...255
<b>Description</b>	Value pointer is connected to parameter	-	Group of source parameter	Index of source parameter

For example, the value that should be written into parameter *33.02 Superv1 act* to change its value to *01.07 Dc-voltage* is  
 0100 0000 0000 0000 0000 0001 0000 0111 = 1073742087 (32-bit integer).

When a value pointer parameter is connected to an application program, the format is as follows:

	Bit		
	30...31	24...29	0...23
<b>Name</b>	Source type	Not in use	Address
<b>Value</b>	2	-	0 ... $2^{24}-1$
<b>Description</b>	Value pointer is connected to application program.	-	Relative address of application program variable

**Note:** Value pointer parameters connected to an application program are read-only via fieldbus.

## ■ 32-bit integer bit pointers

When a bit pointer parameter is connected to value 0 or 1, the format is as follows:

	Bit		
	30...31	1...29	0
<b>Name</b>	Source type	Not in use	Value
<b>Value</b>	0	-	0...1
<b>Description</b>	Bit pointer is connected to 0/1.	-	0 = False, 1 = True

When a bit pointer parameter is connected to a bit value of another parameter, the format is as follows:

	Bit				
	30...31	24...29	16...23	8...15	0...7
<b>Name</b>	Source type	Not in use	Bit sel	Group	Index
<b>Value</b>	1	-	0...31	2...255	1...255
<b>Description</b>	Bit pointer is connected to signal bit value.	-	Bit selection	Group of source parameter	Index of source parameter

When a bit pointer parameter is connected to an application program, the format is as follows:

	Bit		
	30...31	24...29	0...23
<b>Name</b>	Source type	Bit sel	Address
<b>Value</b>	2	0...31	0 ... $2^{24}-1$
<b>Description</b>	Bit pointer is connected to application program.	Bit selection	Relative address of application program variable

**Note:** Bit pointer parameters connected to an application program are read-only via fieldbus.

## Parameter groups 1...9

No.	Name	Type	Data length	Range	Unit	Update time	Notes
<b>01 Actual values</b>							
01.01	Motor speed rpm	REAL	32	-30000...30000	rpm	250 µs	
01.02	Motor speed %	REAL	32	-1000...1000	%	2 ms	
01.03	Output frequency	REAL	32	-30000...30000	Hz	2 ms	
01.04	Motor current	REAL	32	0...30000	A	10 ms	
01.05	Motor current %	REAL	16	0...1000	%	2 ms	
01.06	Motor torque	REAL	16	-1600...1600	%	2 ms	
01.07	Dc-voltage	REAL	32	0...2000	V	2 ms	
01.14	Motor speed est	REAL	32	-30000...30000	rpm	2 ms	
01.15	Temp inverter	REAL24	16	-40...160	%	2 ms	
01.17	Motor temp1	REAL	16	-10...250	°C	10 ms	
01.18	Motor temp2	REAL	16	-10...250	°C	10 ms	
01.19	Used supply volt	REAL	16	0...1000	V	10 ms	
01.21	Cpu usage	UINT32	16	0...100	%	-	
01.22	Power inu out	REAL	32	-32768...32768	kW or hp	10 ms	
01.23	Motor power	REAL	32	-32768...32768	kW or hp	2 ms	
01.24	kWh inverter	INT32	32	0...2147483647	kWh	10 ms	
01.25	kWh supply	INT32	32	-2147483647 ... 2147483647	kWh	10 ms	
01.26	On-time counter	INT32	32	0...35791394.1	h	10 ms	
01.27	Run-time counter	INT32	32	0...35791394.1	h	10 ms	
01.28	Fan on-time	INT32	32	0...35791394.1	h	10 ms	
01.29	Torq nom scale	INT32	32	0...2147483.647	Nm	-	
01.30	Polepairs	INT32	16	0...1000	-	-	
01.31	Mech time const	REAL	32	0...32767	s	10 ms	
01.32	Temp phase A	REAL24	16	-40...160	%	2 ms	
01.33	Temp phase B	REAL24	16	-40...160	%	2 ms	
01.34	Temp phase C	REAL24	16	-40...160	%	2 ms	
01.35	Saved energy	INT32	32	0...2147483647	kWh	10 ms	
01.36	Saved amount	INT32	32	0...21474836.47	-	10 ms	
01.37	Saved CO2	INT32	32	0...214748364.7	t	10 ms	
01.38	Temp int board	REAL24	16	-40...160	°C	2 ms	
01.39	Output voltage	REAL	16	0...1000	V	10 ms	
01.40	Speed filt	REAL	32	-30000...30000	rpm	2 ms	
01.41	Torque filt	REAL	16	-1600...1600	%	2 ms	
01.42	Fan start count	INT32	32	0...2147483647	-	10 ms	
<b>02 I/O values</b>							
02.01	DI status	Pb	16	0b000000...0b111111	-	2 ms	
02.02	RO status	Pb	16	0b000000...0b111111	-	2 ms	
02.03	DIO status	Pb	16	0b0000000000 ... 0b1111111111	-	2 ms	
02.04	AI1	REAL	16	-11...11 V or -22...22 mA	V or mA	2 ms	
02.05	AI1 scaled	REAL	32	-32768...32768	-	2 ms	
02.06	AI2	REAL	16	-11...11 V or -22...22 mA	V or mA	2 ms	
02.07	AI2 scaled	REAL	32	-32768...32768	-	2 ms	
02.08	AI3	REAL	16	-22...22	mA	2 ms	
02.09	AI3 scaled	REAL	32	-32768...32768	-	2 ms	

No.	Name	Type	Data length	Range	Unit	Update time	Notes
02.10	<i>AI4</i>	REAL	16	-22...22	mA	2 ms	
02.11	<i>AI4 scaled</i>	REAL	32	-32768...32768	-	2 ms	
02.12	<i>AI5</i>	REAL	16	-22...22	mA	2 ms	
02.13	<i>AI5 scaled</i>	REAL	32	-32768...32768	-	2 ms	
02.16	<i>AO1</i>	REAL	16	0 ... 22.7	mA	2 ms	
02.17	<i>AO2</i>	REAL	16	0 ... 22.7	mA	2 ms	
02.18	<i>AO3</i>	REAL	16	0 ... 22.7	mA	2 ms	
02.19	<i>AO4</i>	REAL	16	0 ... 22.7	mA	2 ms	
02.20	<i>Freq in</i>	REAL	32	-32768...32768	-	250 µs	
02.21	<i>Freq out</i>	REAL	32	0...32767	Hz	250 µs	
02.22	<i>FBA main cw</i>	Pb	32	0x00000000 ... 0xFFFFFFFF	-	500 µs	
02.24	<i>FBA main sw</i>	Pb	32	0x00000000 ... 0xFFFFFFFF	-	500 µs	
02.26	<i>FBA main ref1</i>	INT32	32	-2147483647 ... 2147483647	-	500 µs	
02.27	<i>FBA main ref2</i>	INT32	32	-2147483647 ... 2147483647	-	500 µs	
02.34	<i>Panel ref</i>	REAL	32	-32768...32768	rpm or %	10 ms	
02.36	<i>EFB main cw</i>	Pb	32	0x00000000 ... 0xFFFFFFFF	-	10 ms	
02.37	<i>EFB main sw</i>	Pb	32	0x00000000 ... 0xFFFFFFFF	-	10 ms	
02.38	<i>EFB main ref1</i>	INT32	32	-2147483647 ... 2147483647	-	10 ms	
02.39	<i>EFB main ref2</i>	INT32	32	-2147483647 ... 2147483647	-	10 ms	
02.40	<i>FBA setpoint</i>	REAL	16	0 ... 32768	%	-	
02.41	<i>FBA act val</i>	REAL	16	0 ... 32768	%	-	
02.42	<i>Shared DI</i>	Pb	32	0x00000000 ... 0xFFFFFFFF	-	10 ms	
02.43	<i>Shared signal 1</i>	REAL	32	0...32767	-	10 ms	
02.44	<i>Shared signal 2</i>	REAL	32	0...32767	-	10 ms	
<b>03 Control values</b>							
03.03	<i>SpeedRef unramp</i>	REAL	32	-30000...30000	rpm	250 µs	
03.05	<i>SpeedRef ramped</i>	REAL	32	-30000...30000	rpm	250 µs	
03.06	<i>SpeedRef used</i>	REAL	32	-30000...30000	rpm	250 µs	
03.07	<i>Speed error filt</i>	REAL	32	-30000...30000	rpm	250 µs	
03.08	<i>Acc comp torq</i>	REAL	16	-1600...1600	%	250 µs	
03.09	<i>Torq ref sp ctrl</i>	REAL	16	-1600...1600	%	250 µs	
03.13	<i>Torq ref to TC</i>	REAL	16	-1600...1600	%	250 µs	
03.14	<i>Torq ref used</i>	REAL	16	-1600...1600	%	250 µs	
03.17	<i>Flux actual</i>	REAL24	16	0...200	%	2 ms	
03.20	<i>Max speed ref</i>	REAL	16	0...30000	rpm	2 ms	
03.21	<i>Min speed ref</i>	REAL	16	-30000...0	rpm	2 ms	
<b>04 Appl values</b>							
04.01	<i>Act val</i>	REAL	32	0...32768	%	2 ms	
04.02	<i>Setpoint</i>	REAL	32	0...32768	%	2 ms	
04.04	<i>Process PID err</i>	REAL	32	-32768...32768	-	2 ms	
04.05	<i>Process PID out</i>	REAL	32	-32768...32768	-	2 ms	
04.06	<i>Process var1</i>	REAL	16	-32768...32768	-	10 ms	
04.07	<i>Process var2</i>	REAL	16	-32768...32768	-	10 ms	

312 Additional parameter data

No.	Name	Type	Data length	Range	Unit	Update time	Notes
04.08	<a href="#">Process var3</a>	REAL	16	-32768...32768	-	10 ms	
04.09	<a href="#">Counter ontime1</a>	UINT32	32	0...2147483647	s	10 ms	
04.10	<a href="#">Counter ontime2</a>	UINT32	32	0...2147483647	s	10 ms	
04.11	<a href="#">Counter edge1</a>	UINT32	32	0...2147483647	-	10 ms	
04.12	<a href="#">Counter edge2</a>	UINT32	32	0...2147483647	-	10 ms	
04.13	<a href="#">Counter value1</a>	UINT32	32	0...2147483647	-	10 ms	
04.14	<a href="#">Counter value2</a>	UINT32	32	0...2147483647	-	10 ms	
04.20	<a href="#">Act val 1 out</a>	REAL	32	0...32768	%	10 ms	
04.21	<a href="#">Act val 2 out</a>	REAL	32	0...32768	%	10 ms	
04.22	<a href="#">Act val %</a>	REAL	16	0...100	%	10 ms	
04.23	<a href="#">Setpoint val 1</a>	REAL	32	0...32768	%	10 ms	
04.24	<a href="#">Setpoint val 2</a>	REAL	32	0...32768	%	10 ms	
04.25	<a href="#">Setpoint val %</a>	REAL	16	0...100	%	10 ms	
04.26	<a href="#">Wake up level</a>	REAL	32	-32768...32768	-	10 ms	
04.27	<a href="#">Shared source</a>	UINT32	16	0...8	-	10 ms	
04.28	<a href="#">Pump runtime</a>	INT32	32	0...35791394.1	h	10 ms	
04.29	<a href="#">Trad 1 runtime</a>	INT32	32	0...35791394.1	h	10 ms	
04.30	<a href="#">Trad 2 runtime</a>	INT32	32	0...35791394.1	h	10 ms	
04.31	<a href="#">Trad 3 runtime</a>	INT32	32	0...35791394.1	h	10 ms	
04.32	<a href="#">Trad 4 runtime</a>	INT32	32	0...35791394.1	h	10 ms	
04.33	<a href="#">Trad 5 runtime</a>	INT32	32	0...35791394.1	h	10 ms	
04.34	<a href="#">Trad 6 runtime</a>	INT32	32	0...35791394.1	h	10 ms	
04.35	<a href="#">Trad 7 runtime</a>	INT32	32	0...35791394.1	h	10 ms	
04.36	<a href="#">Trad 8 runtime</a>	INT32	32	0...35791394.1	h	10 ms	
<b>05 Pump values</b>							
05.01	<a href="#">MF status</a>	UINT32	16	0...3	-	2 ms	
05.02	<a href="#">Trad pump cmd</a>	Pb	16	0b00000000 ... 0b11111111	-	10 ms	
05.03	<a href="#">Trad master</a>	UINT32	16	0...8	-	10 ms	
05.04	<a href="#">Nbr aux pumps on</a>	INT32	32	0...65535	-	10 ms	
05.05	<a href="#">Flow act</a>	REAL	32	0...32767	m <sup>3</sup> /h	10 ms	
05.06	<a href="#">Flow by head</a>	REAL	32	0...32767	m <sup>3</sup> /h	10 ms	
05.07	<a href="#">Flow by power</a>	REAL	32	0...32767	m <sup>3</sup> /h	10 ms	
05.08	<a href="#">Total flow</a>	UINT32	32	0...2147483647	m <sup>3</sup>	10 ms	
05.09	<a href="#">Bypass ref</a>	REAL	32	-32768...32768	rpm	10 ms	
05.10	<a href="#">Speed ref</a>	REAL	32	-32768...32767	rpm	10 ms	
05.20	<a href="#">kWh current read</a>	UINT32	32	0...2147483647	kWh	10 ms	
05.21	<a href="#">kWh prev read</a>	UINT32	32	0...2147483647	kWh	10 ms	
05.22	<a href="#">kWh posprev read</a>	UINT32	32	0...2147483647	kWh	10 ms	
05.23	<a href="#">kWh cur mon read</a>	UINT32	32	0...2147483647	kWh	10 ms	
05.24	<a href="#">kWh January</a>	UINT32	32	0...2147483647	kWh	10 ms	
05.25	<a href="#">kWh February</a>	UINT32	32	0...2147483647	kWh	10 ms	
05.26	<a href="#">kWh March</a>	UINT32	32	0...2147483647	kWh	10 ms	
05.27	<a href="#">kWh April</a>	UINT32	32	0...2147483647	kWh	10 ms	
05.28	<a href="#">kWh May</a>	UINT32	32	0...2147483647	kWh	10 ms	
05.29	<a href="#">kWh June</a>	UINT32	32	0...2147483647	kWh	10 ms	
05.30	<a href="#">kWh July</a>	UINT32	32	0...2147483647	kWh	10 ms	
05.31	<a href="#">kWh August</a>	UINT32	32	0...2147483647	kWh	10 ms	
05.32	<a href="#">kWh September</a>	UINT32	32	0...2147483647	kWh	10 ms	
05.33	<a href="#">kWh October</a>	UINT32	32	0...2147483647	kWh	10 ms	
05.34	<a href="#">kWh November</a>	UINT32	32	0...2147483647	kWh	10 ms	
05.35	<a href="#">kWh December</a>	UINT32	32	0...2147483647	kWh	10 ms	



No.	Name	Type	Data length	Range	Unit	Update time	Notes
05.36	<i>First in order</i>	UINT32	16	0...8	-	10 ms	
05.37	<i>Time autochg</i>	UINT32	32	0...1092.3	h	10 ms	
05.39	<i>Next start node</i>	UINT32	16	0...8	-	10 ms	
05.48	<i>Ramp status</i>	Pb	16	0b00000000... 0b11111111	-	10 ms	
<b>06 Drive status</b>							
06.01	<i>Status word1</i>	Pb	16	0x0000...0xFFFF	-	2 ms	
06.02	<i>Status word2</i>	Pb	16	0x0000...0xFFFF	-	2 ms	
06.03	<i>Speed ctrl stat</i>	Pb	16	0x0000...0xFFFF	-	250 µs	
06.05	<i>Limit word1</i>	Pb	16	0x0000...0xFFFF	-	250 µs	
06.07	<i>Torq lim status</i>	Pb	16	0x0000...0xFFFF	-	250 µs	
06.12	<i>Op mode ack</i>	enum	16	0...11	-	2 ms	
06.13	<i>Superv status</i>	Pb	16	0b000...0b111	-	2 ms	
06.14	<i>Timed func stat</i>	Pb	16	0b00000...0b11111	-	10 ms	
06.15	<i>Counter status</i>	Pb	16	0b000000...0b111111	-	10 ms	
06.17	<i>Bit inverted sw</i>	Pb	16	0b000000...0b111111	-	2 ms	
06.20	<i>Pump status word</i>	Pb	16	0x00000000 ... 0xFFFFFFFF	-	2 ms	
06.21	<i>Level status</i>	Pb	16	0x00000000 ... 0xFFFFFFFF	-	10 ms	
06.22	<i>MF status word</i>	Pb	16	0x00000000 ... 0xFFFFFFFF	-	2 ms	
<b>08 Alarms &amp; faults</b>							
08.01	<i>Active fault</i>	enum	16	0...65535	-	-	
08.02	<i>Last fault</i>	enum	16	0...2147483647	-	-	
08.03	<i>Fault time hi</i>	INT32	32	$-2^{31} \dots 2^{31} - 1$	(date)	-	
08.04	<i>Fault time lo</i>	INT32	32	00:00:00 ... 24:00:00	(time)	-	
08.05	<i>Alarm logger1</i>	UINT32	16	0x0000...0xFFFF	-	2 ms	
08.06	<i>Alarm logger2</i>	UINT32	16	0x0000...0xFFFF	-	2 ms	
08.07	<i>Alarm logger3</i>	UINT32	16	0x0000...0xFFFF	-	2 ms	
08.08	<i>Alarm logger4</i>	UINT32	16	0x0000...0xFFFF	-	2 ms	
08.09	<i>Alarm logger5</i>	UINT32	16	0x0000...0xFFFF	-	2 ms	
08.10	<i>Alarm logger6</i>	UINT32	16	0x0000...0xFFFF	-	2 ms	
08.15	<i>Alarm word1</i>	UINT32	16	0x0000...0xFFFF	-	2 ms	
08.16	<i>Alarm word2</i>	UINT32	16	0x0000...0xFFFF	-	2 ms	
08.17	<i>Alarm word3</i>	UINT32	16	0x0000...0xFFFF	-	2 ms	
08.18	<i>Alarm word4</i>	UINT32	16	0x0000...0xFFFF	-	2 ms	
08.20	<i>Pump fault word</i>	Pb	16	0x0000...0xFFFF	-	2 ms	
08.21	<i>Pump alarm word</i>	Pb	16	0x00000000 ... 0xFFFFFFFF	-	2 ms	
<b>09 System info</b>							
09.01	<i>Drive type</i>	INT32	16	-	-	-	
09.02	<i>Drive rating ID</i>	INT32	16	0...65535	-	-	
09.03	<i>Firmware ID</i>	Pb	16	-	-	-	
09.04	<i>Firmware ver</i>	Pb	16	-	-	-	
09.05	<i>Firmware patch</i>	Pb	16	-	-	-	
09.10	<i>Int logic ver</i>	Pb	32	-	-	-	
09.13	<i>Slot 1 VIE name</i>	INT32	16	0x0000...0xFFFF	-	-	
09.14	<i>Slot 1 VIE ver</i>	INT32	16	0x0000...0xFFFF	-	-	
09.20	<i>Option slot1</i>	INT32	16	0...25	-	-	
09.21	<i>Option slot2</i>	INT32	16	0...25	-	-	

## Parameter groups 10...99

No.	Name	Type	Data len.	Range	Unit	Default (Factory def macro)
<b>10 Start/stop/dir</b>						
10.01	<i>Ext1 start func</i>	enum	16	0...7	-	<i>In1</i>
10.02	<i>Ext1 start in1</i>	Bit pointer	32	-	-	<i>DI1</i>
10.03	<i>Ext1 start in2</i>	Bit pointer	32	-	-	C.FALSE
10.04	<i>Ext2 start func</i>	enum	16	0...7	-	<i>In1</i>
10.05	<i>Ext2 start in1</i>	Bit pointer	32	-	-	<i>DI1</i>
10.06	<i>Ext2 start in2</i>	Bit pointer	32	-	-	C.FALSE
10.10	<i>Fault reset sel</i>	Bit pointer	32	-	-	<i>DI3</i>
10.11	<i>Run enable</i>	Bit pointer	32	-	-	C.TRUE
10.13	<i>Em stop off3</i>	Bit pointer	32	-	-	C.TRUE
10.15	<i>Em stop off1</i>	Bit pointer	32	-	-	C.TRUE
10.17	<i>Start enable</i>	Bit pointer	32	-	-	C.TRUE
10.19	<i>Start inhibit</i>	enum	16	0...1	-	<i>Disabled</i>
10.20	<i>Start intrl func</i>	enum	16	0...1	-	<i>Off3 stop</i>
<b>11 Start/stop mode</b>						
11.01	<i>Start mode</i>	enum	16	0...2	-	<i>Automatic</i>
11.02	<i>Dc-magn time</i>	UINT32	16	0...10000	ms	500 ms
11.03	<i>Stop mode</i>	enum	16	1...2	-	<i>Coast</i>
11.04	<i>Dc hold speed</i>	REAL	16	0...1000	rpm	5.0 rpm
11.05	<i>Dc hold curr ref</i>	UINT32	16	0...100	%	30%
11.06	<i>Dc hold</i>	Bit pointer	32	-	-	C.FALSE
<b>12 Operating mode</b>						
12.01	<i>Ext1/Ext2 sel</i>	Bit pointer	32	-	-	<i>DI5</i>
12.05	<i>Ext2 ctrl mode</i>	enum	16	1...2	-	<i>PID</i>
<b>13 Analogue inputs</b>						
13.01	<i>AI1 filt time</i>	REAL	16	0...30	s	0.100 s
13.02	<i>AI1 max</i>	REAL	16	-22...22 mA or -11...11 V	mA or V	20.000 mA or 10.000 V
13.03	<i>AI1 min</i>	REAL	16	-22...22 mA or -11...11 V	mA or V	4.000 mA or 2.000 V
13.04	<i>AI1 max scale</i>	REAL	32	-32768...32768	-	1500.000
13.05	<i>AI1 min scale</i>	REAL	32	-32768...32768	-	0.000
13.06	<i>AI2 filt time</i>	REAL	16	0...30	s	0.100 s
13.07	<i>AI2 max</i>	REAL	16	-22...22 mA or -11...11 V	mA or V	20.000 mA or 10.000 V
13.08	<i>AI2 min</i>	REAL	16	-22...22 mA or -11...11 V	mA or V	4.000 mA or 2.000 V
13.09	<i>AI2 max scale</i>	REAL	32	-32768...32768	-	100.000
13.10	<i>AI2 min scale</i>	REAL	32	-32768...32768	-	0.000
13.11	<i>AI3 filt time</i>	REAL	16	0...30	s	0.100 s

No.	Name	Type	Data len.	Range	Unit	Default (Factory def macro)
13.12	<i>AI3 max</i>	REAL	16	-22...22 mA or -11...11 V	mA or V	22.000 mA or 10.000 V
13.13	<i>AI3 min</i>	REAL	16	-22...22 mA or -11...11 V	mA or V	4.000 mA or 2.000 V
13.14	<i>AI3 max scale</i>	REAL	32	-32768...32768	-	1500.000
13.15	<i>AI3 min scale</i>	REAL	32	-32768...32768	-	0.000
13.16	<i>AI4 filt time</i>	REAL	16	0...30	s	0.100 s
13.17	<i>AI4 max</i>	REAL	16	-22...22 mA or -11...11 V	mA or V	22.000 mA or 10.000 V
13.18	<i>AI4 min</i>	REAL	16	-22...22 mA or -11...11 V	mA or V	4.000 mA or 2.000 V
13.19	<i>AI4 max scale</i>	REAL	32	-32768...32768	-	1500.000
13.20	<i>AI4 min scale</i>	REAL	32	-32768...32768	-	0.000
13.21	<i>AI5 filt time</i>	REAL	16	0...30	s	0.100 s
13.22	<i>AI5 max</i>	REAL	16	-22...22 mA or -11...11 V	mA or V	22.000 mA or 10.000 V
13.23	<i>AI5 min</i>	REAL	16	-22...22 mA or -11...11 V	mA or V	4.000 mA or 2.000 V
13.24	<i>AI5 max scale</i>	REAL	32	-32768...32768	-	1500.000
13.25	<i>AI5 min scale</i>	REAL	32	-32768...32768	-	0.000
13.31	<i>AI tune</i>	enum	16	0...4	-	<i>No action</i>
13.32	<i>AI superv func</i>	enum	16	0...3	-	<i>No</i>
13.33	<i>AI superv cw</i>	UINT32	32	0b0000...0b1111	-	0b0000
<b>14 Digital I/O</b>						
14.01	<i>DI invert mask</i>	Pb	16	0b00000 ... 0b11111	-	0b00000
14.02	<i>DIO1 conf</i>	enum	16	0...2	-	<i>Output</i>
14.03	<i>DIO1 out src</i>	Bit pointer	32	-	-	<i>Ready</i>
14.04	<i>DIO1 Ton</i>	UINT32	16	0...3000	s	0.0 s
14.05	<i>DIO1 Toff</i>	UINT32	16	0...3000	s	0.0 s
14.06	<i>DIO2 conf</i>	enum	16	0...2	-	<i>Output</i>
14.07	<i>DIO2 out src</i>	Bit pointer	32	-	-	<i>Running</i>
14.08	<i>DIO2 Ton</i>	UINT32	16	0...3000	s	0.0 s
14.09	<i>DIO2 Toff</i>	UINT32	16	0...3000	s	0.0 s
14.10	<i>DIO3 conf</i>	enum	16	0...1	-	<i>Output</i>
14.11	<i>DIO3 out src</i>	Bit pointer	32	-	-	<i>Fault(-1)</i>
14.14	<i>DIO4 conf</i>	enum	16	0...1	-	<i>Output</i>
14.15	<i>DIO4 out src</i>	Bit pointer	32	-	-	<i>Ready relay</i>
14.18	<i>DIO5 conf</i>	enum	16	0...1	-	<i>Output</i>
14.19	<i>DIO5 out src</i>	Bit pointer	32	-	-	<i>Ref running</i>
14.22	<i>DIO6 conf</i>	enum	16	0...1	-	<i>Output</i>
14.23	<i>DIO6 out src</i>	Bit pointer	32	-	-	<i>Fault</i>
14.42	<i>RO1 src</i>	Bit pointer	32	-	-	<i>Ready</i>

No.	Name	Type	Data len.	Range	Unit	Default (Factory def macro)
14.43	<i>RO1 Ton</i>	UINT32	16	0...3000	s	0.0 s
14.44	<i>RO1 Toff</i>	UINT32	16	0...3000	s	0.0 s
14.45	<i>RO2 src</i>	Bit pointer	32	-	-	<i>RunningRelay</i>
14.48	<i>RO3 src</i>	Bit pointer	32	-	-	<i>Fault(-1)</i>
14.51	<i>RO4 src</i>	Bit pointer	32	-	-	<i>Ready relay</i>
14.54	<i>RO5 src</i>	Bit pointer	32	-	-	<i>Ref running</i>
14.57	<i>Freq in max</i>	REAL	16	3...32768	Hz	1000 Hz
14.58	<i>Freq in min</i>	REAL	16	3...32768	Hz	3 Hz
14.59	<i>Freq in max scal</i>	REAL	16	-32768...32768	-	1500
14.60	<i>Freq in min scal</i>	REAL	16	-32768...32768	-	0
14.61	<i>Freq out src</i>	Val pointer	32	-	-	P.01.01
14.62	<i>Freq out max src</i>	REAL	16	0...32768	-	1500
14.63	<i>Freq out min src</i>	REAL	16	0...32768	-	0
14.64	<i>Freq out max sca</i>	REAL	16	3...32768	Hz	1000 Hz
14.65	<i>Freq out min sca</i>	REAL	16	3...32768	Hz	3 Hz
14.66	<i>RO6 src</i>	Bit pointer	32	-	-	<i>Ref running</i>
14.72	<i>DIO invert mask</i>	Pb	16	0b0000000000 ... 0b1111111111	-	0b0000000000
<b>15 Analogue outputs</b>						
15.01	<i>AO1 src</i>	Val pointer	32	-	-	<i>Current</i>
15.02	<i>AO1 filt time</i>	REAL	16	0...30	s	0.100 s
15.03	<i>AO1 out max</i>	REAL	16	0 ... 22.7	mA	20.000 mA
15.04	<i>AO1 out min</i>	REAL	16	0 ... 22.7	mA	4.000 mA
15.05	<i>AO1 src max</i>	REAL	32	-32768...32768	-	100.000
15.06	<i>AO1 src min</i>	REAL	32	-32768...32768	-	0.000
15.07	<i>AO2 src</i>	Val pointer	32	-	-	<i>Speed rpm</i>
15.08	<i>AO2 filt time</i>	REAL	16	0...30	s	0.100 s
15.09	<i>AO2 out max</i>	REAL	16	0...22.7	mA	20.000 mA
15.10	<i>AO2 out min</i>	REAL	16	0...22.7	mA	4.000 mA
15.11	<i>AO2 src max</i>	REAL	32	-32768...32768	-	100.000
15.12	<i>AO2 src min</i>	REAL	32	-32768...32768	-	0.000
15.13	<i>AO3 src</i>	Val pointer	32	-	-	<i>Frequency</i>
15.14	<i>AO3 filt time</i>	REAL	16	0...30	s	0.100 s
15.15	<i>AO3 out max</i>	REAL	16	0 ... 22.7	mA	22.000 mA
15.16	<i>AO3 out min</i>	REAL	16	0 ... 22.7	mA	4.000 mA
15.17	<i>AO3 src max</i>	REAL	32	-32768...32768	-	50.000
15.18	<i>AO3 src min</i>	REAL	32	-32768...32768	-	0.000
15.25	<i>AO ctrl word</i>	UINT32	32	0b00...0b11	-	0b00
15.30	<i>AO calibration</i>	enum	16	0...4	-	<i>No action</i>
<b>16 System</b>						
16.01	<i>Local lock</i>	Bit pointer	32	-	-	C.FALSE

No.	Name	Type	Data len.	Range	Unit	Default (Factory def macro)
16.02	<i>Parameter lock</i>	enum	16	0...2	-	<i>Open</i>
16.03	<i>Pass code</i>	INT32	32	0...2147483647	-	0
16.04	<i>Param restore</i>	enum	16	0...2	-	<i>Done</i>
16.07	<i>Param save</i>	enum	16	0...1	-	<i>Done</i>
16.09	<i>User set sel</i>	enum	32	1...10	-	<i>No request</i>
16.10	<i>User set log</i>	Pb	32	0...4294967295	-	<i>N/A</i>
16.11	<i>User IO sel lo</i>	Bit pointer	32	-	-	C.FALSE
16.12	<i>User IO sel hi</i>	Bit pointer	32	-	-	C.FALSE
16.14	<i>Reset ChgParLog</i>	enum	16	0...1	-	<i>Done</i>
16.16	<i>Menu set active</i>	enum	16	0...32	-	<i>Full</i>
16.17	<i>Power unit</i>	enum	16	0...1	-	<i>kW</i>
16.18	<i>Fan ctrl mode</i>	enum	16	0...3	-	<i>Normal</i>
16.20	<i>Macro Read Only</i>	enum	16	0...6	-	<i>Factory def</i>
16.21	<i>Menu selection</i>	enum	16	0...2	-	<i>Full</i>
16.22	<i>Drive boot</i>	enum	32	0...1	-	<i>No action</i>
<b>19 Speed calculation</b>						
19.01	<i>Speed scaling</i>	REAL	16	0...30000	rpm	1500 rpm
19.02	<i>Speed fb sel</i>	enum	16	-	-	<i>Estimated</i>
19.03	<i>MotorSpeed filt</i>	REAL	32	0...10000	ms	8.000 ms
19.06	<i>Zero speed limit</i>	REAL	32	0...30000	rpm	30.00 rpm
19.07	<i>Zero speed delay</i>	UINT32	16	0...30000	ms	0 ms
19.08	<i>Above speed lim</i>	REAL	16	0...30000	rpm	0 rpm
19.09	<i>Speed TripMargin</i>	REAL	32	0...10000	rpm	500.0 rpm
19.10	<i>Speed window</i>	REAL	16	0...30000	rpm	100 rpm
<b>20 Limits</b>						
20.01	<i>Maximum speed</i>	REAL	32	0...30000	rpm	1500 rpm
20.02	<i>Minimum speed</i>	REAL	32	-30000...0	rpm	0 rpm
20.03	<i>Pos speed ena</i>	Bit pointer	32	-	-	C.TRUE
20.04	<i>Neg speed ena</i>	Bit pointer	32	-	-	C.FALSE
20.05	<i>Maximum current</i>	REAL	32	0...30000	A	0.00 A
20.06	<i>Torq lim sel</i>	Bit pointer	32	-	-	C.FALSE
20.07	<i>Maximum torque1</i>	REAL	16	0...1600	%	300.0%
20.08	<i>Minimum torque1</i>	REAL	16	-1600...0	%	-300.0%
20.09	<i>Maximum torque2</i>	REAL	16	-	-	<i>Max torque1</i>
20.10	<i>Minimum torque2</i>	REAL	16	-	-	<i>Min torque1</i>
20.12	<i>P motoring lim</i>	REAL	16	0...1600	%	300.0%
20.13	<i>P generating lim</i>	REAL	16	0...1600	%	300.0%
<b>21 Speed ref</b>						
21.01	<i>Speed ref1 sel</i>	Val pointer	32	-	-	<i>A11 scaled</i>
21.02	<i>Speed ref2 sel</i>	Val pointer	32	-	-	<i>Zero</i>

### 318 Additional parameter data

No.	Name	Type	Data len.	Range	Unit	Default (Factory def macro)
21.05	<i>Speed share</i>	REAL	16	-8...8	-	1.000
21.09	<i>SpeedRef min abs</i>	REAL	16	0...30000	rpm	0 rpm
<b>22 Speed ref ramp</b>						
22.02	<i>Acc time</i>	REAL	32	0...1800	s	5.000 s
22.03	<i>Dec time</i>	REAL	32	0...1800	s	5.000 s
22.06	<i>Shape time acc1</i>	REAL	32	0...1000	s	0.100 s
22.07	<i>Shape time acc2</i>	REAL	32	0...1000	s	0.100 s
22.08	<i>Shape time dec1</i>	REAL	32	0...1000	s	0.100 s
22.09	<i>Shape time dec2</i>	REAL	32	0...1000	s	0.100 s
22.12	<i>Em stop time</i>	REAL	32	0...1800	s	3.000 s
<b>23 Speed ctrl</b>						
23.01	<i>Proport gain</i>	REAL	16	0...200	-	5.00
23.02	<i>Integration time</i>	REAL	32	0...600	s	0.500 s
23.03	<i>Derivation time</i>	REAL	16	0...10	s	0.000 s
23.04	<i>Deriv filt time</i>	REAL	16	0...1000	ms	8.0 ms
23.05	<i>Acc comp DerTime</i>	REAL	32	0...600	s	0.00 s
23.06	<i>Acc comp Ftime</i>	REAL	16	0...1000	ms	8.0 ms
23.07	<i>Speed err Ftime</i>	REAL	16	0...1000	ms	0.0 ms
23.08	<i>Speed additive</i>	Val pointer	32	-	-	<i>Zero</i>
23.09	<i>Max torq sp ctrl</i>	REAL	16	-1600...1600	%	300.0%
23.10	<i>Min torq sp ctrl</i>	REAL	16	-1600...1600	%	-300.0%
23.11	<i>SpeedErr winFunc</i>	enum	16	0...2	-	<i>Disabled</i>
23.12	<i>SpeedErr win hi</i>	REAL	16	0...3000	rpm	0 rpm
23.13	<i>SpeedErr win lo</i>	REAL	16	0...3000	rpm	0 rpm
23.14	<i>Drooping rate</i>	REAL	16	0...100	%	0.00%
23.15	<i>PI adapt max sp</i>	REAL	16	0...30000	rpm	0 rpm
23.16	<i>PI adapt min sp</i>	REAL	16	0...30000	rpm	0 rpm
23.17	<i>Pcoef at min sp</i>	REAL	16	0...10	-	1.000
23.18	<i>Icoef at min sp</i>	REAL	16	0...10	-	1.000
23.20	<i>PI tune mode</i>	enum	16	0...4	-	<i>Done</i>
23.21	<i>Tune bandwidth</i>	REAL	16	0...2000	Hz	100.00 Hz
23.22	<i>Tune damping</i>	REAL	16	0...200	-	0.5
<b>25 Critical speed</b>						
25.01	<i>Crit speed sel</i>	enum	16	0...1	-	<i>Disable</i>
25.02	<i>Crit speed1 lo</i>	REAL	16	-30000...30000	rpm	0 rpm
25.03	<i>Crit speed1 hi</i>	REAL	16	-30000...30000	rpm	0 rpm
25.04	<i>Crit speed2 lo</i>	REAL	16	-30000...30000	rpm	0 rpm
25.05	<i>Crit speed2 hi</i>	REAL	16	-30000...30000	rpm	0 rpm
25.06	<i>Crit speed3 lo</i>	REAL	16	-30000...30000	rpm	0 rpm
25.07	<i>Crit speed3 hi</i>	REAL	16	-30000...30000	rpm	0 rpm

No.	Name	Type	Data len.	Range	Unit	Default (Factory def macro)
<b>26 Constant speeds</b>						
26.01	<i>Const speed func</i>	Pb	16	0b00...0b11	-	0b00
26.02	<i>Const speed sel1</i>	Bit pointer	32	-	-	<i>DI2</i>
26.03	<i>Const speed sel2</i>	Bit pointer	32	-	-	C.FALSE
26.04	<i>Const speed sel3</i>	Bit pointer	32	-	-	C.FALSE
26.06	<i>Const speed1</i>	REAL	16	-30000...30000	rpm	1200 rpm
26.07	<i>Const speed2</i>	REAL	16	-30000...30000	rpm	0 rpm
26.08	<i>Const speed3</i>	REAL	16	-30000...30000	rpm	0 rpm
26.09	<i>Const speed4</i>	REAL	16	-30000...30000	rpm	0 rpm
26.10	<i>Const speed5</i>	REAL	16	-30000...30000	rpm	0 rpm
26.11	<i>Const speed6</i>	REAL	16	-30000...30000	rpm	0 rpm
26.12	<i>Const speed7</i>	REAL	16	-30000...30000	rpm	0 rpm
<b>27 Process PID</b>						
27.01	<i>PID setpoint sel</i>	Val pointer	32	-	-	<i>Setpoint %</i>
27.12	<i>PID gain</i>	REAL	16	0...100	-	1.00
27.13	<i>PID integ time</i>	REAL	16	0...320	s	60.00 s
27.14	<i>PID deriv time</i>	REAL	16	0...10	s	0.00 s
27.15	<i>PID deriv filter</i>	REAL	16	0...10	s	1.00 s
27.16	<i>PID error inv</i>	Bit pointer	32	-	-	C.FALSE
27.18	<i>PID maximum</i>	REAL	32	-32768...32768	-	100.0
27.19	<i>PID minimum</i>	REAL	32	-32768...32768	-	0.0
27.30	<i>Pid ref freeze</i>	Bit pointer	32	-	-	<i>No</i>
27.31	<i>Pid out freeze</i>	Bit pointer	32	-	-	<i>No</i>
27.32	<i>Pipefill ref acc</i>	REAL	16	0...100	s	5 s
27.33	<i>Pipefill ref dec</i>	REAL	16	0...100	s	5 s
27.34	<i>PID bal ena</i>	Val pointer	32	-	-	C.FALSE
27.35	<i>PID bal ref</i>	REAL	32	-32768...32768	%	0.0%
27.36	<i>Pump scal speed</i>	Val pointer	32	-	-	<i>Speed scal</i>
<b>28 Procact sel</b>						
28.01	<i>Act val 1/2 sel</i>	Bit pointer	32	-	-	<i>Act val 1</i>
28.02	<i>Act val 1 src</i>	Val pointer	32	-	-	<i>A/2 scaled</i>
28.03	<i>Act val 2 src</i>	Val pointer	32	-	-	<i>Zero</i>
28.04	<i>Act val func</i>	enum	16	0...8	-	<i>Act1</i>
28.05	<i>Act max val</i>	REAL	32	0...32768	%	100.00%
28.06	<i>Act unit sel</i>	enum	32	0...32767	-	<i>%</i>
28.07	<i>Act FBA scaling</i>	enum	16	0...3	-	<i>Src/100</i>
<b>29 Setpoint sel</b>						
29.01	<i>Setpoint 1/2 sel</i>	Bit pointer	32	-	-	<i>Setpoint 1</i>
29.02	<i>Setpoint 1 src</i>	Val pointer	32	-	-	<i>Int set 1</i>
29.03	<i>Setpoint 2 src</i>	Val pointer	32	-	-	<i>Zero</i>

## 320 Additional parameter data

No.	Name	Type	Data len.	Range	Unit	Default (Factory def macro)
29.04	<i>Internal set 1</i>	REAL	32	0...32768	%	40.00%
29.05	<i>Internal set 2</i>	REAL	32	0...32768	%	60.00%
29.06	<i>Reference step 1</i>	REAL	16	0...100	%	0.00%
29.07	<i>Reference step 2</i>	REAL	16	0...100	%	0.00%
29.08	<i>Reference step 3</i>	REAL	16	0...100	%	0.00%
29.09	<i>Reference step 4</i>	REAL	16	0...100	%	0.00%
29.10	<i>Reference step 5</i>	REAL	16	0...100	%	0.00%
29.11	<i>Reference step 6</i>	REAL	16	0...100	%	0.00%
29.12	<i>Reference step 7</i>	REAL	16	0...100	%	0.00%
<b>30 Fault functions</b>						
30.01	<i>External fault</i>	Bit pointer	32	-	-	C.TRUE
30.02	<i>Speed ref safe</i>	REAL	16	-30000...30000	rpm	0 rpm
30.03	<i>Panel ctrl loss</i>	enum	16	0...3	-	<i>Fault</i>
30.04	<i>Mot phase loss</i>	enum	16	0...1	-	<i>Fault</i>
30.05	<i>Earth fault</i>	enum	16	0...2	-	<i>Fault</i>
30.06	<i>Suppl phs loss</i>	enum	16	0...1	-	<i>Fault</i>
30.07	<i>Sto diagnostic</i>	enum	16	1...4	-	<i>Fault</i>
30.08	<i>Wiring or earth</i>	enum	16	0...1	-	<i>Fault</i>
30.09	<i>Stall function</i>	Pb	16	0b000...0b111	-	0b111
30.10	<i>Stall curr lim</i>	REAL	16	0...1600	%	200.0%
30.11	<i>Stall freq hi</i>	REAL	16	0.5 ... 1000	Hz	15.0 Hz
30.12	<i>Stall time</i>	UINT32	16	0...3600	s	20 s
<b>31 Motor therm prot</b>						
31.01	<i>Mot temp1 prot</i>	enum	16	0...2	-	<i>No</i>
31.02	<i>Mot temp1 src</i>	enum	16	0...12	-	<i>Estimated</i>
31.03	<i>Mot temp1 almLim</i>	INT32	16	0...10000	°C	90 °C
31.04	<i>Mot temp1 fltLim</i>	INT32	16	0...10000	°C	110 °C
31.05	<i>Mot temp2 prot</i>	enum	16	0...2	-	<i>No</i>
31.06	<i>Mot temp2 src</i>	enum	16	0...12	-	<i>Estimated</i>
31.07	<i>Mot temp2 almLim</i>	INT32	16	0...10000	°C	90 °C
31.08	<i>Mot temp2 fltLim</i>	INT32	16	0...10000	°C	110 °C
31.09	<i>Mot ambient temp</i>	INT32	16	-60...100	°C	20 °C
31.10	<i>Mot load curve</i>	INT32	16	50...150	%	100%
31.11	<i>Zero speed load</i>	INT32	16	50...150	%	100%
31.12	<i>Break point</i>	INT32	16	0.01...500	Hz	45.00 Hz
31.13	<i>Mot nom tempRise</i>	INT32	16	0...300	°C	80 °C
31.14	<i>Mot therm time</i>	INT32	16	100...10000	s	256 s
<b>32 Automatic reset</b>						
32.01	<i>Autoreset sel</i>	Pb	16	0b000000...0b111111	-	0b000000
32.02	<i>Number of trials</i>	UINT32	16	0...5	-	0



No.	Name	Type	Data len.	Range	Unit	Default (Factory def macro)
32.03	<i>Trial time</i>	UINT32	16	1...600	s	30.0 s
32.04	<i>Delay time</i>	UINT32	16	0...120	s	0.0 s
<b>33 Supervision</b>						
33.01	<i>Superv1 func</i>	enum	16	0...4	-	<i>Disabled</i>
33.02	<i>Superv1 act</i>	Val pointer	32	-	-	<i>Speed rpm</i>
33.03	<i>Superv1 hi</i>	REAL	32	-32768...32768	-	0.00
33.04	<i>Superv1 lo</i>	REAL	32	-32768...32768	-	0.00
33.05	<i>Superv2 func</i>	enum	16	0...4	-	<i>Disabled</i>
33.06	<i>Superv2 act</i>	Val pointer	32	-	-	<i>Current</i>
33.07	<i>Superv2 hi</i>	REAL	32	-32768...32768	-	0.00
33.08	<i>Superv2 lo</i>	REAL	32	-32768...32768	-	0.00
33.09	<i>Superv3 func</i>	enum	16	0...4	-	<i>Disabled</i>
33.10	<i>Superv3 act</i>	Val pointer	32	-	-	<i>Torque</i>
33.11	<i>Superv3 hi</i>	REAL	32	-32768...32768	-	0.00
33.12	<i>Superv3 lo</i>	REAL	32	-32768...32768	-	0.00
33.17	<i>Bit0 invert src</i>	Bit pointer	32	-	-	<i>DI1</i>
33.18	<i>Bit1 invert src</i>	Bit pointer	32	-	-	<i>DI2</i>
33.19	<i>Bit2 invert src</i>	Bit pointer	32	-	-	<i>DI3</i>
33.20	<i>Bit3 invert src</i>	Bit pointer	32	-	-	<i>DI4</i>
33.21	<i>Bit4 invert src</i>	Bit pointer	32	-	-	<i>DI5</i>
33.22	<i>Bit5 invert src</i>	Bit pointer	32	-	-	<i>RO1</i>
<b>34 User load curve</b>						
34.01	<i>Overload func</i>	Pb	16	0b000000...0b111111	-	0b000000
34.02	<i>Underload func</i>	Pb	16	0b0000...0b1111	-	0b0000
34.03	<i>Load freq1</i>	REAL	16	1...500	Hz	5 Hz
34.04	<i>Load freq2</i>	REAL	16	1...500	Hz	25 Hz
34.05	<i>Load freq3</i>	REAL	16	1...500	Hz	43 Hz
34.06	<i>Load freq4</i>	REAL	16	1...500	Hz	50 Hz
34.07	<i>Load freq5</i>	REAL	16	1...500	Hz	500 Hz
34.08	<i>Load low lim1</i>	REAL	16	0...1600	%	10%
34.09	<i>Load low lim2</i>	REAL	16	0...1600	%	15%
34.10	<i>Load low lim3</i>	REAL	16	0...1600	%	25%
34.11	<i>Load low lim4</i>	REAL	16	0...1600	%	30%
34.12	<i>Load low lim5</i>	REAL	16	0...1600	%	30%
34.13	<i>Load high lim1</i>	REAL	16	0...1600	%	300%
34.14	<i>Load high lim2</i>	REAL	16	0...1600	%	300%
34.15	<i>Load high lim3</i>	REAL	16	0...1600	%	300%
34.16	<i>Load high lim4</i>	REAL	16	0...1600	%	300%
34.17	<i>Load high lim5</i>	REAL	16	0...1600	%	300%
34.18	<i>Load integ time</i>	UINT32	16	0...10000	s	100 s

## 322 Additional parameter data

No.	Name	Type	Data len.	Range	Unit	Default (Factory def macro)
34.19	<i>Load cool time</i>	UINT32	16	0...10000	s	20 s
34.20	<i>Underload time</i>	UINT32	16	0...10000	s	10 s
<b>35 Process variable</b>						
35.01	<i>Signal1 param</i>	Val pointer	32	-	-	<i>Speed %</i>
35.02	<i>Signal1 max</i>	REAL	32	-32768...32768	-	300.000
35.03	<i>Signal1 min</i>	REAL	32	-32768...32768	-	-300.000
35.04	<i>Proc var1 dispf</i>	enum	16	0...5	-	<b>3</b>
35.05	<i>Proc var1 unit</i>	enum	16	0...98	-	<b>4</b>
35.06	<i>Proc var1 max</i>	REAL	32	-32768...32768	-	300.000
35.07	<i>Proc var1 min</i>	REAL	32	-32768...32768	-	-300.000
35.08	<i>Signal2 param</i>	Val pointer	32	-	-	<i>Current %</i>
35.09	<i>Signal2 max</i>	REAL	32	-32768...32768	-	300.000
35.10	<i>Signal2 min</i>	REAL	32	-32768...32768	-	-300.000
35.11	<i>Proc var2 dispf</i>	enum	16	0...5	-	<b>3</b>
35.12	<i>Proc var2 unit</i>	enum	16	0...98	-	<b>4</b>
35.13	<i>Proc var2 max</i>	REAL	32	-32768...32768	-	300.000
35.14	<i>Proc var2 min</i>	REAL	32	-32768...32768	-	-300.000
35.15	<i>Signal3 param</i>	Val pointer	32	-	-	<i>Torque</i>
35.16	<i>Signal3 max</i>	REAL	32	-32768...32768	-	300.000
35.17	<i>Signal3 min</i>	REAL	32	-32768...32768	-	-300.000
35.18	<i>Proc var3 dispf</i>	enum	16	0...5	-	<b>3</b>
35.19	<i>Proc var3 unit</i>	enum	16	0...98	-	<b>4</b>
35.20	<i>Proc var3 max</i>	REAL	32	-32768...32768	-	300.000
35.21	<i>Proc var3 min</i>	REAL	32	-32768...32768	-	-300.000
<b>36 Timed functions</b>						
36.01	<i>Timers enable</i>	Bit pointer	32	-	-	C.FALSE
36.02	<i>Timers mode</i>	Pb	16	0b0000...0b1111	-	0b0000
36.03	<i>Start time1</i>	UINT32	32	00:00:00 ... 24:00:00	(time)	00:00:00
36.04	<i>Stop time1</i>	UINT32	32	00:00:00 ... 24:00:00	(time)	00:00:00
36.05	<i>Start day1</i>	enum	16	1...7	-	<i>Monday</i>
36.06	<i>Stop day1</i>	enum	16	1...7	-	<i>Monday</i>
36.07	<i>Start time2</i>	UINT32	32	00:00:00 ... 24:00:00	(time)	00:00:00
36.08	<i>Stop time2</i>	UINT32	32	00:00:00 ... 24:00:00	(time)	00:00:00
36.09	<i>Start day2</i>	enum	16	1...7	-	<i>Monday</i>
36.10	<i>Stop day2</i>	enum	16	1...7	-	<i>Monday</i>
36.11	<i>Start time3</i>	UINT32	32	00:00:00 ... 24:00:00	(time)	00:00:00
36.12	<i>Stop time3</i>	UINT32	32	00:00:00 ... 24:00:00	(time)	00:00:00
36.13	<i>Start day3</i>	enum	16	1...7	-	<i>Monday</i>
36.14	<i>Stop day3</i>	enum	16	1...7	-	<i>Monday</i>
36.15	<i>Start time4</i>	UINT32	32	00:00:00 ... 24:00:00	(time)	00:00:00

No.	Name	Type	Data len.	Range	Unit	Default (Factory def macro)
36.16	<i>Stop time4</i>	UINT32	32	00:00:00 ... 24:00:00	(time)	00:00:00
36.17	<i>Start day4</i>	enum	16	1...7	-	<i>Monday</i>
36.18	<i>Stop day4</i>	enum	16	1...7	-	<i>Monday</i>
36.19	<i>Boost signal</i>	Bit pointer	32	-	-	C.FALSE
36.20	<i>Boost time</i>	UINT32	32	00:00:00 ... 24:00:00	(time)	00:00:00
36.21	<i>Timed func1</i>	Pb	16	0b00000...0b11111	-	0b00000
36.22	<i>Timed func2</i>	Pb	16	0b00000...0b11111	-	0b00000
36.23	<i>Timed func3</i>	Pb	16	0b00000...0b11111	-	0b00000
36.24	<i>Timed func4</i>	Pb	16	0b00000...0b11111	-	0b00000
<b>38 Flux ref</b>						
38.01	<i>Flux ref</i>	REAL	16	0...200	%	100%
38.03	<i>U/f curve func</i>	enum	16	0...2	-	<i>Linear</i>
38.04	<i>U/f curve freq1</i>	REAL	16	1...500	%	10%
38.05	<i>U/f curve freq2</i>	REAL	16	1...500	%	30%
38.06	<i>U/f curve freq3</i>	REAL	16	1...500	%	50%
38.07	<i>U/f curve freq4</i>	REAL	16	1...500	%	70%
38.08	<i>U/f curve freq5</i>	REAL	16	1...500	%	90%
38.09	<i>U/f curve volt1</i>	REAL	16	0...200	%	20%
38.10	<i>U/f curve volt2</i>	REAL	16	0...200	%	40%
38.11	<i>U/f curve volt3</i>	REAL	16	0...200	%	60%
38.12	<i>U/f curve volt4</i>	REAL	16	0...200	%	80%
38.13	<i>U/f curve volt5</i>	REAL	16	0...200	%	100%
38.16	<i>Flux ref pointer</i>	Val pointer	32	-	-	P.38.01
<b>40 Motor control</b>						
40.01	<i>Motor noise</i>	enum	16	0...3	-	<i>Default</i>
40.02	<i>Sf ref</i>	REAL24	32	1.0...8.0	kHz	3.0 kHz
40.03	<i>Slip gain</i>	REAL24	32	0...200	%	100%
40.04	<i>Voltage reserve</i>	REAL24	32	-4...50	%	-2%
40.07	<i>IR-compensation</i>	REAL24	32	0...50	%	0.00%
40.10	<i>Flux braking</i>	enum	16	0...2	-	<i>Disabled</i>
40.11	<i>Mmodel t adapt</i>	enum	16	0...1	-	<i>Disabled</i>
<b>44 Maintenance</b>						
44.01	<i>Ontime1 func</i>	Pb	16	0b00...0b11	-	0b01
44.02	<i>Ontime1 src</i>	Bit pointer	32	-	-	<i>Running</i>
44.03	<i>Ontime1 limit</i>	UINT32	32	0...2147483647	s	36000000 s
44.04	<i>Ontime1 alm sel</i>	enum	16	0...5	-	<i>Mot bearing</i>
44.05	<i>Ontime2 func</i>	Pb	16	0b00...0b11	-	0b01
44.06	<i>Ontime2 src</i>	Bit pointer	32	-	-	<i>Charged</i>
44.07	<i>Ontime2 limit</i>	UINT32	32	0...2147483647	s	15768000 s
44.08	<i>Ontime2 alm sel</i>	enum	16	0...5	-	<i>Device clean</i>

## 324 Additional parameter data

No.	Name	Type	Data len.	Range	Unit	Default (Factory def macro)
44.09	<i>Edge count1 func</i>	Pb	16	0b00...0b11	-	0b01
44.10	<i>Edge count1 src</i>	Bit pointer	32	-	-	<i>Charged</i>
44.11	<i>Edge count1 lim</i>	UINT32	32	0...2147483647	-	5000
44.12	<i>Edge count1 div</i>	UINT32	32	0...2147483647	-	1
44.13	<i>Edg cnt1 alm sel</i>	enum	16	0...5	-	<i>Dc-charge</i>
44.14	<i>Edge count2 func</i>	Pb	16	0b00...0b11	-	0b01
44.15	<i>Edge count2 src</i>	Bit pointer	32	-	-	<i>RO1</i>
44.16	<i>Edge count2 lim</i>	UINT32	32	0...2147483647	-	10000
44.17	<i>Edge count2 div</i>	UINT32	32	0...2147483647	-	1
44.18	<i>Edg cnt2 alm sel</i>	enum	16	0...5	-	<i>Output relay</i>
44.19	<i>Val count1 func</i>	Pb	16	0b00...0b11	-	0b01
44.20	<i>Val count1 src</i>	Val pointer	32	-	-	<i>Speed rpm</i>
44.21	<i>Val count1 lim</i>	UINT32	32	0...2147483647	-	13140000
44.22	<i>Val count1 div</i>	UINT32	32	0...2147483647	-	6000
44.23	<i>Val cnt1 alm sel</i>	enum	16	0...1	-	<i>Mot bearing</i>
44.24	<i>Val count2 func</i>	Pb	16	0b00...0b11	-	0b01
44.25	<i>Val count2 src</i>	Val pointer	32	-	-	<i>Speed rpm</i>
44.26	<i>Val count2 lim</i>	UINT32	32	0...2147483647	-	6570000
44.27	<i>Val count2 div</i>	UINT32	32	0...2147483647	-	6000
44.28	<i>Val cnt2 alm sel</i>	enum	16	0...1	-	<i>Value2</i>
44.29	<i>Fan ontime lim</i>	UINT32	32	0...35791394.1	h	0.00 h
44.30	<i>Runtime lim</i>	UINT32	32	0...35791394.1	h	0.00 h
44.31	<i>Runtime alm sel</i>	enum	16	1...5	-	<i>Device clean</i>
44.32	<i>kWh inv lim</i>	UINT32	32	0...2147483647	kWh	0 kWh
44.33	<i>kWh inv alm sel</i>	enum	16	1...5	-	<i>Device clean</i>
44.34	<i>Counter reset</i>	Bit pointer	32	-	-	C.FALSE
<b>45 Energy optimising</b>						
45.01	<i>Energy optim</i>	enum	16	0...1	-	<i>Enable</i>
45.02	<i>Energy tariff1</i>	UINT32	32	0...21474836.47	-	0.65 GBP
45.06	<i>E tariff unit</i>	enum	16	0...2	-	<i>Local</i>
45.07	<i>CO2 Conv factor</i>	REAL	16	0...10	-	0.5
45.08	<i>Pump ref power</i>	REAL	16	0...1000	%	100.0%
45.09	<i>Energy reset</i>	enum	16	0...1	-	<i>Done</i>
<b>47 Voltage ctrl</b>						
47.01	<i>Overvolt ctrl</i>	enum	16	0...1	-	<i>Enable</i>
47.02	<i>Undervolt ctrl</i>	enum	16	0...1	-	<i>Enable</i>
47.03	<i>Sup volt auto ld</i>	enum	16	0...1	-	<i>Enable</i>
47.04	<i>Supply voltage</i>	REAL	16	0...1000	V	400.0 V
<b>49 Data storage</b>						
49.01	<i>Data storage1</i>	UINT32	16	-32768...32767	-	0

No.	Name	Type	Data len.	Range	Unit	Default (Factory def macro)
49.02	<a href="#">Data storage2</a>	UINT32	16	-32768...32767	-	0
49.03	<a href="#">Data storage3</a>	UINT32	16	-32768...32767	-	0
49.04	<a href="#">Data storage4</a>	UINT32	16	-32768...32767	-	0
49.05	<a href="#">Data storage5</a>	UINT32	32	-2147483647 ... 2147483647	-	0
49.06	<a href="#">Data storage6</a>	UINT32	32	-2147483647 ... 2147483647	-	0
49.07	<a href="#">Data storage7</a>	UINT32	32	-2147483647 ... 2147483647	-	0
49.08	<a href="#">Data storage8</a>	UINT32	32	-2147483647 ... 2147483647	-	0
<b>50 Fieldbus</b>						
50.01	<a href="#">FBA enable</a>	enum	16	0...1	-	<a href="#">Disable</a>
50.02	<a href="#">Comm loss func</a>	enum	16	0...3	-	<a href="#">No</a>
50.03	<a href="#">Comm loss t out</a>	UINT32	16	0.3...6553.5	s	0.3 s
50.04	<a href="#">FBA ref1 modesel</a>	enum	16	0...2	-	<a href="#">Speed</a>
50.05	<a href="#">FBA ref2 modesel</a>	enum	16	0...2	-	<a href="#">Speed</a>
50.06	<a href="#">FBA act1 tr src</a>	Val pointer	32	-	-	P.01.01
50.07	<a href="#">FBA act2 tr src</a>	Val pointer	32	-	-	P.01.06
50.08	<a href="#">FBA sw bit12 src</a>	Bit pointer	32	-	-	C.FALSE
50.09	<a href="#">FBA sw bit13 src</a>	Bit pointer	32	-	-	C.FALSE
50.10	<a href="#">FBA sw bit14 src</a>	Bit pointer	32	-	-	C.FALSE
50.11	<a href="#">FBA sw bit15 src</a>	Bit pointer	32	-	-	C.FALSE
50.12	<a href="#">FB comm speed</a>	enum	16	0...2	-	<a href="#">Low</a>
50.15	<a href="#">FBA cw used</a>	Val pointer	32	-	-	P.02.22
50.20	<a href="#">Fb main sw func</a>	Pb	16	0b000...0b111	-	0b001
50.21	<a href="#">Comm loss enable</a>	Pb	16	0b00...0b11	-	0b11
<b>51 FBA settings</b>						
51.01	<a href="#">FBA type</a>	UINT32	16	0...65535	-	0
51.02	<a href="#">FBA par2</a>	UINT32	16	0...65535	-	0
...	...	...	...	...	...	...
51.26	<a href="#">FBA par26</a>	UINT32	16	0...65535	-	0
51.27	<a href="#">FBA par refresh</a>	enum	16	0...1	-	<a href="#">Done</a>
51.28	<a href="#">Par table ver</a>	UINT32	16	0x0000...0xFFFF	-	-
51.29	<a href="#">Drive type code</a>	UINT32	16	0...65535	-	-
51.30	<a href="#">Mapping file ver</a>	UINT32	16	0...65535	-	-
51.31	<a href="#">D2FBA comm sta</a>	enum	16	0...6	-	<a href="#">Idle</a>
51.32	<a href="#">FBA comm sw ver</a>	UINT32	16	0x0000...0xFFFF	-	-
51.33	<a href="#">FBA appl sw ver</a>	UINT32	16	0x0000...0xFFFF	-	-
<b>52 FBA data in</b>						
52.01	<a href="#">FBA data in1</a>	UINT32	16	0...9999	-	0
...	...	...	...	...	...	...
52.12	<a href="#">FBA data in12</a>	UINT32	16	0...9999	-	0

## 326 Additional parameter data

No.	Name	Type	Data len.	Range	Unit	Default (Factory def macro)
<b>53 FBA data out</b>						
53.01	<i>FBA data out1</i>	UINT32	16	0...9999	-	0
...	...	...	...	...	...	...
53.12	<i>FBA data out12</i>	UINT32	16	0...9999	-	0
<b>56 Panel display</b>						
56.01	<i>Signal1 param</i>	UINT32	32	-	-	P.01.40
56.02	<i>Signal2 param</i>	UINT32	32	-	-	P.01.04
56.03	<i>Signal3 param</i>	UINT32	32	-	-	P.01.41
56.04	<i>Signal1 mode</i>	INT32		-1...3	-	<i>Normal</i>
56.05	<i>Signal2 mode</i>	INT32		-1...3	-	<i>Normal</i>
56.06	<i>Signal3 mode</i>	INT32		-1...3	-	<i>Normal</i>
56.07	<i>Local ref unit</i>	UINT32		0...1	-	<i>rpm</i>
56.08	<i>Speed filt time</i>	REAL	32	0...10000	ms	250.0 ms
56.09	<i>Torque filt time</i>	REAL	32	0...10000	ms	100.0 ms
<b>58 Embedded Modbus</b>						
58.01	<i>Protocol ena sel</i>	UINT32	32	0...1	-	<i>Disabled</i>
58.03	<i>Node address</i>	UINT32	32	0...247	-	1
58.04	<i>Baud rate</i>	UINT32	32	0...6	-	<i>9600</i>
58.05	<i>Parity</i>	UINT32	32	0...3	-	<i>8 none 1</i>
58.06	<i>Control profile</i>	UINT32	32	0...3	-	<i>ABB Enhanced</i>
58.07	<i>Comm loss t out</i>	UINT32	32	0...60000	ms	600
58.08	<i>Comm loss mode</i>	UINT32	32	0...2	-	<i>None</i>
58.09	<i>Comm loss action</i>	UINT32	32	0...3	-	<i>None</i>
58.10	<i>Refresh settings</i>	UINT32	32	0...1	-	<i>Done</i>
58.11	<i>Reference scale</i>	Pb	16	1...65535	-	100
58.12	<i>EFB comm speed</i>	enum	16	0...1	-	<i>Low</i>
58.15	<i>Comm diagnostics</i>	Pb	16	0x0000...0xFFFF	-	0x0000
58.16	<i>Received packets</i>	UINT32	32	0...65535	-	0
58.17	<i>Transm packets</i>	UINT32	32	0...65535	-	0
58.18	<i>All packets</i>	UINT16	16	0...65535	-	0
58.19	<i>UART errors</i>	UINT16	16	0...65535	-	0
58.20	<i>CRC errors</i>	UINT16	16	0...65535	-	0
58.21	<i>Raw CW LSW</i>	Pb	16	0x0000...0xFFFF	-	0x0000
58.22	<i>Raw CW MSW</i>	Pb	16	0x0000...0xFFFF	-	0x0000
58.23	<i>Raw SW LSW</i>	Pb	16	0x0000...0xFFFF	-	0x0000
58.24	<i>Raw SW MSW</i>	Pb	16	0x0000...0xFFFF	-	0x0000
58.25	<i>Raw Ref 1 LSW</i>	Pb	16	0x0000...0xFFFF	-	0x0000
58.26	<i>Raw Ref 1 MSW</i>	Pb	16	0x0000...0xFFFF	-	0x0000
58.27	<i>Raw Ref 2 LSW</i>	Pb	16	0x0000...0xFFFF	-	0x0000
58.28	<i>Raw Ref 2 MSW</i>	Pb	16	0x0000...0xFFFF	-	0x0000

No.	Name	Type	Data len.	Range	Unit	Default (Factory def macro)
58.30	<i>Transmit delay</i>	UINT16	16	0...65535	ms	0
58.31	<i>Ret app errors</i>	UINT16	16	0...1	-	<i>Yes</i>
58.32	<i>Word order</i>	UINT32	32	0...1	-	<i>LSW MSW</i>
58.35	<i>Data I/O 1</i>	UINT16	16	0...9999	-	0
...	...	...	...	...	...	...
58.58	<i>Data I/O 24</i>	UINT16	16	0...9999	-	0
<b>64 Load analyzer</b>						
64.01	<i>PVL signal</i>	Val pointer	32	-	-	<i>Power inu</i>
64.02	<i>PVL filt time</i>	REAL	16	0...120	s	2.00 s
64.03	<i>Reset loggers</i>	Bit pointer	32	-	-	C.FALSE
64.04	<i>AL signal</i>	Val pointer	32	-	-	<i>Power motor</i>
64.05	<i>AL signal base</i>	REAL	32	0...32768	-	100.00
64.06	<i>PVL peak value1</i>	REAL	32	-32768...32768	-	-
64.07	<i>Date of peak</i>	UINT32	32	01.01.80...	d	-
64.08	<i>Time of peak</i>	UINT32	32	00:00:00...23:59:59	s	-
64.09	<i>Current at peak</i>	REAL	32	-32768...32768	A	-
64.10	<i>Dc volt at peak</i>	REAL	32	0...2000	V	-
64.11	<i>Speed at peak</i>	REAL	32	-32768...32768	rpm	-
64.12	<i>Date of reset</i>	UINT32	32	01.01.80...	d	-
64.13	<i>Time of reset</i>	UINT32	32	00:00:00...23:59:59	s	-
64.14	<i>AL1 0 to 10%</i>	REAL	16	0...100	%	-
64.15	<i>AL1 10 to 20%</i>	REAL	16	0...100	%	-
64.16	<i>AL1 20 to 30%</i>	REAL	16	0...100	%	-
64.17	<i>AL1 30 to 40%</i>	REAL	16	0...100	%	-
64.18	<i>AL1 40 to 50%</i>	REAL	16	0...100	%	-
64.19	<i>AL1 50 to 60%</i>	REAL	16	0...100	%	-
64.20	<i>AL1 60 to 70%</i>	REAL	16	0...100	%	-
64.21	<i>AL1 70 to 80%</i>	REAL	16	0...100	%	-
64.22	<i>AL1 80 to 90%</i>	REAL	16	0...100	%	-
64.23	<i>AL1 over 90%</i>	REAL	16	0...100	%	-
64.24	<i>AL2 0 to 10%</i>	REAL	16	0...100	%	-
64.25	<i>AL2 10 to 20%</i>	REAL	16	0...100	%	-
64.26	<i>AL2 20 to 30%</i>	REAL	16	0...100	%	-
64.27	<i>AL2 30 to 40%</i>	REAL	16	0...100	%	-
64.28	<i>AL2 40 to 50%</i>	REAL	16	0...100	%	-
64.29	<i>AL2 50 to 60%</i>	REAL	16	0...100	%	-
64.30	<i>AL2 60 to 70%</i>	REAL	16	0...100	%	-
64.31	<i>AL2 70 to 80%</i>	REAL	16	0...100	%	-
64.32	<i>AL2 80 to 90%</i>	REAL	16	0...100	%	-
64.33	<i>AL2 over 90%</i>	REAL	16	0...100	%	-

328 Additional parameter data

No.	Name	Type	Data len.	Range	Unit	Default (Factory def macro)
<b>75 Pump logic</b>						
75.01	<i>Operation mode</i>	enum	16	0...3	-	<i>Off</i>
75.02	<i>Nbr of pumps</i>	UINT32	16	0...8	-	8
75.03	<i>Follower mode</i>	enum	16	0...2	-	<i>Master speed</i>
75.04	<i>Follower ref</i>	REAL	16	0...32767	rpm	1300 rpm
75.05	<i>Start speed 1</i>	UINT32	32	0...32767	rpm	1300 rpm
75.06	<i>Start speed 2</i>	UINT32	32	0...32767	rpm	1300 rpm
75.07	<i>Start speed 3</i>	UINT32	32	0...32767	rpm	1300 rpm
75.08	<i>Start speed 4</i>	UINT32	32	0...32767	rpm	1300 rpm
75.09	<i>Start speed 5</i>	UINT32	32	0...32767	rpm	1300 rpm
75.10	<i>Start speed 6</i>	UINT32	32	0...32767	rpm	1300 rpm
75.11	<i>Start speed 7</i>	UINT32	32	0...32767	rpm	1300 rpm
75.12	<i>Stop speed 1</i>	UINT32	32	0...32767	rpm	800 rpm
75.13	<i>Stop speed 2</i>	UINT32	32	0...32767	rpm	800 rpm
75.14	<i>Stop speed 3</i>	UINT32	32	0...32767	rpm	800 rpm
75.15	<i>Stop speed 4</i>	UINT32	32	0...32767	rpm	800 rpm
75.16	<i>Stop speed 5</i>	UINT32	32	0...32767	rpm	800 rpm
75.17	<i>Stop speed 6</i>	UINT32	32	0...32767	rpm	800 rpm
75.18	<i>Stop speed 7</i>	UINT32	32	0...32767	rpm	800 rpm
75.19	<i>Start delay</i>	UINT32	16	0...12600	s	10 s
75.20	<i>Stop delay</i>	UINT32	16	0...12600	s	10 s
75.21	<i>Speed hold on</i>	UINT32	16	0...100	s	0 s
75.22	<i>Speed hold off</i>	UINT32	16	0...100	s	0 s
75.23	<i>Min pumps allow</i>	UINT32	16	0...8	-	1
75.24	<i>Max pumps allow</i>	UINT32	16	0...8	-	8
75.25	<i>Drive start dly</i>	UINT32	16	0...600	s	0 s
75.26	<i>Master speed acc</i>	UINT32	32	0...1800	s	1 s
75.27	<i>Master speed dec</i>	UINT32	32	0...1800	s	1 s
75.30	<i>Quick ramp mode</i>	Pb	16	0b00...0b11	-	0b00
75.31	<i>Quick ramp acc1</i>	REAL	32	0.000...1800.000	s	1.000 s
75.32	<i>Quick ramp dec1</i>	REAL	32	0.000...1800.000	s	1.000 s
75.33	<i>QR 1/2 swtch</i>	Bit pointer	32	-	-	Speed
75.34	<i>QR 1/2 swtch spd</i>	REAL	16	0.0...30000.0	rpm	700.0 rpm
75.35	<i>Quick ramp acc2</i>	REAL	32	0.000...1800.000	s	3.000 s
75.36	<i>Quick ramp dec2</i>	REAL	32	0.000...1800.000	s	3.000 s
75.37	<i>QR/NR swtch</i>	Bit pointer	32	-	-	Speed
75.38	<i>QR/NR swtch spd</i>	REAL	16	0.0...30000.0	rpm	1200.0 rpm
<b>76 MF communication</b>						
76.01	<i>Enable MF comm</i>	enum	16	0...1	-	<i>No</i>
76.02	<i>Pump node</i>	UINT32	16	0...8	-	1



No.	Name	Type	Data len.	Range	Unit	Default (Factory def macro)
76.03	<i>Master enable</i>	Bit pointer	32	-	-	<i>Yes</i>
76.04	<i>Pump prior sel</i>	Bit pointer	32	-	-	<i>Choice 1</i>
76.05	<i>Prior choice 1</i>	UINT32	16	1...4	-	1
76.06	<i>Prior choice 2</i>	UINT32	16	1...4	-	1
76.07	<i>Mstr loss action</i>	enum	16	0...2	-	<i>Const speed</i>
76.08	<i>Mstr loss delay</i>	UINT32	16	0...3600	s	2 s
76.09	<i>Start order corr</i>	UINT32	16	0...1	-	<i>Optimal</i>
76.10	<i>Master location</i>	UINT32	16	0...1	-	<i>Stable</i>
76.11	<i>Shared IO enable</i>	UINT32	16	0...1	-	<i>No</i>
76.12	<i>Set as source</i>	Bit pointer	16	-	-	<i>No</i>
76.13	<i>Shared signal 1</i>	Val pointer	32	-	-	<i>A11 scaled</i>
76.14	<i>Shared signal 2</i>	Val pointer	32	-	-	<i>A12 scaled</i>
76.15	<i>Share lost actn</i>	UINT32	16	0...3	-	<i>Alarm</i>
76.16	<i>Share lost delay</i>	UINT32	16	0...3600	s	10 s
<b>77 Pump sleep</b>						
77.01	<i>Sleep mode sel</i>	enum	16	0...4	-	<i>Internal</i>
77.02	<i>Sleep int sel</i>	Val pointer	32	-	-	<i>Speed %</i>
77.03	<i>Sleep level</i>	REAL	32	-32768...32767	-	20.00
77.04	<i>Sleep delay</i>	UINT32	16	0...12600	s	60 s
77.05	<i>Sleep ext sel</i>	Bit pointer	32	-	-	<i>Not used</i>
77.06	<i>Sleep boost step</i>	REAL	16	0...32767	%	0.00%
77.07	<i>Sleep boost time</i>	UINT32	16	0...100	s	0 s
77.08	<i>Wake up mode sel</i>	enum	16	0...3	-	<i>Wake &gt; ref</i>
77.09	<i>Wake up ext src</i>	Val pointer	32	-	-	<i>Proc act</i>
77.10	<i>Wake up level</i>	REAL	32	-32768...32767	-	90.00
77.11	<i>Wake up delay</i>	UINT32	16	0...100	s	10 s
<b>78 Pump autochange</b>						
78.01	<i>Autochg style</i>	enum	16	0...3	-	<i>No</i>
78.02	<i>Autochg trad</i>	enum	16	0...1	-	<i>All</i>
78.03	<i>Interlock mode</i>	enum	16	0...1	-	<i>Not used</i>
78.04	<i>Autochg level</i>	UINT32	32	0...32767	rpm	0 rpm
78.05	<i>Autochg interval</i>	REAL	32	0...1092.3	h	0.02 h
78.06	<i>Interlock pump 1</i>	Bit pointer	32	-	-	<i>Not used</i>
78.07	<i>Interlock pump 2</i>	Bit pointer	32	-	-	<i>Not used</i>
78.08	<i>Interlock pump 3</i>	Bit pointer	32	-	-	<i>Not used</i>
78.09	<i>Interlock pump 4</i>	Bit pointer	32	-	-	<i>Not used</i>
78.10	<i>Interlock pump 5</i>	Bit pointer	32	-	-	<i>Not used</i>
78.11	<i>Interlock pump 6</i>	Bit pointer	32	-	-	<i>Not used</i>
78.12	<i>Interlock pump 7</i>	Bit pointer	32	-	-	<i>Not used</i>
78.13	<i>Interlock pump 8</i>	Bit pointer	32	-	-	<i>Not used</i>

### 330 Additional parameter data

No.	Name	Type	Data len.	Range	Unit	Default (Factory def macro)
78.14	<i>Runtime change</i>	enum	16	0...11	-	<i>No</i>
78.15	<i>Runtime diff</i>	UINT32	32	0...2147483647	h	0 h
<b>79 Level control</b>						
79.01	<i>Level mode</i>	enum	16	0...2	-	<i>Off</i>
79.02	<i>Stopping mode</i>	enum	16	0...1	-	<i>Common stop</i>
79.03	<i>Low level</i>	REAL	16	0...32767	%	0.00%
79.04	<i>Low switch</i>	Bit pointer	32	-	-	<i>Not used</i>
79.05	<i>Stop level</i>	REAL	16	-	-	20.00%
79.06	<i>Start 1 level</i>	REAL	16	-	-	40.00%
79.07	<i>Start 2 level</i>	REAL	16	-	-	50.00%
79.08	<i>Start 3 level</i>	REAL	16	-	-	60.00%
79.09	<i>Start 4 level</i>	REAL	16	-	-	65.00%
79.10	<i>Start 5 level</i>	REAL	16	-	-	70.00%
79.11	<i>Start 6 level</i>	REAL	16	-	-	75.00%
79.12	<i>Start 7 level</i>	REAL	16	-	-	80.00%
79.13	<i>Start 8 level</i>	REAL	16	-	-	85.00%
79.14	<i>High level</i>	REAL	16	-	-	90.00%
79.15	<i>High switch</i>	Bit pointer	32	-	-	<i>Not used</i>
79.16	<i>Start stop delay</i>	UINT32	16	0...3600	s	5 s
79.17	<i>Random coef</i>	REAL	16	0...10	%	0.0%
79.18	<i>Normal speed</i>	REAL	16	0...32767	rpm	1300 rpm
79.19	<i>High speed</i>	REAL	16	0...32767	rpm	1500 rpm
<b>80 Flow calculation</b>						
80.01	<i>Flow calc mode</i>	enum	16	0...3	-	<i>Not used</i>
80.02	<i>Pump inlet sel</i>	Val pointer	32	-	-	<i>Zero</i>
80.03	<i>Pump outlet sel</i>	Val pointer	32	-	-	<i>Zero</i>
80.04	<i>HQ curve Q1</i>	REAL	16	0...32767	m <sup>3</sup> /h	0.00 m <sup>3</sup> /h
80.05	<i>HQ curve H1</i>	REAL	16	0...32767	m	0.00 m
80.06	<i>HQ curve Q2</i>	REAL	16	0...32767	m <sup>3</sup> /h	0.00 m <sup>3</sup> /h
80.07	<i>HQ curve H2</i>	REAL	16	0...32767	m	0.00 m
80.08	<i>HQ curve Q3</i>	REAL	16	0...32767	m <sup>3</sup> /h	0.00 m <sup>3</sup> /h
80.09	<i>HQ curve H3</i>	REAL	16	0...32767	m	0.00 m
80.10	<i>HQ curve Q4</i>	REAL	16	0...32767	m <sup>3</sup> /h	0.00 m <sup>3</sup> /h
80.11	<i>HQ curve H4</i>	REAL	16	0...32767	m	0.00 m
80.12	<i>HQ curve Q5</i>	REAL	16	0...32767	m <sup>3</sup> /h	0.00 m <sup>3</sup> /h
80.13	<i>HQ curve H5</i>	REAL	16	0...32767	m	0.00 m
80.14	<i>PQ curve P1</i>	REAL	16	0...32767	kW	0.00 kW
80.15	<i>PQ curve Q1</i>	REAL	16	0...32767	m <sup>3</sup> /h	0.00 m <sup>3</sup> /h
80.16	<i>PQ curve P2</i>	REAL	16	0...32767	kW	0.00 kW
80.17	<i>PQ curve Q2</i>	REAL	16	0...32767	m <sup>3</sup> /h	0.00 m <sup>3</sup> /h

No.	Name	Type	Data len.	Range	Unit	Default (Factory def macro)
80.18	<i>PQ curve P3</i>	REAL	16	0...32767	kW	0.00 kW
80.19	<i>PQ curve Q3</i>	REAL	16	0...32767	m <sup>3</sup> /h	0.00 m <sup>3</sup> /h
80.20	<i>PQ curve P4</i>	REAL	16	0...32767	kW	0.00 kW
80.21	<i>PQ curve Q4</i>	REAL	16	0...32767	m <sup>3</sup> /h	0.00 m <sup>3</sup> /h
80.22	<i>PQ curve P5</i>	REAL	16	0...32767	kW	0.00 kW
80.23	<i>PQ curve Q5</i>	REAL	16	0...32767	m <sup>3</sup> /h	0.00 m <sup>3</sup> /h
80.24	<i>HQ PQ brk point</i>	REAL	16	0...32767	m	0.00 m
80.25	<i>Pump inlet diam</i>	REAL	16	0...32767	m	0.00 m
80.26	<i>Pump outlet diam</i>	REAL	16	0...32767	m	0.00 m
80.27	<i>Sensors hgt diff</i>	REAL	16	0...32767	m	0.00 m
80.28	<i>Pump nom speed</i>	REAL	16	0...32767	rpm	1500 rpm
80.29	<i>Density</i>	REAL	16	0...32767	kg/m <sup>3</sup>	1000.00 kg/m <sup>3</sup>
80.30	<i>Efficiency</i>	REAL	16	0...100	%	100.00%
80.31	<i>Flow calc gain</i>	REAL	16	0...32767	-	1.00
80.32	<i>Calc low sp</i>	REAL	16	0...32767	rpm	0 rpm
80.33	<i>Sum flow reset</i>	enum	16	0...1	-	<i>No</i>
<b>81 Pump protection</b>						
81.01	<i>Inlet prot ctrl</i>	enum	16	0...3	-	<i>Not used</i>
81.02	<i>AI measure inlet</i>	Val pointer	32	-	-	<i>AI1 scaled</i>
81.03	<i>AI in low level</i>	REAL	16	0...32767	bar	0.00 bar
81.04	<i>Very low ctrl</i>	enum	16	0...3	-	<i>Not sel</i>
81.05	<i>AI in very low</i>	REAL	16	0...32767	bar	0.00 bar
81.06	<i>DI status inlet</i>	Bit pointer	32	-	-	<i>Not used</i>
81.07	<i>Inlet ctrl dly</i>	UINT32	16	0...600	s	0 s
81.08	<i>Inlet forced ref</i>	REAL	16	0...32767	rpm	0.0 rpm
81.09	<i>Outlet prot ctrl</i>	enum	16	0...3	-	<i>Not used</i>
81.10	<i>AI meas outlet</i>	Val pointer	32	-	-	<i>AI1 scaled</i>
81.11	<i>AI out hi level</i>	REAL	16	0...32767	bar	0.00 bar
81.12	<i>Very high ctrl</i>	enum	16	0...3	-	<i>Not sel</i>
81.13	<i>AI out very high</i>	REAL	16	0...32767	bar	0.00 bar
81.14	<i>DI status outlet</i>	Bit pointer	32	-	-	<i>Not used</i>
81.15	<i>Outlet ctr dly</i>	UINT32	16	0...600	s	0 s
81.16	<i>Outlet force ref</i>	REAL	16	0...32767	rpm	0.0 rpm
81.17	<i>Protect dec time</i>	UINT32	32	0...18000	s	0 s
81.18	<i>Flow source sel</i>	Val pointer	32	-	-	<i>Flow act</i>
81.19	<i>Flow max prot</i>	enum	16	0...2	-	<i>Not sel</i>
81.20	<i>Flow max level</i>	REAL	16	0...32767	m <sup>3</sup> /h	0.00 m <sup>3</sup> /h
81.21	<i>Flow min prot</i>	enum	16	0...2	-	<i>Not sel</i>
81.22	<i>Flow min level</i>	REAL	16	0...32767	m <sup>3</sup> /h	0.00 m <sup>3</sup> /h
81.23	<i>Flow ctrl delay</i>	UINT32	16	0...12600	s	0 s

### 332 Additional parameter data

No.	Name	Type	Data len.	Range	Unit	Default (Factory def macro)
81.24	<i>Flow check delay</i>	UINT32	16	0...12600	s	0 s
81.25	<i>Appl prot ctrl</i>	enum	16	0...2	-	<i>Not used</i>
81.26	<i>Prof limit</i>	REAL	16	0...32767	%	0.00%
81.27	<i>Prof limit dly</i>	INT32	32	0...35791394.1	h	0.00 h
81.28	<i>Pipefill enable</i>	Bit pointer	32	-	-	<i>Not used</i>
81.29	<i>Pipefill step</i>	UINT32	16	0...32767	rpm	50 rpm
81.30	<i>Req act change</i>	REAL	16	0...100	%	0.00%
81.31	<i>Act change delay</i>	UINT32	16	0...100	s	3 s
81.32	<i>Pid enable dev</i>	REAL	16	0...100	%	10.00%
81.33	<i>Pid enb dev dly</i>	UINT32	16	0...12600	s	1 s
81.34	<i>Pipefill timeout</i>	UINT32	16	0...12600	s	1200 s
81.35	<i>Pipefill flt ctr</i>	enum	16	0...2	-	<i>Activate PID</i>
<b>82 Pump cleaning</b>						
82.01	<i>Pump clean trig</i>	Pb	16	0b0000000000... 0b1111111111	-	0b0000100000
82.02	<i>First Step</i>	REAL	16	0...100	%	100.0%
82.03	<i>Second Step</i>	REAL	16	0...100	%	80.0%
82.04	<i>Off time</i>	UINT32	16	0...1000	s	5 s
82.05	<i>First Step Time</i>	UINT32	16	0...1000	s	10 s
82.06	<i>Second Step Time</i>	UINT32	16	0...1000	s	0 s
82.07	<i>Time trig</i>	INT32	32	0...35791394.1	h	24.00 h
82.08	<i>Nbr of steps</i>	UINT32	32	0...2147483647	-	3
82.09	<i>Supervis source</i>	Val pointer	32	-	-	<i>Current %</i>
82.10	<i>Supervis limit</i>	REAL	16	0...32767	-	105.0
82.11	<i>Cleaning delay</i>	UINT32	16	0...600	s	10 s
82.12	<i>Trig pointer</i>	Bit pointer	16	-	-	<i>Not used</i>
82.13	<i>Clean max ctrl</i>	enum	16	0...2	-	<i>Alarm</i>
82.14	<i>Clean max number</i>	UINT32	32	0...30	-	5
82.15	<i>Clean max period</i>	INT32	32	0...35791394.1	h	1.00 h
82.16	<i>Clean step acc</i>	UINT32	32	0...32767	s	1 s
82.17	<i>Clean step dec</i>	UINT32	32	0...32767	s	1 s
<b>83 Energy monitoring</b>						
83.01	<i>Energy mon mode</i>	enum	16	0...3	-	<i>Not used</i>
83.02	<i>Mon period</i>	INT32	32	0...35791394.1	h	0.00 h
83.03	<i>kWh limit</i>	UINT32	32	0...2147483647	kWh	0 kWh
83.04	<i>Mon tolerance</i>	UINT32	32	0...2147483647	kWh	0 kWh
83.05	<i>Energy mon ctrl</i>	enum	16	0...1	-	<i>Not sel</i>
83.06	<i>Energy reset</i>	enum	16	0...2	-	<i>No</i>
83.07	<i>Date alarm ctrl</i>	enum	16	0...1	-	<i>Not sel</i>
<b>94 Ext IO conf</b>						
94.01	<i>Ext IO1 sel</i>	Val pointer	32	0...4	-	<i>None</i>

No.	Name	Type	Data len.	Range	Unit	Default (Factory def macro)
<b>95 Hw configuration</b>						
95.01	<i>Ctrl boardSupply</i>	enum	16	0...1	-	<i>Internal 24V</i>
95.03	<i>Temp inu ambient</i>	INT32	16	0...55	°C	40 °C
<b>97 User motor par</b>						
97.01	<i>Use given params</i>	enum	16	0...1	-	<i>NoUserPars</i>
97.02	<i>Rs user</i>	REAL24	32	0...0.5	p.u.	0.00000 p.u.
97.03	<i>Rr user</i>	REAL24	32	0...0.5	p.u.	0.00000 p.u.
97.04	<i>Lm user</i>	REAL24	32	0...10	p.u.	0.00000 p.u.
97.05	<i>SigmaL user</i>	REAL24	32	0...1	p.u.	0.00000 p.u.
97.06	<i>Ld user</i>	REAL24	32	0...10	p.u.	0.00000 p.u.
97.07	<i>Lq user</i>	REAL24	32	0...10	p.u.	0.00000 p.u.
97.08	<i>Pm flux user</i>	REAL24	32	0...2	p.u.	0.00000 p.u.
97.09	<i>Rs user SI</i>	REAL24	32	0...100	ohm	0.00000 Ohm
97.10	<i>Rr user SI</i>	REAL24	32	0...100	ohm	0.00000 Ohm
97.11	<i>Lm user SI</i>	REAL24	32	0...100000	mH	0.00 mH
97.12	<i>SigL user SI</i>	REAL24	32	0...100000	mH	0.00 mH
97.13	<i>Ld user SI</i>	REAL24	32	0...100000	mH	0.00 mH
97.14	<i>Lq user SI</i>	REAL24	32	0...100000	mH	0.00 mH
<b>99 Start-up data</b>						
99.01	<i>Language</i>	enum	16	-	-	<i>English</i>
99.04	<i>Motor type</i>	enum	16	-	-	<i>AM</i>
99.05	<i>Motor ctrl mode</i>	enum	16	0...1	-	<i>DTC</i>
99.06	<i>Mot nom current</i>	REAL	32	0...6400	A	0.0 A
99.07	<i>Mot nom voltage</i>	REAL	32	$1/6 \dots 2 \times U_N$	V	0.0 V
99.08	<i>Mot nom freq</i>	REAL	32	5...500	Hz	0.0 Hz
99.09	<i>Mot nom speed</i>	REAL	32	0...30000	rpm	0 rpm
99.10	<i>Mot nom power</i>	REAL	32	0...10000	kW or hp	0.00 kW
99.11	<i>Mot nom cosfii</i>	REAL24	32	0...1	-	0.00
99.12	<i>Mot nom torque</i>	INT32	32	0...2147483.647	N•m	0.000 N•m
99.13	<i>IDrun mode</i>	enum	16	0...7	-	<i>No</i>
99.16	<i>Phase inversion</i>	UINT32	32	0...1	-	<i>No</i>





# Fault tracing

---

## What this chapter contains

The chapter lists the alarm (warning) and fault messages including possible causes and corrective actions.

The alarm/fault code is displayed on the control panel of the drive, as well as the DriveStudio PC tool. An alarm or a fault message indicates abnormal drive status. Most alarm and fault causes can be identified and corrected using the information in this chapter. If not, an ABB representative should be contacted.

In this chapter, the alarms and faults are sorted by the four-digit code. The hexadecimal code in brackets that follows the alarm/fault message is for fieldbus communication.

## Safety



---

**WARNING!** Only qualified electricians are allowed to maintain the drive. The *Safety Instructions* on the first pages of the appropriate hardware manual must be read before you start working with the drive.

---

## How to reset

The drive can be reset either by pressing the RESET key on the control panel or PC tool, or by switching the supply voltage off for a while. When the fault has been removed, the motor can be restarted.

A fault can also be reset from an external source selected by parameter [10.10 Fault reset sel.](#)

---

## Fault history

When a fault is detected, it is stored in the fault logger with a time stamp. The fault history stores information on the 16 latest faults of the drive. Three of the latest faults are stored at the beginning of a power switch-off.

Parameters [08.01 Active fault](#) and [08.02 Last fault](#) store the fault codes of the most recent faults. Selected active faults are shown by [08.20 Pump fault word](#).

Alarms can be monitored via alarm words [08.05 Alarm logger1](#) ... [08.18 Alarm word4](#) and [08.21 Pump alarm word](#). Alarm information is lost at power switch-off or fault reset.

## Alarm messages generated by the drive

Code	Alarm (fieldbus code), other information	Cause	What to do
2003	SAFE TORQUE OFF (0xFF7A) <a href="#">08.05 Alarm logger1</a> b3 Programmable alarm: <a href="#">30.07 Sto diagnostic</a>	Safe torque off function is active, i.e. safety circuit signal(s) connected to connector XSTO is lost.	Check safety circuit connections. For more information, see appropriate drive hardware manual, description of parameter <a href="#">30.07</a> (page <a href="#">208</a> ), and <i>Application guide - Safe torque off function for ACSM1, ACS850 and ACQ810 drives</i> (3AFE68929814 [English]).
2004	STO MODE CHANGE (0xFF7A) <a href="#">08.05 Alarm logger1</a> b4	Error in changing Safe torque off supervision, i.e. parameter <a href="#">30.07 Sto diagnostic</a> setting could not be changed to value <i>Alarm</i> .	Contact your local ABB representative.
2005	MOTOR TEMPERATURE (0x4310) <a href="#">08.05 Alarm logger1</a> b5 Programmable alarm: <a href="#">31.01 Mot temp1 prot</a>	Estimated motor temperature (based on motor thermal model) has exceeded alarm limit defined by parameter <a href="#">31.03 Mot temp1 almLim</a> .	Check motor ratings and load. Let motor cool down. Ensure proper motor cooling: Check cooling fan, clean cooling surfaces, etc. Check value of alarm limit. Check motor thermal model settings (parameters <a href="#">31.09</a> ... <a href="#">31.14</a> ).
		Measured motor temperature has exceeded alarm limit defined by parameter <a href="#">31.03 Mot temp1 almLim</a> .	Check that actual number of sensors corresponds to value set by parameter <a href="#">31.02 Mot temp1 src</a> . Check motor ratings and load. Let motor cool down. Ensure proper motor cooling: Check cooling fan, clean cooling surfaces, etc. Check value of alarm limit.
2006	EMERGENCY OFF (0xF083) <a href="#">08.05 Alarm logger1</a> b6	Drive has received emergency OFF2 command.	To restart drive, activate Run enable signal (source selected by parameter <a href="#">10.11 Run enable</a> ) and start drive.
2007	RUN ENABLE (0xFF54) <a href="#">08.05 Alarm logger1</a> b7	No Run enable signal is received.	Check setting of parameter <a href="#">10.11 Run enable</a> . Switch signal on (e.g. in the fieldbus Control Word) or check wiring of selected source.



Code	Alarm (fieldbus code), other information	Cause	What to do
2008	MOTOR ID-RUN (0xFF84) <a href="#">08.05 Alarm logger1</a> b8	Motor identification run is on.	This alarm belongs to normal start-up procedure. Wait until drive indicates that motor identification is completed.
		Motor identification is required.	This alarm belongs to normal start-up procedure. Select how motor identification should be performed, parameter <a href="#">99.13 IDrun mode</a> . Start identification routines by pressing Start key.
2009	EMERGENCY STOP (0xF081) <a href="#">08.05 Alarm logger1</a> b9	Drive has received emergency stop command (OFF3).	Check that it is safe to continue operation. Return emergency stop push button to normal position (or adjust the fieldbus Control Word accordingly). Restart drive.
2013	DEVICE OVERTEMP (0x4210) <a href="#">08.05 Alarm logger1</a> b13	Measured drive temperature has exceeded internal alarm limit.	Check ambient conditions. Check air flow and fan operation. Check heatsink fins for dust pick-up. Check motor power against unit power.
2014	INTBOARD OVERTEMP (0x7182) <a href="#">08.05 Alarm logger1</a> b14	Interface board (between power unit and control unit) temperature has exceeded internal alarm limit.	Let drive cool down. Check for excessive ambient temperature. Check for cooling fan failure. Check for obstructions in the air flow. Check the dimensioning and cooling of the cabinet.
2017	FIELDBUS COMM (0x7510) <a href="#">08.06 Alarm logger2</a> b1 Programmable alarm: <a href="#">50.02 Comm loss func</a>	Cyclical communication between drive and fieldbus adapter module or between PLC and fieldbus adapter module is lost.	Check status of fieldbus communication. See appropriate User's Manual of fieldbus adapter module. Check settings of parameter group <a href="#">50 Fieldbus</a> . Check cable connections. Check if communication master is able to communicate.
2018	PANEL CTRL LOSS (0x5300) <a href="#">08.06 Alarm logger2</a> b2 Programmable alarm: <a href="#">30.03 Panel ctrl loss</a>	Control panel or PC tool selected as active control location for drive has ceased communicating.	Check PC tool or control panel connection. Check control panel connector. Replace control panel in mounting platform.
2019	AI SUPERVISION (0x8110) <a href="#">08.06 Alarm logger2</a> b3 Programmable alarm: <a href="#">13.32 AI superv func</a>	An analog input has reached limit defined by parameter <a href="#">13.33 AI superv cw</a> .	Check analog input source and connections. Check analog input minimum and maximum limit settings.
2020	FB PAR CONF (0x6320) <a href="#">08.06 Alarm logger2</a> b4	The drive does not have a functionality requested by PLC, or requested functionality has not been activated.	Check PLC programming. Check settings of parameter group <a href="#">50 Fieldbus</a> .
2021	NO MOTOR DATA (0x6381) <a href="#">08.06 Alarm logger2</a> b5	Parameters in group 99 have not been set.	Check that all the required parameters in group 99 have been set.

### 338 Fault tracing

Code	Alarm (fieldbus code), other information	Cause	What to do
2035	PS COMM (0x5480) <a href="#">08.07 Alarm logger3</a> b3	Communication errors detected between the JCU Control Unit and the power unit of the drive.	Check the connections between the JCU Control Unit and the power unit.
2036	RESTORE (0x6300) <a href="#">08.07 Alarm logger3</a> b4	Restoration of backed-up parameters failed.	Repeat the restore procedure. Use another back-up file, if possible. If the problem persists, contact your local ABB representative.
2037	CUR MEAS CALIBRATION (0x2280) <a href="#">08.07 Alarm logger3</a> b5	Current measurement calibration will occur at next start.	Informative alarm.
2039	EARTH FAULT (0x2330) <a href="#">08.07 Alarm logger3</a> b7 Programmable alarm: <a href="#">30.05 Earth fault</a>	Drive has detected load unbalance typically due to earth fault in motor or motor cable.	Check there are no power factor correction capacitors or surge absorbers in motor cable. Check for an earth fault in motor or motor cables by measuring the insulation resistances of motor and motor cable. If no earth fault can be detected, contact your local ABB representative.
2040	AUTORESET (0x6080) <a href="#">08.07 Alarm logger3</a> b8	A fault is to be autoreset.	Informative alarm. See parameter group <a href="#">32 Automatic reset</a> .
2041	MOTOR NOM VALUE (0x6383) <a href="#">08.07 Alarm logger3</a> b9	The motor configuration parameters are set incorrectly.	Check the settings of the motor configuration parameters in group 99.
		The drive is not dimensioned correctly.	Check that the drive is sized correctly for the motor.
2043	STALL (0x7121) <a href="#">08.07 Alarm logger3</a> b11 Programmable alarm: <a href="#">30.09 Stall function</a>	Motor is operating in stall region because of e.g. excessive load or insufficient motor power.	Check motor load and drive ratings. Check fault function parameters.
2044	LOAD CURVE (0x2312) <a href="#">08.07 Alarm logger3</a> b12 Programmable alarm: <a href="#">34.01 Overload func</a> / <a href="#">34.02 Underload func</a>	Overload or underload limit has been exceeded.	Check the settings of the parameters in group <a href="#">34 User load curve</a> .
2045	LOAD CURVE PAR (0x6320) <a href="#">08.07 Alarm logger3</a> b13	The load curve has been incorrectly or inconsistently defined.	Check the settings of the parameters in group <a href="#">34 User load curve</a> .
2046	U/f-curve par (0x6320) <a href="#">08.07 Alarm logger3</a> b14	The U/f (voltage/frequency) curve has been incorrectly or inconsistently defined.	Check the settings of the parameters in group <a href="#">38 Flux ref</a> .
2048	OPTION COMM LOSS (0x7000) <a href="#">08.08 Alarm logger4</a> b0	Communication between drive and option module (FEN-xx and/or FIO-xx) is lost.	Check that option modules are properly connected to Slot 1 (or) Slot 2. Check that option modules or Slot 1/2 connectors are not damaged. To determine whether module or connector is damaged: Test each module individually in Slot 1 and Slot 2.

Code	Alarm (fieldbus code), other information	Cause	What to do
2049	MOTOR TEMP2 (0x4313) <a href="#">08.08 Alarm logger4</a> b2 Programmable alarm: <a href="#">31.05 Mot temp2 prot</a>	Estimated motor temperature (based on motor thermal model) has exceeded alarm limit defined by parameter <a href="#">31.07 Mot temp2 almLim</a> .	Check motor ratings and load. Let motor cool down. Ensure proper motor cooling: Check cooling fan, clean cooling surfaces, etc. Check value of alarm limit. Check motor thermal model settings (parameters <a href="#">31.09...31.14</a> ).
		Measured motor temperature has exceeded alarm limit defined by parameter <a href="#">31.07 Mot temp2 almLim</a> .	Check that actual number of sensors corresponds to value set by parameter <a href="#">31.06 Mot temp2 src</a> . Check motor ratings and load. Let motor cool down. Ensure proper motor cooling: Check cooling fan, clean cooling surfaces, etc. Check value of alarm limit.
2050	IGBT OVERLOAD (0x5482) <a href="#">08.08 Alarm logger4</a> b3	Excessive IGBT junction to case temperature. This fault protects the IGBT(s) and can be activated by a short circuit in the motor cable.	Check motor cable.
2051	IGBT TEMP (0x4210) <a href="#">08.08 Alarm logger4</a> b4	Drive IGBT temperature is excessive.	Check ambient conditions. Check air flow and fan operation. Check heatsink fins for dust pick-up. Check motor power against drive power.
2052	COOLING (0x4290) <a href="#">08.08 Alarm logger4</a> b5	Drive module temperature is excessive.	Check ambient temperature. If it exceeds 40 °C (104 °F), ensure that load current does not exceed derated load capacity of drive. See appropriate <i>Hardware Manual</i> . Check drive module cooling air flow and fan operation. Check inside of cabinet and heatsink of drive module for dust pick-up. Clean whenever necessary.
2053	MENU CHG PASSWORD REQ (0x6F81)	Loading a parameter listing requires a password.	Enter password at parameter <a href="#">16.03 Pass code</a> .
2054	MENU CHANGED (0x6F82) <a href="#">08.08 Alarm logger4</a> b6	A different parameter listing is being loaded.	Informative alarm.

### 340 Fault tracing

Code	Alarm (fieldbus code), other information	Cause	What to do
2055	DEVICE CLEAN (0x5080)	Maintenance counter alarm.	See parameter group <a href="#">44 Maintenance</a> . <b>Note:</b> Any maintenance counter alarm sets bit 8 of <a href="#">08.08 Alarm logger4</a> .
2056	COOLING FAN (0x5081)		
2057	ADD COOLING (0x5082)		
2058	CABINET FAN (0x5083)		
2059	DC CAPACITOR (0x5084)		
2060	MOTOR BEARING (0x738C)		
2061	MAIN CONTACTOR (0x548D)		
2062	RELAY OUTPUT SW (0x548E)		
2063	MOTOR START COUNT (0x6180)		
2064	POWER UP COUNT (0x6181)		
2065	DC CHARGE COUNT (0x6182)		
2066	ONTIME1 ALARM (0x5280)		
2067	ONTIME2 ALARM (0x5281)		
2068	EDGE1 ALARM (0x5282)		
2069	EDGE2 ALARM (0x5283)		
2070	VALUE1 ALARM (0x5284)		
2071	VALUE2 ALARM (0x5285)		
2072	DC NOT CHARGED (0x3250) <a href="#">08.08 Alarm logger4</a> b9	The voltage of the intermediate DC circuit has not yet risen to operating level.	Wait for the DC voltage to rise.
2073	AUTOTUNE FAILED (0x8481) <a href="#">08.08 Alarm logger4</a> b10	Speed controller autotune routine did not finish successfully.	See parameter <a href="#">23.20 PI tune mode</a> .
2074	START INTERLOCK (0xF082) <a href="#">08.08 Alarm logger4</a> b11	No Start interlock signal received.	Check circuit connected to DIIL input.
2076	TEMP MEAS FAILURE (0x4211) <a href="#">08.08 Alarm logger4</a> b7	Problem with internal temperature measurement of the drive.	Contact your local ABB representative.

Code	Alarm (fieldbus code), other information	Cause	What to do
2077	EFB COMM LOSS (0x7540) <a href="#">08.08 Alarm logger4</a> b12	Embedded fieldbus interface has been taken into use, and there is a communication break between the drive and the master station.	Check: <ul style="list-style-type: none"> <li>• selection of the parameter which enables/disables EFB communication (<a href="#">58.01 Protocol enable</a>)</li> <li>• EFB connection at terminal XD2D on the JCON board</li> <li>• status of the fieldbus master (online/offline)</li> <li>• settings of the communication supervision function (parameter <a href="#">58.09 Comm loss action</a>).</li> </ul>
2081	AO CALIBRATION (0x7380)	Analog output calibration has failed.	Check that the analog output to be calibrated is connected to the corresponding analog input (AO1 to AI1, AO2 to AI2). See the description of parameter <a href="#">15.30 AO calibration</a> . Check that the analog input has been set to current using the jumper on the control unit. Refer to the Hardware manual of the drive for the settings. Check the functioning of the analog output and input.
2201	PIPEFILL TIMEOUT (0xC000) <a href="#">08.09 Alarm logger5</a> b0 <a href="#">08.21 Pump alarm word</a> b9	Maximum allowed time for the Pipefill function exceeded.	Check the pump system. Check parameters <a href="#">81.28</a> ... <a href="#">81.35</a> .
2202	MIN FLOW (0xC001) <a href="#">08.09 Alarm logger5</a> b1 <a href="#">08.21 Pump alarm word</a> b0	Measured flow below minimum limit.	Check the pump system for reasons such as leaks that might cause a loss of measured flow. Check parameters <a href="#">81.18</a> ... <a href="#">81.24</a> .
2203	MAX FLOW (0xC002) <a href="#">08.09 Alarm logger5</a> b2 <a href="#">08.21 Pump alarm word</a> b1	Measured flow above maximum limit.	Check the pump system for reasons that might cause an increase in measured flow. Check parameters <a href="#">81.18</a> ... <a href="#">81.24</a> .
2204	LOW PRESSURE (0xC003) <a href="#">08.09 Alarm logger5</a> b3 <a href="#">08.21 Pump alarm word</a> b2	Pressure at pump inlet too low.	Check for a closed valve on the inlet side of the pump. Check piping for leaks.
2205	HIGH PRESSURE (0xC004) <a href="#">08.09 Alarm logger5</a> b4 <a href="#">08.21 Pump alarm word</a> b3	Pressure at pump outlet too high.	Check piping for blocks.
2206	VERY LOW PRESS (0xC005) <a href="#">08.09 Alarm logger5</a> b5 <a href="#">08.21 Pump alarm word</a> b4	Pressure at pump inlet too low.	Check for a closed valve on the inlet side of the pump. Check piping for leaks.
2207	VERY HIGH PRESS (0xC006) <a href="#">08.09 Alarm logger5</a> b6 <a href="#">08.21 Pump alarm word</a> b5	Pressure at pump outlet too high.	Check piping for blocks.
2208	PROFILE HIGH (0xC007) <a href="#">08.09 Alarm logger5</a> b7 <a href="#">08.21 Pump alarm word</a> b6	Application profile protection limit exceeded (see parameters <a href="#">81.25</a> ... <a href="#">81.27</a> ).	Check the piping for leaks. Check the general condition of the components of the pumping station.

## 342 Fault tracing

Code	Alarm (fieldbus code), other information	Cause	What to do
2209	MAX CLEANINGS (0xC008) <a href="#">08.09 Alarm logger5</a> b8 <a href="#">08.21 Pump alarm word</a> b7	Maximum number of cleaning sequences exceeded (see parameter group <a href="#">82 Pump cleaning</a> ).	Check for reasons that might have had an increasing effect on the monitored signal (parameter <a href="#">82.09</a> ). For example, increased viscosity of the fluid, or faulty pump bearings may increase the current drawn by the motor, and trigger the cleaning sequence more frequently.
2210	ALL PUMPS INLOCKD (0xC009) <a href="#">08.09 Alarm logger5</a> b9 <a href="#">08.21 Pump alarm word</a> b10	All interlock signals are off, indicating no pumps are available.	Check the interlock settings in parameter group <a href="#">78 Pump autochange</a> . Check that the pumps are switched on. Check the interlock wiring from the pumps.
2211	ENERGY LIMIT (0xC00A) <a href="#">08.09 Alarm logger5</a> b10 <a href="#">08.21 Pump alarm word</a> b11	Energy consumption limit exceeded (see parameter group <a href="#">83 Energy monitoring</a> ).	Check for reasons for increased energy consumption.
2212	DATE WRONG (0xC00B) <a href="#">08.09 Alarm logger5</a> b11 <a href="#">08.21 Pump alarm word</a> b12	Date has not been set.	Set the date and time (page <a href="#">37</a> ).
2215	BOOSTING (0xC00E) <a href="#">08.09 Alarm logger5</a> b14 <a href="#">08.21 Pump alarm word</a> b15	Sleep boost is active.	Informative alarm.
2216	PIPE FILLING (0xC00F) <a href="#">08.09 Alarm logger5</a> b15 <a href="#">08.21 Pump alarm word</a> b16	The soft pipefill function is being performed.	Informative alarm.
2217	NO MORE PUMPS (0xC010) <a href="#">08.10 Alarm logger6</a> b0 <a href="#">08.21 Pump alarm word</a> b17	No further pumps are available for starting.	Check that all appropriate pumps are switched on.
2218	CLEANING (0xC011) <a href="#">08.10 Alarm logger6</a> b1 <a href="#">08.21 Pump alarm word</a> b8	A pump cleaning sequence is in progress.	Informative alarm.
2219	AUTOCHANGE (0xC012) <a href="#">08.10 Alarm logger6</a> b2 <a href="#">08.21 Pump alarm word</a> b18	The Autochange function is being performed.	Informative alarm.
2220	SLEEPING (0xC013) <a href="#">08.10 Alarm logger6</a> b3 <a href="#">08.21 Pump alarm word</a> b19	The drive has entered sleep mode.	Informative alarm.
2221	START DELAY (0xC014) <a href="#">08.10 Alarm logger6</a> b4 <a href="#">08.21 Pump alarm word</a> b20	A pump will start after the start delay has elapsed.	Informative alarm.
2222	LC TANK FULL (0xC016) <a href="#">08.10 Alarm logger6</a> b5 <a href="#">08.21 Pump alarm word</a> b23	The level of the liquid in the container is very high (the source selected by parameter <a href="#">79.15 High switch</a> is 1).	Informative alarm.

Code	Alarm (fieldbus code), other information	Cause	What to do
2223	LC TANK EMPTY (0xC017) <i>08.10 Alarm logger6</i> b6 <i>08.21 Pump alarm word</i> b24	The level of the liquid in the container is very low (the source selected by parameter <i>79.04 Low switch</i> is 1).	Informative alarm.
2224	MF MASTER LOST (0xC018) <i>08.10 Alarm logger6</i> b7 <i>08.21 Pump alarm word</i> b21	The drive cannot detect a master on the drive-to-drive link, and is not itself allowed to become master.	Check that there are drives on the drive-to-drive link that are allowed to become master. Check the wiring of the drive-to-drive link.
2225	MF NO SHARED DATA (0xC019) <i>08.10 Alarm logger6</i> b8 <i>08.21 Pump alarm word</i> b25	Shared signals not received.	Check that at least one drive has signal sharing enabled (parameter <i>76.12 Set as source</i> ). Check the status, communication settings and wiring of the drive that is sharing its signals.
2400	SOLUTION ALARM (0x6F80) <i>08.08 Alarm logger4</i> b1 <i>08.18 Alarm word4</i> b1	Alarm generated by custom application program.	Check custom application program.

## Fault messages generated by the drive

Code	Fault (fieldbus code), other information	Cause	What to do
0001	OVERCURRENT (0x2310)	Output current has exceeded internal fault limit.	Check motor load. Check acceleration times in parameter group <a href="#">22 Speed ref ramp</a> . Check motor and motor cable (including phasing and delta/star connection). Check that the start-up data in parameter group 99 corresponds to the motor rating plate. Check that there are no power factor correction capacitors or surge absorbers in motor cable.
0002	DC OVERVOLTAGE (0x3210)	Excessive intermediate circuit DC voltage	Check that overvoltage controller is on, parameter <a href="#">47.01 Overvolt ctrl</a> . Check mains for static or transient overvoltage. Check deceleration time. Use coast-to-stop function (if applicable).
0003	DEVICE OVERTEMP (0x4210)	Measured drive temperature has exceeded internal fault limit.	Check ambient conditions. Check air flow and fan operation. Check heatsink fins for dust pick-up. Check motor power against unit power.
0004	SHORT CIRCUIT (0x2340)	Short-circuit in motor cable(s) or motor	Check motor and motor cable. Check there are no power factor correction capacitors or surge absorbers in motor cable. Check the fault logger for a fault code extension. See appropriate actions for each extension below.
	Extension: 1	Short-circuit in the upper transistor of U-phase.	Contact your local ABB representative.
	Extension: 2	Short-circuit in the lower transistor of U-phase.	
	Extension: 4	Short-circuit in the upper transistor of V-phase.	
	Extension: 8	Short-circuit in the lower transistor of V-phase.	
	Extension: 16	Short-circuit in the upper transistor of W-phase.	
	Extension: 32	Short-circuit in the lower transistor of W-phase.	
0005	DC UNDERVOLTAGE (0x3220)	Intermediate circuit DC voltage is not sufficient due to missing mains phase, blown fuse or rectifier bridge internal fault.	Check mains supply and fuses.



Code	Fault (fieldbus code), other information	Cause	What to do
0006	EARTH FAULT (0x2330) Programmable fault: <a href="#">30.05 Earth fault</a>	Drive has detected load unbalance typically due to earth fault in motor or motor cable.	Check there are no power factor correction capacitors or surge absorbers in motor cable. Check that there is no earth fault in motor or motor cables: - measure insulation resistances of motor and motor cable. If no earth fault can be detected, contact your local ABB representative.
0007	FAN FAULT (0xFF83)	Fan is not able to rotate freely or fan is disconnected. Fan operation is monitored by measuring fan current.	Check fan operation and connection.
0013	CURR MEAS GAIN (0x3183)	Difference between output phase U2 and W2 current measurement gain is too great.	Contact your local ABB representative.
0014	WIRING OR EARTH FAULT (0x3181) Programmable fault: <a href="#">30.08 Wiring or earth</a>	Incorrect input power and motor cable connection, or ground (earth) fault in the motor cable or motor.	Check input power and motor cable connections. Check the insulation resistance of the motor cable and motor.
0015	SUPPLY PHASE (0x3130) Programmable fault: <a href="#">30.06 Suppl phs loss</a>	Intermediate circuit DC voltage is oscillating due to missing input power line phase or blown fuse.	Check input power line fuses. Check for input power supply imbalance.
0016	MOTOR PHASE (0x3182) Programmable fault: <a href="#">30.04 Mot phase loss</a>	Motor circuit fault due to missing motor connection (all three phases are not connected).	Connect motor cable.
0017	ID-RUN FAULT (0xFF84)	Motor ID run is not completed successfully.	Check the fault logger for a fault code extension. See appropriate actions for each extension below.
	Extension: 1	The ID run cannot be completed because the maximum current setting and/or internal current limit of the drive is too low.	Check setting of parameters <a href="#">99.06 Mot nom current</a> and <a href="#">20.05 Maximum current</a> . Make sure that <a href="#">20.05 Maximum current</a> > <a href="#">99.06 Mot nom current</a> . Check that the drive is dimensioned correctly according to the motor.
	Extension: 2	The ID run cannot be completed because the maximum speed setting and/or calculated field weakening point is too low.	Check setting of parameters <a href="#">99.07 Mot nom voltage</a> , <a href="#">99.08 Mot nom freq</a> , <a href="#">99.09 Mot nom speed</a> , <a href="#">20.01 Maximum speed</a> and <a href="#">20.02 Minimum speed</a> . Make sure that <ul style="list-style-type: none"> <li>• <a href="#">20.01 Maximum speed</a> &gt; (0.55 × <a href="#">99.09 Mot nom speed</a>) &gt; (0.50 × synchronous speed),</li> <li>• <a href="#">20.02 Minimum speed</a> ≤ 0, and</li> <li>• supply voltage ≥ (0.66 × <a href="#">99.07 Mot nom voltage</a>).</li> </ul>

Code	Fault (fieldbus code), other information	Cause	What to do
	Extension: 3	The ID run cannot be completed because the maximum torque setting is too low.	Check setting of parameter <a href="#">99.12 Mot nom torque</a> and torque limits defined in parameter group <a href="#">20 Limits</a> . Make sure that the active maximum torque (selected by <a href="#">20.06 Torq lim sel</a> ) > 100%.
	Extension: 4	Current measurement calibration did not finish within reasonable time.	Contact your local ABB representative.
	Extension: 5...8	Internal error.	Contact your local ABB representative.
	Extension: 9	Asynchronous motors only: Acceleration did not finish within reasonable time.	Contact your local ABB representative.
	Extension: 10	Asynchronous motors only: Deceleration did not finish within reasonable time.	Contact your local ABB representative.
	Extension: 11	Asynchronous motors only: Speed dropped to zero during ID run.	Contact your local ABB representative.
	Extension: 14...16	Internal error.	Contact your local ABB representative.
0018	CURR U2 MEAS (0x3184)	Measured offset error of U2 output phase current measurement is too great. (Offset value is updated during current calibration.)	Contact your local ABB representative.
0019	CURR V2 MEAS (0x3185)	Measured offset error of V2 output phase current measurement is too great. (Offset value is updated during current calibration.)	Contact your local ABB representative.
0020	CURR W2 MEAS (0x3186)	Measured offset error of W2 output phase current measurement is too great. (Offset value is updated during current calibration.)	Contact your local ABB representative.
0021	STO1 LOST (0x8182)	Safe torque off function is active, i.e. safety circuit signal 1 connected between XSTO:1 and XSTO:3 is lost.	Check safety circuit connections. For more information, see appropriate drive hardware manual, description of parameter <a href="#">30.07</a> (page <a href="#">208</a> ), and <i>Application guide - Safe torque off function for ACSM1, ACS850 and ACQ810 drives</i> (3AFE68929814 [English]).
0022	STO2 LOST (0x8183)	Safe torque off function is active, i.e. safety circuit signal 2 connected between XSTO:2 and XSTO:4 is lost.	
0023	STO MODE CHANGE (0xFF7A)	Error in changing Safe torque off supervision, i.e. parameter <a href="#">30.07 Sto diagnostic</a> setting could not be changed to value <i>Fault</i> .	Contact your local ABB representative.

Code	Fault (fieldbus code), other information	Cause	What to do
0024	INTBOARD OVERTEMP (0x7182)	Interface board (between power unit and control unit) temperature has exceeded internal fault limit.	Let drive cool down. Check for excessive ambient temperature. Check for cooling fan failure. Check for obstructions in the air flow. Check the dimensioning and cooling of the cabinet.
0027	PU LOST (0x5400)	Connection between the JCU Control Unit and the power unit of the drive is lost.	Check the connections between the JCU Control Unit and the power unit. Check setting of parameter <a href="#">95.01 Ctrl boardSupply</a> .
0028	PS COMM (0x5480)	Communication errors detected between the JCU Control Unit and the power unit of the drive.	Check the connections between the JCU Control Unit and the power unit.
0030	EXTERNAL (0x9000)	Fault in external device. (This information is configured through one of programmable digital inputs.)	Check external devices for faults. Check parameter <a href="#">30.01 External fault</a> setting.
0031	SAFE TORQUE OFF (0xFF7A) Programmable fault: <a href="#">30.07 Sto diagnostic</a>	Safe torque off function is active, i.e. safety circuit signal(s) connected to connector XSTO is lost during start or run, or while drive is stopped and parameter <a href="#">30.07 Sto diagnostic</a> is set to <i>Fault</i> .	Check safety circuit connections. For more information, see appropriate drive hardware manual, and <i>Application guide - Safe torque off function for ACSM1, ACS850 and ACQ810 drives</i> (3AFE68929814 [English]).
0032	OVERSPEED (0x7310)	Motor is turning faster than highest allowed speed.	Check minimum/maximum speed settings, parameters <a href="#">20.01 Maximum speed</a> and <a href="#">20.02 Minimum speed</a> .
0036	PANEL CTRL LOSS (0x5300) Programmable fault: <a href="#">30.03 Panel ctrl loss</a>	Control panel or PC tool selected as active control location for drive has ceased communicating.	Check PC tool or control panel connection. Check control panel connector. Replace control panel in mounting platform.
0037	NVMEM CORRUPTED (0x6320)	Drive internal fault <b>Note:</b> This fault cannot be reset.	Contact your local ABB representative.
0038	OPTION COMM LOSS (0x7000)	Communication between drive and option module (FIO-xx) is lost.	Check that option modules are properly connected to Slot 1 and (or) Slot 2. Check that option modules or Slot 1/2 connectors are not damaged. To determine whether module or connector is damaged: Test each module individually in Slot 1 and Slot 2.
0045	FIELD BUS COMM (0x7510) Programmable fault: <a href="#">50.02 Comm loss func</a>	Cyclical communication between drive and fieldbus adapter module or between PLC and fieldbus adapter module is lost.	Check status of fieldbus communication. See appropriate User's Manual of fieldbus adapter module. Check settings of parameter group <a href="#">50 Fieldbus</a> . Check cable connections. Check if communication master is able to communicate.

## 348 Fault tracing

Code	Fault (fieldbus code), other information	Cause	What to do
0046	FB MAPPING FILE (0x6306)	Drive internal fault	Contact your local ABB representative.
0047	MOTOR OVERTEMP (0x4310) Programmable fault: <a href="#">31.01 Mot temp1 prot</a>	Estimated motor temperature (based on motor thermal model) has exceeded fault limit defined by parameter <a href="#">31.04 Mot temp1 fitLim</a> .	Check motor ratings and load. Let motor cool down. Ensure proper motor cooling: Check cooling fan, clean cooling surfaces, etc. Check value of alarm limit. Check motor thermal model settings (parameters <a href="#">31.09...31.14</a> ).
		Measured motor temperature has exceeded fault limit defined by parameter <a href="#">31.04 Mot temp1 fitLim</a> .  Faulty temperature sensor or sensor wiring.	Check that actual number of sensors corresponds to value set by parameter <a href="#">31.02 Mot temp1 src</a> . Check motor ratings and load. Let motor cool down. Ensure proper motor cooling: Check cooling fan, clean cooling surfaces, etc. Check value of alarm limit. Check the sensor and its wiring.
0049	AI SUPERVISION (0x8110) Programmable fault: <a href="#">13.32 AI superv func</a>	An analog input has reached limit defined by parameter <a href="#">13.33 AI superv cw</a> .	Check analog input source and connections. Check analog input minimum and maximum limit settings.
0055	TECH LIB (0x6382)	Resettable fault generated by a technology library.	Refer to the documentation of the technology library.
0056	TECH LIB CRITICAL (0x6382)	Permanent fault generated by a technology library.	Refer to the documentation of the technology library.
0057	FORCED TRIP (0xFF90)	Generic Drive Communication Profile trip command.	Check PLC status.
0058	FIELDBUS PAR ERROR (0x6320)	The drive does not have a functionality requested by PLC, or requested functionality has not been activated.	Check PLC programming. Check settings of parameter group <a href="#">50 Fieldbus</a> .
0059	STALL (0x7121) Programmable fault: <a href="#">30.09 Stall function</a>	Motor is operating in stall region because of e.g. excessive load or insufficient motor power.	Check motor load and drive ratings. Check fault function parameters.
0060	LOAD CURVE (0x2312) Programmable fault: <a href="#">34.01 Overload func</a> / <a href="#">34.02 Underload func</a>	Overload or underload limit has been exceeded.	Check the settings of the parameters in group <a href="#">34 User load curve</a> .

Code	Fault (fieldbus code), other information	Cause	What to do
0063	MOTOR TEMP2 (0x4313) Programmable fault: <a href="#">31.05 Mot temp2 prot</a>	Estimated motor temperature (based on motor thermal model) has exceeded fault limit defined by parameter <a href="#">31.08 Mot temp2 fitLim</a> .	Check motor ratings and load. Let motor cool down. Ensure proper motor cooling: Check cooling fan, clean cooling surfaces, etc. Check value of alarm limit. Check motor thermal model settings (parameters <a href="#">31.09...31.14</a> ).
		Measured motor temperature has exceeded fault limit defined by parameter <a href="#">31.08 Mot temp2 fitLim</a> .  Faulty temperature sensor or sensor wiring.	Check that actual number of sensors corresponds to value set by parameter <a href="#">31.06 Mot temp2 src</a> . Check motor ratings and load. Let motor cool down. Ensure proper motor cooling: Check cooling fan, clean cooling surfaces, etc. Check value of alarm limit. Check the sensor and its wiring.
0064	IGBT OVERLOAD (0x5482)	Excessive IGBT junction to case temperature. This fault protects the IGBT(s) and can be activated by a short circuit in the motor cable.	Check motor cable.
0065	IGBT TEMP (0x4210)	Drive IGBT temperature is excessive.	Check ambient conditions. Check air flow and fan operation. Check heatsink fins for dust pick-up. Check motor power against drive power.
0066	COOLING (0x4290)	Drive module temperature is excessive.	Check setting of parameter <a href="#">95.03 Temp inu ambient</a> . Check ambient temperature. If it exceeds 40 °C (104 °F), ensure that load current does not exceed derated load capacity of drive. See appropriate <i>Hardware Manual</i> . Check drive module cooling air flow and fan operation. Check inside of cabinet and heatsink of drive module for dust pick-up. Clean whenever necessary.
0067	FPGA ERROR1 (0x5401)	Drive internal fault.	Contact your local ABB representative.
0068	FPGA ERROR2 (0x5402)	Drive internal fault.	Contact your local ABB representative.
0069	ADC ERROR (0x5403)	Drive internal fault.	Contact your local ABB representative.
0070	TEMP MEAS FAILURE (0x4211)	Problem with internal temperature measurement of the drive.	Contact your local ABB representative.

Code	Fault (fieldbus code), other information	Cause	What to do
0071	EFB COMM (0x7540)	Embedded fieldbus interface has been taken into use, and there is a communication break between the drive and the master station.	Check: <ul style="list-style-type: none"> <li>• selection of the parameter which enables/disables EFB communication (<a href="#">58.01 Protocol enable</a>)</li> <li>• EFB connection at terminal XD2D on the JCON board</li> <li>• status of the fieldbus master (online/offline)</li> <li>• settings of the communication supervision function (parameter <a href="#">58.09 Comm loss action</a>).</li> </ul>
0201	T2 OVERLOAD (0x0201)	The drive CPU is overloaded. Firmware time level 2 overload. <b>Note:</b> This fault cannot be reset.	Try to reduce the load. For example, use a lower fieldbus speed, or optimize the application program (e.g. lower time levels). If the problem persists, contact your local ABB representative.
0202	T3 OVERLOAD (0x6100)	The drive CPU is overloaded. Firmware time level 3 overload. <b>Note:</b> This fault cannot be reset.	Try to reduce the load. For example, use a lower fieldbus speed, or optimize the application program (e.g. lower time levels). If the problem persists, contact your local ABB representative.
0203	T4 OVERLOAD (0x6100)	The drive CPU is overloaded. Firmware time level 4 overload. <b>Note:</b> This fault cannot be reset.	Try to reduce the load. For example, use a lower fieldbus speed, or optimize the application program (e.g. lower time levels). If the problem persists, contact your local ABB representative.
0204	T5 OVERLOAD (0x6100)	The drive CPU is overloaded. Firmware time level 5 overload. <b>Note:</b> This fault cannot be reset.	Try to reduce the load. For example, use a lower fieldbus speed, or optimize the application program (e.g. lower time levels). If the problem persists, contact your local ABB representative.
0205	A1 OVERLOAD (0x6100)	Application time level 1 fault <b>Note:</b> This fault cannot be reset.	Contact your local ABB representative.
0206	A2 OVERLOAD (0x6100)	Application time level 2 fault <b>Note:</b> This fault cannot be reset.	Contact your local ABB representative.
0207	A1 INIT FAULT (0x6100)	Application task creation fault <b>Note:</b> This fault cannot be reset.	Reload the application program into the drive. If the problem persists, contact your local ABB representative.
0208	A2 INIT FAULT (0x6100)	Application task creation fault <b>Note:</b> This fault cannot be reset.	Reload the application program into the drive. If the problem persists, contact your local ABB representative.
0209	STACK ERROR (0x6100)	Drive internal fault <b>Note:</b> This fault cannot be reset.	Contact your local ABB representative.
0210	JMU MISSING (0xFF61)	JMU Memory Unit is missing or broken.	Check that the JMU is properly installed. If the problem persists, replace the JMU.

Code	Fault (fieldbus code), other information	Cause	What to do
0301	UFF FILE READ (0x6300)	File read error <b>Note:</b> This fault cannot be reset.	Update the drive firmware. If the problem persists, contact your local ABB representative.
0302	APPL DIR CREATION (0x6100)	Drive internal fault <b>Note:</b> This fault cannot be reset.	Contact your local ABB representative.
0303	FPGA CONFIG DIR (0x6100)	Drive internal fault <b>Note:</b> This fault cannot be reset.	Contact your local ABB representative.
0304	PU RATING ID (0x5483)	Drive internal fault <b>Note:</b> This fault cannot be reset.	Contact your local ABB representative.
0305	RATING DATABASE (0x6100)	Drive internal fault <b>Note:</b> This fault cannot be reset.	Contact your local ABB representative.
0306	LICENSING (0x6100)	Drive internal fault <b>Note:</b> This fault cannot be reset.	Check that the memory unit contains the correct firmware. If the problem persists, contact your local ABB representative.
0307	DEFAULT FILE (0x6100)	Drive internal fault <b>Note:</b> This fault cannot be reset.	Contact your local ABB representative.
0308	APPL FILE PAR CONF (0x6300)	Corrupted application file <b>Note:</b> This fault cannot be reset.	Reload application. If fault is still active, contact your local ABB representative.
0309	APPL LOADING (0x6300)	Application file incompatible or corrupted <b>Note:</b> This fault cannot be reset.	Reload application. If fault is still active, contact your local ABB representative.
	Extension: 8	Template used in the application incompatible with drive firmware.	*Change the template of the application in DriveSPC.
	Extension: 10	Parameters defined in the application conflict with existing drive parameters.	*Check the application for conflicting parameters.
	Extension: 35	Application memory full.	Reduce application size. If fault is still active, contact your local ABB representative.
	Extension: Other	Corrupted application file.	*Reload application. If fault is still active, contact your local ABB representative.
0310	USERSET LOAD (0xFF69)	Loading of user set is not successfully completed because: - requested user set does not exist - user set is not compatible with drive program - drive has been switched off during loading.	Reload.



Code	Fault (fieldbus code), other information	Cause	What to do
0311	USERSET SAVE (0xFF69)	User set is not saved because of memory corruption.	Check the setting of parameter <a href="#">95.01 Ctrl boardSupply</a> . If the fault still occurs, contact your local ABB representative.
0312	UFF OVERSIZE (0x6300)	UFF file is too big.	Contact your local ABB representative.
0313	UFF EOF (0x6300)	UFF file structure failure.	Update the drive firmware. If the problem persists, contact your local ABB representative.
0314	TECH LIB INTERFACE (0x6100)	Incompatible firmware interface <b>Note:</b> This fault cannot be reset.	Check the compatibility of the firmware version. If the problem persists, contact your local ABB representative.
0315	RESTORE FILE (0x630D)	Restoration of backed-up parameters failed.	Contact your local ABB representative.
0316	DAPS MISMATCH (0x5484)	Mismatch between JCU Control Unit firmware and power unit logic versions.	Contact your local ABB representative.
0317	SOLUTION FAULT (0x6200)	Fault generated by function block SOLUTION_FAULT in the solution program.	Check the usage of the SOLUTION_FAULT block in the application program.
0318	MENU HIDING	Menu hiding file missing or corrupted.	Reload application. Contact your local ABB representative.
0401	PIPEFILL TOUT (0xB000) <a href="#">08.20 Pump fault word</a> b7	Maximum allowed time for the Pipefill function exceeded.	Check the pump system. Check parameters <a href="#">81.28...81.35</a> .
0402	MIN FLOW (0xB001) <a href="#">08.20 Pump fault word</a> b0	Measured flow below minimum limit.	Check the pump system for reasons such as leaks that might cause a loss of measured flow. Check parameters <a href="#">81.18...81.24</a> .
0403	MAX FLOW (0xB002) <a href="#">08.20 Pump fault word</a> b1	Measured flow above maximum limit.	Check the pump system for reasons that might cause an increase in measured flow. Check parameters <a href="#">81.18...81.24</a> .
0404	LOW PRESSURE (0xB003) <a href="#">08.20 Pump fault word</a> b2	Pressure at pump inlet too low.	Check for a closed valve on the inlet side of the pump. Check piping for leaks.
0405	HIGH PRESSURE (0xB004) <a href="#">08.20 Pump fault word</a> b3	Pressure at pump outlet too high.	Check piping for blocks.
0406	VERY LOW PRESS (0xB005) <a href="#">08.20 Pump fault word</a> b4	Pressure at pump inlet too low.	Check for a closed valve on the inlet side of the pump. Check piping for leaks.
0407	VERY HIGH PRESS (0xB006) <a href="#">08.20 Pump fault word</a> b5	Pressure at pump outlet too high.	Check piping for blocks.



Code	Fault (fieldbus code), other information	Cause	What to do
0408	MAX CLEANINGS (0xB007) <i>08.20 Pump fault word b6</i>	Maximum number of cleaning sequences exceeded (see parameter group <i>82 Pump cleaning</i> ).	Check for reasons that might have had an increasing effect on the monitored signal (parameter <i>82.09</i> ). For example, increased viscosity of the fluid, or faulty pump bearings may increase the current drawn by the motor, and trigger the cleaning sequence more frequently.
0409	MF MASTER LOST (0xB008) <i>08.20 Pump fault word b8</i>	The drive cannot detect a master on the drive-to-drive link, and is not itself allowed to become master.	Check that there are drives on the drive-to-drive link that are allowed to become master. Check the wiring of the drive-to-drive link.
0410	MF NO SHARED DATA (0xB009) <i>08.20 Pump fault word b9</i>	Shared signals not received.	Check that at least one drive has signal sharing enabled (parameter <i>76.12</i> ). Check the status, communication settings and wiring of the drive that is sharing its signals.
06xx		Faults generated by custom application program.	Check custom application program.





# Control through the embedded fieldbus interface

---

## What this chapter contains

The chapter describes how the drive can be controlled by external devices over a communication network (fieldbus) using the embedded fieldbus interface.

---

## System overview

The drive can be connected to an external control system through a serial communication link using either a fieldbus adapter or the embedded fieldbus interface.

The embedded fieldbus interface supports the Modbus RTU protocol. The drive control program can receive and send cyclic data from and to the Modbus master on 10 ms time level. The actual communication speed depends on other factors as well, such as the baud rate (a parameter setting in the drive).

The drive can be set to receive all of its control information through the fieldbus interface, or the control can be distributed between the fieldbus interface and other available sources, for example, digital and analogue inputs.

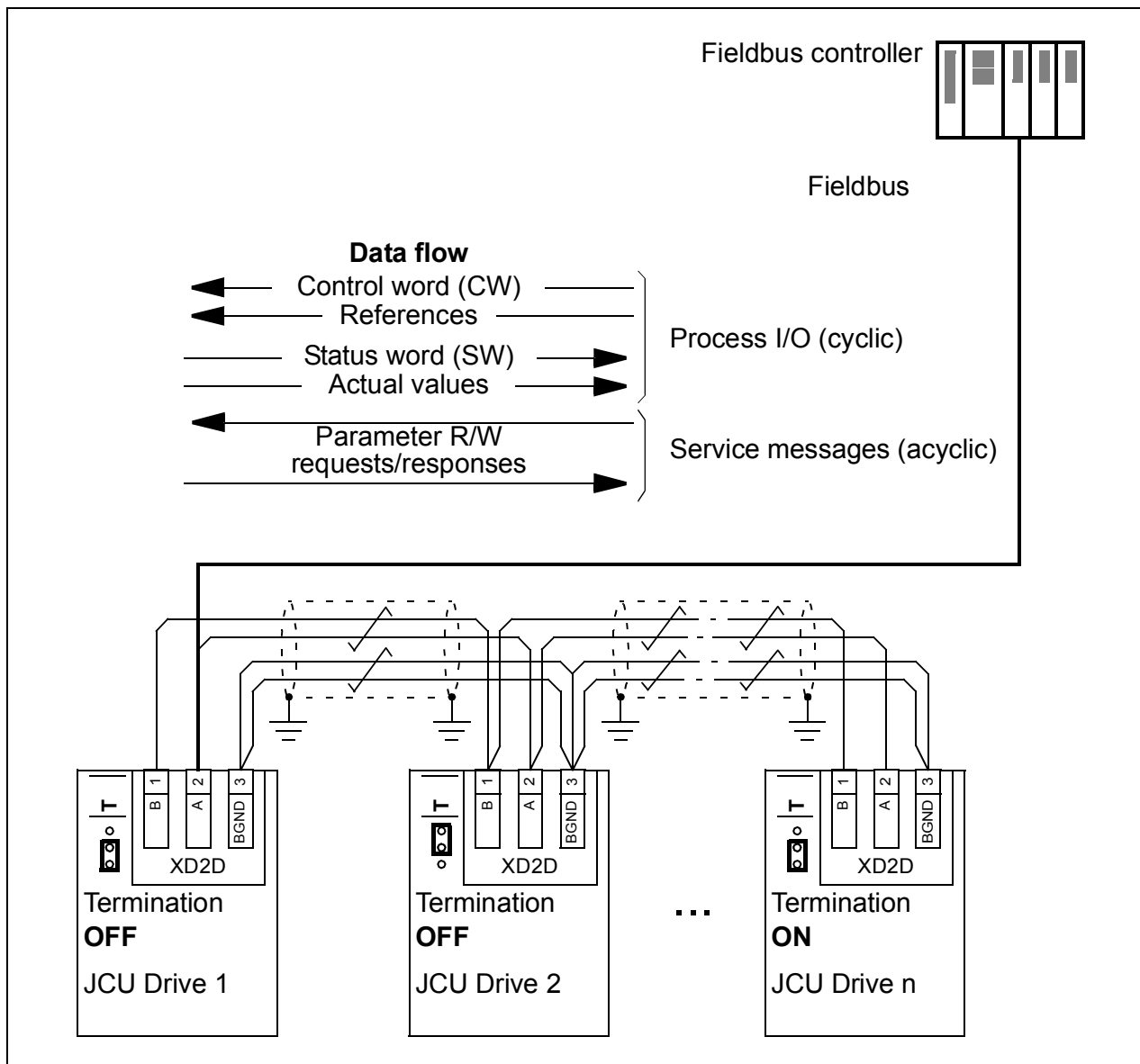

## Connecting the fieldbus to the drive

Connect the fieldbus to terminal XD2D on the JCON board of the drive. See the appropriate *Hardware Manual* for more information on the connection, chaining and termination of the link.

XD2D is the connection point for a drive-to-drive link, a daisy-chained RS-485 transmission line with one master and multiple slaves.

## Setting up the embedded fieldbus interface

Set the drive up for the embedded fieldbus communication with the parameters shown in the table below. The **Setting for fieldbus control** column gives either the value to use or the default value. The **Function/Information column** gives a description of the parameter or instructs in its use.

The new settings will take effect when the drive is powered up the next time, or when parameter [58.10 Refresh settings](#) is activated.

Parameter	Setting for fieldbus control	Function/Information
COMMUNICATION INITIALIZATION		
<a href="#">50.15 FBA cw used</a>	P.02.36	Selects the address of the Fieldbus control word in use ( <a href="#">02.36 EFB main cw</a> ).
<a href="#">58.01 Protocol enable</a>	<i>Modbus RTU</i>	Initializes embedded fieldbus communication.
EMBEDDED MODBUS CONFIGURATION		
<a href="#">58.03 Node address</a>	1 (default)	Node address. There may not be two nodes with the same node address online.
<a href="#">58.04 Baud rate</a>	9600 (default)	Defines the communication speed of the link. Use the same setting as in the master station.
<a href="#">58.05 Parity</a>	<i>8 none 1</i> (default)	Selects the parity and stop bit setting. Use the same setting as in the master station.
<a href="#">58.06 Control profile</a>	<i>ABB Enhanced</i> (default)	Selects the communication profile used by the drive. See section <a href="#">Basics of the embedded fieldbus interface</a> on page 362.
<a href="#">58.07 Comm loss timeout</a>	600 (default)	Defines the timeout limit for the EFB communication monitoring.
<a href="#">58.08 Comm loss mode</a>	<i>None</i> (default)	Enables/disables EFB communication loss monitoring and defines the means for resetting the counter of the communication loss delay.
<a href="#">58.09 Comm loss action</a>	<i>None</i> (default)	Defines the drive operation after the EFB communication loss monitoring awakes.
<a href="#">58.10 Refresh settings</a>	<i>Done</i> (default)	Refreshes the settings of parameters <a href="#">58.01...58.09</a> .
<a href="#">58.30 Transmit delay</a>	0 (default)	Defines the delay time which the slave waits until it sends a response.
<a href="#">58.31 Ret app errors</a>	<i>Yes</i> (default)	Selects whether the drive returns Modbus exception codes or not.
<a href="#">58.32 Word order</a>	<i>LSW MSW</i> (default)	Defines the order of the data words in the Modbus frame.

Parameter	Setting for fieldbus control	Function/Information
58.35 Data I/O 1 ... 58.58 Data I/O 24	0 (default)	Defines the address of the drive parameter which the Modbus master accesses when it reads from or writes to the register address corresponding to Modbus In/Out parameters. Select the parameters that you want to read or write through the Modbus I/O words.

## Setting the drive control parameters

After the embedded fieldbus interface has been set up, check and adjust the drive control parameters listed in the table below. The **Setting for fieldbus control** column gives the value or values to use when the embedded fieldbus signal is the desired source or destination for that particular drive control signal. The **Function/Information** column gives a description of the parameter.

Parameter	Setting for fieldbus control	Function/Information
-----------	------------------------------	----------------------

CONTROL COMMAND SOURCE SELECTION		
<a href="#">10.01 Ext1 start func</a>	<a href="#">FBA</a>	Selects fieldbus as the source for the start and stop commands when EXT1 is selected as the active control location.
<a href="#">10.04 Ext2 start func</a>	<a href="#">FBA</a>	Selects fieldbus as the source for the start and stop commands when EXT2 is selected as the active control location.
<a href="#">10.10 Fault reset sel</a>	P.02.36.08	Selects the fault reset bit of signal <a href="#">02.36 EFB main cw</a> as the source for the fault reset command of the drive.
<b>Note:</b> To start and stop the drive through control location EXT1, set parameter <a href="#">10.01</a> to <a href="#">FBA</a> and keep parameter <a href="#">12.01</a> to its default value (C.FALSE).		

SPEED REFERENCE SELECTION		
<a href="#">21.01 Speed ref1 sel</a>	<a href="#">EFB ref1</a> or <a href="#">EFB ref2</a>	Selects a reference received through the embedded fieldbus interface as the speed reference ref1 of the drive.
<a href="#">21.02 Speed ref2 sel</a>	<a href="#">EFB ref1</a> or <a href="#">EFB ref2</a>	Selects a reference received through the embedded fieldbus interface as the speed reference ref2 of the drive.
<b>Note:</b> To control the drive speed with the Embedded fieldbus reference REF1, set parameter <a href="#">21.01</a> to <a href="#">EFB ref1</a> and keep parameter <a href="#">12.01</a> to its default value (C.FALSE).		

REFERENCE SCALING		
<a href="#">50.04 FBA ref1 modesel</a>	<a href="#">Raw data</a> <a href="#">Speed</a>	Defines the fieldbus reference REF1 scaling. Selects also the fieldbus actual signal act1 when set to <a href="#">Speed</a> .
<a href="#">50.05 FBA ref2 modesel</a>	<a href="#">Raw data</a> <a href="#">Speed</a>	Defines the fieldbus reference REF2 scaling. Selects also the fieldbus actual signal act2 when set to <a href="#">Speed</a> .

ACTUAL VALUE ACT1 AND ACT 2 SELECTION (if <a href="#">50.04</a> or <a href="#">50.05</a> has value <a href="#">Raw data</a> ).		
<a href="#">50.06 FBA act1 tr src</a>	Any	Selects the source for fieldbus actual value act1 when parameter <a href="#">50.04 FBA ref1 modesel</a> is set to <a href="#">Raw data</a> .



Parameter	Setting for fieldbus control	Function/Information
<a href="#">50.07 FBA act2 tr src</a>	Any	Selects the source for fieldbus actual value act2 when parameter <a href="#">50.05 FBA ref2 modesel</a> is set to <i>Raw data</i> .
SYSTEM CONTROL INPUTS		
<a href="#">16.07 Param save</a>	<i>Save</i> (restores to <i>Done</i> )	Saves parameter value changes (including those made through fieldbus control) to permanent memory.

## Basics of the embedded fieldbus interface

The cyclic communication between a fieldbus system and the drive consists of 16-bit data words (with the ABB Drives profile or DCU 16-bit profile) or 32-bit data words (with the DCU 32-bit profile).

The diagram below illustrates the operation of the fieldbus interface. The signals transferred in the cyclic communication are explained further below the diagram.

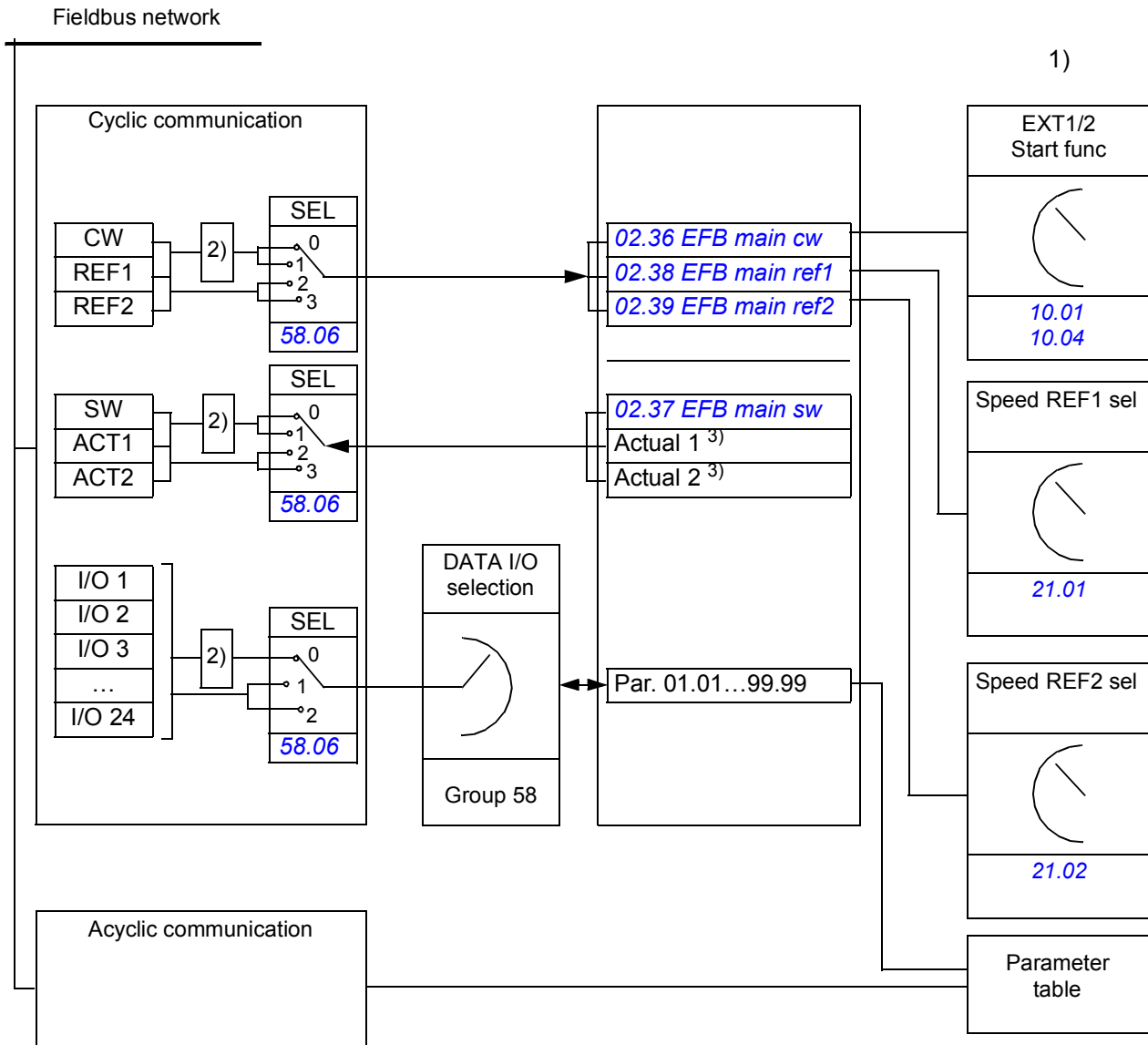

1) See also other parameters which can be controlled by the fieldbus.

2) Data conversion if parameter [58.06 Control profile](#) is (0) *ABB Classic* or (1) *ABB Enhanced*. See section [About the EFB communication profiles](#) on page 364.

3) See parameter [50.04 FBA ref1 modesel](#) and [50.05 FBA ref2 modesel](#) for the actual value selections.

## ■ Control word and Status word

The Fieldbus control word (CW) is a 16-bit or 32-bit packed boolean word. It is the principal means of controlling the drive from a fieldbus system. The Control word is sent by the fieldbus controller to the drive. The drive switches between its states according to the bit-coded instructions of the Control word. In the embedded fieldbus communication, the CW is written to drive parameter [02.36 EFB main cw](#) from where it can be used in the control of the drive. The Fieldbus CW is either written to the drive Control word as it is, or the data is converted. See section [About the EFB communication profiles](#) on page [364](#).

The Fieldbus status word (SW) is a 16-bit or 32-bit packed boolean word. It contains status information from the drive to the fieldbus controller. In the embedded fieldbus communication, the SW is read from drive parameter [02.37 EFB main sw](#). The Drive status word is either written to the fieldbus SW as it is or the data is converted. See section [About the EFB communication profiles](#) on page [364](#).

## ■ References

Fieldbus references (REF1 and REF2) are 16-bit or 32-bit signed integers. The contents of each reference word can be used as the speed or process reference. In the embedded fieldbus communication, the REF1 and REF2 are written to [02.38 EFB main ref1](#) and [02.39 EFB main ref2](#) from where you can use them in the control of the drive. The references are either written to the drive references as they are, or the values are scaled. See section [About the EFB communication profiles](#) on page [364](#).

## ■ Actual values

Fieldbus actual signals (ACT1 and ACT2) are 16-bit or 32-bit signed integers. They convey selected drive parameter values from the drive to the master. The drive values are either written to the fieldbus actual values as they are, or the values are scaled. See section [About the EFB communication profiles](#) on page [364](#).

## ■ Data inputs/outputs

Data input/output (I/O) are 16-bit or 32-bit words containing selected drive parameter values. Parameters [58.35 Data I/O 1](#) ... [58.58 Data I/O 24](#) define the addresses from which the master either reads data (input) or to which it writes data (output).

---

## About the EFB communication profiles

A communication profile defines the rules for data transfer in between the drive and the fieldbus master, for example:

- if packed boolean words are converted and how
- if the signal values are scaled and how
- how the drive register addresses are mapped for the fieldbus master.

You can configure the drive to receive and send messages according to one of the four profiles: the ABB Drives classic profile, ABB Drives enhanced profile, 16-bit DCU profile or 32-bit DCU profile. For either one of the ABB Drives profile, the embedded fieldbus interface of the drive converts the fieldbus data to and from the native data used in the drive. Both DCU profiles are transparent, that is, no data conversion is done. The figure below illustrates the effect of the profile selection.

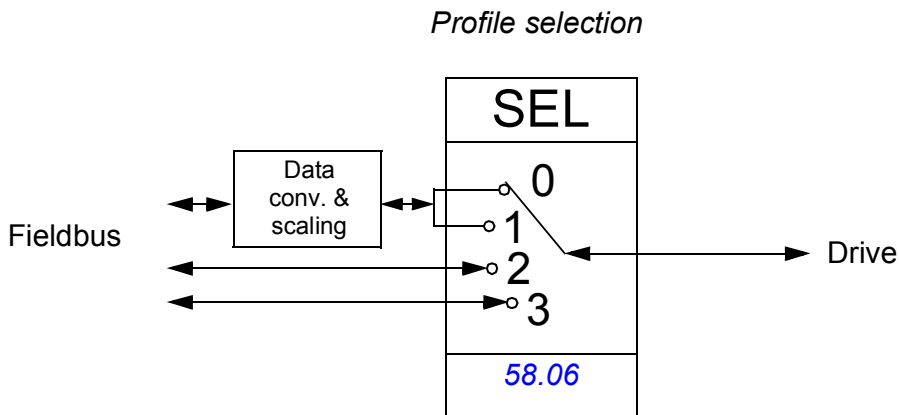

Communication profile selection with parameter *58.06 Control profile* are:

- (0) *ABB Classic*
- (1) *ABB Enhanced*
- (2) *DCU 16-bit*
- (2) *DCU 32-bit*

## ABB Drives classic profile and ABB Drives enhanced profile

### ■ Control word for the ABB Drives profiles

The table below shows the contents of the Fieldbus control word for both ABB Drives profiles. The embedded fieldbus interface converts this word to the form in which it is used in the drive (*02.36 EFB main cw*). The upper case boldface text refers to the states shown in *State transition diagram for the ABB Drives profiles* on page 369.

Bit	Name	Value	STATE/Description
0	OFF1_ CONTROL	1	Proceed to <b>READY TO OPERATE</b> .
		0	Stop along currently active deceleration ramp. Proceed to <b>OFF1 ACTIVE</b> ; proceed to <b>READY TO SWITCH ON</b> unless other interlocks (OFF2, OFF3) are active.
1	OFF2_ CONTROL	1	Continue operation (OFF2 inactive).
		0	Emergency OFF, coast to stop. Proceed to <b>OFF2 ACTIVE</b> , proceed to <b>SWITCH-ON INHIBITED</b> .
2	OFF3_ CONTROL	1	Continue operation (OFF3 inactive).
		0	Emergency stop, stop within time defined by drive parameter. Proceed to <b>OFF3 ACTIVE</b> ; proceed to <b>SWITCH-ON INHIBITED</b> . <b>Warning:</b> Ensure motor and driven machine can be stopped using this stop mode.
3	INHIBIT_ OPERATION	1	Proceed to <b>OPERATION ENABLED</b> . <b>Note:</b> Run enable signal must be active; see the drive documentation. If the drive is set to receive the Run enable signal from the fieldbus, this bit activates the signal.
		0	Inhibit operation. Proceed to <b>OPERATION INHIBITED</b> .
4	RAMP_OUT_ ZERO	1	Normal operation. Proceed to <b>RAMP FUNCTION GENERATOR: OUTPUT ENABLED</b> .
		0	Force Ramp Function Generator output to zero. Drive ramps to stop (current and DC voltage limits in force).
5	RAMP_HOLD	1	Enable ramp function. Proceed to <b>RAMP FUNCTION GENERATOR: ACCELERATOR ENABLED</b> .
		0	Halt ramping (Ramp Function Generator output held).
6	RAMP_IN_ ZERO	1	Normal operation. Proceed to <b>OPERATING</b> . <b>Note:</b> This bit is effective only if the fieldbus interface is set as the source for this signal by drive parameters.
		0	Force Ramp Function Generator input to zero.

Bit	Name	Value	STATE/Description
7	RESET	0=>1	Fault reset if an active fault exists. Proceed to <b>SWITCH-ON INHIBITED</b> . <b>Note:</b> This bit is effective only if the fieldbus interface is set as the source for this signal by drive parameters.
		0	Continue normal operation.
8, 9	Reserved.		
10	REMOTE_CMD	1	Fieldbus control enabled.
		0	Control word <> 0 or Reference <> 0: Retain last Control word and Reference. Control word = 0 and Reference = 0: Fieldbus control enabled. Reference and deceleration/acceleration ramp are locked.
11	EXT_CTRL_LOC	1	Select External Control Location EXT2. Effective if control location is parameterized to be selected from fieldbus.
		0	Select External Control Location EXT1. Effective if control location is parameterized to be selected from fieldbus.
12 ...15	Reserved		

## ■ Status word for the ABB Drives profiles

The table below shows the Fieldbus status word for both ABB Drives profiles. The embedded fieldbus interface converts the Drive status word ([02.37 EFB main sw](#)) to this form for the transfer in the fieldbus. The upper case boldface text refers to the states shown in [State transition diagram for the ABB Drives profiles](#) on page 369.

Bit	Name	Value	STATE/Description
0	RDY_ON	1	<b>READY TO SWITCH ON.</b>
		0	<b>NOT READY TO SWITCH ON.</b>
1	RDY_RUN	1	<b>READY TO OPERATE.</b>
		0	<b>OFF1 ACTIVE.</b>
2	RDY_REF	1	<b>OPERATION ENABLED.</b>
		0	<b>OPERATION INHIBITED.</b>
3	TRIPPED	1	<b>FAULT.</b>
		0	No fault.
4	OFF_2_STA	1	OFF2 inactive.
		0	<b>OFF2 ACTIVE.</b>
5	OFF_3_STA	1	OFF3 inactive.
		0	<b>OFF3 ACTIVE.</b>
6	SWC_ON_ INHIB	1	<b>SWITCH-ON INHIBITED.</b>
		0	–
7	ALARM	1	Warning/Alarm.
		0	No warning/alarm.
8	AT_ SETPOINT	1	<b>OPERATING.</b> Actual value equals Reference = is within tolerance limits, i.e. in speed control, speed error is 10% max. of nominal motor speed.
		0	Actual value differs from Reference = is outside tolerance limits.
9	REMOTE	1	Drive control location: REMOTE (EXT1 or EXT2).
		0	Drive control location: LOCAL.
10	ABOVE_ LIMIT	1	Actual frequency or speed equals or exceeds supervision limit (set by drive parameter). Valid in both directions of rotation.
		0	Actual frequency or speed within supervision limit.
11	EXT_CTRL_ LOC	1	External Control Location EXT2 selected.
		0	External Control Location EXT1 selected.
12	EXT_RUN_ ENABLE	1	External Run Enable signal received.
		0	No External Run Enable signal received.
13 ... 14	Reserved		

368 *Control through the embedded fieldbus interface*

<b>Bit</b>	<b>Name</b>	<b>Value</b>	<b>STATE/Description</b>
15		1	Communication error detected by fieldbus adapter module.
		0	Fieldbus adapter communication OK.



## ■ State transition diagram for the ABB Drives profiles

The diagram below shows the state transitions in the drive when the drive has either one of the ABB Drives profiles in use and the drive is configured to follow the commands of the embedded Fieldbus control word. The upper case texts refer to the states which are used in the tables representing the Fieldbus control and status words. See sections [Control word for the ABB Drives profiles](#) on page 365 and [Status word for the ABB Drives profiles](#) on page 367.

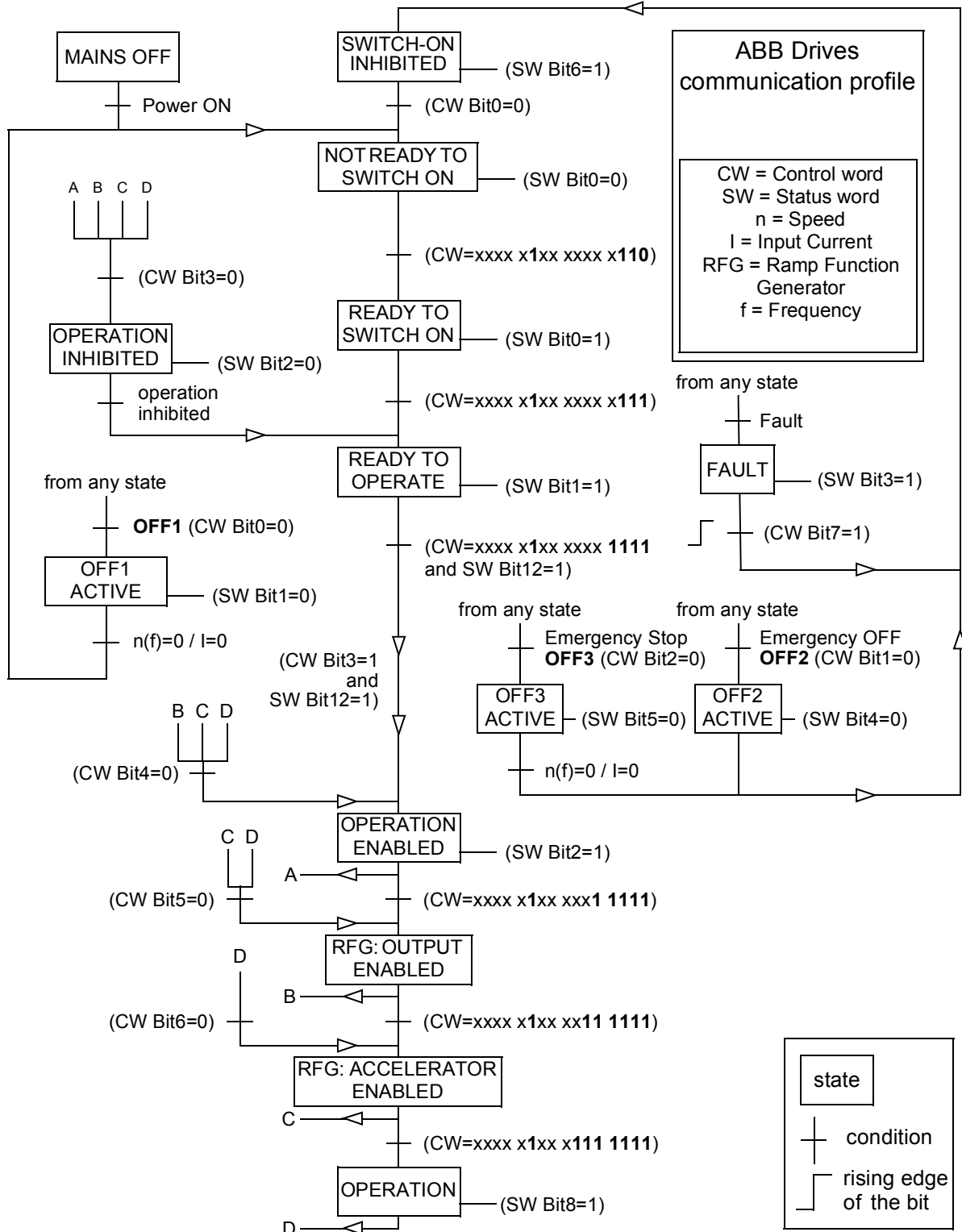

## ■ References for the ABB Drives profiles

The ABB Drives profiles support the use of two Fieldbus references, REF1 and REF2. The references are 16-bit words each containing a sign bit and a 15-bit integer. A negative reference is formed by calculating the two's complement from the corresponding positive reference.

The fieldbus references are scaled before they are written into signals [02.38 EFB main ref1](#) or [02.39 EFB main ref2](#) for the use in the drive. Parameters [50.04 FBA ref1 modesel](#) and [50.05 FBA ref2 modesel](#) define the scaling and possible use of the fieldbus reference REF1 and REF2 as follows:

- If you select value *Speed*, the fieldbus reference can be used as a speed reference and it is scaled as follows:

Fieldbus reference REF1 or REF2 [integer]	Corresponding speed reference in the drive [rpm]
20 000	value of parameter <a href="#">19.01 Speed scaling</a>
0	0
-20 000	-(value of parameter <a href="#">19.01 Speed scaling</a> )

- If you select value *Raw data*, the fieldbus reference is scaled as shown in the table below.

Fieldbus reference REF1 or REF2 [integer]	Corresponding reference in the drive [rpm]
32 767	$k \times 0.5$ (k = value of parameter <a href="#">58.11</a> )
0	0
-32 768	$k \times -0.5$ (k = value of parameter <a href="#">58.11</a> )

## ■ Actual values for the ABB Drives profiles

Both the ABB Drives classic profile and ABB Drives enhanced profile support the use of two fieldbus actual values, ACT1 and ACT2. The actual values are 16-bit words each containing a sign bit and a 15-bit integer. A negative value is formed by calculating the two's complement from the corresponding positive value.

The drive signals are scaled before written into fieldbus actual values, ACT1 and ACT2. Parameters [50.04 FBA ref1 modesel](#) and [50.05 FBA ref2 modesel](#) both select the drive actual signals and define the scaling as follows:

- If you select value [Speed](#), the drive actual signal [01.01 Motor speed rpm](#) is scaled and written to the fieldbus actual value. The scaling is as follows:

Value of <a href="#">01.01 Motor speed rpm</a> [rpm]	Corresponding fieldbus actual value ACT1 or ACT2 [integer]
value of parameter <a href="#">19.01 Speed scaling</a>	20 000
0	0
-(value of parameter <a href="#">19.01 Speed scaling</a> )	-20 000

- If you select value [Raw data](#), the drive parameters [50.06 FBA act1 tr src](#) and [50.07 FBA act2 tr src](#) select the drive values for fieldbus actual value ACT1 and ACT2. The table below shows the scaling.

Drive value	Corresponding fieldbus actual value ACT1 or ACT2 [integer]
$k \times 0.5$ (k = value of parameter <a href="#">58.11</a> )	32 767
0	0
$k \times -0.5$ (k = value of parameter <a href="#">58.11</a> )	-32 768

## ■ Modbus register addresses for the ABB Drives classic profile

The table below shows the Modbus register addresses for the drive data with the ABB Drives classic profile. This profile provides a converted 16-bit access to the drive data.

**Note:** Only the least significant 16-bits of drive 32-bit control and status words can be accessed.

Register Address	Register Data (16-bit)
400001	Fieldbus control word (CW). See section <a href="#">Control word for the ABB Drives profiles</a> on page 365.
400002	Fieldbus reference 1 (REF1)
400003	Fieldbus reference 2 (REF2)
400004	Fieldbus status word (SW). See section <a href="#">Status word for the ABB Drives profiles</a> on page 367.
400005	Fieldbus actual value 1 (ACT1)
400006	Fieldbus actual value 2 (ACT2)
400007	Fieldbus data in/out 1 (Drive parameter <a href="#">58.35 Data I/O 1</a> )
...	...
400030	Fieldbus data in/out 24 (Drive Parameter <a href="#">58.58 Data I/O 24</a> )
400101...409999	<p>Register address (16-bit drive parameter) = 400000 + 100 × group + index</p> <p>Example: Modbus register address to drive parameter 03.18 is  <math>400000 + 100 \times 3 + 18 = 400318</math></p> <p>Drive parameter access (32-bit drive parameter) = 420000 + 200 × group + 2 × index</p> <p>Example: Modbus register address to drive parameter 01.27  <math>420000 + 200 \times 1 + 2 \times 27 = 420254</math></p>

## ■ Modbus register addresses for the ABB Drives enhanced profile

Register address	Register data (16-bit words)
400001	Fieldbus control word (CW). See section <a href="#">Control word for the ABB Drives profiles</a> on page 365.
400002	Fieldbus reference 1 (REF1).
400003	Fieldbus reference 2 (REF2).
400004	Fieldbus data in/out 1 (Drive parameter <a href="#">58.35 Data I/O 1</a> )
...	...
400015	Fieldbus data in/out 12 (Drive parameter <a href="#">58.46 Data I/O 12</a> )
400051	Fieldbus status word (SW). See section <a href="#">Status word for the ABB Drives profiles</a> on page 367.
400052	Fieldbus actual value 1 (ACT1)
400053	Fieldbus actual value 2 (ACT2)
400054	Fieldbus data in/out 13 (Drive parameter <a href="#">58.47 Data I/O 13</a> )
...	...
400065	Fieldbus data in/out 24 (Drive parameter <a href="#">58.58 Data I/O 24</a> )
400101...409999	<p>Register address (16-bit drive parameter) = 400000 + 100 × group + index</p> <p>Example: Modbus register address to drive parameter 03.18 is  <math>400000 + 100 \times 3 + 18 = 400318</math></p> <p>Drive parameter access (32-bit drive parameter) = 420000 + 200 × group + 2 × index</p> <p>Example: Modbus register address to drive parameter 01.27  <math>420000 + 200 \times 1 + 2 \times 27 = 420254</math></p>

## **DCU 16-bit profile**

### **■ Control and Status words for the DCU 16-bit profile**

When the DCU 16-bit profile is in use, the embedded fieldbus interface writes the Fieldbus control word as is to the Drive control word bits 0 to 15 (parameter [02.36 EFB main cw](#)). Bits 16 to 32 of the Drive control word are not in use.

### **■ Status word for the DCU 16-bit profile**

When the DCU 16-bit profile is in use, the embedded fieldbus interface writes the Drive status word bits 0 to 15 (parameter [02.37 EFB main sw](#)) to the Fieldbus status (SW) word as is. Bits 16 to 32 of the Drive status word are not in use.

### **■ State transition diagram for the DCU 16-bit profile**

See section [State diagram](#) on page [391](#) in chapter [Control through a fieldbus adapter](#).

### **■ References for the DCU 16-bit profile**

See section [References for the ABB Drives profiles](#) on page [370](#).

### **■ Actual signals for the DCU 16-bit profile**

See section [Actual values for the ABB Drives profiles](#) on page [371](#).

---

## ■ Modbus register addresses for the DCU 16-bit profile

The table below shows the Modbus register addresses and data with the DCU16-bit communication profile.

**Note:** Only the least significant 16-bits of the drive 32-bit control and status words can be accessed.

Register address	Register data (16-bit)
400001	Control word (LSW of <a href="#">02.36 EFB main cw</a> )
400002	Reference 1 ( <a href="#">02.38 EFB main ref1</a> )
400003	Reference 2 ( <a href="#">02.39 EFB main ref2</a> )
400004	Data in/out 1 (Drive parameter <a href="#">58.35 Data I/O 1</a> )
...	...
400015	Data in/out 12 (Drive parameter <a href="#">58.46 Data I/O 12</a> )
400051	Status word (LSW of <a href="#">02.37 EFB main sw</a> )
400052	Actual value 1 (selected by parameter <a href="#">50.04 FBA ref1 modesel</a> )
400053	Actual value 2 (selected by parameter <a href="#">50.05 FBA ref2 modesel</a> )
400054	Data in/out 13 (drive parameter <a href="#">58.47 Data I/O 13</a> )
...	...
400065	Data in/out 24 (drive parameter <a href="#">58.58 Data I/O 24</a> )
400101...409999	<p>Register address (16-bit drive parameter) = 400000 + 100 × group + index</p> <p>Example: Modbus register address to drive parameter 03.18 is  <math>400000 + 100 \times 3 + 18 = 400318</math></p> <p>Drive parameter access (32-bit drive parameter) = 420000 + 200 × group + 2 × index</p> <p>Example: Modbus register address to drive parameter 01.27  <math>420000 + 200 \times 1 + 2 \times 27 = 420254</math></p>

## **DCU 32-bit profile**

### **■ Control and Status words for the DCU 32-bit profile**

When the DCU 32-bit profile is in use, the embedded fieldbus interface writes the Fieldbus control word as is to the Drive control word (parameter [02.36 EFB main cw](#)).

### **■ Status word for the DCU 32-bit profile**

When the DCU 32-bit profile is in use, the embedded fieldbus interface writes the Drive status word (parameter [02.37 EFB main sw](#)) as is to the Fieldbus status word (SW).

### **■ State transition diagram for the DCU 32-bit profile**

See section [State diagram](#) on page [391](#) in chapter [Control through a fieldbus adapter](#).



## ■ References for the DCU 32-bit profile

The DCU 32-bit profile supports the use of two fieldbus references, REF1 and REF2. The references are 32-bit values consisting of two 16-bit words. The MSW (Most significant word) is the integer part and the LSW (Least significant word) the fractional part of the value. A negative reference is formed by calculating the two's complement from the corresponding positive value of the integer part (MSW).

The fieldbus references are written as is into the drive reference values ([02.38 EFB main ref1](#) or [02.39 EFB main ref2](#)). Parameters [50.04 FBA ref1 modesel](#) and [50.05 FBA ref2 modesel](#) define the reference types (speed or torque) as follows:

- If you select value [Raw data](#), the fieldbus reference type or possible use is not selected. The value is freely usable as a speed or torque reference in the drive. The table below clarifies the relation between the fieldbus reference and drive reference (no scaling).

Fieldbus reference REF1 or REF2 [integer and fractional part]	Corresponding reference in the drive [rpm or %] <sup>1)</sup>
32767.65535	32767.65535
0	0
-32768.65535	-32768.65535

<sup>1)</sup> If the reference value is used as the speed reference, it will be the motor speed in rpm. If the reference value is used as the torque reference, it will be the motor torque in percent of the motor nominal torque.

- If you select value [Speed](#), the fieldbus reference can be used as a speed reference in the drive. The table below clarifies the relation between the fieldbus reference and drive reference (no scaling).

Fieldbus reference REF1 or REF2 [integer and fractional part]	Corresponding speed reference in the drive [rpm]
32767.65535	32767.65535
0	0
-32768.65535	-32768.65535

## Actual signals for the DCU 32-bit profile

The DCU 32-bit profile supports the use of two fieldbus actual values ACT1 and ACT2. The fieldbus actual values are 32-bit values consisting of two 16-bit words. The MSW (Most significant word) is the integer part and the LSW (Least significant word) the fractional part of the 32-bit value. A negative reference is formed by calculating the two's complement from the corresponding positive value of the integer part (MSW).

Parameters [50.04 FBA ref1 modesel](#) and [50.05 FBA ref2 modesel](#) select the drive actual signals for the fieldbus actual values ACT1 and ACT2 respectively as follows:

- If you select value [Raw data](#), the drive parameters [50.06 FBA act1 tr src](#) and [50.07 FBA act2 tr src](#) select the drive parameters for the fieldbus actual value

ACT1 and ACT2 respectively. The table below clarifies the relation between the value of drive parameter and fieldbus actual value (no scaling).

Value of the selected drive signal	Corresponding fieldbus actual value ACT1 or ACT2 [integer and fractional part]
32767.65535	32767.65535
0	0
-32768.65535	-32768.65535

- If you select value *Speed*, the drive parameter *01.01 Motor speed rpm* will be written to fieldbus actual value. The table below clarifies the relation between the value of drive parameter value and the fieldbus actual value (no scaling).

Value of the selected drive signal	Corresponding fieldbus actual value ACT1 or ACT2 [integer and fractional part]
32767.65535	32767.65535
0	0
-32768.65535	-32768.65535

## ■ Modbus register addresses for the DCU 32-bit profile

The table below shows the Modbus register addresses and data with the DCU 32-bit profile. This profile provides native 32-bit access to the drive data.

Register address	Register data (16-bit)
400001	Control word ( <a href="#">02.36 EFB main cw</a> ) – Least significant 16-bits
400002	Control word ( <a href="#">02.36 EFB main cw</a> ) – Most significant 16-bits
400003	Reference 1 ( <a href="#">02.38 EFB main ref1</a> ) – Least significant 16-bits
400004	Reference 1 ( <a href="#">02.38 EFB main ref1</a> ) – Most significant 16-bits
400005	Reference 2 ( <a href="#">02.39 EFB main ref2</a> ) – Least significant 16-bits
400006	Reference 2 ( <a href="#">02.39 EFB main ref2</a> ) – Most significant 16-bits
400007	Data in/out 1 (Drive parameter <a href="#">58.35 Data I/O 1</a> )
...	...
400018	Data in/out 12 (Drive parameter <a href="#">58.46 Data I/O 12</a> )
400051	Status word (LSW of <a href="#">02.37 EFB main sw</a> ) – Least significant 16-bits
400052	Status word (MSW of <a href="#">02.37 EFB main sw</a> ) – Most significant 16-bits
400053	Actual value 1 (selected by parameter <a href="#">50.04 FBA ref1 modesel</a> ) – Least significant 16-bits
400054	Actual value 1 (selected by parameter <a href="#">50.04 FBA ref1 modesel</a> ) – Most significant 16-bits
400055	Actual value 2 (selected by parameter <a href="#">50.05 FBA ref2 modesel</a> ) – Least significant 16-bits
400056	Actual value 2 (selected by parameter <a href="#">50.05 FBA ref2 modesel</a> ) – Most significant 16-bits
400057	Data in/out 13 (Drive parameter <a href="#">58.47 Data I/O 13</a> )
...	...
400068	Data in/out 24 (Drive parameter <a href="#">58.58 Data I/O 24</a> )
400101...409999	<p>Register address (16-bit drive parameter) = 400000 + 100 × group + index</p> <p>Example: Modbus register address to drive parameter 03.18 is  <math>400000 + 100 \times 3 + 18 = 400318</math></p> <p>Drive parameter access (32-bit drive parameter) = 420000 + 200 × group + 2 × index</p> <p>Example: Modbus register address to drive parameter 01.27  <math>420000 + 200 \times 1 + 2 \times 27 = 420254</math></p>

## Modbus function codes

Table below shows the Modbus function codes supported by the embedded fieldbus interface.

Code	Function name	Description
0x03	Read Holding Registers	Reads the contents of a contiguous block of holding registers in a server device.
0x06	Write Single Register	Writes a single holding register in a server device.
0x08	Diagnostics	<p>Provides a series of tests for checking the communication between the master and the slave devices, or for checking various internal error conditions within the slave. The following subcodes are supported:</p> <p>00 Return Query Data: The data passed in the request data field is to be returned in the response. The entire response message should be identical to the request.</p> <p>01 Restart Communications Option: The serial line port of the slave device must be initialized and restarted, and all of its communication event counters cleared. If the port is in the Listen Only mode, no response is returned. If the port is not in the Listen Only mode, a normal response is returned before the restart.</p> <p>04 Force Listen Only Mode: Forces the addressed slave device to the Listen Only mode. This isolates it from the other devices on the network, allowing them to continue communicating without interruption from the addressed remote device. No response is returned. The only function that will be processed after this mode is entered is the Restart Communications Option function (subcode 01).</p>
0x10	Write Multiple Registers	Writes the contents of a contiguous block of holding registers in a server device.
0x17	Read/Write Multiple Registers	Writes the contents of a contiguous block of holding registers in a server device, then reads the contents of a contiguous block of holding registers (same or different than those written) in a server device.
0x2B/0x0E	Encapsulated Interface Transport / Read Device Identification	<p>Allows reading of identification and other information of the server.</p> <p>Parameter "Read Device ID code" supports one access type:</p> <p>01: Request to get the basic device identification. Returns ABB,ACQ810.</p>

## Modbus exception codes

Table below shows the Modbus exception codes supported by the embedded fieldbus interface.

Code	Name	Description
0x01	ILLEGAL FUNCTION	The function code received in the query is not an allowable action for the server.
0x02	ILLEGAL DATA ADDRESS	The data address received in the query is not an allowable address for the server.
0x03	ILLEGAL DATA VALUE	A value contained in the query is not an allowable value for the server.
0x04	SLAVE DEVICE FAILURE	An unrecoverable error occurred while the server was attempting to perform the requested action.
0x06	SLAVE DEVICE BUSY	The server is engaged in processing a long-duration program command.





# Control through a fieldbus adapter

---

## What this chapter contains

The chapter describes how the drive can be controlled by external devices over a communication network (fieldbus).

---

## System overview

The drive can be connected to a fieldbus controller via a fieldbus adapter module. The adapter module is installed into drive Slot 2.

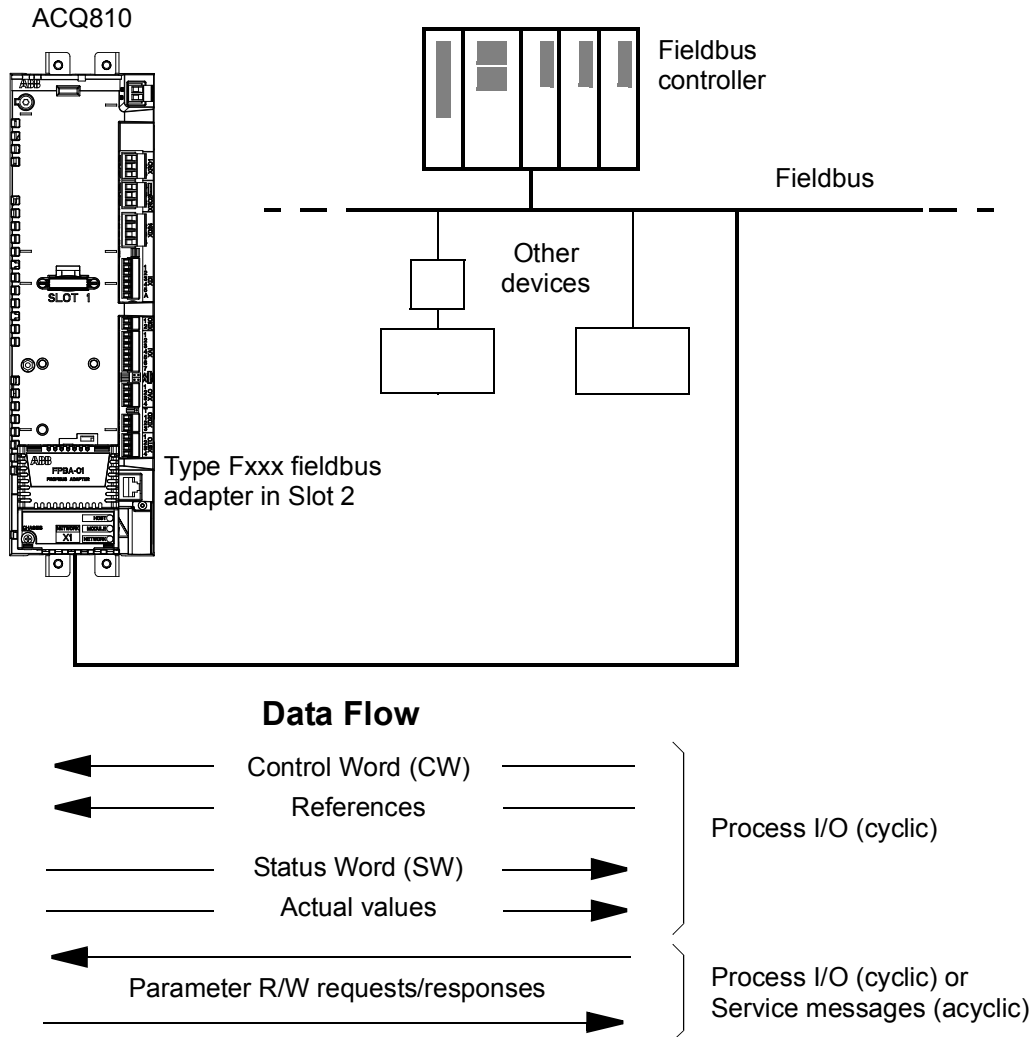

The drive can be set to receive all of its control information through the fieldbus interface, or the control can be distributed between the fieldbus interface and other available sources, for example digital and analog inputs.

Fieldbus adapters are available for various serial communication protocols, for example

- DeviceNet (FDNA-xx adapter)
- EtherNet/IP (FENA-xx adapter)
- LONWORKS<sup>®</sup> (FLON-xx adapter)
- Modbus (FSCA-xx adapter)
- PROFIBUS DP (FPBA-xx adapter)



## Setting up communication through a fieldbus adapter module

Before configuring the drive for fieldbus control, the adapter module must be mechanically and electrically installed according to the instructions given in the User's Manual of the appropriate fieldbus adapter module.

The communication between the drive and the fieldbus adapter module is activated by setting parameter [50.01 FBA enable](#) to *Enable*. The adapter-specific parameters must also be set. See the table below.

Parameter	Setting for fieldbus control	Function/Information
COMMUNICATION INITIALIZATION AND SUPERVISION (see also page <a href="#">242</a> )		
<a href="#">50.01 FBA enable</a>	(1) <i>Enable</i>	Initializes communication between drive and fieldbus adapter module.
<a href="#">50.02 Comm loss func</a>	(0) <i>No</i> (1) <i>Fault</i> (2) <i>Spd ref Safe</i> (3) <i>Last speed</i>	Selects how the drive reacts upon a fieldbus communication break. See also parameter <a href="#">50.21 Comm loss enable</a> .
<a href="#">50.03 Comm loss t out</a>	0.3...6553.5 s	Defines the time between communication break detection and the action selected with parameter <a href="#">50.02 Comm loss func</a> .
<a href="#">50.04 FBA ref1 modesel</a> and <a href="#">50.05 FBA ref2 modesel</a>	(0) <i>Raw data</i> (2) <i>Speed</i>	Defines the fieldbus reference scaling. When <i>Raw data</i> is selected, see also parameters <a href="#">50.06...50.11</a> .
<a href="#">50.21 Comm loss enable</a>	See <a href="#">50.21 Comm loss enable</a> .	Activates fieldbus communication monitoring for control location EXT1 or EXT2, or both. The drive can detect a fieldbus communication break ONLY when it is in a control location where the monitoring is enabled.
ADAPTER MODULE CONFIGURATION (see also page <a href="#">245</a> )		
<a href="#">51.01 FBA type</a>	–	Displays the type of the fieldbus adapter module.
<a href="#">51.02 FBA par2</a> ••• <a href="#">51.26 FBA par26</a>	These parameters are adapter module-specific. For more information, see the <i>User's Manual</i> of the fieldbus adapter module. Note that not all of these parameters are necessarily used.	
<a href="#">51.27 FBA par refresh</a>	(0) <i>Done</i> (1) <i>Refresh</i>	Validates any changed adapter module configuration parameter settings.

Parameter	Setting for fieldbus control	Function/Information
<a href="#">51.28 Par table ver</a>	–	Displays the parameter table revision of the fieldbus adapter module mapping file stored in the memory of the drive.
<a href="#">51.29 Drive type code</a>	–	Displays the drive type code of the fieldbus adapter module mapping file stored in the memory of the drive.
<a href="#">51.30 Mapping file ver</a>	–	Displays the fieldbus adapter module mapping file revision stored in the memory of the drive.
<a href="#">51.31 D2FBA comm sta</a>	–	Displays the status of the fieldbus adapter module communication.
<a href="#">51.32 FBA comm sw ver</a>	–	Displays the common program revision of the adapter module.
<a href="#">51.33 FBA appl sw ver</a>	–	Displays the application program revision of the adapter module.
<b>Note:</b> In the <i>User's Manual</i> of the fieldbus adapter module, the parameter group number is 1 or A for parameters <a href="#">51.01</a> ... <a href="#">51.26</a> .		
TRANSMITTED DATA SELECTION (see also page <a href="#">246</a> )		
<a href="#">52.01 FBA data in1</a> ... <a href="#">52.12 FBA data in12</a>	4...6 14...16 101...9999	Defines the data transmitted from drive to fieldbus controller. <b>Note:</b> If the selected data is 32 bits long, two parameters are reserved for the transmission.
<a href="#">53.01 FBA data out1</a> ... <a href="#">53.12 FBA data out12</a>	1...3 11...13 1001...9999	Defines the data transmitted from fieldbus controller to drive. <b>Note:</b> If the selected data is 32 bits long, two parameters are reserved for the transmission.
<b>Note:</b> In the <i>User's Manual</i> of the fieldbus adapter module, the parameter group number is 2 or B for parameters <a href="#">52.01</a> ... <a href="#">52.12</a> and 3 or C for parameters <a href="#">53.01</a> ... <a href="#">53.12</a> .		

After the module configuration parameters have been set, the drive control parameters (see section [Drive control parameters](#) below) must be checked and adjusted when necessary.

The new settings will take effect when the drive is powered up the next time (before powering off the drive, wait at least 1 minute), or when parameter [51.27 FBA par refresh](#) is activated.

## Drive control parameters

The Setting for fieldbus control column gives the value to use when the fieldbus interface is the desired source or destination for that particular signal. The Function/Information column gives a description of the parameter.

Parameter	Setting for fieldbus control	Function/Information
CONTROL COMMAND SOURCE SELECTION		
<i>10.01 Ext1 start func</i>	(3) <i>FBA</i>	Selects fieldbus as the source for the start and stop commands when EXT1 is selected as the active control location.
<i>10.04 Ext2 start func</i>	(3) <i>FBA</i>	Selects fieldbus as the source for the start and stop commands when EXT2 is selected as the active control location.
<i>21.01 Speed ref1 sel</i>	(3) <i>FBA ref1</i> (4) <i>FBA ref2</i>	Fieldbus reference REF1 or REF2 is used as speed reference.
SYSTEM CONTROL INPUTS		
<i>16.07 Param save</i>	(0) <i>Done</i> (1) <i>Save</i>	Saves parameter value changes (including those made through fieldbus control) to permanent memory.

## The fieldbus control interface

The cyclic communication between a fieldbus system and the drive consists of 16/32-bit input and output data words. The drive supports at the maximum the use of 12 data words (16 bits) in each direction.

Data transmitted from the drive to the fieldbus controller is defined by parameters [52.01 FBA data in1](#) ... [52.12 FBA data in12](#). The data transmitted from the fieldbus controller to the drive is defined by parameters [53.01 FBA data out1](#) ... [53.12 FBA data out12](#).

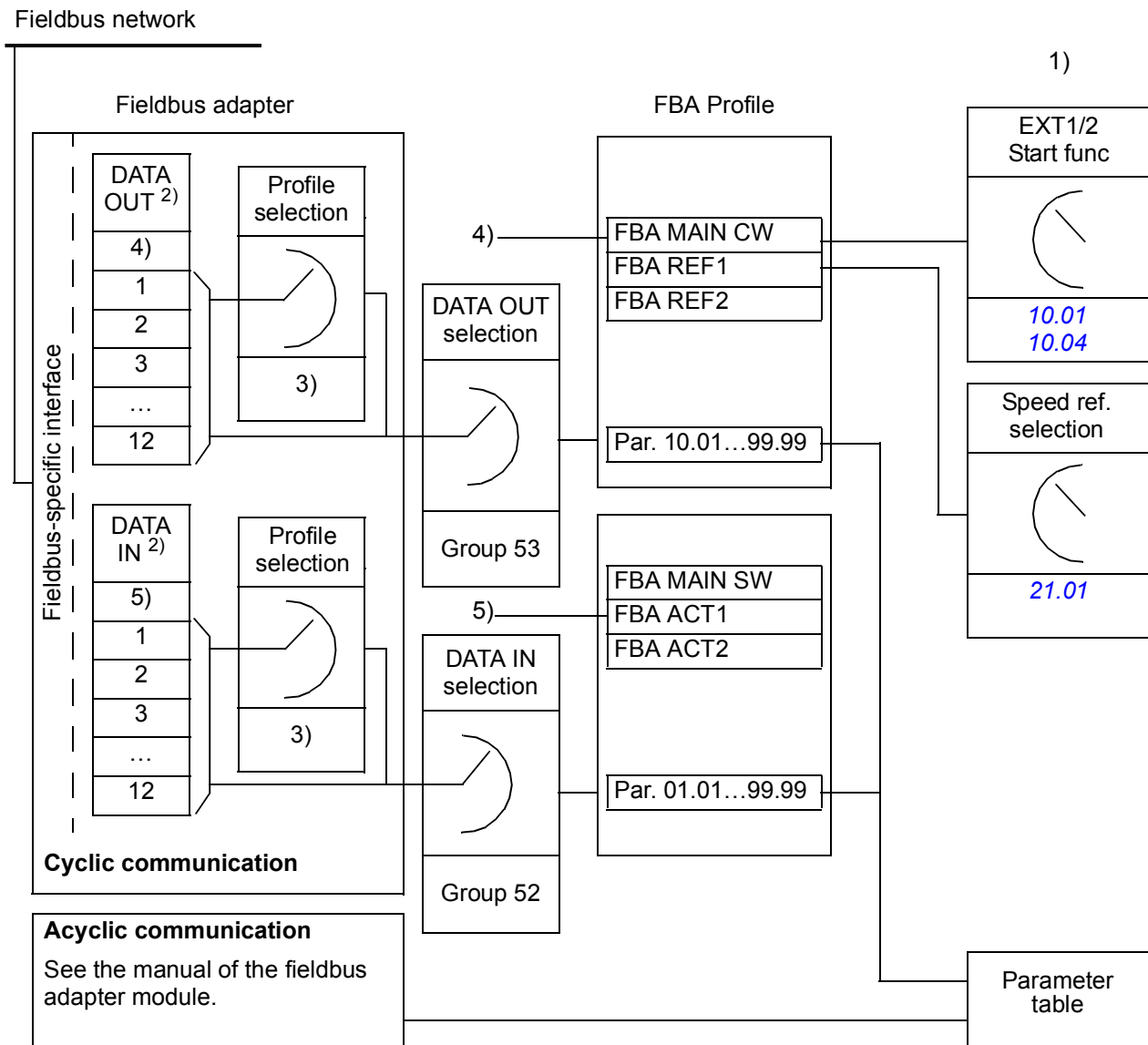

- 1) See also other parameters which can be controlled by the fieldbus.
- 2) The maximum number of used data words is protocol-dependent.
- 3) Profile/instance selection parameters. Fieldbus module specific parameters. For more information, see the *User's Manual* of the appropriate fieldbus adapter module.
- 4) With DeviceNet, the control part is transmitted directly.
- 5) With DeviceNet, the actual value part is transmitted directly.

## ■ The Control Word and the Status Word

The Control Word (CW) is the principal means of controlling the drive from a fieldbus system. The Control Word is sent by the fieldbus controller to the drive. The drive switches between its states according to the bit-coded instructions of the Control Word.

The Status Word (SW) is a word containing status information, sent by the drive to the fieldbus controller.

## ■ Actual values

Actual values (ACT) are 16/32-bit words containing information on selected operations of the drive.

## FBA communication profile

The FBA communication profile is a state machine model which describes the general states and state transitions of the drive. The *State diagram* on page 391 presents the most important states (including the FBA profile state names). The FBA Control Word (parameter 02.22 – see page 121) commands the transitions between these states and the FBA Status Word (parameter 02.24 – see page 123) indicates the status of the drive.

Fieldbus adapter module profile (selected by adapter module parameter) defines how the control word and status word are transmitted in a system which consists of fieldbus controller, fieldbus adapter module and drive. With transparent modes, control word and status word are transmitted without any conversion between the fieldbus controller and the drive. With other profiles (e.g. PROFIdrive for FPBA-01, AC/DC drive for FDNA-01, and ABB Drives profile for all fieldbus adapter modules) fieldbus adapter module converts the fieldbus-specific control word to the FBA communication profile and status word from FBA communication profile to the fieldbus-specific status word.

For descriptions of other profiles, see the User's Manual of the appropriate fieldbus adapter module.

---

## ■ Fieldbus references

References (FBA REF) are 16/32-bit signed integers. A negative reference (indicating reversed direction of rotation) is formed by calculating the two's complement from the corresponding positive reference value. The contents of each reference word can be used as torque or speed reference.

When torque or speed reference scaling is selected (by parameter [50.04 FBA ref1 modesel](#) / [50.05 FBA ref2 modesel](#)), the fieldbus references are 32-bit integers. The value consists of a 16-bit integer value and a 16-bit fractional value. The speed/torque reference scaling is as follows:

Reference	Scaling	Notes
Speed reference	FBA REF / 65536 (value in rpm)	Final reference is limited by parameters <a href="#">20.01 Maximum speed</a> , <a href="#">20.02 Minimum speed</a> and <a href="#">21.09 SpeedRef min abs</a> .
Torque reference	FBA REF / 65536 (value in %)	Final reference is limited by torque limit parameters <a href="#">20.06...20.10</a> .

■ State diagram

The following presents the state diagram for the FBA communication profile. For other profiles, see the User's Manual of the appropriate fieldbus adapter module.

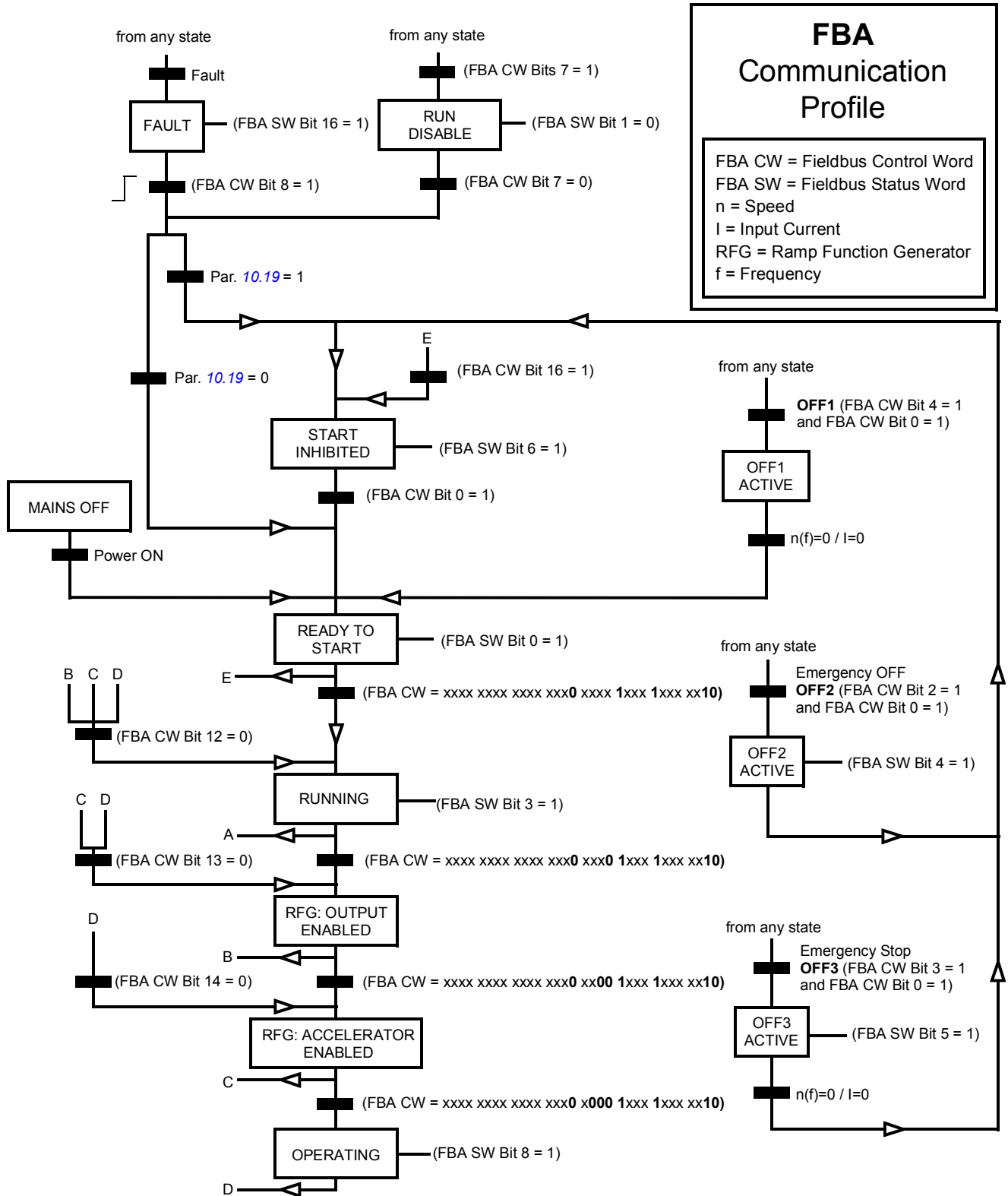







# Control block diagrams

---

## What this chapter contains

The chapter contains a graphical representation of the control program.

---

# Speed feedback

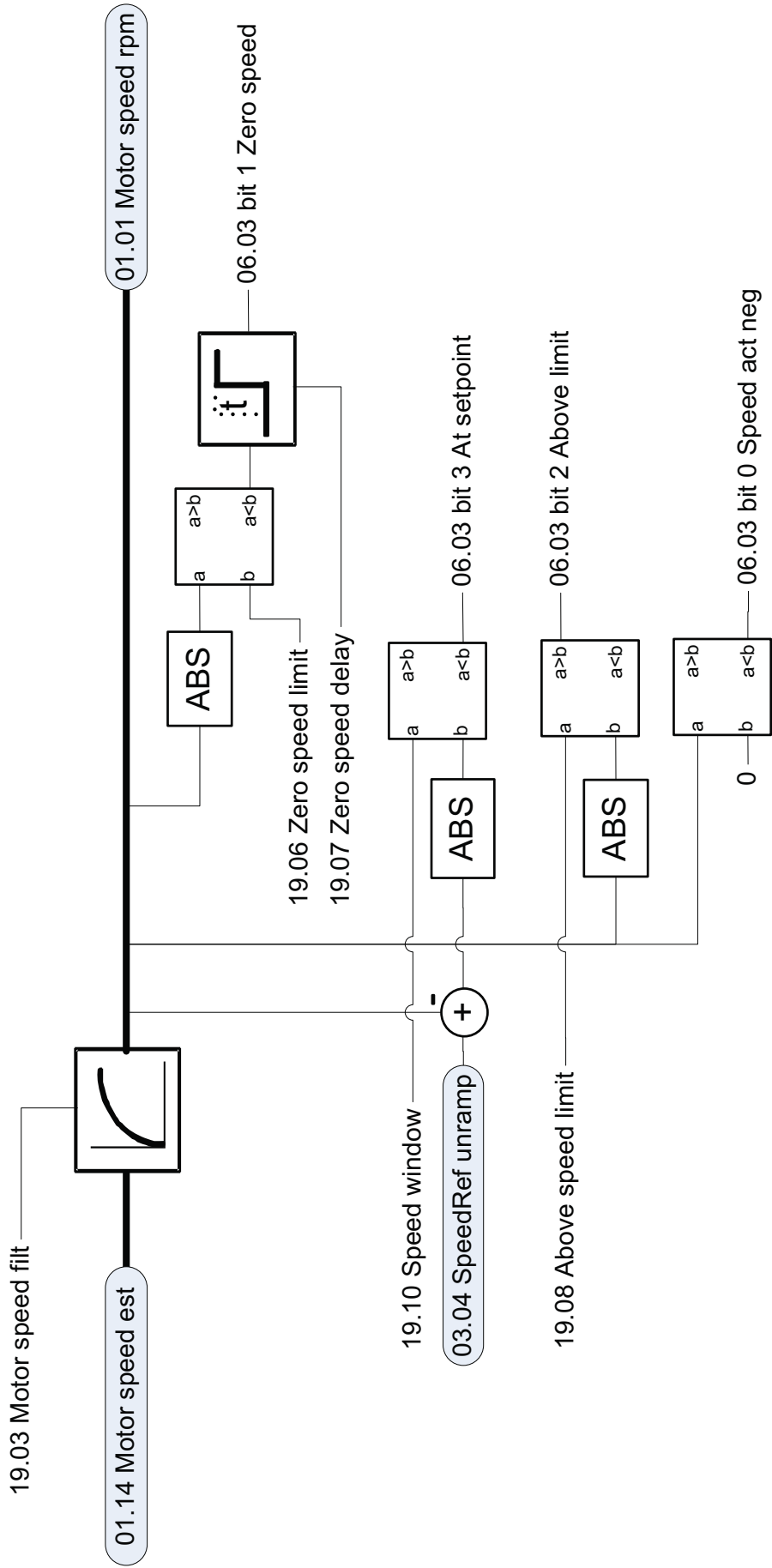



# Speed error handling

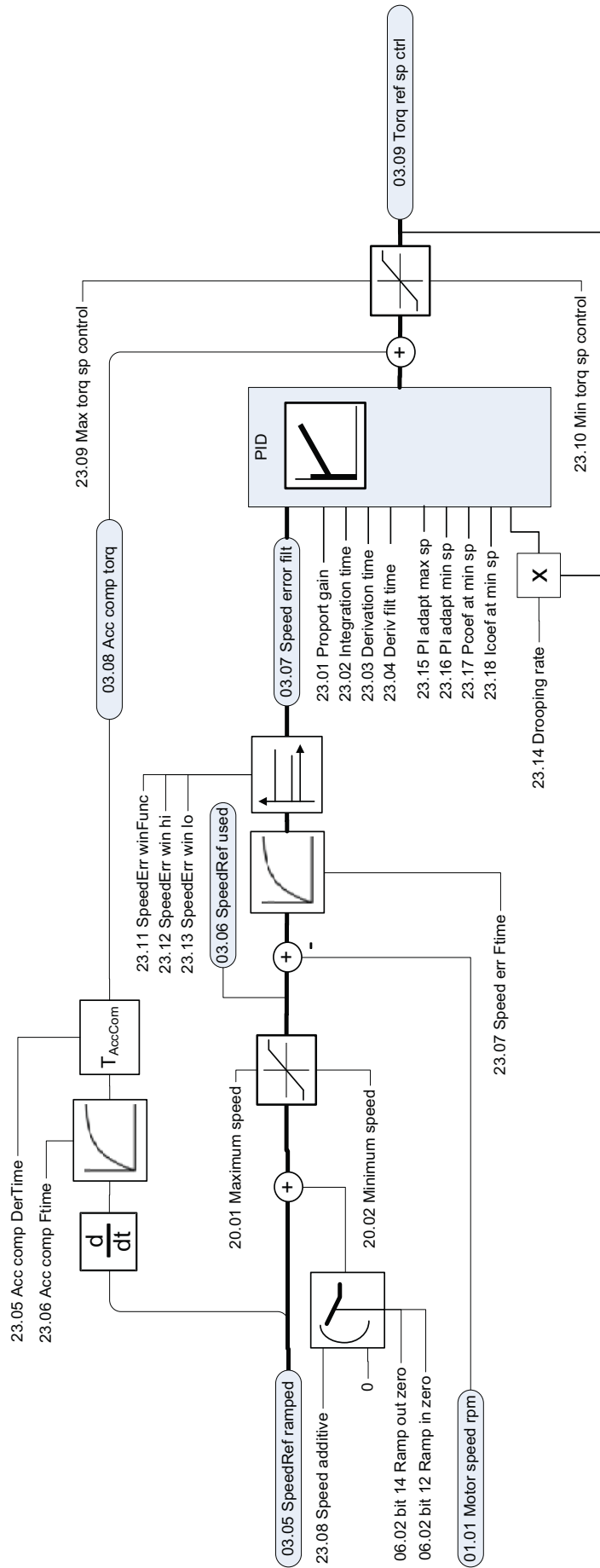

## Torque reference modification, operating mode selection

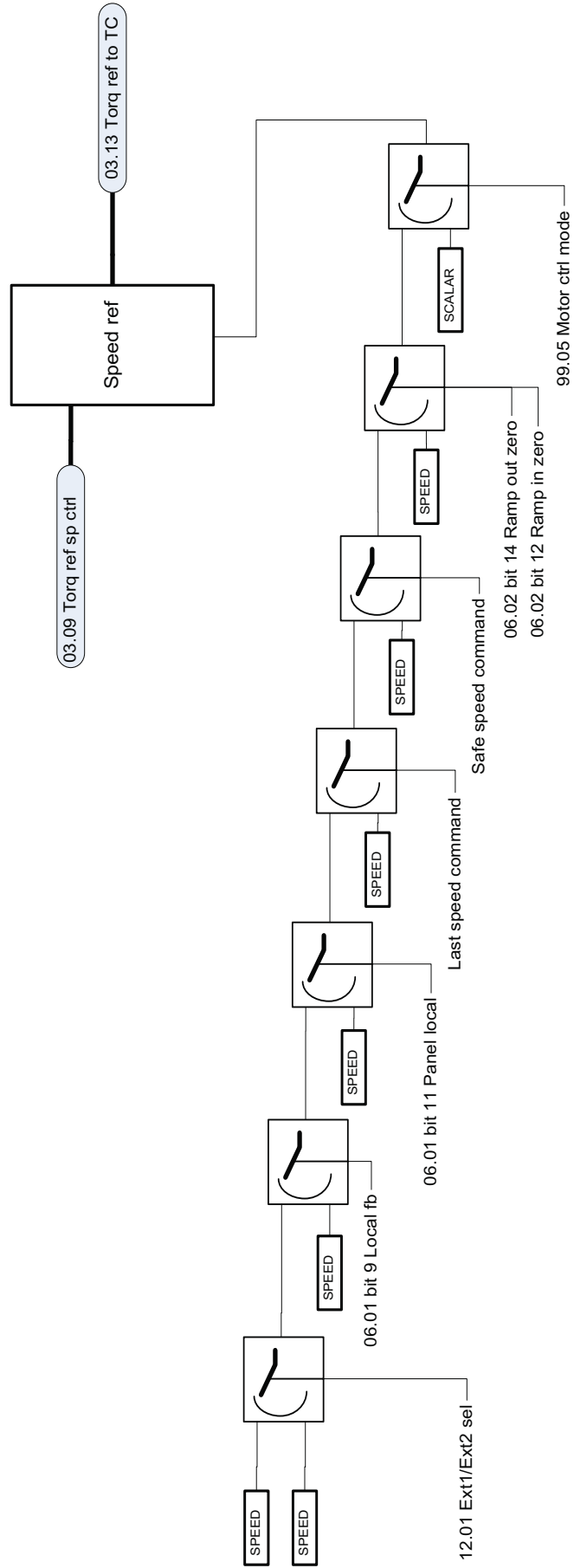

# Process PID control setpoint and actual value selection

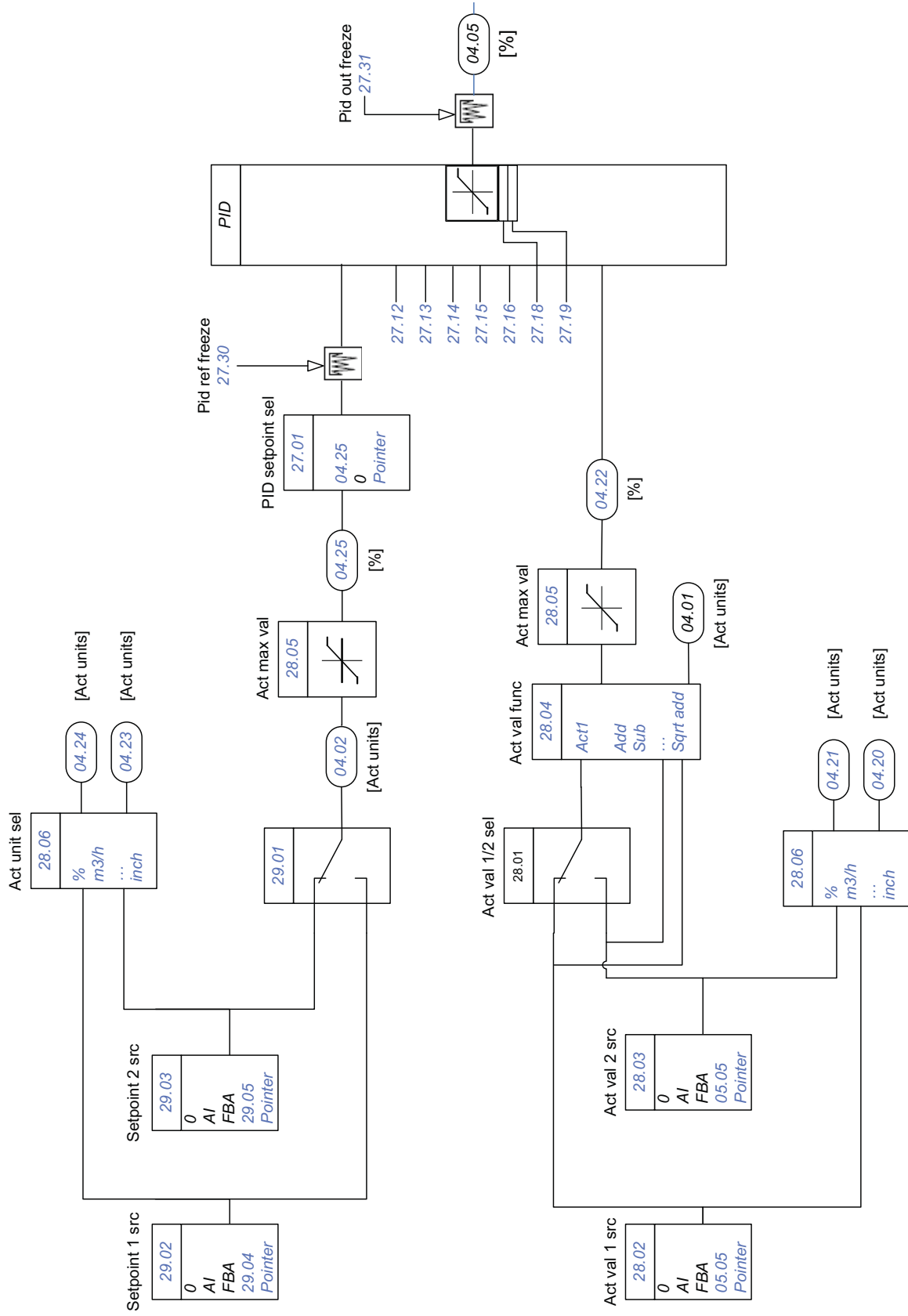

# Direct torque control

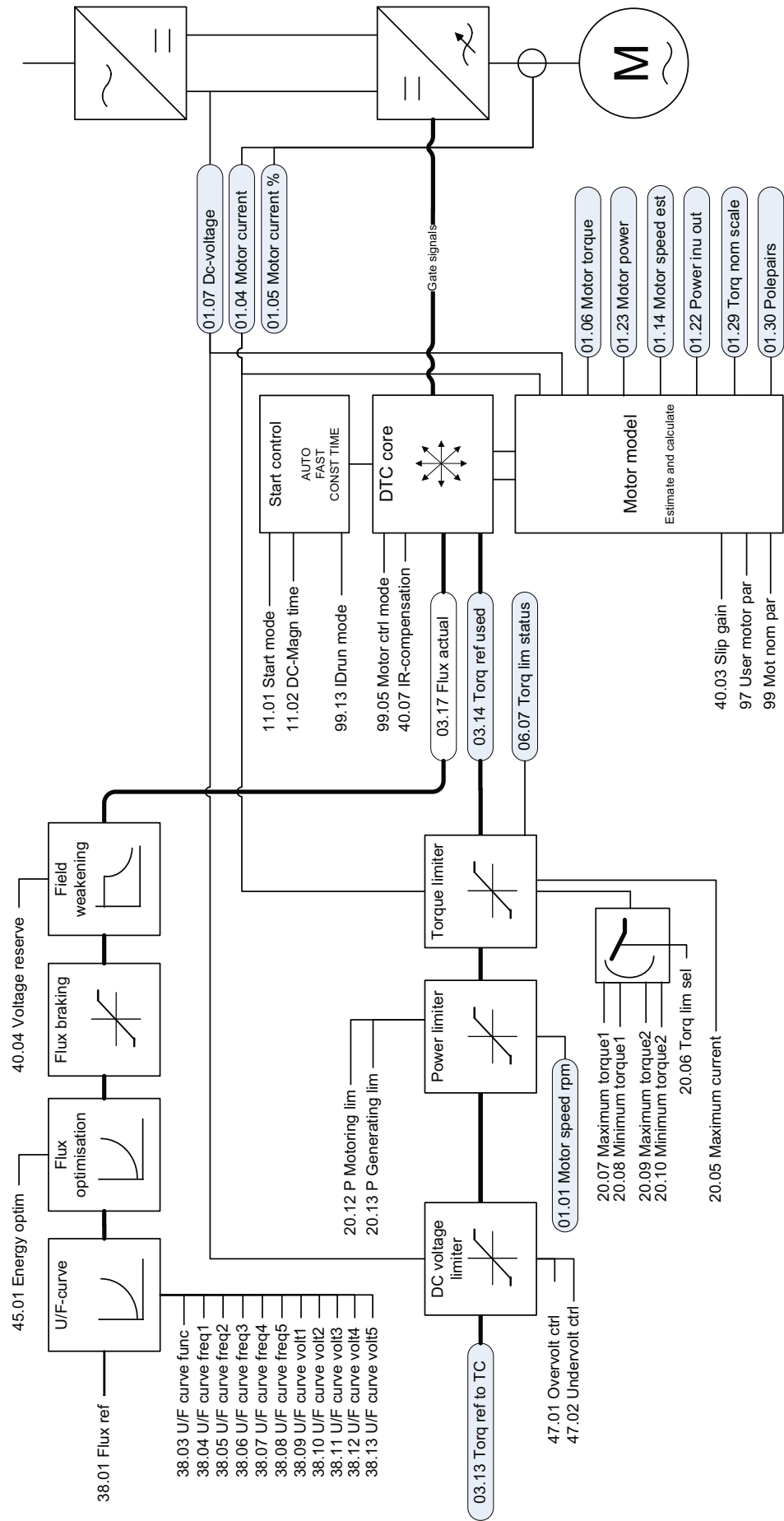





## Further information

### Product and service inquiries

Address any inquiries about the product to your local ABB representative, quoting the type designation and serial number of the unit in question. A listing of ABB sales, support and service contacts can be found by navigating to [www.abb.com/searchchannels](http://www.abb.com/searchchannels).

### Product training

For information on ABB product training, navigate to [www.abb.com/drives](http://www.abb.com/drives) and select *Training courses*.

### Providing feedback on ABB Drives manuals

Your comments on our manuals are welcome. Go to [www.abb.com/drives](http://www.abb.com/drives) and select *Document Library – Manuals feedback form (LV AC drives)*.

### Document library on the Internet

You can find manuals and other product documents in PDF format on the Internet. Go to [www.abb.com/drives](http://www.abb.com/drives) and select *Document Library*. You can browse the library or enter selection criteria, for example a document code, in the search field.

# Contact us

[www.abb.com/drives](http://www.abb.com/drives)

[www.abb.com/drivespartners](http://www.abb.com/drivespartners)

3AUA0000055144 Rev E (EN) EFFECTIVE: 2014-03-17