

Analog signal converters

Product group picture

4



Analog signal converters

Table of contents

Analog signal converter

Analog signal converters	4/2
Table of contents	4/2
Overview	4/3
Analog signal converters - CC-E range	4/5
Benefits and advantages	4/5
Ordering details - Standard signal converters	4/6
Ordering details - Thermocouple converters	4/8
Ordering details - Measuring converters	4/9
DIP switch settings, Dimensional drawings	4/10
Wiring instructions	4/11
Technical data	4/12
Analog signal converters - CC-U range	4/15
Overview	4/15
Ordering details	4/17
Ordering details - Accessories	4/18
DIP switch settings	4/19
Wiring instructions	4/21
Technical information	4/22
Technical data	4/25
Technical diag., Connection diag., Dimensional drawings	4/28

Analog signal converters

Overview

CC-E range



4

- Universally configurable devices and single-function devices
- Adjustment and operating elements on the front side
- Safe operation by electrical 3-way isolation
- Unambiguous and clear connecting terminal markings

Conversion, measurement and separation of

- Standard signals (0-5 V, 0-10 V, 0-20 mA, 4-20 mA)
- Temperature signals of RTD sensors (PT 100)
- Thermocouple signals (types J and K)
- Current measurement signals (0-5 A, 0-20 A AC/DC)

Characteristics of single-function devices

- No adjustment or balancing necessary.

Characteristics of universal devices

- The required input and output ranges can be configured by means of directly accessible DIP switches positioned on the side
- Gain adjustment of $\pm 5\%$ by means of an adjustment potentiometer on the front-side
- Offset adjustment of $\pm 5\%$ by means of adjustment potentiometers on the front-side

CC-U range



- 8 different standard signal outputs on one device
- Input and output side universally configurable
- Also available with 2 threshold relay outputs
- Adjustment and operating elements on the front side
- Safe operation by electrical 3-way isolation
- Plug-in connecting terminals, unambiguously and clearly marked

Conversion, measurement and separation of

- Standard signals
- Signals of RTD sensors (PT10, PT100, PT1000)
- Thermocouple signals
- TRMS values of currents and voltages

Characteristics

- The required input and output ranges can be configured for all devices by means of directly accessible DIP switches positioned on the side.
- Due to the wide input range of the gain and offset stages all input signals between the minimum and the maximum input value can be universally converted to all common output signals.
- Devices for DC or AC (50/60 Hz) supply available

Analog signal converters

Overview

Applications for analog signal processing and correct solution using CC-E and CC-U converters

Nearly every process includes a control system that receives data by means of analog signals and then evaluates the data and sets the respective parameters correspondingly. When transmitting analog signals numerous problems may arise which can disturb or even block an ideal behavior of the process.

Below we have listed some processing problems together with the respective solutions to solve these problems:

Signal conversion

Sometimes the available signals cannot be processed by the controller or the actuator. In this case, signal converters are required to convert the input signal (or different input signals) to the desired output signal.

Signal amplification

If long lines or high burdens have to be operated, it may be necessary to amplify the signal. CC analog signal converters require only low input power and provide high output power. Thus, there are no restrictions for the converter's position on the line, i.e. it can be used

- for signal refreshing (1) at the end of the line (low input power)
- or for signal amplification (2) at the beginning of the line (high output power).

Signal filtering

Particularly on long lines or in rough industrial environments the signals are exposed to high electromagnetic interferences. The frequency of the coupled interference signals may be in the range of the common mains frequency (50 Hz) or even much higher (in case of frequency converters). According to the specific requirements, analog signal converters are available which provide reliable suppression of those interferences by means of an input low-pass filter.

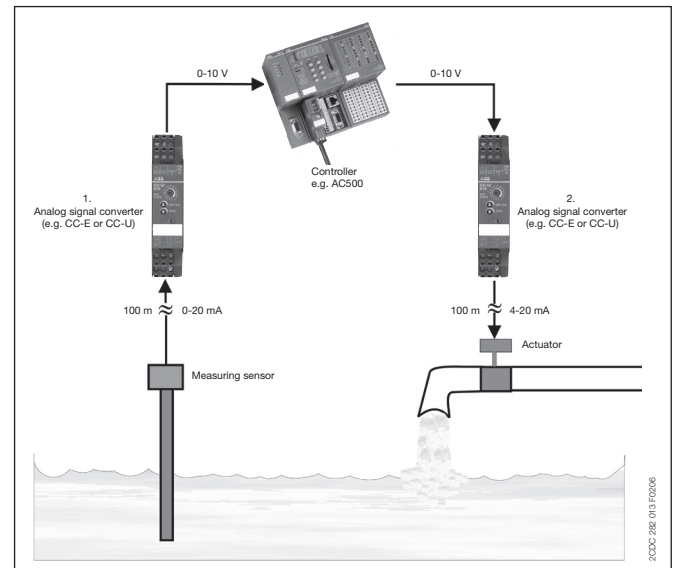

Signal separation

- Protection against overvoltage
The increased use of micro-electronics make controls much more sensitive against overvoltages, resulting from lightning discharges or switching processes. Suppression diodes are incorporated in the input of the CC analog signal converters which enable the converters to arrest overvoltages with low energy level (resulting from switching processes) by themselves. The products furthermore provide electrical isolation between input, output and supply circuit for protection of the controller connected to the output.
- Protection against ground loops
If components are used which refer to ground, the measuring signals can be falsified by a so-called ground loop. In this case, certain parts of the signal are transmitted via earth and not via the analog transmission line, thus causing incorrect evaluation of the signal. The electrical isolation between the input and the output disconnects these ground loops and thus enables correct signal transmission.

Analog signal converters - CC-E range

Benefits and advantages

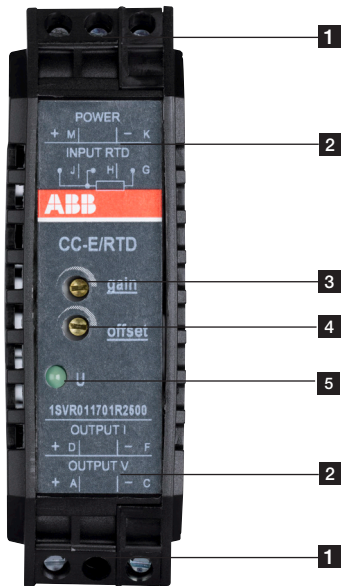

- 1 Terminals M, K, J, H, G
- 2 Terminal explanation
- 3 Adjustment of gain
- 4 Adjustment of offset
- 5 Indication of operational states
U - control supply voltage applied

4

CC-E range

- Universally configurable devices and single-function devices
- Adjustment and operating elements on the front side
- Safe operation by electrical 3-way isolation
- Unambiguous and clear connecting terminal markings

Conversion, measurement and separation of

- Standard signals (0-5 V, 0-10 V, 0-20 mA, 4-20 mA)
- Temperature signals of RTD sensors (PT 100)
- Thermocouple signals (types J and K)
- Current measurement signals (0-5 A, 0-20 A AC/DC)

Characteristics of single-function devices

- No adjustment or balancing necessary.

Characteristics of universal devices

- The required input and output ranges can be configured by means of directly accessible DIP switches positioned on the side
- Gain adjustment of $\pm 5\%$ by means of an adjustment potentiometer on the front-side
- Offset adjustment of $\pm 5\%$ by means of adjustment potentiometers on the front-side

CC-E/STD analog signal converter with 3-way electrical isolation

- 2 universally configurable devices (type CC-E/STD)
- 2x10 single-function devices
- "Plug and Work", no adjustment of single-function devices required

CC-E/TC analog signal converter for thermocouple signals of the types J and K with 3-way electrical isolation

- 2 universally configurable devices (type CC-E/TC)
- 2x6 single-function devices
- "Plug and Work", no adjustment of single-function devices required
- Integrated cold-junction compensation

CC-E I_{AC}/ILPO measuring converter without auxiliary power for sinusoidal currents 0-1 A, 0-5 A, output 4-20 mA

- Measuring converter for sinusoidal currents (0-1 A, 0-5 A)
- Measuring range selection by front-face sliding switch
- 4-20 mA output current in proportion to input current
- no additional power supply required

CC-E/RTD temperature signal converter for RTD sensors, linearized with 3-way electrical isolation

- 2 universally configurable devices (type CC-E/RTD)
- 2x12 single-function devices
- "Plug and Work", no adjustment of single-function devices required
- Temperature signal converter for PT100 sensors
- 2- or 3-wire connection

CC-E/I measuring converter for current signals 0-5 A, 0-20 A, AC/DC with 3-way electrical isolation

- 2 universally configurable devices (type CC-E/I)
- 2x6 single-function devices
- "Plug and Work", no adjustment of single-function devices required

Loop-powered current/current isolator without external power supply for analog current signals of 0-20 mA and 4-20 mA

- Electrical isolation between input and output
- Very low internal voltage drop $\leq 2.5\text{ V}$
- Available with one or two independent channels
- Width only 18 mm (1 and 2 channels)

Analog signal converters - CC-E range

Ordering details - Standard signal converters



CC-E/I

2CDC 281 010 F0003



CC-E V/V

2CDC 281 001 F0003



CC-E I/I-2

2CDC 281 041 F0003

Ordering details - Standard signal converters

Supply voltage range	Input signal	Output signal	Type	Order code	Price 1 pc	Weight (1 pc) kg (lb)	
24 V DC	0-5 V, 0-10 V, 0-20 mA, 4-20 mA	0-5 V, 0-10 V, 0-20 mA, 4-20 mA	CC-E/STD	1SVR011700R0000		0.088 (0.194)	
		0-10 V	CC-E V/V	1SVR011710R2100		0.083 (0.183)	
	0-10 V	0-20 mA	CC-E V/I	1SVR011711R1600		0.084 (0.185)	
		4-20 mA	CC-E V/I	1SVR011712R1700		0.084 (0.187)	
	0-20 mA	0-10 V	CC-E I/V	1SVR011713R1000		0.082 (0.181)	
		0-20 mA	CC-E I/I	1SVR011714R1100		0.084 (0.187)	
		4-20 mA	CC-E I/I	1SVR011715R1200		0.084 (0.185)	
		0-10 V	CC-E I/V	1SVR011716R1300		0.084 (0.185)	
		0-20 mA	CC-E I/I	1SVR011717R1400		0.084 (0.187)	
		4-20 mA	CC-E I/I	1SVR011718R2500		0.082 (0.181)	
	110-240 V AC	0-5 V, 0-10 V, 0-20 mA, 4-20 mA	0-5 V, 0-10 V, 0-20 mA, 4-20 mA	CC-E/STD	1SVR011705R2100		0.090 (0.198)
			0-10 V	CC-E V/V	1SVR011720R2300		0.096 (0.212)
0-10 V		0-20 mA	CC-E V/I	1SVR011721R1000		0.087 (0.192)	
		4-20 mA	CC-E V/I	1SVR011722R1100		0.091 (0.200)	
0-20 mA		0-10 V	CC-E I/V	1SVR011723R1200		0.091 (0.200)	
		0-20 mA	CC-E I/I	1SVR011724R1300		0.088 (0.194)	
4-20 mA		4-20 mA	CC-E I/I	1SVR011725R1400		0.088 (0.194)	
		0-10 V	CC-E I/V	1SVR011726R1500		0.096 (0.212)	
		0-20 mA	CC-E I/I	1SVR011727R1600		0.087 (0.192)	
		4-20 mA	CC-E I/I	1SVR011728R2700		0.088 (0.194)	
loop powered		-10...+10 V	-10...+10 V	CC-E V/V	1SVR011729R2000		0.086 (0.190)
		0-20 mA, 4-20 mA	0-20 mA, 4-20 mA	CC-E I/I-1 ¹⁾	1SVR010200R1600		0.038 (0.084)
	CC-E I/I-2 ¹⁾			1SVR010201R0300		0.044 (0.097)	

¹⁾ CC-E-I/I-1 has 1 channel, CC-E-I/I-2 has 2 channels



Further documentation analog
signal converters CC-E on
www.abb.com

Analog signal converters - CC-E range

Ordering details - RTD converters



CC-E/RTD

2CDC281 004 F0003

4

Ordering details - RTD converters

Supply voltage range	Input signal	Output signal	Type	Order code	Price 1 pc	Weight (1 pc) kg (lb)	
24 V DC	1)	0-10 V, 0-20 mA, 4-20 mA	CC-E/RTD	1SVR011701R2500		0.091 (0.200)	
	PT100 0...100 °C	0-10 V	CC-E RTD/V	1SVR011730R2500		0.084 (0.185)	
		0-20 mA	CC-E RTD/I	1SVR011731R1200		0.086 (0.190)	
		4-20 mA	CC-E RTD/I	1SVR011732R1300			
	PT100 -50...+50 °C	0-10 V	CC-E RTD/V	1SVR011733R1400		0.083 (0.183)	
		0-20 mA	CC-E RTD/I	1SVR011734R1500		0.084 (0.185)	
		4-20 mA	CC-E RTD/I	1SVR011735R1600		0.084 (0.187)	
	PT100 0...300 °C	0-10 V	CC-E RTD/V	1SVR011736R1700		0.084 (0.185)	
		0-20 mA	CC-E RTD/I	1SVR011737R1000		0.084 (0.187)	
		4-20 mA	CC-E RTD/I	1SVR011738R2100		0.101	
	PT100 -50...+250 °C	0-10 V	CC-E RTD/V	1SVR011739R2200		0.084 (0.185)	
		0-20 mA	CC-E RTD/I	1SVR011740R0700		0.084 (0.187)	
	110-240 V AC	refer to table ¹⁾	0-10 V, 0-20 mA, 4-20 mA	CC-E/RTD	1SVR011706R2200		0.093 (0.205)
		PT100 0...100 °C	0-10 V	CC-E RTD/V	1SVR011788R2400		0.086 (0.190)
0-20 mA			CC-E RTD/I	1SVR011789R2500		0.088 (0.194)	
4-20 mA			CC-E RTD/I	1SVR011790R2200		0.089 (0.196)	
PT100 -50...+50 °C		0-10 V	CC-E RTD/V	1SVR011791R1700		0.087 (0.192)	
		0-20 mA	CC-E RTD/I	1SVR011792R1000		0.089 (0.196)	
		4-20 mA	CC-E RTD/I	1SVR011793R1100			
PT100 0...300 °C		0-10 V	CC-E RTD/V	1SVR011794R1200		0.087 (0.192)	
		0-20 mA	CC-E RTD/I	1SVR011795R1300		0.089 (0.196)	
		4-20 mA	CC-E RTD/I	1SVR011796R1400			
PT100 -50...+250 °C		0-10 V	CC-E RTD/V	1SVR011797R1500		0.086 (0.190)	
		0-20 mA	CC-E RTD/I	1SVR011798R2600		0.089 (0.196)	
		4-20 mA	CC-E RTD/I	1SVR011799R2700		0.088 (0.194)	

¹⁾ Refer to "Technical data" on page 4/12.



Further documentation analog
signal converters CC-E on
www.abb.com

Analog signal converters - CC-E range

Ordering details - Thermocouple converters



CC-E TC

2C2DC 281 007 F00X3

Ordering details - Thermocouple converters

Supply voltage range	Input signal	Output signal	Type	Order code	Price 1 pc	Weight (1 pc) kg (lb)
24 V DC	thermocouple types J and K	0-10 V, 0-20 mA, 4-20 mA	CC-E/TC	1SVR011702R2600		0.089 (0.196)
	type J 0...600 °C	0-10 V	CC-E TC/V	1SVR011750R0100		0.087 (0.192)
		0-20 mA	CC-E TC/I	1SVR011751R2600		0.084 (0.187)
		4-20 mA	CC-E TC/I	1SVR011752R2700		0.102
		0-10 V	CC-E TC/V	1SVR011753R2000		0.084 (0.185)
	type K 0...1000 °C	0-20 mA	CC-E TC/I	1SVR011754R2100		0.086 (0.190)
		4-20 mA	CC-E TC/I	1SVR011755R2200		0.088 (0.194)
		thermocouple types J and K	0-10 V, 0-20 mA, 4-20 mA	CC-E/TC	1SVR011707R2300	
0-10 V			CC-E TC/V	1SVR011760R0300		0.088 (0.194)
110-240 V AC	type J 0...600 °C	0-20 mA	CC-E TC/I	1SVR011761R2000		0.1 (0.220)
		4-20 mA	CC-E TC/I	1SVR011762R2100		0.086 (0.190)
	type K 0...1000 °C	0-10 V	CC-E TC/V	1SVR011763R2200		0.088 (0.194)
		0-20 mA	CC-E TC/I	1SVR011764R2300		0.086 (0.190)
		0-20 mA	CC-E TC/I	1SVR011765R2400		0.088 (0.194)
		4-20 mA	CC-E TC/I	1SVR011765R2400		0.086 (0.190)



Further documentations analog signal converters CC-E on www.abb.com

Analog signal converters - CC-E range

Ordering details - Measuring converters



2CDC 281 018 F0004

CC-E I_{AC}/I_{LPO}

4

Ordering details - Measuring converters

Supply voltage range	Input signal	Output signal	Type	Order code	Price 1 pc	Weight (1 pc) kg (lb)
24 V DC	0-5 A, 0-20 A, AC/DC	0-10 V, 0-20 mA, 4-20 mA	CC-E/I	1SVR011703R2700		0.096 (0.212)
	0-5 A, 0-20 A, AC	0-10 V	CC-E I_{AC}/V	1SVR011770R0500		0.090 (0.198)
		0-20 mA	CC-E I_{AC}/I	1SVR011771R2200		0.092 (0.203)
		4-20 mA	CC-E I_{AC}/I	1SVR011772R2300		0.092 (0.207)
	0-5 A, 0-20 A, DC	0-10 V	CC-E I_{DC}/V	1SVR011773R2400		0.091 (0.200)
		0-20 mA	CC-E I_{DC}/I	1SVR011774R2500		0.093 (0.205)
110-240 V AC	0-5 A, 0-20 A, AC/DC	0-10 V, 0-20 mA, 4-20 mA	CC-E/I	1SVR011708R0400		0.099 (0.218)
	0-5 A, 0-20 A, AC	0-10 V	CC-E I_{AC}/V	1SVR011780R1100		0.092 (0.203)
		0-20 mA	CC-E I_{AC}/I	1SVR011781R0600		0.092 (0.207)
		4-20 mA	CC-E I_{AC}/I	1SVR011782R0700		0.093 (0.205)
	0-5 A, 0-20 A, DC	0-10 V	CC-E I_{DC}/V	1SVR011783R0000		0.095 (0.209)
		0-20 mA	CC-E I_{DC}/I	1SVR011784R0100		0.095 (0.209)
loop powered	0-1 A, 0-5 A, AC	4-20 mA	CC-E I_{AC}/I_{LPO} ¹⁾	1SVR010203R0500		0.052 (0.115)

¹⁾ for sinusoidal currents



Further documentation analog signal converters CC-E on www.abb.com

Analog signal converters - CC-E range

DIP switch settings, Dimensional drawings

CC-E/STD, CC-E x/x (universal devices)

Input	Output	Switch							
		1	2	3	4	5	6	7	8
0...5 V	0...5 V								
	0...10 V								
	0...20 mA								
	4...20 mA								
0...10 V	0...5 V								
	0...10 V								
	0...20 mA								
	4...20 mA								
0...20 mA	0...5 V								
	0...10 V								
	0...20 mA								
	4...20 mA								
4...20 mA	0...5 V								
	0...10 V								
	0...20 mA								
	4...20 mA								

2CDC 282 001 F0204

Legend	
■	ON
□	OFF

2CDC 282 002 F0204

CC-E/RTD

Input	Output	Switch					
		1	2	3	4	5	6
0...100 °C	0...10 V						
	0-20 mA						
	4-20 mA						
0...300 °C	0-10 V						
	0-20 mA						
	4-20 mA						
0...500 °C	0-10 V						
	0-20 mA						
	4-20 mA						
-50...+50 °C	0-10 V						
	0-20 mA						
	4-20 mA						
-50...+250 °C	0-10 V						
	0-20 mA						
	4-20 mA						
-50...+450 °C	0-10 V						
	0-20 mA						
	4-20 mA						
High fail safe							
Low fail safe							

2CDC 282 006 F0208

Legend	
■	ON
□	OFF
□	no influence

2CDC 282 003 F0204

CC-E/TC

Input	Output	Switch					
		1	2	3	4	5	6
TC-J: 0...600 °C	0...10 V						
	0...20 mA						
	4...20 mA						
TC-K: 0...1000 °C	0...10 V						
	0...20 mA						
	4...20 mA						
High fail safe							
Low fail safe							

2CDC 282 007 F0208

Legend	
■	ON
□	OFF
□	no influence

2CDC 282 003 F0204

CC-E/I

Input	Output	Switch					
		1	2	3	4	5	6
I - DC	0...10 V						
I - AC	0...20 mA						
I - DC	4...20 mA						
I - AC	4...20 mA						

2CDC 282 005 F0208

Legend	
■	ON
□	OFF

2CDC 282 002 F0204

Input range selection - CC-E/I

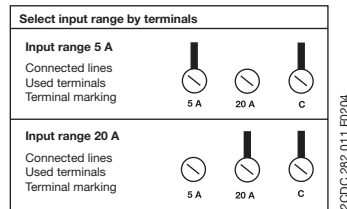

2CDC 282 011 F0204

Dimensional drawings

CC-E/x

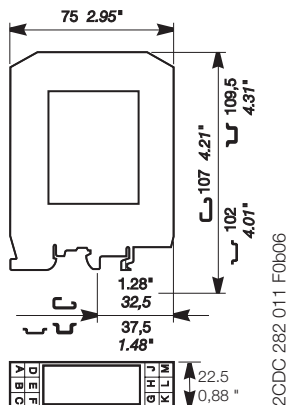

CC-E I_{AC}/ILPO, CC-E I/I

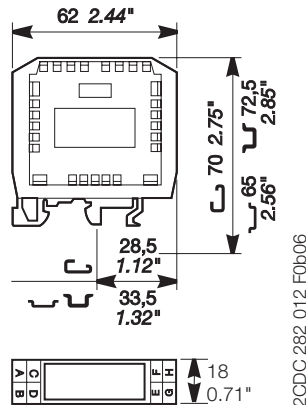

Analogue signal converters - CC-E range

Wiring instructions

CC-E/STD, CC-E x/x (universal devices)

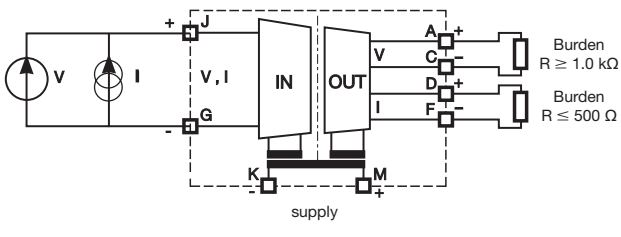

2CDC 282 006 F0206

CC-E/RTD

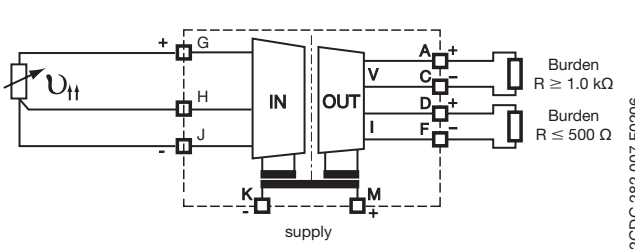

2CDC 282 007 F0206

CC-E/TC

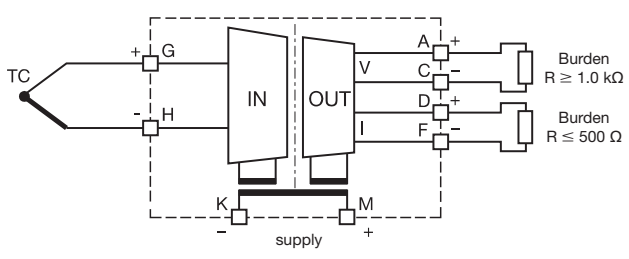

2CDC 282 008 F0206

CC-E I_{AC}/ILPO

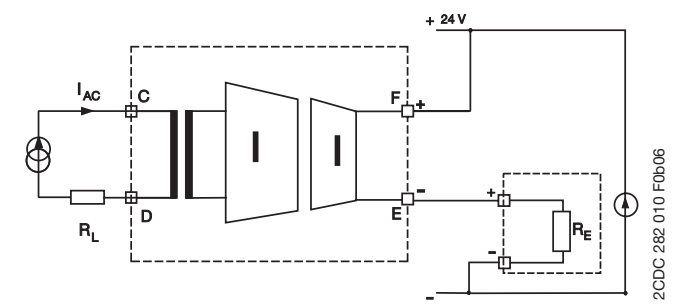

2CDC 282 010 F0b06

CC-E I/I-1

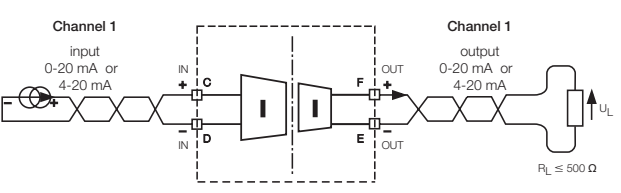

2CDC 282 003 F0205

CC-E I/I-2

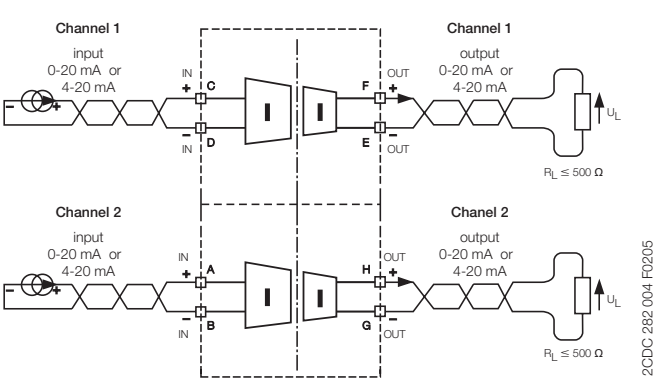

2CDC 282 004 F0205

CC-E I/I

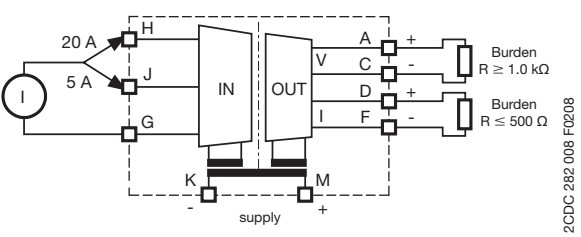

2CDC 282 008 F0208

Analog signal converters - CC-E range

Technical data

Type	CC-E/STD / CC-E x/x	CC-E/RTD	CC-E/TC
Input circuits - Analog inputs	J-G-H	Current	Voltage
Input signal	standard signals	Temperature sensors	Thermocouples (IEC/EN 60584-1)
Rated input range	0...20 mA / 0...5 V / 4...20 mA / 0...10 V / -10...+10 V	PT100 ¹⁾	TC.K, TC.J
Limitation of input signals	+55 mA	-50...+500 °C	TC.K: 0...1000 °C, TC.J: 0...600 °C
Influence of line resistance	± 11 V	< 0.01 %/Ω	< 0.5 % / 100 Ω
Gain adjustment range	± 5 % (universal devices)	-	-
Offset adjustment range	± 5 % (universal devices)	-	-
Input impedance	50 Ω	1 MΩ	-
Suppression at 50 Hz	-	-	> 35 dB
Common-mode rejection	-	100 dB	-
Output circuits - Analog outputs	D-F, A-C	Current	Voltage
Output signal	0-20 mA, 4-20 mA	-	0-5 V, 0-10 V
Output burden	≤ 500 Ω	-	≥ 1.0 kΩ
Accuracy ²⁾	± 0.5 % of full-scale	-	-
Residual ripple	< 0.5 %	-	-
Response time	200 μs	10 ms	-
Transmission frequency	2 kHz	80 Hz	2 Hz (up to -3 dB)
Reaction to input circuit interruption	-	high fail safe: output voltage > 115 % of measuring range ³⁾ low fail safe: output voltage < -0.6 V, output current = 0 mA	-
Supply circuits	K-M	DC versions	AC versions
Supply voltage	24 V DC	-	110-240 V AC - 50/60 Hz
Supply voltage tolerance	-15...+15 %	-	-15...+10 %
Power consumption	1.5 W typ.	-	1.5 VA typ.
Indication of operational states			
Rated control supply voltage U _s		U: green LED	
General data			
Ambient temperature range operation / storage	0...+60 °C / -20...+80 °C		
Temperature coefficient	± 500 ppm/°C		
Mounting	DIN rail (IEC/EN 60715), snap-on mounting		
Mounting position	ventilation slots on top and bottom		
Degree of protection	IP20		
Electrical connection			
Connecting capacity	rigid 0.2-4 mm ² (24-12 AWG) fine-strand with(out) wire end 0.2-2.5 mm ² (24-14 AWG) ferrule		
Stripping length	7 mm (0.28 inch)		
Tightening torque	0.5 Nm (4.4 lb.in)		
Isolation data			
Test voltage between all isolated circuits	2.5 kV AC		
Rated insulation voltage	-		
Standards / Directives			
Standards	EN 50178		
Low Voltage Directive	2014/35/EU		
EMC Directive	2014/30/EU		
RoHS Directive	2011/65/EU		
Electromagnetic compatibility			
Interference immunity to	IEC/EN 61000-6-2		
electrostatic discharge	IEC/EN 61000-4-2 level 3 (±6 kV / ±8 kV)		
radiated, radio-frequency, electromagnetic field	IEC/EN 61000-4-3 10 V/m (with high frequency disturbance, the function or the accuracy might be temporarily degraded)		
electrical fast transient / burst	IEC/EN 61000-4-4 level 3 (±2 kV / 5 kHz)		
surge	IEC/EN 61000-4-5 ±2 kV / ±1 kV		
conducted disturbances, induced by radio-frequency fields	IEC/EN 61000-4-6 10 V		
Interference emission	IEC/EN 61000-6-4		
high-frequency radiated	IEC/CISPR 11, EN 55011 class B		
high-frequency conducted	IEC/CISPR 11, EN 55011 class B		

¹⁾ When connecting a 2-wire sensor, the terminals J and H have to be jumpered.

²⁾ Includes non-linearity and factory setting, influenced by supply voltage and output load.

³⁾ Only -/RTD and -/TC: Single-function devices respond with Low fail safe to input signal interruptions.

Analog signal converters - CC-E range

Technical data

4

Type	CC-E I/I-1 / CC-E I/I-2	
Input circuits - Analog inputs		
Current		
Input current I_{IN}	0-20 mA, 4-20 mA	
Min. input current	< 100 μ A	
Max. input current	$U_{IN} < 18$ V	50 mA
Input voltage U_{IN}	< 2.5 V + ($I_{IN} \times R_i$)	
Input voltage drop U_i	20 mA, $R_L = 0 \Omega$	< 2.5 V
Max. input voltage	$I_{IN} < 50$ mA	18 V
Output circuits		
Output current I_{OUT}	0-20 mA, 4-20 mA	
Output load R_L	0-500 Ω	
Output voltage U_{OUT}	$I_{OUT} \times R_L$	
Residual ripple	500 Ω , 20 mA	< 20 mV _{PP}
Response time (0-100 %)	0-500 Ω , 20 mA	< 15 ms
	500 Ω , 20 mA, 25 °C	< 5 ms
Accuracy	≤ 0.1 % of full-scale (20 mA)	
Load influence (0-500 Ω)	$\leq \pm 0.05$ % / 100 Ω ,	
	≤ -0.1 % / 100 Ω (25 °C)	
General data		
Width of the enclosure	18 mm	
Mounting	DIN rail (IEC/EN 60715)	
Mounting position	any	
Degree of protection	enclosure / terminals	IP20 / IP20
Electrical connection		
Connecting capacity	rigid	0.2-4 mm ² (24-12 AWG)
	fine-strand with(out) wire end ferrule	0.2-2.5 mm ² (24-14 AWG)
Stripping length	7 mm (0.28 inch)	
Tightening torque	0.5 Nm (4.4 lb.in)	
Environmental data		
Ambient temperature range	operation / storage	-25...+60 °C / -40...+85 °C
Temperature coefficient	< ± 50 ppm / °C	
Vibration (IEC/EN 60068-2-6)	operational withstand	4 g 2-100 Hz
	mechanical withstand	10 g 55 Hz
Damp heat, cyclic (IEC/EN 60068-2-30)	Test Db: 55 °C, 95 % RH, 2 cycles	
Isolation data		
Insulation voltage input / output	500 V _{eff} / 50 Hz	
Insulation voltage between channels	5 kV _{eff} / 50 Hz (device with 2 channels)	
Pollution category	2	
Overvoltage category	II	
Standards / Directives		
Standards	EN 50178	
Low Voltage Directive	2014/35/EU	
EMC Directive	2014/30/EU	
RoHS Directive	2011/65/EU	
Electromagnetic compatibility		
Interference immunity to	IEC/EN 61000-6-2	
electrostatic discharge	EN 61000-4-2	level 3 (± 6 kV / ± 8 kV)
radiated, radio-frequency, electromagnetic field	EN 61000-4-3	10 V/m (with high frequency disturbance, the function or the accuracy might be temporarily degraded)
electrical fast transient / burst	EN 61000-4-4	level 3 (± 2 kV / 5 kHz)
surge	EN 61000-4-5	± 2 kV / ± 1 kV
conducted disturbances, induced by radio-frequency fields	EN 61000-4-6	10 V
power frequency magnetic fields	EN 61000-4-8	30 A/m
Interference emission	IEC/EN 61000-6-4	
high-frequency radiated	IEC/CISPR 11, EN 55011	class B
high-frequency conducted	IEC/CISPR 11, EN 55011	class B

Analog signal converters - CC-E range

Technical data

Type	CC-E/I J-G-H		CC-E I _{Ac} /ILPO C-D
	AC current	DC current	2 meas. ranges selectable
Input circuits - Analog inputs			
Rated input range	0-5 A / 0-20 A	0-5 A / 0-20 A	0-1 A / 0-5 A / sinusoidal
Measuring frequency			50/60 Hz
Overload capacity of inputs	input range 1 10 x I _{Nom.} (50 A) for max. 1 s		10 x I _{Nom.} (50 A) for max. 2 s
	input range 2 10 x I _{Nom.} (200 A) for max. 1 s		10 x I _{Nom.} (200 A) for max. 2 s
Gain adjustment range	±5 % (universal devices)		-
Offset adjustment range	±5 % (universal devices)		-
Input impedance / resistance	5A : 65 mΩ	20 A : 2.5 mΩ	5 mΩ
Output circuits - Analog outputs	D-F Current	A-C Voltage	F-E passive current output in proportion to input current
Output signal	0-20 mA / 4-20 mA	0-10 V	4-20 mA
Output burden / load	≤ 500 Ω	≥ 1.0 Ω	12 V DC: 150 Ω 24 V DC: 750 Ω 30 V DC: 1050 Ω
Accuracy ¹⁾	± 2 % of full-scale		
Offset adjustment range	±5 % (universal device)		± 5 %
Gain adjustment range	±5 % (universal device)		± 20 %
Residual ripple	< 0.5 %		
Response time	0.5 s		0.6 s
Transmission frequency	DC or 50/60 Hz		AC: 50/60 Hz
Reaction to input circuit interruption	Low fail safe: output voltage < 200 mV, output current < 400 μA		-
Supply circuits	K-M	DC versions	AC versions
Supply voltage		24 V DC	110-240 V AC 50/60 Hz
Supply voltage tolerance		-15...+15 %	-15...+10 %
Power consumption		typ 1.5 W	typ 1.5 VA
Indication of operational states			
Supply voltage		U: green LED	-
General data			
Ambient temperature range operation / storage	0...+60 °C / -20...+80 °C		-20...+60 °C / -40...+80 °C
Temperature coefficient	± 500 ppm/°C		300 ppm/°C
Degree of protection (DIN 40050)	IP20		
Mounting position	ventilation slots on top and bottom		
Mounting	DIN rail (IEC/EN 60715), snap-on mounting		
Electrical connection			
Connecting capacity	rigid	0.2-4 mm ² (24-12 AWG)	
	fine-strand with(out) wire end ferrule	0.2-2.5 mm ² (24-14 AWG)	
Stripping length	7 mm (0.28 inch)		
Tightening torque	0.5 Nm (4.4 lb.in)		
Isolation data			
Test voltage (between all isolated circuits)	2.5 kV AC		
Rated insulation voltage	-		250 V AC
Standards / Directives			
Standards	EN 50178		
Low Voltage Directive	2014/35/EU		
EMC Directive	2014/30/EU		
RoHS Directive	2011/65/EU		
Electromagnetic compatibility			
Interference immunity to		IEC/EN 61000-6-2	
electrostatic discharge	IEC/EN 61000-4-2	level 3 (±6 kV / ±8 kV)	
radiated, radio-frequency, electromagnetic field	IEC/EN 61000-4-3	10 V/m (with high frequency disturbance, the function or the accuracy might be temporarily degraded)	
electrical fast transient / burst surge	IEC/EN 61000-4-4	level 3 (±2 kV / 5 kH)	
conducted disturbances, induced by radio-frequency fields	IEC/EN 61000-4-5	±2 kV / ±1 kV	
	IEC/EN 61000-4-6	10 V	
Interference emission		IEC/EN 61000-6-4	
high-frequency radiated	IEC/CISPR 11, EN 55011	class	
high-frequency conducted	IEC/CISPR 11, EN 55011	class B	

¹⁾ Includes non-linearity and factory setting, influenced by supply voltage and output load.

Analog signal converters - CC-U range

Overview

CC-U range

- 8 different standard signal outputs on one device
- Input and output side universally configurable
- Also available with 2 threshold relay outputs
- Adjustment and operating elements on the front side
- Safe operation by electrical 3-way isolation
- Plug-in connecting terminals, unambiguously and clearly marked

Conversion, measurement and separation of

- Standard signals
- Signals of RTD sensors (PT10, PT100, PT1000)
- Thermocouple signals
- TRMS values of currents and voltages

Characteristics

- The required input and output ranges can be configured for all devices by means of directly accessible DIP switches positioned on the side.
- Due to the wide input range of the gain and offset stages all input signals between the minimum and the maximum input value can be universally converted to all common output signals.
- Devices for DC or AC (50/60 Hz) supply available

4

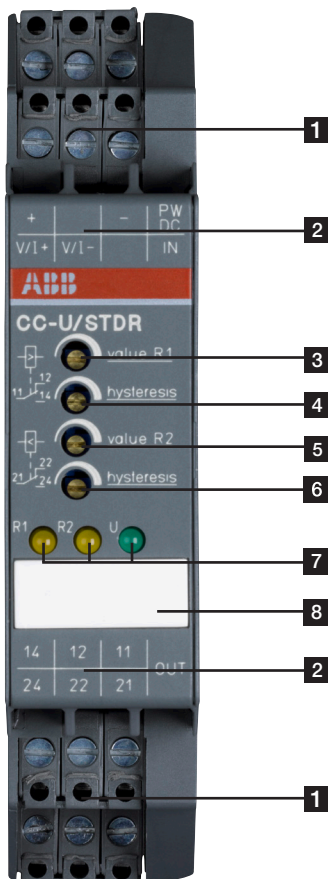

- 1** Terminals +, V/I+, V/I-, PW DC, IN, -
- 2** Terminal explanation
- 3** Adjustment of resistance value R1
- 4** Adjustment of hysteresis
- 5** Adjustment of resistance value R2
- 6** Adjustment of hysteresis
- 7** Indication of operational states
R1 yellow LED - resistance value R1
R2 yellow LED - resistance value R2
U green LED - supply voltage
- 8** Marker label

Analog signal converters - CC-U range

Overview

CC-U/STD universal signal converter with 3-way electrical isolation

- More than 120 configurations possible
- Configurable output signal response on input voltage signal interruption (low fail safe / high fail safe)
- Adjustment and operating elements on the front
- Short-circuit proof signal outputs
- Plug-in connecting terminals for inputs, outputs and supply
- Very fast signal transmission enables use in control systems

CC-U/RTD universal signal converter for PT10, PT100, PT1000 temperature sensors according to IEC/EN 60751 linearized with 3-way electrical isolation

- Configurable output signal response on input signal interruption (low / high fail safe)
- Adjustment and operating elements on the front-side
- Short-circuit proof signal outputs
- Plug-in connecting terminals for inputs, outputs and supply
- 2- or 3-wire connection

CC-U/TC universal signal converter for thermocouples with 3-way electrical isolation

- Temperature signal converter for thermocouples of the types K, J, T, S, E, N, R, B
- Continuously adjustable voltage signal input 0-10 mV and 0-50 mV
- Differential temperature meas. possible (see "Wiring instructions" on page 4/21)
- Configurable output signal response on input signal interruption (low fail safe / high fail safe)
- Adjustment and operating elements on the front-side
- Short-circuit proof signal outputs
- Plug-in connecting terminals for inputs, outputs and supply
- Cold-junction compensation selectable

CC-U/V universal measuring converter for RMS values of 0-600 V, with 3-way electrical isolation

- RMS converter for voltage signals up to 600 V of any wave form (DC, DC with superimposed AC components, pure sinusoidal, triangular, phase-angle controlled, etc. in a measuring range of 0-600 Hz)
- Adjustment and operating elements on the front
- Short-circuit proof signal outputs
- Plug-in connecting terminals for inputs, outputs and supply

CC-U/STDR universal signal converter for standard signals, with 2 threshold relay outputs and with 3-way electrical isolation

- Standard signal converter with 7 setting ranges
- 2 threshold relay outputs with one c/o contact each (threshold and respective hysteresis can be adjusted independently from each other)
- Open-circuit or closed-circuit principle configurable by means of a DIP switch
- 2 yellow LEDs for clear status indication of the output relays
- Plug-in connecting terminals for inputs, outputs and supply

CC-U/TCR universal signal converter for thermocouples, with 2 threshold relay outputs and 3-way electrical isolation

- Temperature signal converter for thermocouples of the types K, J, T, S
- 2 threshold relay outputs with one change-over contact each (threshold and respective hysteresis can be adjusted independently from each other)
- Open-circuit or closed-circuit principle configurable by means of a DIP switch
- 2 yellow LEDs for clear status indication of the output relays
- Plug-in connecting terminals for inputs, outputs and supply
- Integrated cold-junction compensation

CC-U/I universal measuring converter for RMS values of 0-1 A and 0-5 A, with 3-way electrical isolation

- RMS converter for current signals up to 1 A and up to 5 A of any wave form (DC, DC with superimposed AC components, pure sinusoidal, triangular, phase-angle controlled, etc. in a measuring range of 0-600 Hz)
- Adjustment and operating elements on the front
- Short-circuit proof signal outputs
- Plug-in connecting terminals for inputs, outputs and supply

Analog signal converters - CC-U range

Ordering details



2CDC 281 003 F0003

4 CC-U/STDR

Ordering details - Standard signal converters

Supply voltage range	Input signal	Output signal	Type	Order code	Price 1 pc	Weight (1 pc) kg (lb)
24-48 V DC, 24 V AC	refer to table	refer to table	CC-U/STD	1SVR040000R1700		0.125 (0.276)
110-240 V AC, 100-300 V DC				1SVR040001R0400		0.126 (0.278)
24-48 V DC, 24 V AC		2 c/o	CC-U/STDR ¹⁾	1SVR040010R0000		0.142 (0.313)
110-240 V AC, 100-300 V DC				1SVR040011R2500		



2CDC 281 005 F0003

CC-U/RTD

Ordering details - RTD converters

Supply voltage range	Input signal	Output signal	Type	Order code	Price 1 pc	Weight (1 pc) kg (lb)
24-48 V DC, 24 V AC	refer to table	refer to table	CC-U/RTD	1SVR040002R0500		0.126 (0.278)
110-240 V AC, 100-300 V DC				1SVR040003R0600		0.128 (0.282)



2CDC 281 008 F0003

CC-U/TC

Ordering details - Thermocouple converters

Supply voltage range	Input signal	Output signal	Type	Order code	Price 1 pc	Weight (1 pc) kg (lb)
24-48 V DC, 24 V AC	refer to table	refer to table	CC-U/TC	1SVR040004R0700		0.130 (0.287)
110-240 V AC, 100-300 V DC				1SVR040005R0000		0.128 (0.282)
24-48 V DC, 24 V AC		2 c/o	CC-U/TCR ¹⁾	1SVR040014R2000		0.145 (0.320)
110-240 V AC, 100-300 V DC				1SVR040015R2100		



2CDC 281 012 F0003

CC-U/I

Ordering details - Measuring converters

Supply voltage range	Input signal	Output signal	Type	Order code	Price 1 pc	Weight (1 pc) kg (lb)
24-48 V DC, 24 V AC	refer to table	refer to table	CC-U/ ²⁾	1SVR040006R0100		0.128 (0.282)
110-240 V AC, 100-300 V DC				1SVR040007R0200		0.127 (0.280)
24-48 V DC, 24 V AC			CC-U/ ³⁾	1SVR040008R1300		0.128 (0.282)
110-240 V AC, 100-300 V DC				1SVR040009R1400		

¹⁾ with relay output

²⁾ for current RMS values

³⁾ for voltage RMS values

Analog signal converters - CC-U range

Ordering details - Accessories

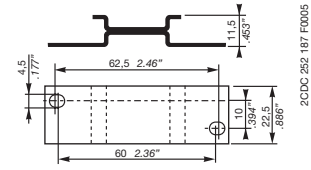

ADP.01

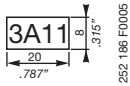

MAR.01

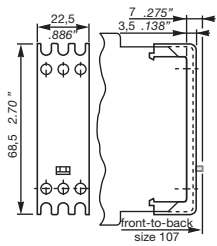

Sealable cover - COV.01

Ordering details - Accessories

For type	Width in mm	Type	Order code	Price	Pkg qty	Weight (1 pc) g (oz)
CC-U	22.5	ADP.01	1SVR430029R0100		1	18.4 (0.65)
CC-U		MAR.01	1SVR366017R0100		10	0.19 (0.007)
CC-U	22.5	COV.01	1SVR430005R0100		1	5.2 (0.18)

Analog signal converters - CC-U range

DIP switch settings

CC-U/STD

Input	Switch 1								Gain	Coarse Type
	1	2	3	4	5	6	7	8		
Potentiometer									0	0
0...50 mV									A...D	C
0...100 mV									4...5	5
0...250 mV									0...1	1
0...500 mV									7...9	8
0...1 V									3...4	3
0...2.5 V									0	0
0...5 V									5...7	6
0...10 V									7...9	8
1...5 V									2...4	3
2...10 V									0	0
-10...+10 V									3...4	3
0...125 mV									3...4	3
0...8 V									B...F	D
-22.5...+22.5 mV									0	0
-11...+11 V									5...7	6
2.5...7.5 V									3...4	4
3.33...9.99 V									2	2
10...0 V									A...D	B
100...0 mV									2...4	3
0...1 mA									4...5	4
0...20 mA									0...1	1
4...20 mA									4...5	4
10...50 mA									4...5	4
20...4 mA									4...2	3
20...0 mA									B...F	D
-0.45...+0.45 mA									4...6	5
-55...+55 mA									-	-
High fail safe *)									-	-
Low fail safe *)									-	-
No fail safe *)									-	-

2CDC 282 019 F0203

*) Detection of input voltage signal interruptions:
If the input signal circuit is interrupted, the output signal changes to the adjusted minimum value (low fail safe) or maximum value (high fail safe).
If "No fail safe" is configured, input signal interruptions are not detected.

Output	Switch 2					
	1	2	3	4	5	6
0...5 V						
0...10 V						
1...5 V						
2...10 V						
-10...+10 V						
-5...+5 V						
-10...0 V						
-5...0 V						
0...6.66 V						
-10...+3.33 V						
-5...+1.66 V						
0...8 V						
0...4 V						
-10...-2 V						
-5...-1 V						
1.25...6.25 V						
-7.5...+2.5 V						
-3.75...+1.25 V						
1.66...8.33 V						
-6.66...+6.66 V						
-3.33...+3.33 V						
-8...0 V						
-4...0 V						
0...1 mA						
0...20 mA						
4...20 mA						
0...10 mA						
0...0.5 mA						
0...13.33 mA						
0...666 µA						
0...16 mA						
0...800 µA						
0...8 mA						
0...400 µA						
2.5...12.5 mA						
125...625 µA						
3.33...16.66 mA						
166...833 µA						
0.2...1 mA						
2...10 mA						
100...500 µA						

2CDC 282 020 F0203

Legend	
■	ON
□	OFF
□	no influence

2CDC 282 003 F0204

CC-U/STDR with relay output

Input	Switch					
	1	2	3	4	5	6
0...10 V						
0...5 V						
0...1 V						
-10...+10 V						
1...5 V						
0...20 mA						
4...20 mA						
Output						
Closed-circuit principle						
Open-circuit principle						

2CDC 282 005 F0204

Legend	
■	ON
□	OFF
□	no influence

2CDC 282 003 F0204

CC-U/RTD

Type	Input Range	Switch 1						Switch 2						Gain Coarse	
		1	2	3	4	5	6	1	2	3	4	5	6		
PT10	0...500 °C														F
	0...550 °C														E
	0...600 °C														D
	0...650 °C														C
	0...700 °C														B
	0...750 °C														A
	0...800 °C														9
PT100	0...850 °C														8
	0...50 °C														F
	0...60 °C														E
	0...70 °C														B
	0...80 °C														A
	0...90 °C														9
	0...100 °C														8
PT1000	0...200 °C														3
	0...300 °C														2
	0...400 °C														1
	0...500 °C														0
	0...10 °C														8
	0...20 °C														3
	0...30 °C														2
Low fail safe *)	0...40 °C														1
	0...50 °C														0
	0...60 °C														0
High fail safe *)															-

2CDC 282 023 F0203

Output	Switch 3					
	1	2	3	4	5	6
0...5 V						
0...10 V						
1...5 V						
2...10 V						
-10...+10 V						
-5...+5 V						
-10...0 V						
-5...0 V						
0...6.66 V						
-10...+3.33 V						
-5...+1.66 V						
0...8 V						
0...4 V						
-10...-2 V						
-5...-1 V						
1.25...6.25 V						
-7.5...+2.5 V						
-3.75...+1.25 V						
1.66...8.33 V						
-6.66...+6.66 V						
-3.33...+3.33 V						
-8...0 V						
-4...0 V						
0...1 mA						
0...20 mA						
4...20 mA						
0...10 mA						
0...0.5 mA						
0...13.33 mA						
0...666 µA						
0...16 mA						
0...800 µA						
0...8 mA						
0...400 µA						
2.5...12.5 mA						
125...625 µA						
3.33...16.66 mA						
166...833 µA						
0.2...1 mA						
2...10 mA						
100...500 µA						

2CDC 282 024 F0203

Legend	
■	ON
□	OFF
□	no influence

2CDC 282 003 F0204

Analog signal converters - CC-U range

DIP switch settings

CC-U/V

Output	Switch					
	1	2	3	4	5	6
0...5 V						
0...10 V						
1...5 V						
2...10 V						
-10...+10 V						
-5...+5 V						
-10...0 V						
-5...0 V						
0...6.66 V						
-10...+3.33 V						
-5...+1.66 V						
0...8 V						
0...4 V						
-10...-2 V						
-5...-1 V						
1.25...6.25 V						
-7.5...+2.5 V						
-3.75...+1.25 V						
1.66...8.33 V						
-6.66...+6.66 V						
-3.33...+3.33 V						
-8...0 V						
-4...0 V						
0...1 mA						
0...20 mA						
4...20 mA						
0...10 mA						
0...0.5 mA						
0...13.33 mA						
0...666 µA						
0...16 mA						
0...800 µA						
0...8 mA						
0...400 µA						
2.5...12.5 mA						
125...625 µA						
3.33...16.66 mA						
166...833 µA						
0.2...1 mA						
2...10 mA						
100...500 µA						

2CDC 282 003 F0204 2CDC 282 029 F0203

Legend	
■	ON
□	OFF
□	no influence

CC-U/TC

Output	Switch 3					
	1	2	3	4	5	6
0...5 V						
0...10 V						
1...5 V						
2...10 V						
-10...+10 V						
-5...+5 V						
-10...0 V						
-5...0 V						
0...6.66 V						
-10...+3.33 V						
-5...+1.66 V						
0...8 V						
0...4 V						
-10...-2 V						
-5...-1 V						
1.25...6.25 V						
-7.5...+2.5 V						
-3.75...+1.25 V						
1.66...8.33 V						
-6.66...+6.66 V						
-3.33...+3.33 V						
-8...0 V						
-4...0 V						
0...1 mA						
0...20 mA						
4...20 mA						
0...10 mA						
0...0.5 mA						
0...13.33 mA						
0...666 µA						
0...16 mA						
0...800 µA						
0...8 mA						
0...400 µA						
2.5...12.5 mA						
125...625 µA						
3.33...16.66 mA						
166...833 µA						
0.2...1 mA						
2...10 mA						
100...500 µA						

2CDC 282 017 F0208

Legend	
■	ON
□	OFF
□	no influence

Type	Input Range	Switch 1						Switch 2							
		1	2	3	4	5	6	1	2	3	4	5	6		
K	0-100...900 °C														
J	0-250...1350 °C														
J	0-100...750 °C														
T	0-100...400 °C														
T	-150-0...400 °C														
S	0-250...1550 °C														
E	0-100...700 °C														
E	0-200...1000 °C														
N	0-100...650 °C														
N	0-200...1300 °C														
R	0-250...1350 °C														
R	0-450...1700 °C														
B	0-700...1750 °C														
mV	0-2...10 mV														
	0-10...50 mV														
	Low fail safe *)														
	High fail safe *)														

2CDC 282 010 F0204

*) Detection of input signal interruptions:
If the input signal circuit is interrupted, the output signal changes to the adjusted minimum value (low fail safe) or maximum value (high fail safe).

CC-U/I

Output	Switch					
	1	2	3	4	5	6
0...5 V						
0...10 V						
1...5 V						
2...10 V						
-10...+10 V						
-5...+5 V						
-10...0 V						
-5...0 V						
0...6.66 V						
-10...+3.33 V						
-5...+1.66 V						
0...8 V						
0...4 V						
-10...-2 V						
-5...-1 V						
1.25...6.25 V						
-7.5...+2.5 V						
-3.75...+1.25 V						
1.66...8.33 V						
-6.66...+6.66 V						
-3.33...+3.33 V						
-8...0 V						
-4...0 V						
0...1 mA						
0...20 mA						
4...20 mA						
0...10 mA						
0...0.5 mA						
0...13.33 mA						
0...666 µA						
0...16 mA						
0...800 µA						
0...8 mA						
0...400 µA						
2.5...12.5 mA						
125...625 µA						
3.33...16.66 mA						
166...833 µA						
0.2...1 mA						
2...10 mA						
100...500 µA						

2CDC 282 003 F0204 2CDC 282 029 F0203

Legend	
■	ON
□	OFF
□	no influence

CC-U/TCR with relay output

Type	Input Range	Switch					
		1	2	3	4	5	6
J	0...240 °C						
J	0...480 °C						
K	0...1200 °C						
K	0...250 °C						
K	0...500 °C						
T	0...1350 °C						
T	-150...+120 °C						
S	0...220 °C						
S	0...400 °C						
S	0...210 °C						
S	0...380 °C						
S	0...860 °C						
S	0...1550 °C						
Output							
Closed-circuit principle							
Open-circuit principle							

2CDC 282 004 F0204

Legend	
■	ON
□	OFF
□	no influence

Analog signal converters - CC-U range

Wiring instructions

CC-U/STD

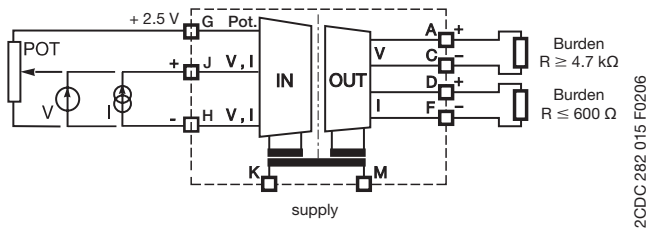

CC-U/STDR with relay output

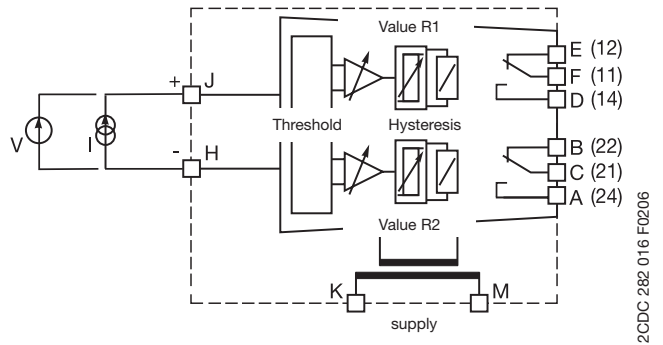

4

CC-U/RTD

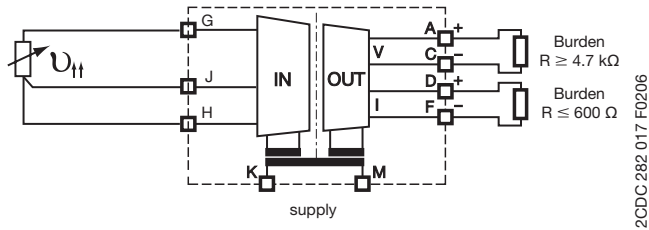

CC-U/V

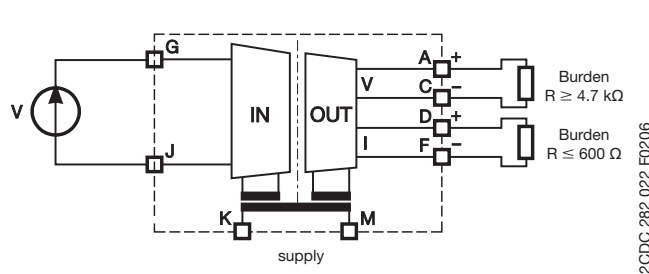

CC-U/I

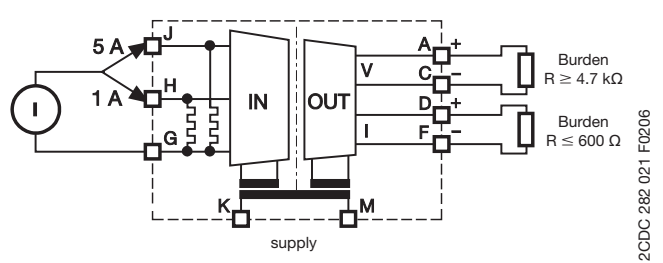

CC-U/TC

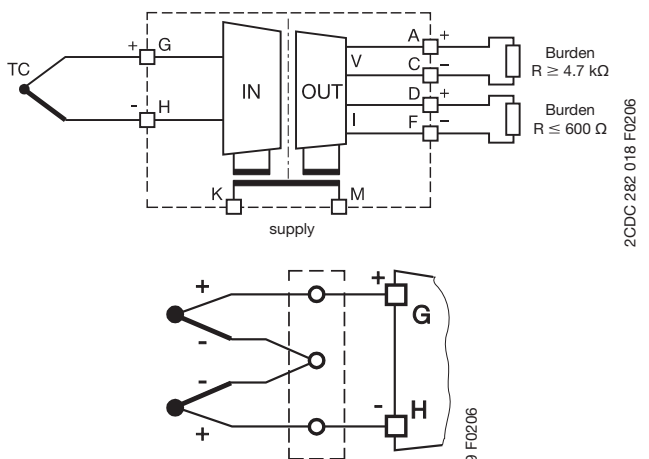

CC-U/TCR with relay output

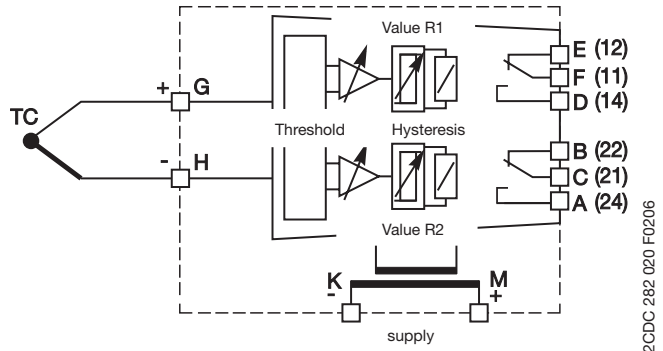

without cold-junction compensation:
switch SW2.2 = OFF

Analog signal converters - CC-U range

Technical information

CC-U/STD

Adjustment range

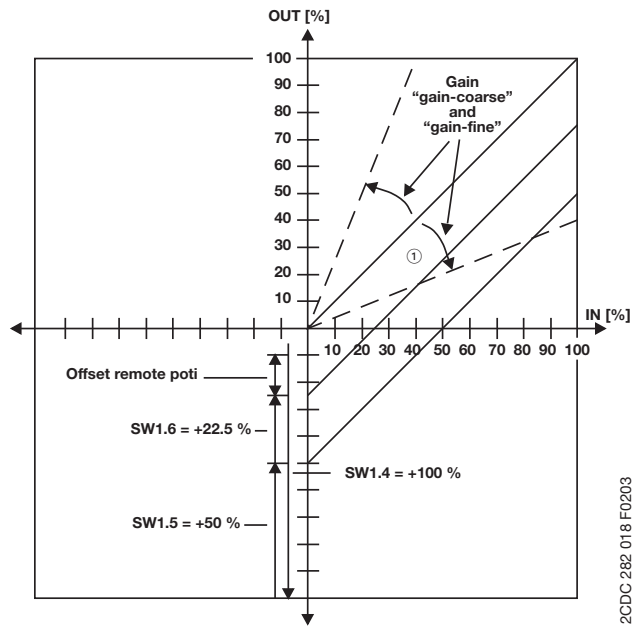

CC-U/STDR with relay output

Function diagrams

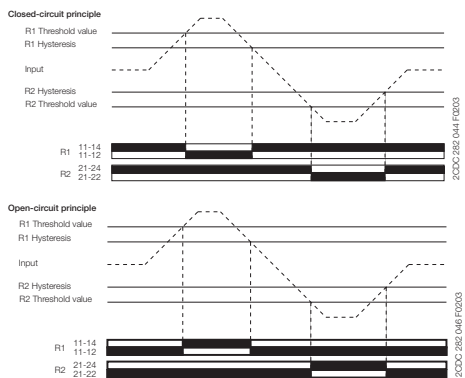

Switching points

Switching points of the output relay depending on the input range, configuration open-circuit principle

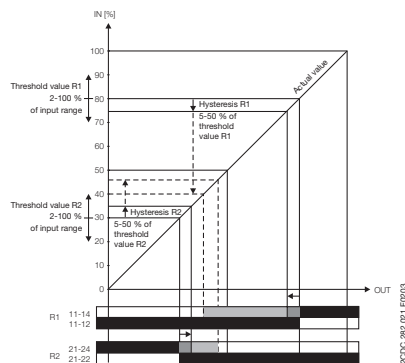

Analog signal converters - CC-U range

Technical information

CC-U/RTD

Characteristic curves

Resistance of PT10, PT100 and PT1000 sensors depending on the temperature

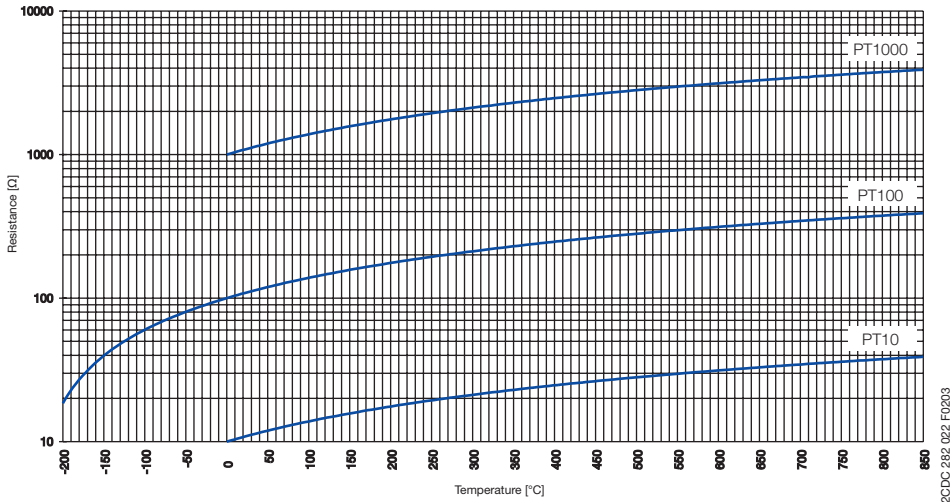

4

CC-U/V

Input range selection

Selecting input range by front-face rotary switch	Switch position
0...100 V	1
0...150 V	2
0...250 V	3
0...300 V	4
0...400 V	5
0...450 V	6
0...550 V	7
0...600 V	8

2CDC 282 012 F0204

Example of application

RMS measurement and conversion of a phase-angle controlled voltage signal $L1 = 230\text{ V}$

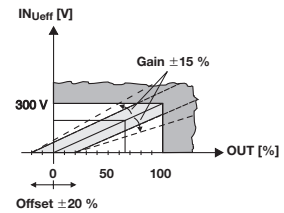
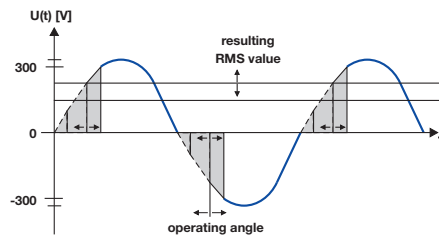

2CDC 282 030 F0203

Analog signal converters - CC-U range

Technical information

CC-U/I

Input range selection

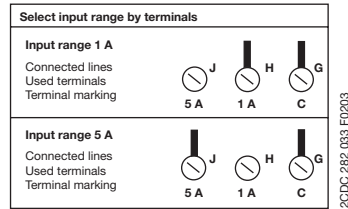

Example of application

RMS measurement and conversion of a current signal

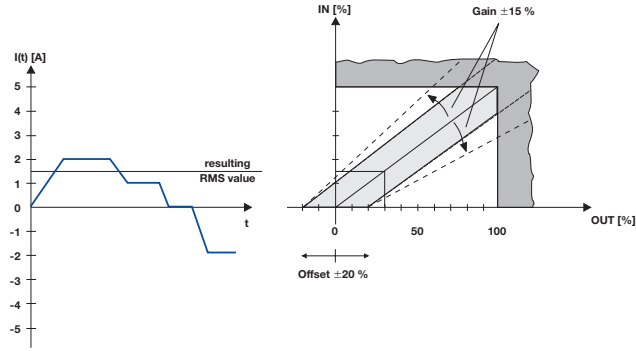

CC-U/TC

Characteristic curve

Thermocouple voltages depending on the temperature

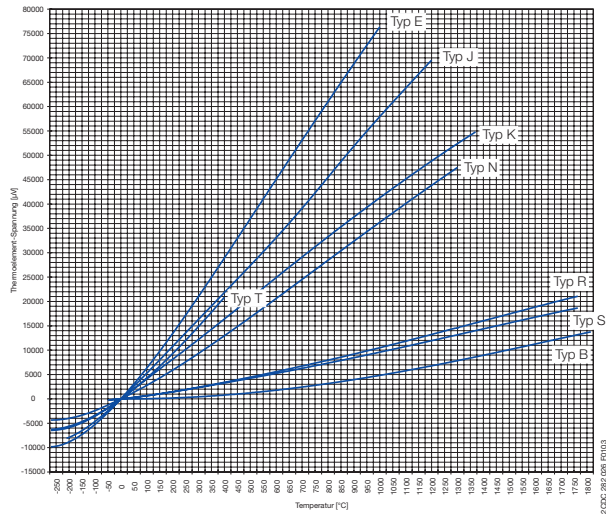

CC-U/TCR with relay output

Function diagrams

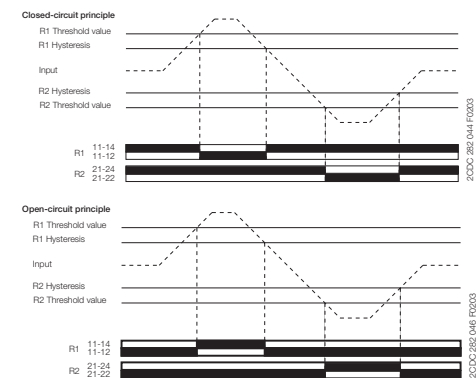

Switching points

Switching points of the output relay depending on the input range, configuration open-circuit principle

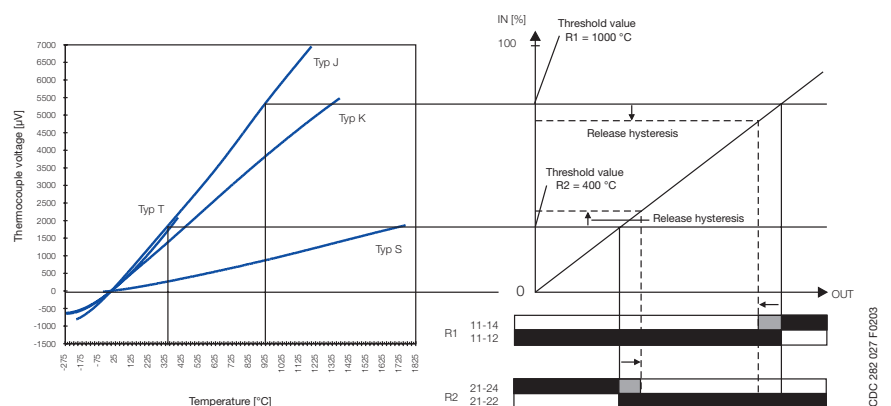

Analog signal converters - CC-U range

Technical data

4

Type	CC-U/STD			CC-U/RTD	CC-U/TC	
Input circuits - Analog inputs	J-G-H	Current	Voltage	Potentiometer	Temperature sensors (IEC/EN 60751)	Thermocouples (IEC/EN 60584-1)
Input signal		0-20 mA 4-20 mA 10-50 mA 0-1 mA	0-100 mV, 0-1 V, 0-5 V, 1-5 V, 0-10 V, 2-10 V, ± 10 V	470 Ω -1 MΩ ¹⁾	PT10, PT100, PT1000 ²⁾	TC.K TC.J TC.T TC.S TC.E TC.N TC.R TC.B
Limitation of input signals		± 55 mA	± 11 V	-	-	-
Rated input range		-	-	-	max. temperature adjustable: 6-60 °C for PT1000 50-500 °C for PT100 500-850 °C for PT10	refer to temperature specs. of individual thermocouples
Influence of line resistance		-	-	-	0.015 °C/Ω	< 0.01 % / 100 Ω
Gain adjustment range (universal devices)		0.9-110 mA	45 mV - 22 V	-	see DIP switch settings	-
Offset adjustment range (universal devices)		-137.5...+62.5 %			± 5 %	± 10 %
Input impedance		for different ranges			-	-
without detection of input signal interruption		51 Ω	6 MΩ	3 GΩ	-	-
with detection of input signal interruption		51 Ω	3.5 MΩ	9.5 GΩ	-	-
Suppression at 50 Hz		-	-	-	-	> 40 dB
Common-mode rejection		-	-	-	120 dB	105 dB
Output circuits - Analog outputs	D-F, A-C	Current			Voltage	
Output signal		0-20 mA, 4-20 mA			0-5 V, 1-5 V, 0-10 V, 2-10 V, ± 10 V	
Output burden		≤ 600 Ω			≥ 4.7 KΩ	
Accuracy ³⁾		±0.1 % of full-scale			±0.2 % of full-scale	±0.1 % of full-scale
Residual ripple					< 0.15 %	-
Response time		200 μs			10 ms	200 ms
Transmission frequency		1 kHz			80 Hz	2 Hz (to -3 dB)
Supply circuits	K-M	DC versions			AC versions	
Rated supply voltage		24-48 V DC			110-240 V AC	
Supply voltage range		24-48 V DC / 24 V AC			110-240 V AC / 100-300 V DC	
Supply voltage tolerance		DC: -15...+15 %			AC: -15...+10 %	
Rated frequency		0 Hz or 50/60 Hz				
Power consumption		2 W at 24 V DC			4.5 VA at 230 V AC	
Indication of operational states		U: green LED				
General data		operation / storage				
Ambient temperature range		-20...+60 °C / -40...+80 °C				
Temperature coefficient		±150 ppm/°C			±250 ppm/°C	±200 ppm/°C at min. offset; ±400 ppm/°C at max. offset
Mounting position		any				
Mounting		DIN rail (IEC/EN 60715), snap-on mounting / screw mounting with adapter				
Electrical connection		fine-strand with(out) wire end ferrule or rigid				
Connecting capacity		plug-connector with screw terminals 0.2-2.5 mm ² (24-12 AWG)				
Stripping length		7 mm (0.28 inch)				
Tightening torque		0.4 Nm (3.5 lb.in)				
Isolation data						
Isolation test (between all isolated circuits)		1.5 kV				
Test voltage (between all isolated circuits)		1.5 kV / 50 Hz				
Standards / Directives						
Standards		EN 50178				
Low Voltage Directive		2014/35/EU				
EMC Directive		2014/30/EU				
RoHS Directive		2011/65/EU				
Electromagnetic compatibility						
Interference immunity to electrostatic discharge	IEC/EN 61000-4-2	IEC/EN 61000-6-2 level 3 (±6 kV / ±8 kV)				
radiated, radio-frequency, electromagnetic field	IEC/EN 61000-4-3	10 V/m				
electrical fast transient / burst surge	IEC/EN 61000-4-4	level 3 (±2 kV / 5 kH)				
conducted disturbances, induced by radio-frequency fields	IEC/EN 61000-4-5	±2 kV / ±1 kV				
Interference emission	IEC/EN 61000-4-6	10 V				
high-frequency radiated	IEC/CISPR 11, EN 55011	IEC/EN 61000-6-4 class B				
high-frequency conducted	IEC/CISPR 11, EN 55011	class B				

¹⁾ Detection of an input signal break (fail safe) and resistance > 10 kΩ results in a linearity of ±0.2 %.

²⁾ When connecting a 2-wire sensor, the terminals J and H have to be jumpered.

³⁾ Includes non-linearity and factory setting, influenced by supply voltage and output load.

Analog signal converters - CC-U range

Technical data

Type	CC-U/STDR		CC-U/TCR
Input circuits - Analog inputs	J-H	Current	Voltage
Measuring signal / input range		0-20 mA 4-20 mA	0-1 V / 1-5 V 0-10 / ±10 V
Input resistance		approx. 50 Ω	approx. 1.5 MΩ
Adjustable threshold		2-100 % of selected input range	
Adjustable hysteresis		5-50 % of threshold	
Repeat accuracy (constant parameters)		±0.5 % of full-scale	
Output circuits - Relay outputs	E-D-F, B-C-A	Relay, 2 c/o contacts	
Rated switching voltage		250 V AC	
Rated switching current	AC-12 (resistive) 230 V	4 A	
	AC-15 (inductive) 230 V	3 A	
	DC-12 (resistive) 24 V	4 A	
	DC-13 (inductive) 24 V	2 A	
AC rating (UL 508)	utilization category (Control Circuit Rating Code)	B 300	
	max. rated operational voltage	300 V AC	
	max. continuous thermal current at B 300	5 A	
	max. making/breaking apparent power at B 300	3600/360 VA	
Minimum switching voltage		12 V	
Minimum switching current / power		10 mA / 0.6 VA (W)	
Response time		10 ms	
Mechanical lifetime		30 x 10 ⁶ switching cycles	
Electrical lifetime	at AC-12, 230 V, 4 A	0.1 Mio. switching cycles	
Supply circuits	K-M	DC versions	AC versions
Rated supply voltage		24-48 V DC	110-240 V AC
Supply voltage range		24-48 V DC / 24 V AC	110-240 V AC / 100-300 V DC
Supply voltage tolerance		DC: -15...+15 %	AC: -15...+10 %
Rated frequency		0 Hz or 50/60 Hz	
Power consumption		2 W at 24 V DC	4.5 VA at 230 V AC
Indication of operational states			
Supply voltage		U: green LED	
1st / 2nd output relay energized		R1: yellow LED / R2: yellow LED	
General data			
Ambient temperature range	operation / storage	-20...+60 °C / -40...+80 °C	
Temperature coefficient		±300 ppm/°C	
Mounting position		any	
Mounting		DIN rail (IEC/EN 60715), snap-on mounting / screw mounting with adapter	
Electrical connection			
Connecting capacity	rigid	plug-connector with screw terminals 0.2-2.5 mm ² (24-12 AWG)	
	fine-strand with(out) wire end ferrule	plug-connector with screw terminals 0.2-2.5 mm ² (24-12 AWG)	
Stripping length		7 mm (0.28 inch)	
Tightening torque		0.4 Nm (3.5 lb.in)	
Isolation data			
Insulation voltage (between all isolated circuits)		2.5 kV	
Test voltage (between all isolated circuits)		2.5 kV	
Standards / Directives			
Standards		IEC/EN 60947-5-1, EN 50178	
Low Voltage Directive		2014/35/EU	
EMC Directive		2014/30/EU	
RoHS Directive		2011/65/EU	
Electromagnetic compatibility			
Interference immunity to		IEC/EN 61000-6-2	
electrostatic discharge	IEC/EN 61000-4-2	level 3 (±6 kV / ±8 kV)	
radiated, radio-frequency, electromagnetic field	IEC/EN 61000-4-3	10 V/m	
electrical fast transient / burst	IEC/EN 61000-4-4	level 3 (±2 kV / 5 kHz)	
surge	IEC/EN 61000-4-5	±2 kV / ±1 kV	
conducted disturbances, induced by radio-frequency fields	IEC/EN 61000-4-6	10 V	
Interference emission		IEC/EN 61000-6-4	
high-frequency radiated	IEC/CISPR 11, EN 55011	class B	
high-frequency conducted	IEC/CISPR 11, EN 55011	class B	

Analog signal converters - CC-U range

Technical data

Type		CC-U/I	CC-U/V
Input circuits - Analog inputs	J-G-H	any current signals, RMS measurement	any voltage signals, RMS measurement
Rated input range		0-1 A 0-5 A	0-100 V, 0-150V, 0-250 V 0-300 V, 0-400 V, 0-450 V 0-550 V, 0-600 V
Measuring frequency		0-600 Hz	
Overload capacity of inputs	input range 1	$10 \times I_{Nom}$ (10 A) for max. 2 s	-
	input range 2	$10 \times I_{Nom}$ (50 A) for max. 2 s	-
Gain adjustment range		±15 %	
Offset adjustment range		±20 %	
Input impedance / resistance		1A: 60 mΩ, 5 A: 12 mΩ	> 800 kΩ
Output circuits - Analog outputs	D-F, A-C	Current	Voltage
Output signal		0-20 mA, 4-20 mA	0-5 V, 1-5 V, 0-10 V, 2-10 V, ± 10 V
Output load		≤ 600 Ω	≥ 4.7 kΩ
Accuracy ¹⁾		±0.5 % of full-scale	
Temperature coefficient		±250 ppm/°C max.	±300 ppm/°C max.
Residual ripple		< 0.15 %	
Response time		150 ms	
Supply circuits	K-M	DC versions	AC versions
Rated supply voltage		24-48 V DC	110-240 V AC
Supply voltage range		24-48 V DC, 24 V AC	110-240 V AC, 100-300 V DC
Supply voltage tolerance		DC: -15...+15 %	AC: -15...+10 %
Rated frequency		0 Hz or 50/60 Hz	
Power consumption		2 W at 24 V DC	4.5 VA at 230 V AC
Indication of operational states			
Supply voltage		U: green LED	
General data			
Ambient temperature range	operation / storage	-20...+60 °C / -40...+80 °C	
Mounting position		any	
Mounting		DIN rail (IEC/EN 60715), snap-on mounting / screw mounting with adapter	
Electrical connection			
Connecting capacity	rigid	plug-connector with screw terminals 0.2-2.5 mm ² (24-12 AWG)	
	fine-strand with(out) wire end ferrule	plug-connector with screw terminals 0.2-2.5 mm ² (24-12 AWG)	
Stripping length		7 mm (0.28 inch)	
Tightening torque		0.4 Nm (3.5 lb.in)	
Isolation data			
Insulation voltage (between all isolated circuits)		1.5 kV	
Test voltage (between all isolated circuits)		1.5 kV / 50 Hz	
Standards / Directives			
Standards		EN 50178	
Low Voltage Directive		2014/35/EU	
EMC Directive		2014/30/EU	
RoHS Directive		2011/65/EU	
Electromagnetic compatibility			
Interference immunity to		IEC/EN 61000-6-2	
electrostatic discharge	IEC/EN 61000-4-2	level 3 (±6 kV / ±8 kV)	
radiated, radio-frequency, electromagnetic field	IEC/EN 61000-4-3	10 V/m	
electrical fast transient / burst	IEC/EN 61000-4-4	level 3 (±2 kV / 5 kHz)	
surge	IEC/EN 61000-4-5	±2 kV / ±1 kV	
conducted disturbances, induced by radio-frequency fields	IEC/EN 61000-4-6	10 V	
Interference emission		IEC/EN 61000-6-4	
high-frequency radiated	IEC/CISPR 11, EN 55011	class B	
high-frequency conducted	IEC/CISPR 11, EN 55011	class B	

¹⁾ Includes non-linearity and factory setting, influenced by supply voltage and output load.

Analog signal converters - CC-U range

Technical diagr., Connection diagr., Dimensional drawings

Technical diagrams

Load limit curves CC-U/xxR

Resistive AC load

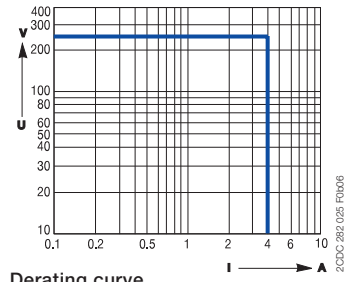

Resistive DC load

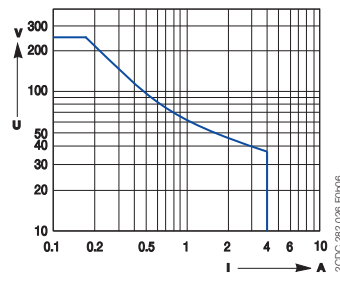

Derating curve

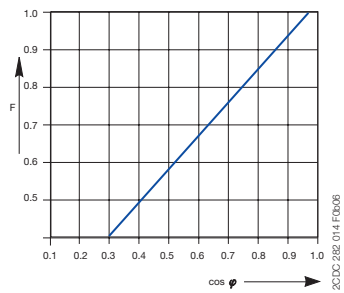

Connection diagram CC-U/x

Width 22.5 mm (0.89 in)

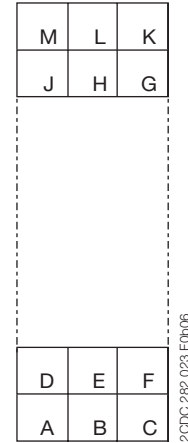

Dimensional drawings Dimensions in mm and inches

CC-U/x , CC-U/xR

