

V_{RRM}	=	5500 V
$I_{F(AV)M}$	=	175 A
I_{FSM}	=	3×10^3 A
$V_{(T0)}$	=	3.35 V
r_T	=	7.2 mW
$V_{DC-link}$	=	3300 V

Fast Recovery Diode

5SDF 02D6004

PRELIMINARY

Doc. No. 5SYA1118-02 Okt. 02

- Patented free-floating technology
- Industry standard housing
- Cosmic radiation withstand rating
- Low on-state and switching losses
- Optimized for snubberless operation

Blocking

Maximum rated values ¹⁾

Parameter	Symbol	Conditions	Value	Unit
Repetitive peak reverse voltage	V_{RRM}	$f = 50$ Hz, $t_p = 10$ ms, $T_{vj} = 115^\circ\text{C}$	5500	V
Permanent DC voltage for 100 FIT failure rate	$V_{DC-link}$	Ambient cosmic radiation at sea level in open air. (100% Duty)	3300	V
Permanent DC voltage for 100 FIT failure rate	$V_{DC-link}$	Ambient cosmic radiation at sea level in open air. (5% Duty)	3900	V

Characteristic values

Parameter	Symbol	Conditions	min	typ	max	Unit
Repetitive peak reverse current	I_{RRM}	$V_R = V_{RRM}$, $T_{vj} = 115^\circ\text{C}$			20	mA

Mechanical data

Maximum rated values ¹⁾

Parameter	Symbol	Conditions	min	typ	max	Unit
Mounting force	F_m		14	16	18	kN
Acceleration	a	Device unclamped			50	m/s^2
Acceleration	a	Device clamped			200	m/s^2

Characteristic values

Parameter	Symbol	Conditions	min	typ	max	Unit
Weight	m				0.25	kg
Housing thickness	H		26.0		26.6	mm
Surface creepage distance	D_s		30			mm
Air strike distance	D_a		20			mm

Note 1 Maximum rated values indicate limits beyond which damage to the device may occur

ABB Switzerland Ltd, Semiconductors reserves the right to change specifications without notice.



On-state

Maximum rated values ¹⁾

Parameter	Symbol	Conditions	min	typ	max	Unit
Max. average on-state current	$I_{F(AV)M}$	Half sine wave, $T_C = 70\text{ °C}$			175	A
Max. RMS on-state current	$I_{F(RMS)}$				275	A
Max. peak non-repetitive surge current	I_{FSM}	$t_p = 10\text{ ms}$, $T_{vj} = 115\text{ °C}$, $V_R = 0\text{ V}$			3×10^3	A
Limiting load integral	I^2t				45×10^3	A ² s
Max. peak non-repetitive surge current	I_{FSM}	$t_p = 1\text{ ms}$, $T_{vj} = 115\text{ °C}$, $V_R = 0\text{ V}$			8×10^3	A
Limiting load integral	I^2t				32×10^3	A ² s

Characteristic values

Parameter	Symbol	Conditions	min	typ	max	Unit
On-state voltage	V_F	$I_F = 520\text{ A}$, $T_{vj} = 115\text{ °C}$			7.1	V
Threshold voltage	$V_{(T0)}$	$T_{vj} = 115\text{ °C}$			3.35	V
Slope resistance	r_T	$I_F = 200 \dots 1000\text{ A}$			7.2	mΩ

Turn-on

Characteristic values

Parameter	Symbol	Conditions	min	typ	max	Unit
Peak forward recovery voltage	V_{FRM}	$di/dt = 1000\text{ A}/\mu\text{s}$, $T_{vj} = 115\text{ °C}$			370	V

Turn-off

Maximum rated values ¹⁾

Parameter	Symbol	Conditions	min	typ	max	Unit
Max. decay rate of on-state current	di/dt_{crit}	$I_{FM} = A$, $T_{vj} = 115\text{ °C}$ $V_{DC-link} = 3300\text{ V}$			220	A/μs

Characteristic values

Parameter	Symbol	Conditions	min	typ	max	Unit
Reverse recovery current	I_{RM}	$I_{FQ} = 520\text{ A}$, $V_{DC-Link} = 3300\text{ V}$			300	A
Reverse recovery charge	Q_{rr}	$di/dt = 220\text{ A}/\mu\text{s}$, $L_{CL} = \text{nH}$				μC
Turn-off energy	E_{rr}	$C_{CL} = \mu\text{F}$, $R_{CL} = \Omega$, $T_j = 115\text{ °C}$			1.8	J

Thermal

Maximum rated values ¹⁾

Parameter	Symbol	Conditions	min	typ	max	Unit
Operating junction temperature range	T_{vj}		-40		115	°C
Storage temperature range	T_{stg}		-40		125	°C

Characteristic values

Parameter	Symbol	Conditions	min	typ	max	Unit
Thermal resistance junction to case	$R_{th(j-c)}$	Double-side cooled $F_m = 14...18$ kN			40	K/kW
	$R_{th(j-c)A}$	Anode-side cooled $F_m = 14...18$ kN			80	K/kW
	$R_{th(j-c)C}$	Cathode-side cooled $F_m = 14...18$ kN			80	K/kW
Thermal resistance case to heatsink	$R_{th(c-h)}$	Double-side cooled $F_m = 14...18$ kN			8	K/kW
	$R_{th(c-h)}$	Single-side cooled $F_m = 14...18$ kN			16	K/kW

Analytical function for transient thermal impedance:

$$Z_{th(j-c)}(t) = \sum_{i=1}^n R_{th i} (1 - e^{-t/t_i})$$

i	1	2	3	4
$R_{th i}$ (K/kW)	25.699	9.472	3.381	1.466
τ_i (s)	0.3802	0.0483	0.0060	0.0018

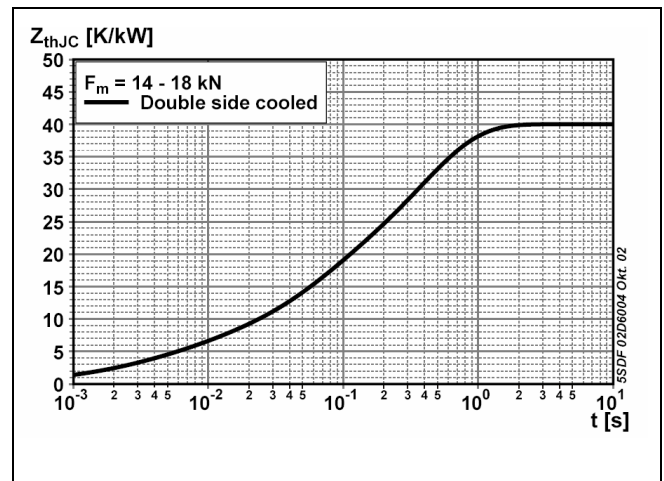

Fig. 1 Transient thermal impedance (junction to case) vs. time in analytical and graphical form (max. values)

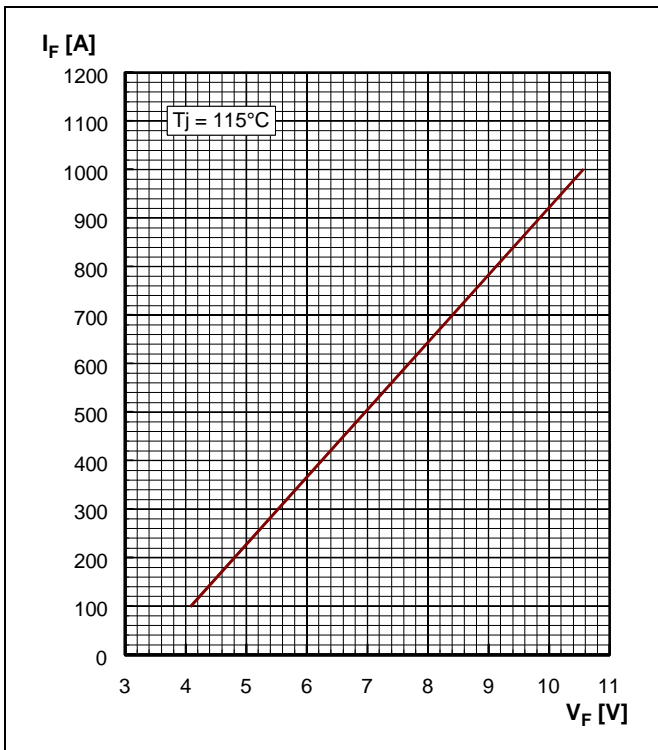

Fig. 2 Forward current vs. forward voltage

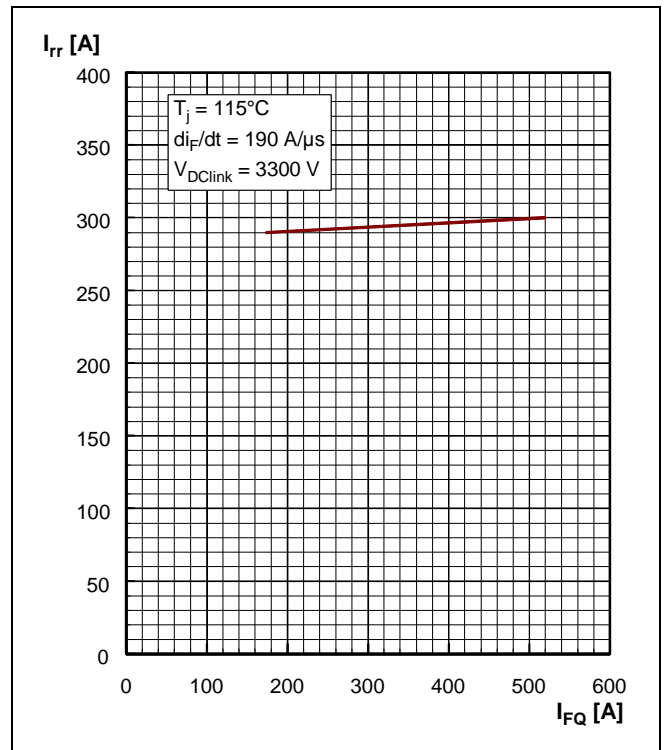

Fig. 3 Diode reverse recovery current vs. turn-off current

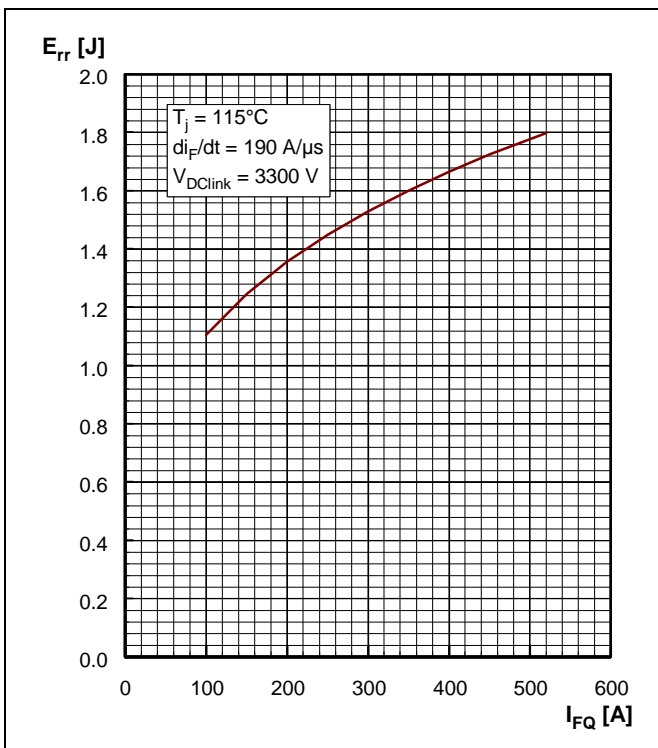

Fig. 4 Diode turn-off energy per pulse vs. turn-off current

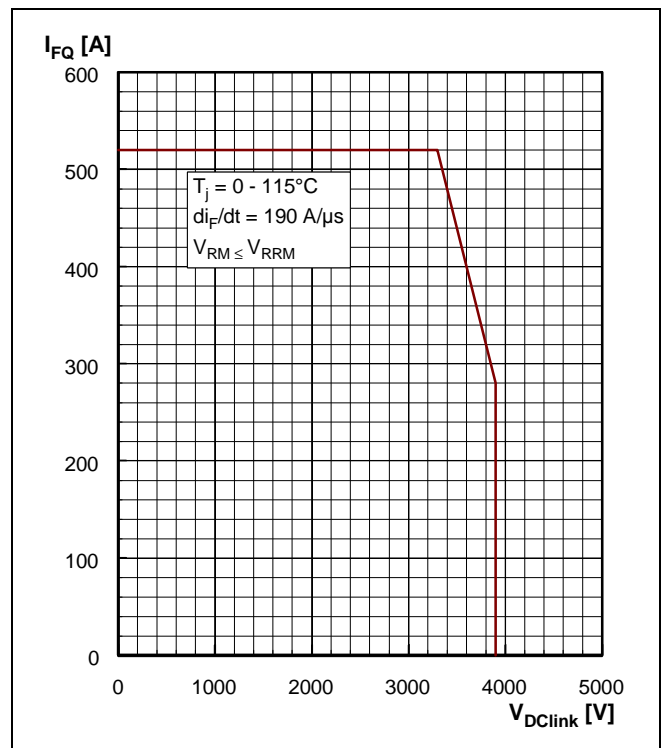

Fig. 5 Max. repetitive diode forward current

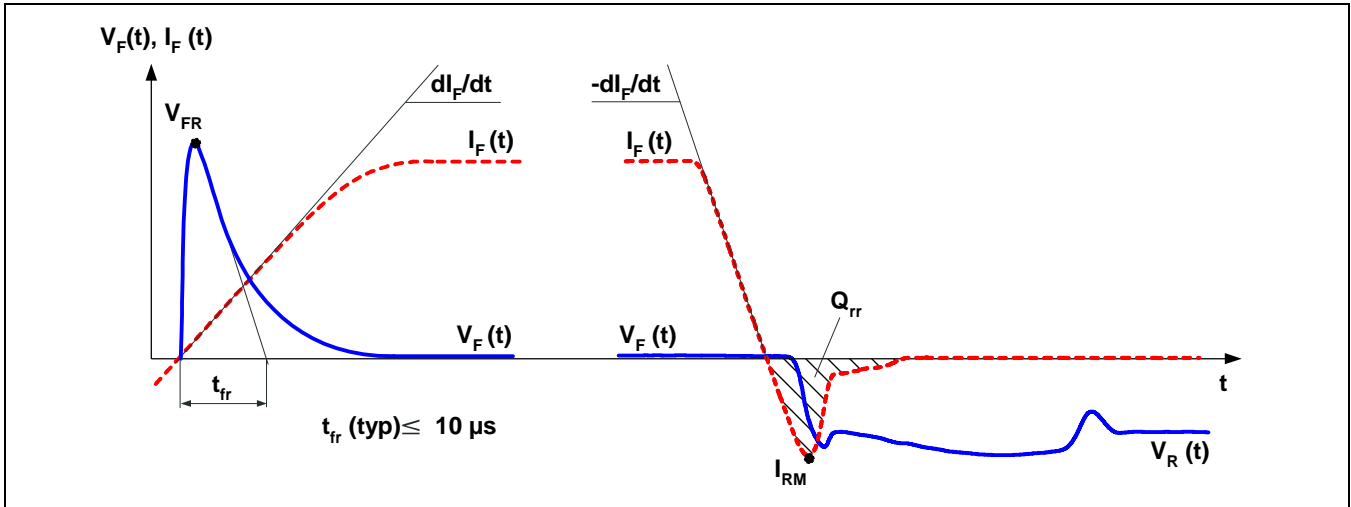

Fig. 6 General current and voltage waveforms

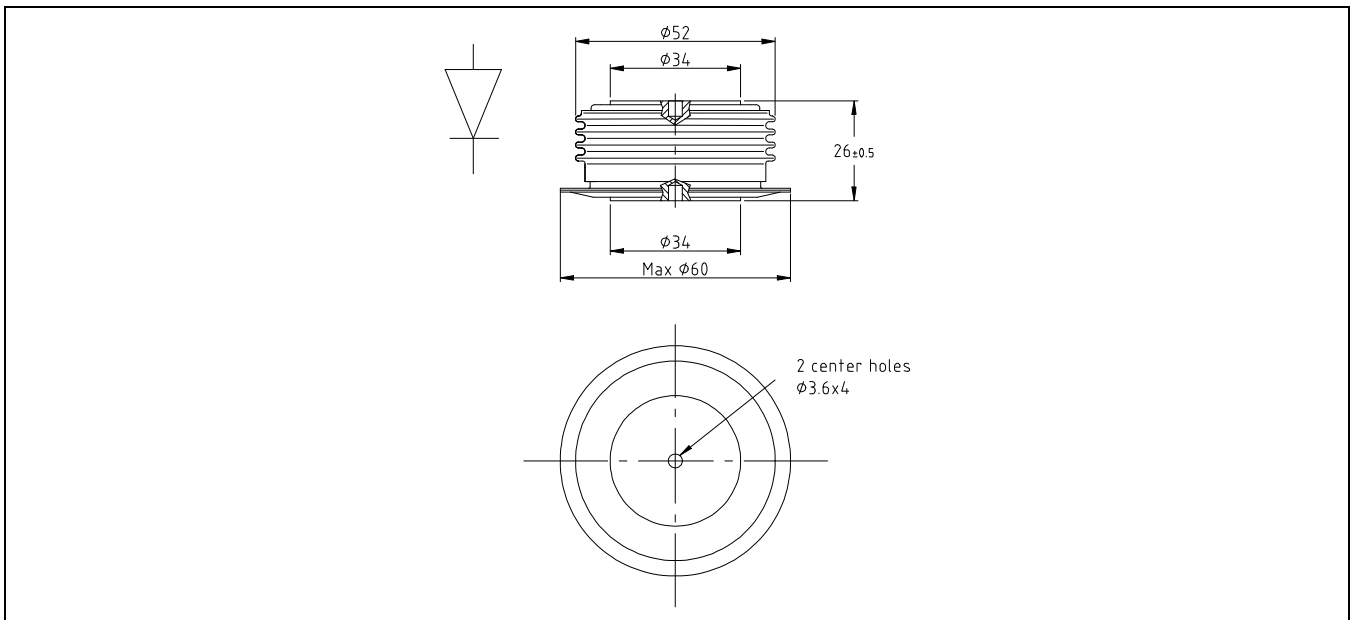

Fig. 7 Outline drawing; all dimensions are in millimeters and represent nominal values unless stated otherwise

Related documents:

Doc. Nr	Titel
5SYA 2036	Recommendations regarding mechanical clamping of Press Pack High Power Semiconductors
5SZK 9104	Specification of environmental class for pressure contact diodes, PCTs and GTO, STORAGE available on request, please contact factory
5SZK 9105	Specification of environmental class for pressure contact diodes, PCTs and GTO, TRANSPORTATION available on request, please contact factory

Please refer to <http://www.abb.com/semiconductors> for current version of documents.

ABB Switzerland Ltd, Semiconductors reserves the right to change specifications without notice.

ABB

ABB Switzerland Ltd
Semiconductors
 Fabrikstrasse 3
 CH-5600 Lenzburg, Switzerland

Doc. No. 5SYA1118-02 Okt. 02

Telephone +41 (0)58 586 1419
 Fax +41 (0)58 586 1306
 Email abbsem@ch.abb.com
 Internet www.abb.com/semiconductors