

DATASHEET

CurrentGuard™ Plus series — CGP3-080

Current Technology™ surge protective devices



Product features

- UL Listed 1449 4th edition for Type 1 and Type 2 SPD applications
- Thermally protected MOVs provide superior protection and continuous operation
- 200 kAIC short circuit current rating allows direct bus connection without the need for an upstream over-current protection device
- Advanced monitoring is standard with surge counter, tri-color LEDs, dry relay contacts, audible alarm, alarm silence button and fault light
- UL 1283 EMI/RF filter available as an option
- DTS-2 compatible for proactive testing
- Compact and lightweight design
- 15-year standard warranty

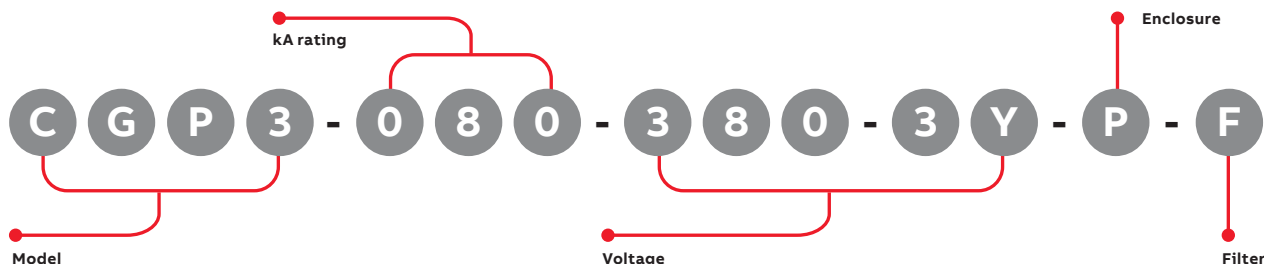

Model number scheme

kA rating	Suffix
80 kA per mode, 160 kA per phase	080

Voltage (must choose one)	Suffix
120 V, 1-phase, 2-wire + ground	120-1G
127 V, 1-phase, 2-wire + ground	127-1G
220 V, 1-phase, 2-wire + ground	220-1G
230 V, 1-phase, 2-wire + ground	230-1G
240 V, 1-phase, 2-wire + ground	240-1G
277 V, 1-phase, 2-wire + ground	277-1G
347 V, 1-phase, 2-wire + ground	347-1G
480 V, 1-phase, 2-wire + ground	480-1G
240/120 V, 2-phase, 3-wire + ground	240-2G
480/240 V, 2-phase, 3-wire + ground	480-2G
600/347 V, 2-phase, 3-wire + ground	600-2G
240Δ /120 V, 3-phase high-leg, 4-wire + ground	240-3H
208Y/120 V, 3-phase Wye, 4-wire + ground	208-3Y
380Y/220 V, 3-phase Wye, 4-wire + ground	380-3Y
400Y/230 V, 3-phase Wye, 4-wire + ground	400-3Y
415Y/240 V, 3-phase Wye, 4-wire + ground	415-3Y
480Y/277 V, 3-phase Wye, 4-wire + ground	480-3Y
600Y/347 V, 3-phase Wye, 4-wire + ground	600-3Y
208 V, 3-phase Delta, 3-wire + ground	208-3D
240 V, 3-phase Delta, 3-wire + ground	240-3D
380 V, 3-Phase Delta, 3-wire + ground	380-3D
415 V, 3-phase Delta, 3-wire + ground	415-3D
480 V, 3-phase Delta, 3-wire + ground	480-3D
600 V, 3-phase Delta, 3-wire + ground	600-3D

Enclosure option	Suffix
Polycarbonate, pre-wired	P
Powder-coated metal NEMA 4, pre-wired	4
Stainless steel NEMA 4X, pre-wired	S
Polycarbonate with termination lugs	PL
Powder-coated metal NEMA 4 with termination lugs	4L
Stainless steel NEMA 4X with termination lugs	SL

Filter option	Suffix
8 UF filter *	F
No filter	N

* Standard filter

Stand-alone option (must be ordered as separate line item)	Item no.
Small Metal Flush Mount Plate	CG3FMPMMETAL
Medium Metal Flush Mount Plate	CG3FMPMEDMETAL
Small Stainless Steel Flush Mount Plate	CG3FMPMSMSS
Medium Stainless Steel Flush Mount Plate	CG3FMPMEDSS
Metal Disconnect	CG3DISCMETAL
Stainless Steel Disconnect	CG3DISCSTEEL
DTS-2 diagnostic test kit	DTS

Product specifications

Electrical	
Maximum surge current rating	80 kA per mode, 160 kA per phase
Nominal discharge current rating (L-N)	20 kA
Operating frequency	47–63 Hz
Connection method	Pre-wired with 36 inches of #6 AWG conductor (P, 4 or S enclosure suffix) or termination lugs for #10–#4 AWG conductor (PL, 4L or SL enclosure suffix)
Modes of protection	All modes (L-N, L-G, N-G, L-L)
Fault rating (SCCR)	200 kAIC — no upstream over-current protection device (breaker or fuse) required
Monitoring	Surge counter, tri-color LEDs (one per phase), dry relay contacts, audible alarm, alarm silence button, fault light
Repetitive surge current rating	3,000 impulses per mode based on actual test data (using ABSI/IEEE C642.41.1-2002 C3 combo wave)
Application	ANSI/IEEE C62.41.1 locations A, B and C ideal for distribution panels, branch panels and critical loads

Mechanical	
Installation location	Indoor or outdoor
Mounting method	Dual mounting flanges
Operating environment	-40 °F to 149 °F (-40 °C to +65 °C)
Altitude	5%–95% non-condensing humidity 0–12,000 ft (3.66 km)
Product design	Individual thermally fused MOV technology

EMI/RFI filter attenuation	
Mil Standard 220B	Up to 40 dB from 10 kHz to 100 MHz

Regulatory	
cULus 1449 4th Edition	VZCA: E316636 Type 1
UL 1283 with filter option	Yes
UL96A compliant	Yes
IEEE C62.62.41.1, C62.41.2, C62.45	Yes
NFPA 70 (NEC), Article 285	Yes
RoHs compliant	Yes
Listed by	UL

Warranty	
	15 years

Performance data

Model no.	System voltage	Protective mode	MCOV	B3 ring wave, 6 kV, 500 A	B3/C1 combo wave, 6 kV, 3 kA	C3 combo wave, 20 kV, 10 kA	UL 1449 4th edition, 6 kV, 3 kA VPR
CGP3-080-120-1G	120 V	L-N	150 V	329 V	554 V	765 V	600 V
CGP3-080-127-1G	127 V	L-G	150 V	386 V	587 V	863 V	600 V
		N-G	150 V	518 V	552 V	860 V	600 V
CGP3-080-220-1G	220 V	L-N	320 V	311 V	949 V	1339 V	1000 V
CGP3-080-230-1G	230 V	L-G	320 V	975 V	1021 V	1298 V	1200 V
CGP3-080-240-1G	240 V	N-G	320 V	954 V	962 V	1339 V	1000 V
CGP3-080-277-1G	270 V						
CGP3-080-347-1G	347 V	L-N	420 V	376 V	1290 V	1555 V	1500 V
		L-G	420 V	1180 V	1322 V	1627 V	1500 V
		N-G	420 V	1180 V	1285 V	1617 V	1500V
CGP3-080-240-2G	240/120 V	L-N	150 V	329 V	554 V	765 V	600 V
CGP3-080-208-3Y	208 Y/120 V	L-G	150 V	386 V	587 V	863 V	600 V
		N-G	150 V	518 V	552 V	860 V	600 V
		L-L	300 V	318 V	915 V	1112 V	1000 V
CGP3-080-480-2G	480/240 V	L-N	320 V	311 V	949 V	1339 V	1000 V
CGP3-080-380-3Y	380 Y/220 V	L-G	320 V	975 V	1021 V	1318 V	1200 V
CGP3-080-400-3Y	400 Y/230 V	N-G	320 V	954 V	962 V	1339 V	1000 V
CGP3-080-415-3Y	415 Y/240 V	L-L	640 V	387 V	1735 V	2101 V	1800 V
CGP3-080-480-3Y	480 Y/277 V						
CGP3-080-600-2G	600/347 V	L-N	420 V	376 V	1209 V	1555 V	1500 V
CGP3-080-600-3Y	600 Y/347 V	L-G	420 V	1180 V	1280 V	1627 V	1500 V
		N-G	420 V	1180 V	1282 V	1617 V	1500 V
		L-L	690 V	540 V	2203 V	2565 V	2500 V
CGP3-080-240-3H	240 Δ/120 V	L-N	150 V	329 V	554 V	765 V	600 V
		H-N	320 V	311 V	1064 V	1339 V	1200 V
		L-G	150 V	386 V	587 V	863 V	600 V
		H-G	320 V	975 V	1040 V	1298 V	1200 V
		N-G	150 V	518 V	552 V	860 V	600 V
		L-L	300 V	318 V	915 V	1112 V	1000 V
		H-L	470 V	640 V	1358 V	2104 V	1500 V
CGP3-080-208-3D	208 V	L-G	548 V	386 V	1021 V	863 V	1200 V
CGP3-080-240-3D	240 V	L-L	372 V	318 V	915 V	1112 V	1000 V
CGP3-080-415-3D	415 V	L-G	866 V	975 V	1508 V	1298 V	1800 V
CGP3-080-480-3D	480 V	L-L	357 V	387 V	1830 V	2101 V	2000 V
CGP3-080-600-3D	600 V	L-G	1225 V	1180 V	2203 V	1627 V	2500 V
		L-L	542 V	540 V	2203 V	2565 V	2500 V

Dimensions

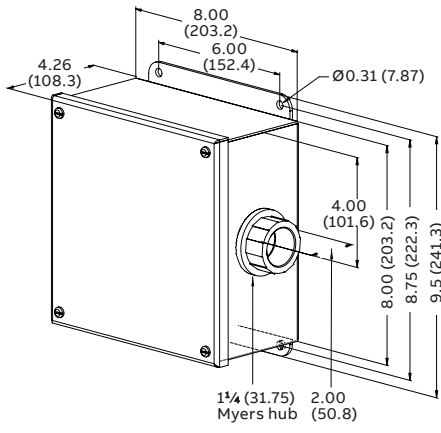

80 kA metal enclosure pre-wired
Enclosure option M

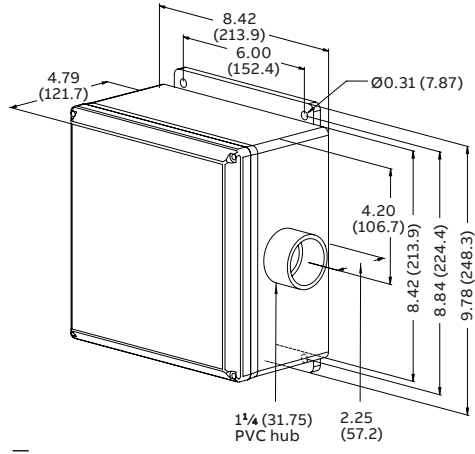

80 kA polycarbonate enclosure pre-wired
Enclosure option P

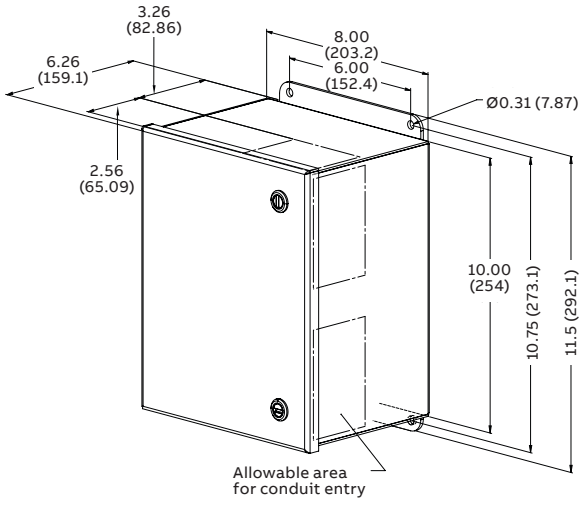

80 kA metal enclosure with lugs
Enclosure option ML

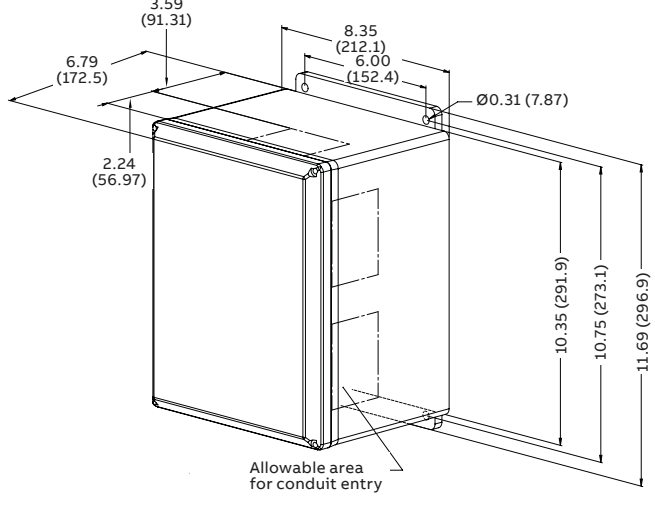

80 kA polycarbonate enclosure with lugs
Enclosure option PL

All measurements in inches (millimeters).

kA	Enclosure type	Pre-wired	Weight in lbs	Weight in kg
80	Metal	Yes	13	5.90
80	Polycarbonate	Yes	9	4.08
80	Metal	No	16	7.26
80	Polycarbonate	No	10	4.54

ABB Inc.
860 Ridge Lake Blvd.
Memphis, TN 38120
USA

We reserve the right to make technical changes or modify the contents of this document without prior notice. With regard to purchase orders, the agreed particulars shall prevail. ABB Inc. does not accept any responsibility whatsoever for potential errors or possible lack of information in this document

We reserve all rights in this document and in the subject matter and illustrations contained therein. Any reproduction, disclosure to third parties or utilization of its contents – in whole or in parts – is forbidden without prior written consent of ABB Inc. Copyright © 2021 ABB