

ABB

4 | 12

The corporate
technical journal

review

Remote service for robots 18

Life expectancy management 37

Radiography for switchgear 42

Cyber security 53

Service



Power and productivity
for a better world™



Many readers will associate ABB first and foremost with the shiny new products coming out of its factories. However, life-cycle support and service are just as important to customers. As a vital and growing component of ABB's activities, the world of service presents numerous fascinating technological and logistical solutions. A selection is presented in this edition of *ABB Review*.

The front cover of this edition shows a service engineer for ABB's power generation business at work. The inside front cover photograph was taken at the Lingang workshop in Shanghai, China, where ABB builds permanent magnet generators.



Service strategies

- 7 Service and R&D**
ABB's service technologies are crucial to ensuring longevity in its products
- 13 Remote, but close**
Improving operations and maintenance with remote optimization
- 18 Global reach, local support**
ABB's global SIU organization provides local support to robots across the world
- 25 Service solutions**
A look at what is to come

Aspects of service

- 32 Fingerprint analysis**
Optimizing boiler efficiency pays off
- 37 Productive predictions**
Life expectancy analysis improves maintenance management of high-voltage motors and generators
- 42 Seeing through switchgear**
Radiographic inspection saves costs and downtime and enables better maintenance planning
- 46 Always in touch**
Adapting mobile devices to industrial applications

Service consulting

- 53 Protection from cyber threats**
Can utilities and industries afford a cyber security breach?
- 59 Sustainable energy reductions**
ABB's industrial energy efficiency solutions are delivering accelerated energy savings to industry

Challenges and solutions

- 64 Texas transformed**
Achieving significant savings through a new electricity market management system
- 72 Engineering success in Thailand**
Provision of services to Dow's largest manufacturing site in Asia

Index 2012

- 77 Index 2012**
The year at a glance

At your service!



Prith Banerjee

Dear Reader,

Asked what they consider the core of ABB's activities, many readers would probably think of the company's deft robots, its powerful transformers, its energy-saving drives or its smart and sophisticated automation offerings. Service, in contrast, is still considered by many to be about far more low-tech activities such as the occasional visit of a technician with a toolbox. This perception (if indeed it has ever been accurate in recent times) is becoming rapidly outdated.

Through the numerous legacy brands that ABB has inherited and the longevity of many of its products, the company combines a huge repository of expert knowledge about, and is able to effect repairs on and supply spares and upgrades for a broad range of recent and older products. Through working with its customers, ABB understands the challenges they face and can advise and support them in their maintenance and upgrade strategies. Drawing on its network of experts around the globe, the company can respond to customer queries and resolve issues rapidly. With its remote diagnosis tools, ABB can analyze the performance and health of equipment and support maintenance scheduling, helping avoid unplanned downtime and ensuring that customers get the best possible performance out of their valuable investments.

But service is not restricted to maintenance and preventing failures. ABB's service portfolio also encompasses the optimization

of processes and operations. The company can, for example, support customers in their quest for greater energy efficiency, lower operating costs or in protecting systems and equipment from cyber attacks.

Beyond providing these different levels of service for products and systems that are already hard at work on customer sites, ABB believes its products must, by virtue of their design, be built for service. The company's R&D groups are thus increasingly considering service needs from the very beginning of product development cycles. As part of this commitment, the company's R&D organization recently created the position of Group Service R&D Manager.

This issue of *ABB Review* visits a broad range of different aspects of service within the ABB group, ranging from the on-site analysis of equipment degradation to energy efficiency consulting. I trust these pages will broaden your awareness of ABB's scope in the area of service.

Enjoy your reading!

A handwritten signature in blue ink that reads "Prith Banerjee". The signature is written in a cursive, flowing style.

Prith Banerjee
Chief Technology Officer and
Executive Vice President
ABB Group







Service and R&D

ABB's service technologies are crucial to ensuring longevity in its products

CHRISTOPHER GANZ – The notion of service at ABB is likely to conjure up an image of a service vehicle driving into a customer's parking lot, and a service technician carrying tools into a plant to repair a malfunctioning product or system. To some extent, this is a valid picture. But innovative service technology is more than a car and a toolbox used to answer a customer's service request. It encompasses a wide range of solutions spanning from installation to decommissioning, with the goal of getting the most out of ABB's products and systems.

Today, the service sector, which after agriculture and manufacturing is the third or tertiary sector of the world economy, produces around three-quarters of the GDP of most industrialized nations – in the United States it is 76.7 percent and in the European Union it is 73.1 percent [1]. This sector comprises industries such as healthcare, transportation, finance and entertainment.

While industries in the primary and secondary sectors produce goods, those in the tertiary sector deliver services. According to Merriam-Webster, a service can be defined as a “useful labor that does not produce a tangible commodity.”

Services have a few key characteristics [2]. They are:

- Intangible: They cannot be touched, are not stored or transported. Consequently, a service cannot be returned if its delivery is not satisfactory.
- Perishable: A service exists during service delivery, while the service provider appoints resources for the execution of the service. Since the service is unique (see “variable” below), this particular service disappears after delivery.

Title picture

Maintenance services at Klabin's pulp and paper factory in Telêmaco Borba, Parana, Brazil



- Inseparable: The service provider and the consumer are inseparable from the service; ie, they must be in the same place at the time of the service delivery. The service may be provided automatically; therefore the service-delivering resources may be personnel or automated technology.
- Simultaneous: Services are simultaneously delivered and consumed; ie, at the same point in time (as described in “intangible” above, they cannot be stored).
- Variable/heterogeneous: Even if a service is standardized and productized, its delivery is always a unique instance of place, time and resources involved.

Although intangible and perishable, the service industry has successfully productized services (eg, financial products) similarly to tangible products, taking into account the special characteristics of services. The well-known product marketing mix (the four Ps, or product, price, place and promotion) that is applied to goods has been expanded to seven Ps (adding people, process and physical evidence) to include the needs of the service industry.

Service being inseparable and simultaneous leads to a strong focus on the process of the service delivery, to ensure that the service delivery resources are in place in time. Defining the process also addresses the variability of services. To further control this aspect of service, people are essential. Their expertise very often defines the quality of the service.

And since service is intangible and perishable, it is challenging to prove that the service has been delivered properly

The service sector produces around three-quarters of the GDP of most industrialized nations.

as ordered. Hence it is in the interest of both the provider and the consumer to have physical evidence of the service delivery.

Service at ABB

In the example mentioned above of the service technician driving to a site with a set of tools, the service technician may have been called to repair an ABB product, but he may also have been visiting

the site to perform preventive maintenance on an installation. Many of ABB's service offerings are defined around the life cycle of ABB's product and system offerings, from installation to decommissioning.

After installation and commissioning, ABB provides consumables, spare parts or replacement parts. Over the life cycle of an installation, maintenance activities may be required, either preventive on a predefined schedule, or predictive, based

on measurements and the observed behavior of the equipment. If, even with all the recommended maintenance, something breaks, an ABB service technician will quickly make

the repair on-site (or for more serious failures, the technician may take the equipment off-site for repairs) or may offer replacement units instead. If later in the life cycle, a product or system is extended, upgraded or replaced with the latest technology, the decommissioned object can be recycled or disposed of.



Many of ABB's service offerings are defined around the life cycle of ABB's product and system offerings, from installation to decommissioning.

All of these services are driven by the product life cycle. Service ensures that the solution initially delivered maintains or even increases its designed performance with as few interruptions as possible → 1.

In addition to product life-cycle services, there are more capabilities available within ABB that could be provided to customers as "labor that does not produce a tangible commodity." To properly design products and systems, ABB engineers need skills that can be directly applied for the customer's benefit.

Topics such as energy efficiency, health and safety, environmental compliance, and cyber security are addressed by ABB's R&D and engineering experts. Those capabilities that are normally applied to develop and produce goods can be applied to the customer's plants and processes as services.

Service technology challenges

Although people play an important role in delivering services, technology is equally important in many service industries. Air transport or healthcare services cannot be provided without the most advanced technology available. In the same vein, ABB's service delivery also depends on a number of technologies.

For many offerings, customers rely on ABB service to keep plant availability up. From this high-level requirement, a few conclusions can be drawn. Availability is the relationship between mean time between failures (MTBF) and mean downtime (MDT):

$$A_o = \frac{MTBF}{MTBF + MDT},$$

where MDT represents the total time a plant is down, comprising planned maintenance time and unplanned repair time (ie, mean time to repair, or MTTR).

The variable most obviously influenced by service is MTTR. The more efficiently a failure is repaired, the sooner the plant can run again, and availability can thus be kept high. To achieve this, the serviceability of an installation has to be optimized throughout the service value chain.

Disassembly

In order to quickly fix a problem in an installation (ie, a product or system), it is essential that disassembly as well as reassembly can be performed expeditiously. Device development today places a lot of focus on product cost, and one way to keep it low is to reduce assembly costs. As a result, the design may not necessarily allow for easy disassembly.



A key technology for efficient service is therefore the ability to disassemble a component. Furthermore, initial assembly is done in the defined factory environment, whereas maintenance and repair is typically done on-site, where heavy equipment may not be readily available. This might require special

other, and cause and effect can often be indistinguishable. To better diagnose a failure, there are several technologies available to support a service technician.

Diagnostic tools have become more and more sophisticated. Operational data is analyzed for typical failure patterns, or matched against modeled system behavior. For components that are automatically controlled and monitored, this functionality may be available in the control device. For

The more efficiently a failure is repaired, the sooner the plant can run again, and availability can thus be kept high.

tools or operating instructions to bring the system into a serviceable state. Thus, the easier it is to disassemble the component, the faster the system can be serviced.

Fault diagnosis

To efficiently service a component – to bring the right tools and spare parts to the site – it is essential that the fault is properly diagnosed. In complex systems, it is very often not clear what caused a failure, what needs to be fixed to bring the plant back online and what needs to be corrected to prevent future failures. Components frequently influence each

more complex diagnostics, data can be collected from the device and analyzed by special tools that might be operated remotely by experts.

Other sources of information also may be helpful to quickly find the source of a fault. Databases containing statistical analyses of past product failures, eg, can give an indication. This may then be paired with recommendations from knowledge-based systems that map the plant situation with past experience.

These diagnostic systems need to be available to the service technician in the field. However, to send the person with the right expertise, carrying the appropriate tools and spare parts, it is beneficial if a system can be diagnosed remotely before someone travels to site → 2.

Expert knowledge

This indicates another key technology that is required for service: the ability to make expert knowledge available wherever needed. Most obviously, this is done by bringing the expert on site. However, since there are few “top experts,” it is essential that their knowledge is made more widely available by, for example, mapping their experiences in a knowledge-based system, or by allowing them to access plant data and to guide the field technician remotely.

Keeping MTBF high

These are technologies that help keep repair time to a minimum. Going back to the availability equation, there is still another variable that can be influenced. Repair time is lowest if no repair is ever necessary; ie, if MTBF is high. Of course every customer’s dream installation has

comes at a price since the maintenance time adds to the plant downtime. However, since the planned downtime of a plant can be scheduled in times of low business, and multiple maintenance actions can be executed during the same outage, the operational costs of a planned outage are much lower than a plant trip during high production.

To improve downtime due to scheduled maintenance, the same parameters used in the repair intervention are important – not only repair, but also maintenance activities need to be executed quickly and efficiently. If tools and technologies are available that allow a plant to be maintained while in full production (eg, redundant system, live maintenance), downtime can be further reduced.

Plant lifetime prediction

The most desired service technology, however, is plant lifetime prediction, which enables precise prediction of when a component will fail. Service intervals do not need to be set on the safe side, but instead maintenance could be done when optimally required. A plant is continuously monitored for patterns that predict a failure in the making. However, precise predictions will always be elusive, but will nevertheless remain the goal of service technology.

The products and systems delivered by ABB are carefully engineered to work together to provide customers with the desired plant functionality. Service addresses yet another dimension of complexity in the system installed at a plant – it ensures that the functionality is provided over time. Service technology helps to track plant behavior over time, to detect malfunctions, off-specification operation, and failing devices, and to support customers in requesting service and maintenance at the optimum time. Furthermore, service technology enables technicians to efficiently maintain a plant or repair a failure to keep plant availability high → 3. One of the challenges continually addressed by service technology is not only to think about how components work together, but also to consider how they are kept operational over time.

The products and systems delivered by ABB are carefully engineered to work together to provide customers with the desired plant functionality.

To efficiently service a component – to bring the right tools and spare parts to the site – it is essential that the fault is properly diagnosed.

an infinite MTBF and does not need to be serviced at all, but apart from the impossibility of achieving this in a technical environment, the resulting cost for such a product would be too high.

Still, ABB’s R&D experts aim to make products as reliable as reasonably possible. And in addition, a clever service strategy can keep MTBF high. With preventive maintenance actions, an installation is maintained in a state that prevents failures. Looking at the availability formula of the maintained plant again, this

Christopher Ganz

ABB Group Service
Zurich, Switzerland
christopher.ganz@ch.abb.com

References

- [1] Central Intelligence Agency (2011). *The World Factbook 2011*.
- [2] Retrieved from http://en.wikipedia.org/wiki/Service_%28economics%29 August 24, 2012.

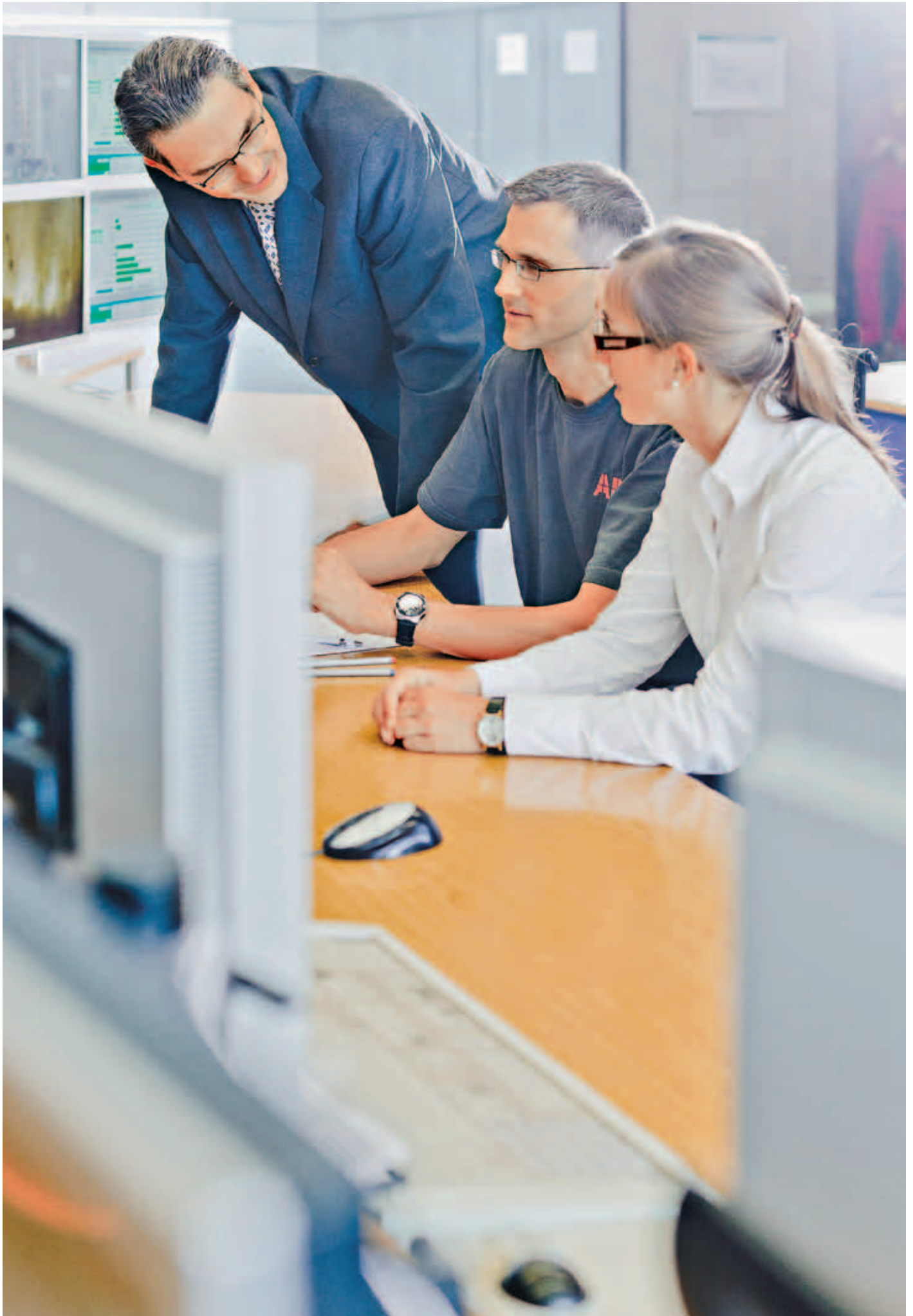

Remote, but close

Improving operations and maintenance with remote optimization

MARC ANTOINE, GABRIELE NANI – For companies in the power and water businesses, keeping plants running, and running efficiently, is of vital importance. Effective maintenance programs and finely tuned operations are two elements that are critical in achieving this goal. That is why companies are increasingly turning to remote services as a source of cost-effective and efficient expertise. ABB provides remote services that help run many aspects of a plant's operations and maintenance. Providing these requires a very carefully thought-out and secure engineering and IT strategy.

Early diagnosis of equipment problems and optimization of maintenance and operations are elements that are essential for efficient operation of plants in the power and water industries.

Plant managers are expected to maximize output while keeping costs at a minimum. Some may be tempted to sacrifice maintenance expenditures for an immediate improvement in profitability, but this strategy can adversely affect longer-term profitability: Spending less on maintenance degrades equipment, which leads to poorer performance and, ultimately, to reduced productivity and product quality. The inverse strategy yields the inverse result: increased production and improved quality. A purely reactive approach to service should be replaced by one that properly balances reactive and proactive behavior → 1.

Stepwise optimization process

Companies in the power and water industries increasingly expect remote services that supplement internal and contractor on-site support and improve the effective-

ness of their operation and maintenance programs. Remote services provide expertise to the customer in a cost-effective and efficient way. Having these services available 24/7 is very beneficial to customers who are facing the dual challenge of a lack of expertise and rapidly advancing technology.

Remote service involves a three-step optimization process [1]. It usually begins with experts visiting the customer site to become familiar with the plant and

Early diagnosis of equipment problems and optimization of maintenance and operation activities are essential.

the unique characteristics of the process. Data is collected so that an initial assessment can be performed and process problems identified. Then a root cause analysis is carried out and recommendations for corrective actions are made to the customer. Once the improvement recommendations have been implemented, subsequent periodic audits are performed to make certain that the desired results have been achieved and

Title picture

More and more businesses are using ABB experts to optimize operations and maintenance in their plant. What elements have to be put in place to establish a successful remote service operation?

1 The balance between reactive and proactive services

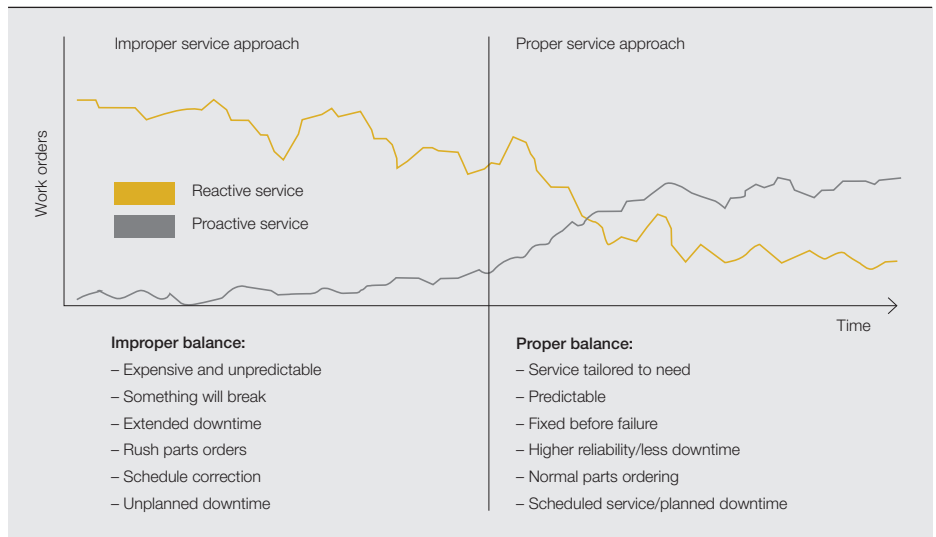

Around the clock service availability is very beneficial to customers facing the dual challenge of a lack of expertise and rapidly advancing technology.

to ensure continuous improvement. Data for subsequent assessments is gathered automatically by data collection tools or with the assistance of field service personnel. Experts remotely analyze the data and provide status reports containing additional corrective action recommendations that will sustain the process improvements achieved and enable future improvements to be made. This process can be summarized as follows:

- Diagnose: Identify existing system reliability issues.
- Implement: Deliver identified improvement services.
- Sustain: Manage and continue the improvement process.

Remote technical support

Typically, once a new system is installed, the customer will want to fine-tune performance by reconfiguring various system and process settings. Later, he may request support in troubleshooting problems. Service engineers usually need to return to the site for these tasks. The traditional way of handling these has many disadvantages: Symptoms are often forgotten; data is sometimes collected only after an issue has occurred; and data collection can be delayed while waiting for an engineer to arrive, especially when the site is distant. With remote services, however:

- Data collection and analysis begin immediately.
- Experts are brought closer to the problems (and the solutions).
- Technical collaboration shortens time-to-resolution.
- Solutions can be deployed via remote connections.

In addition, more advanced remote services can be offered to complement the above. These include periodic life-cycle reports and health checks; 24/7 priority support with one-hour response times; support via customer-controlled remote connectivity; and consolidated reporting on support activities across a fleet. And, if customers so desire, they can request a designated support engineer – a “familiar face.”

Remote FAT and training simulators

The traditional factory acceptance test (FAT) involves a customer team traveling to the factory or to a site. FATs involve high travel costs, schedule slip (if issues are discovered late on) and, because usually only limited resources are sent to a factory-based FAT, a lack of “eyes.” Remote services, however, enable the customer to access and review ongoing projects that are in the FAT phase via a dedicated and secure website. This brings many benefits:

- It is cost effective (no travel required).
- Delivery schedules are shortened by early participation.
- The FAT can be adapted to the customer schedule.
- Additional stakeholder reviews are easily possible.
- Ambiguity that may result in costly changes is eliminated.
- Approval waiting time is reduced and the need for an on-site FAT may be eliminated.
- Communication between project participants is improved and costly errors caused by late, inconsistent or misinterpreted data is avoided.

2 Remote access platform (RAP)

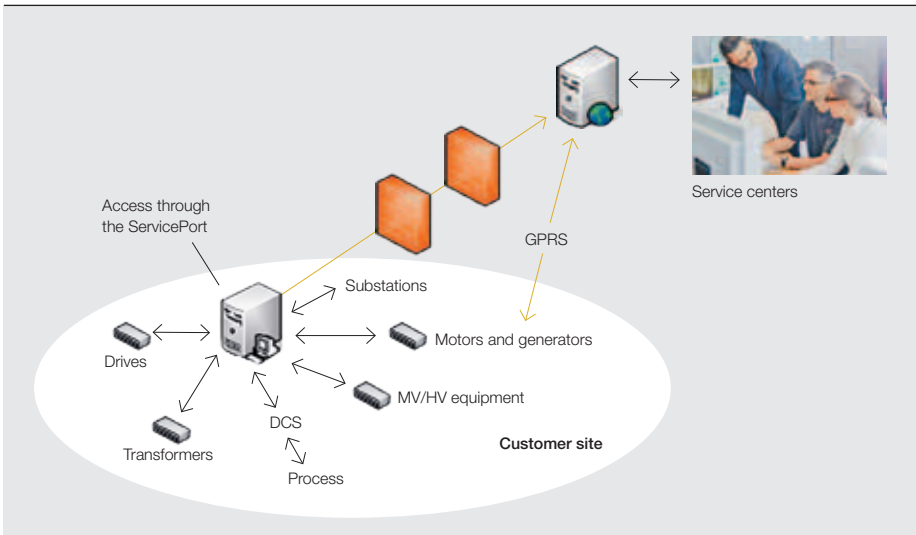

In addition, the customer has the option of using remote training simulators located at the factory instead of having to purchase and maintain these himself.

Remote secure access

The remote access platform (RAP) provides remote connection security between the service center and the customer site. RAP components, which have full redundancy and security controls, are monitored on the service center side around the clock for correct operation.

RAP enables secure, real-time remote monitoring and control of devices located at customer sites → 2. It also provides audit and security features, including audit logs to track user and application access.

Secure data transmission

The RAP and the service center perform two-way authentication prior to initiating communication. The connection is outbound from the customer site to the service center, ie, the site connects to the specific IP address(es) of its service center and always initiates the connection. This allows the customer to control and limit outbound communication.

Security and control

The customer can set granular permissions on each remote activity. Such activities include data collection, desktop sharing and file transfer.

Secure data collection

Secure data transmission begins at the source, with control over the types of data being collected for transmission. The RAP

is configurable, in that data access can be enabled or disabled based on the asset owner's security policy.

Secure user access at the service center

In addition to features that ensure smooth interoperability with existing IT infrastructures at the site, the RAP solution provides a role-based access control scheme to assign permissions. Roles are assigned to users per site. Access control is granular to the level of privileges and the actual scope of privileges for any given site is restricted. User accounts are governed by strict account management procedures, so customers can be assured that the principles of least authority and separation of duties are applied. Connections from the service center to the customer sites are also regulated by the customers, who can deny or stop such connections at any time.

Audit and traceability

RAP maintains comprehensive operational and audit logs, allowing viewing of any past service event. Additionally, the desktop sharing sessions are stored in movie format on-site and at the service center and can be viewed at any time.

ServicePort as remote service coordinator

ServicePort is a remote-enabled service interface that provides process automation systems with an on-site connection to the service center [2]. It serves as the entry point to the remote site and connects to the service center using the remote secure access mechanisms described above → 2. With fully user-

Remote service involves a three-step optimization process: diagnose, implement and sustain.

3 ServicePort

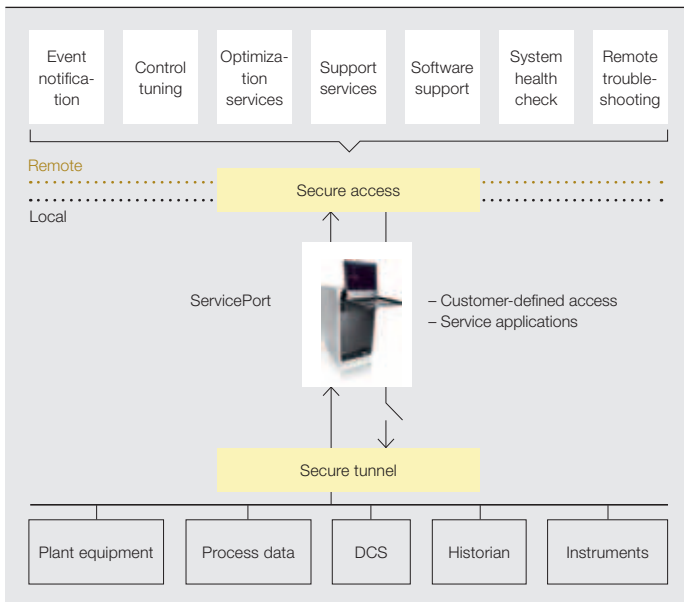

4 Remote plant maintenance

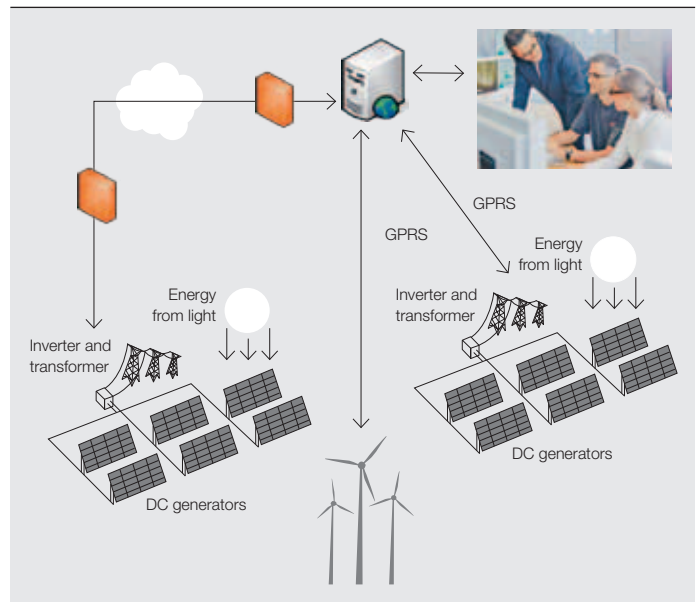

ServicePort is a remote-enabled service interface that provides process automation systems with an on-site connection to the service center.

defined security features, this on-site node acts as a service coordinator. It supports system configuration, preventive and corrective maintenance management, system diagnostics, condition monitoring, corrective implementation and service scheduling → 3.

Communication between the plant network and ServicePort is through a secure tunnel and is controlled by the customer. The benefit of ServicePort is that it enables service applications to run on-site and be readily accessible to the staff in the service center. This means no time is lost waiting for a service expert to arrive at the site.

Health checks

A fingerprint diagnostic is a fixed-scope service that identifies system performance and reliability issues through data collection and analysis. It generates both a system benchmark and an improvement plan that can be delivered either on-site or remotely, using the remote access platform. The steps in the fingerprint are those described above: diagnose, implement and sustain.

Diagnose

The initial fingerprints are used to generate performance reports that can be delivered at intervals that are based upon customer and system requirements. Fingerprints for automation systems [3,4] include measurement and analysis of system performance, network communication and controller loading.

Implement

Based on the fingerprints, improvement recommendations are determined and scheduled for implementation.

Sustain

So that the improvement process can be achieved and continued, customers are recommended to include regular fingerprint, implementation and sustaining services in their service contract.

Asset condition monitoring

Apart from remote troubleshooting and health checks, remote services are also utilized to monitor the process and plant equipment performance on a continuous basis.

Scan-type services provide a periodic performance analysis of previously fingerprinted systems. These scans can be performed at varying intervals depending on customer and system requirements and they allow for verification of post-fingerprint corrections. In addition, they search for and analyze new or recurring issues.

Track-type services provide continuous condition monitoring of a plant system and send proactive event notifications based on key performance indicators (KPIs) to designated plant personnel or to the service center. The KPIs are based on parameters reviewed and established during the scan service. Notification triggers may be based on a single KPI or a combination of several KPIs.

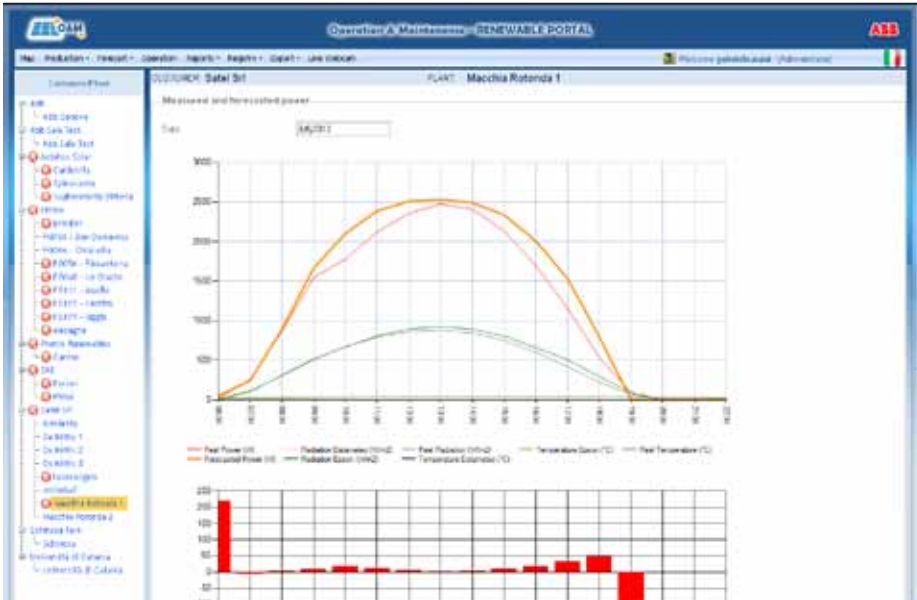

Cyber security services

ABB’s security services drive businesses towards regulatory-compliant solutions and integrity [5]. The services consist of regular site assessments that can be complemented by remote assessments, depending on the task, eg, configuration change management, access control and hardening, and compliance policy development. The services reduce complexity and labor costs through automation of tedious manual tasks. This, in turn, brings uniformity to security, compliance and change management.

Security fingerprints analyze computer- and network-based assets to determine deviations from accepted security standards. Such fingerprints give a comprehensive site cyber security status and identify strengths and weaknesses [6].

Remote full plant maintenance

Demand for remote monitoring and maintenance is increasing, especially for unattended or remotely located power plants, such as photovoltaic (PV) parks [7]. Here, the service collects real-time process data, handles alarm and failure detection and provides data reporting → 4. Besides collecting and storing real-time and historic data on all critical plant equipment, the service continuously compares performance against KPIs. Deviation from a KPI will trigger an automatic notification to a service center engineer, who will identify the source of the problem and fix it remotely, or dispatch a service team if necessary → 5.

In addition, the park operator may use the data to compare one park with another.

By combining historic weather data and next-day meteorological forecasts with the plant’s configuration, the solution’s self-learning algorithms can forecast energy production over the next 24 hours.

A full, and regularly tested, data backup service is also provided.

Increasingly remote

As the number of power and water plants around the world increases, remote monitoring is becoming a very attractive way of bringing the very best expert resources to bear on the challenge of keeping a plant running with maximum efficiency. Although site visits and face-to-face meetings with customers will remain an essential part of doing business, the role of the remote service center is set to take on an ever-increasing importance.

Marc Antoine

ABB Power Generation
Baden, Switzerland
marc.antoine@ch.abb.com

Gabriele Nani

ABB Power Generation
Genoa, Italy
gabriele.nani@it.abb.com

References

[1] Schroeder, J. (2008). Remote optimization. *ABB Review Special Report Process Automation Services & Capabilities*, 13–16.
 [2] Starr, K. Expert access – anytime, anywhere: ServicePort delivers top process expertise to anywhere in the world. *ABB Review 3/2012*, 13–17.
 [3] Harmony performance fingerprint, *ABB brochure 3BUS094565 E SM2011-027*.
 [4] 800xA Advanced system fingerprint, *ABB brochure 3BUS095466 A SM2011-261*.
 [5] Obermeier, S., Stoeter, S., Schierholz, R., Braendle, M. Cyber security: Protecting critical infrastructure in a changing world. *ABB Review 3/2012*, 64–69.
 [6] Boo, P. Protecting control systems from cyber threats. *ABB Review 4/2012*, 53–57.
 [7] Remote monitoring of PV power plants, *ABB InControl 2/2011*.



Global reach, local support

ABB's global SIU organization provides local support to robots across the world

RAJESHWAR DATTA – Remote monitoring and analysis of industrial equipment is an ideal way to ensure that the very best expertise is deployed to keep customer installations running smoothly. Remote solutions generally have three main elements: the technology to collect data at the customer's site and deliver it to a central location; a portal to select and display meaningful information to service engineers; and a back-end organization that can intelligently interpret and act on the site data. Traditionally, this last element has been provided by an entity local to the customer. However, increasing trends toward

cooperation across a shrinking cyber world have brought into focus a much better solution. This innovative approach gathers the very best resources together in one global organization to serve multiple countries. Thus, this dedicated remote monitoring and analysis organization, can develop and share specialized experience, as well as strategies and technologies, across countries. All this delivers timely, cost effective and best quality support, thereby benefitting both end customers and ABB. What is involved in setting up such a global organization and integrating it smoothly with the business?



Local ABB organizations have remote monitoring personnel, but in some cases it may be better to create one worldwide, specialized organization.

Remote monitoring and analysis services are becoming more popular and are likely to be a dominant way of providing service in the future. ABB has many businesses that already feature such services and others that foresee a heavy dependence on them in the future. Increasingly, the complexity of remotely collected data is such that it requires specially trained and dedicated personnel to interpret and act on it. Up until now, local ABB organizations have tended to supply such personnel, but in some cases it may be better to create one specialized organization to support the worldwide business.

Developing such an organization “off-line”, building its resource competence, equipping it with proper tools, defining its working processes and deliverables, positioning it appropriately in the global structure, and, finally, “sliding” it into daily operation with minimum disruption and maximum gain, poses unique challenges. However, just such an exer-

cise for ABB’s global robotics business was recently carried out with great success.

Remote service

Remote services suit ABB’s robotics business particularly well because cost of downtime is particularly high in many cases. Until now, remote solutions depended on local resources. However, this mode of delivery was not optimal because skilled resources were sometimes lacking locally. Also, the remote data usually triggered reactive rather than proactive support.

In 2009, ABB set up a service intelligence unit (SIU) – a hub of expert resources – for its robotics business. The goal was to smoothly integrate this new global level-three support entity into the existing structure of the ABB support organization. Traditionally, product support is structured in four levels and level three is a regional support resource:

- Level one: the local front-end traveling service engineering resources

- Level two: local back-office support to help Level one if needed.
- Level three: region or supranational resources
- Level four: support from the factory or the relevant R&D organization

The customers of this new SIU, then, are the local ABB robotics business representatives, especially level two, and possibly level one, engineers. They use the SIU to deliver improved remote service to their end customers.

Operationally, setting up the SIU involved putting in place expert resources, processes and tools, as well as building personnel competence, and establishing SIU interfaces with the workflows of the local organizations → 1.

Title picture

ABB’s robotics business successfully established a remote service organization. This provided not only a perfect support tool for the robotics business, but also gave an ideal template for other ABB business areas and a launchpad for future expansion of service offerings.

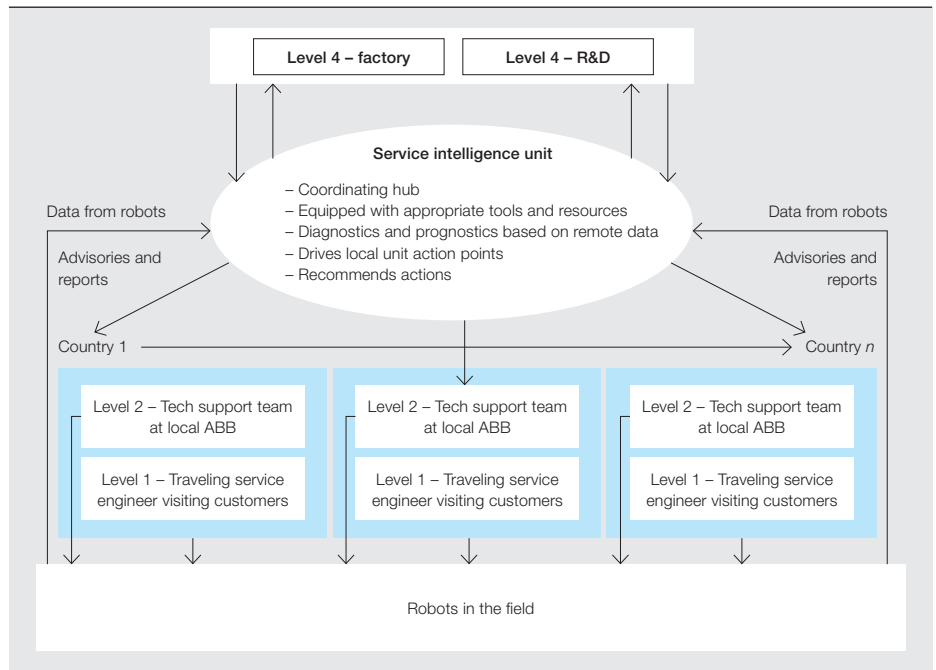

The SIU's short-term mission is optimally to support existing remote service agreements; long term, it is to help make new service offerings.

In the short term, the SIU's mission is to optimally support existing remote service agreements. In the long term, the mission is to exploit the potential of remote data in structuring and offering new services. Additionally, the door has been left open for future optimization of the service delivery model.

Specifically, the SIU's goals are to:

- Maximize customer satisfaction, reflected in renewed service contracts.
- Support countries lacking adequate resources.
- Exploit prognostic intelligence to target 24/7 customer uptime.
- Reduce turnaround time: adopt aggressive, proactive posture to alarms (response time less than 1 hour now and 3 minutes in the future).

Results

Since November 2009, the SIU has grown in strength from 1 to 9 people and still growing. The roadmap included a "learning by doing" pilot run involving collaboration with local units that had the acknowledged best practice in robotics services → 2. The SIU opened its doors as an operational entity in November 2010. Since then it has improved upon the existing best practices and has striven to enhance the quality of its deliverables. A key SIU service is to coach relevant countries on these best practices. As of September 2012, the SIU is supporting roughly 1,200 robots in seven countries with another eight countries poised to engage shortly. The SIU expects that by the end of 2012, it would be supporting much of the global installed base of remote-service-equipped robots. This could easily include 3,000 robots in more than 35 countries. There could be multiple shifts in the future.

The SIU menu of services to local ABB units comprises the following offerings:

- Troubleshooting reports: advisories that help local service engineers diagnose and troubleshoot alarms
- Watchdog reports: management monitoring and control tool that allows local management to monitor the efficiency and effectiveness of remote service delivery.
- Advanced condition reports: instruments of customer relationship

2 SIU competency building, scope of activities, scale-up strategy, history and status

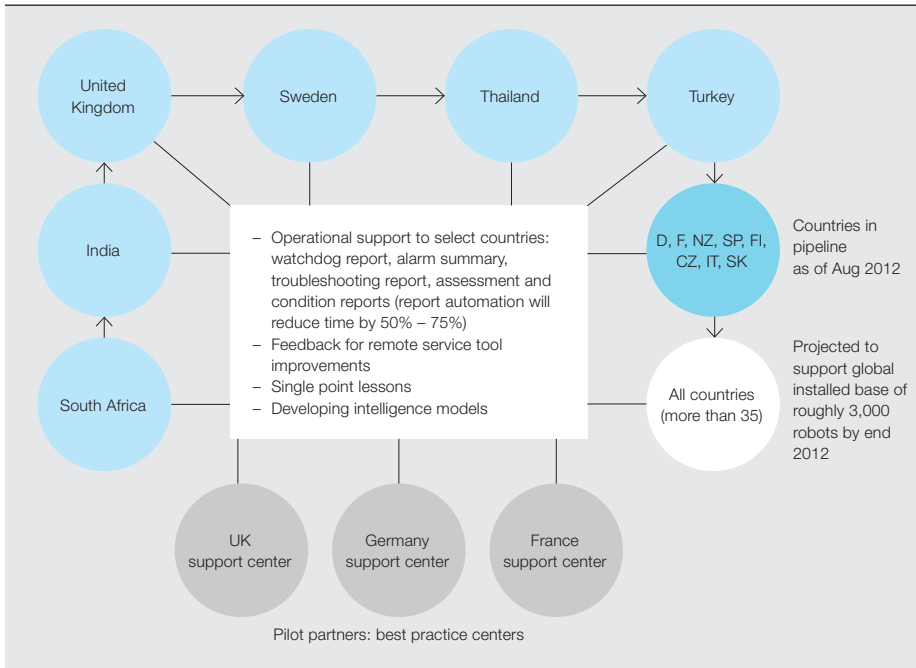

management that provide periodic summaries of robot performance for end customers. These enable regular customer interactions and their tailored observations and recommendations help customers best utilize their assets.

- Standard support: alarm monitoring and critical alarm screening (without troubleshooting advise) for local units to optimally focus resources.

The SIU seeks continually to improve its menu of services. For existing support agreements this means constantly seeking to decrease mean time to repair (MTTR) and increase mean time between failures (MTBF). For future business it means developing predictive services selling “maximum uptime” not “minimum downtime.” To develop the ability to offer such predictive services, the SIU engages in innovative research to extract predictive service intelligence from remotely collected data.

Impact

The SIU has now become an “intelligent” competence hub, staffed by trained and field-experienced service engineers who are especially skilled in interpreting and responding to data collected from robots worldwide. It generates various kinds of timely advisories and reports, with prompt and proactive recommendations and assessments. Global demand for SIU service is growing.

Knowledge generation and knowledge management are key SIU activities. As part of knowledge generation, the SIU engages in research to develop service intelligence that is used to make recommendations and assessments. Collaborative research with top-flight internal ABB resources, such as the global corporate research organizations, and external resources, means the most progressive practices are implemented. Predictive fault models based on remote data are a good example of output from this research. Such predictive capabilities can open doors for new revenue-generating service agreements. Prognostics services can deliver maximum uptime by proactively avoiding problems rather than minimum downtime by reacting to them.

In addition to developing predictive models, the SIU creates single point lessons (SPLs) as part of knowledge generation. SPLs are a “one-stop shop” for complete information on diagnosing and troubleshooting commonly occurring alarms. Both the “outside-in” field experience of SIU engineers and “inside-out” perspective of a system architect come together to make these SPLs very comprehensive indeed. These innovative exercises constantly push the boundaries of data interpretation. The outcome is maximized uptime for customers through effective troubleshooting and timely preventive maintenance.

As of August 2012, the SIU is supporting roughly 1,200 robots in seven countries with another eight countries poised to engage shortly.

Knowledge generation and knowledge management are key SIU activities.

3 A geographically spread virtual SIU allows “day” engineers to help “night” engineers by routing information through a coordination center.

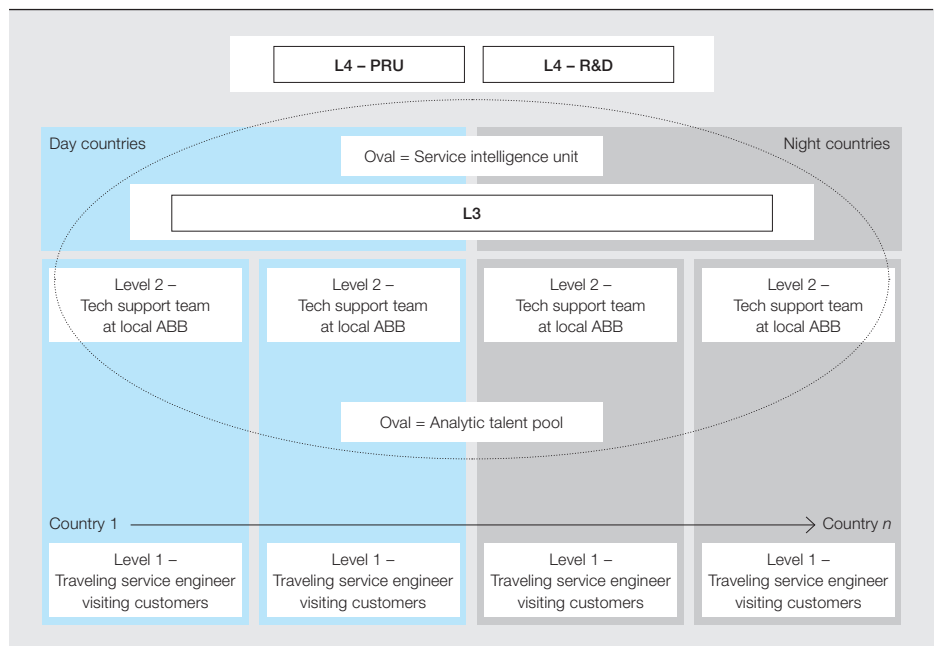

The SIU engages in knowledge management to efficiently organize and retrieve service intelligence. Research shows that up to 50 percent of the time spent on preparing for a service job goes toward searching documents and databases. The SIU has explored and engaged with leading semantic technologies and knowledge management (KM) vendors. A proof of concept mock-up of a KM tool is almost ready. When deployed, it will make all pertinent information needed to diagnose and troubleshoot a problem available at the fingertips of service engineers (remote and non-remote) worldwide. This will drastically cut service resolution time and help move toward the 3 min response-time vision.

The system will speedily and accurately scan historical cases for tips on solving the current problem. It will search service advisories, internal ABB library material and other sources for valuable insights and other relevant documented information.

Success of the robotics SIU has attracted attention from other ABB business areas, such as low-voltage drives, medium-voltage drives, motors and generators, low-voltage products and fast chargers.

Customer contact and CRM

Local ABB units interpret the technical SIU reports and contact their customers with advisories and recommendations. Thus, customers benefit from personal contact

with a local ABB service professional who has the benefit of expert SIU insights. This “local ABB face” makes for effective customer relationship management.

That local service engineers interpret SIU recommendations, instead of simply forwarding SIU reports to customers, means their skills are kept current. The closing of alarms and the service case itself remain a local responsibility too. These practices ensure that local entities stay actively involved in the service deliv-

These include the business case for establishing the new organization, its positioning in the global structure (ie level two or level three role), its customers (internal or external), the funding model, around the clock versus part-time operation, and whether the SIU is a physical center with all resources colocated or a virtual center with engineers globally dispersed but working together under one SIU umbrella.

Following the robotics example, businesses can minimize risk of disruption by spinning off such business incubator exercises. Robotics engaged a customer-service-focused group in ABB’s global corporate research organization in India for setting up the SIU. This group perfected the new

Customers benefit from personal contact with a local ABB service professional who is backed by expert SIU insights.

ery and maintain their service delivery obligations and competence.

This modus operandi allows the SIU to bolster those local units genuinely needing help, while fulfilling the ABB philosophy that “support is a local responsibility.”

Organization start-up basics

Although there is significant learning-by-doing in such an organization development exercise, some basics are obvious.

operational (SIU) model offline prior to final deployment.

Future scope

- The SIU scope will expand in many areas:
- Around the clock operation in stages
 - More automation in report writing, key performance indicator (KPI) tracking and workflow.
 - Possible integration with local units via a common administration tool (eg ticketing).

4 A possible future virtual level two and three SIU as a nucleus of a streamlined “One ABB” support delivery model

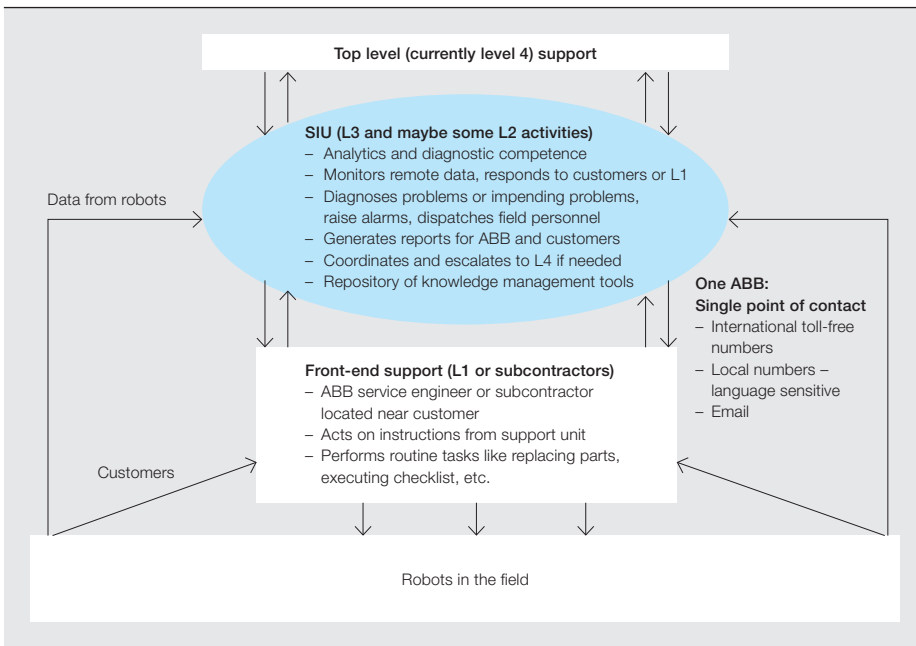

- Attainment of a case turnaround time of 3 minutes by using sophisticated knowledge management systems hosted and maintained in the SIU (Bangalore).
- Better assessment of end-customer satisfaction.
- Possible evolution of the current physical SIU nucleus to a large “virtual SIU” embracing engineers located in multiple countries. This hub would enact the “One ABB” support delivery model, accessible globally to all customers as a single point of contact for remote and non-remote cases. It would:
 - Enable engineers in “day” countries to help attend cases in “night” countries by routing information through the current physical SIU nucleus, which would act as a coordination center. This nucleus could also provide additional expertise in some cases. All this would streamline support delivery by reducing escalation layers → 3–4.

Vision: “One ABB” in action

Creating a single global organization dedicated to delivering remote services and staffed by experts is potentially a perfect solution for many ABB businesses. The experience gained from setting up the ABB robotics SIU will be invaluable when setting up similar organizations for other business units. In the future, one center of competence could evolve by exploiting the synergies

between such organizations. It could develop, share, and deliver best practices, processes, and approaches to structuring business offerings and service agreements, especially around remote information. Common technologies and tools bring down costs across a large user base. Such a unified center of competence: a service intelligence development and delivery hub (for both remote and non-remote support), would be a fine example of ‘One ABB’.

As part of knowledge generation, the SIU engages in research to develop service intelligence that is used to make recommendations and assessments.

Rajeshwar Datta

ABB Corporate Research
Bangalore, India
rajeshwar.datta@in.abb.com





Service solutions

A look at what is to come

Improved service can mean different things to different customers, and therefore ABB's corporate research centers around the world take a multidisciplinary approach to developing service solutions. Three research projects in particular are addressing different customers as well as different aspects of the service solution focus area. These are described on the following pages.

Title picture

A new software being developed by ABB can improve maintenance scheduling in industrial plants.

Workforce scheduling

SLEMAN SALIBA, MICHAEL HAMILTON, CARSTEN FRANKE – Service organizations in the utility and communications industries operate in an ever-changing environment of rising costs, complex regulations, mergers and acquisitions, and customers' high expectations of reliability, responsiveness and quality service. To meet these challenges, it is critical that utilities optimize service delivery, make efficient use of field technicians and equipment, and improve the reliability of critical assets.

With over 100,000 technicians using the system every day, Service Suite is the enterprise workforce management (EWF) solution that provides a complete platform to efficiently plan, schedule and execute all types of field work → 1. Service Suite's performance-enhancing optimizer assigns the right orders to the right technicians, based on skill and availability, and then routes them optimally between assignments to minimize travel time. This enables customers to realize significant increases in field productivity, decreased labor costs, reduced travel time and vehicle expenses, increased technician autonomy and accountability, and improved data quality.

Mathematical optimization

ABB's research centers are working with Ventyx, an ABB company, to improve the current scheduling algorithms. The goal is to introduce new scheduling algorithms to address the increasingly complex customer requirements in the field.

By watching the newest advances in mathematical scheduling optimization, the research team can include methods from integer programming, graph theory or online optimization

into Service Suite. The most suitable techniques are then chosen to be implemented in the next generation workforce management solution.

A common problem in workforce management is the allocation of skilled technicians to customer orders and the routing of technicians. The research team is developing a column generation approach with labeling to construct a near optimal schedule. Column generation with labeling proves to be the most effective method to solving complex routing problems, as explained, eg, in [1].

By using the labeling algorithm, an extensively large set of feasible routes for each service technician can be constructed. The resulting routes contain as many customer orders as

Improved planning solutions are completed by fast algorithms that respond to real time changes.

possible with a suitable skill match. The algorithm ensures that time windows for orders are fulfilled. Additionally, each route is required to comply with the legal regulations of mandatory breaks during the day and allowed overtime. For each feasible route, the labeling algorithm calculates the value of an objective function. This value represents the quality of the matching between orders and

technicians, as well as the travel times between subsequent orders in the route. Having the sets of feasible routes and their objective function value, column generation is then applied to pick the best set of routes such that each service technician serves exactly one route, each customer order is in at most one route and the objective value of the overall schedule is maximized.

This approach maximizes customer satisfaction while lowering the overall cost of service delivery and assurance, and ensures the allocation of appropriately skilled workers to each order.

Routing techniques

Another challenge is to include advanced street-level routing technologies during the optimization. This goes beyond the usage of simple navigation systems for traveling from one order to another. The accuracy of time estimations can be increased by using street-level routing technologies during the optimization of the driving routes, rather than as a post-optimization step. Therefore, the precision in the different application scenarios all around the world can be increased. Improved planning solutions are completed by fast algorithms that respond to real-time changes happening during the day, such as new urgent work, cancelled orders, or orders that technicians finish early.

The column-generation-based approach is computationally intensive, requiring a lot of computer time to optimize a schedule. However, during a working day, utilities and communication companies need to readjust the scheduling result in order to reflect real-life changes. That is, a new

1 Screen shot of Service Suite

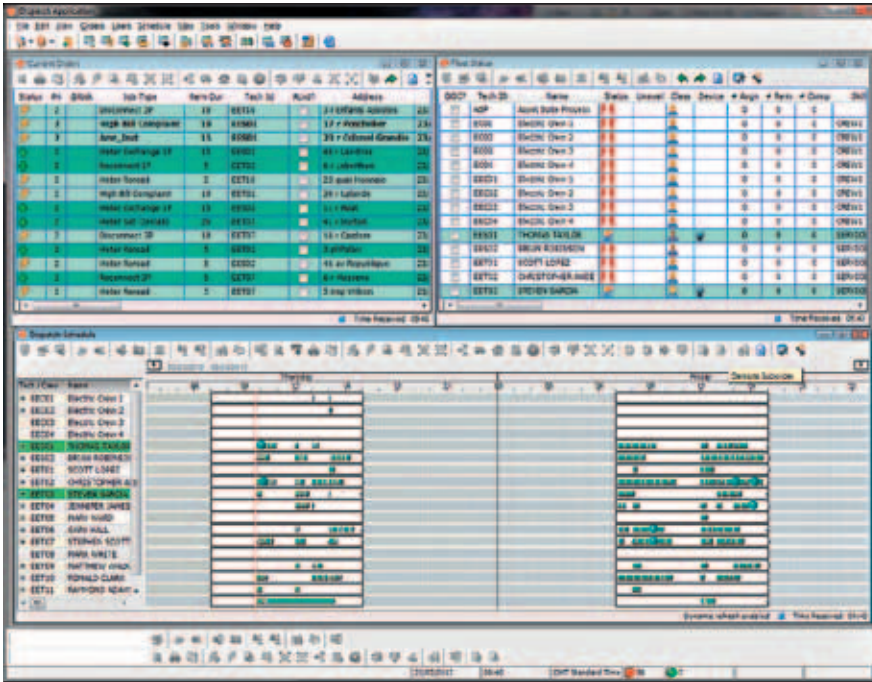

The research team can include methods from integer optimization, graph theory or online optimization into Service Suite.

task might have been added, some technicians might be unavailable due to sickness, etc.

Therefore, Service Suite must be able to readjust the solution on demand. The computation time reflecting the changes is limited to a few minutes such that the operating company can use the new solution and communicate it to the corresponding technicians in the field.

Several heuristics based on local search techniques are used to select only the most suitable subsets of orders and technicians for a new mathematical optimization run by applying the existing column generation approach. These heuristics are developed in order to react quickly and accurately to the described changes.

The heuristics take the street-level-based traveling times between orders and the already-planned orders into consideration. Furthermore, customers can choose between different heuristics to trade-off between the required solution time for the readjustment and the quality of the resulting schedule.

By drawing on expertise in different areas of the company, ABB ensures the continuation of the leading edge in the newest technologies and upcoming challenges in the service industry.

Sleman Saliba

ABB Corporate Research
Ladenburg, Germany
sleman.saliba@de.abb.com

Michael Hamilton

Ventyx, an ABB company
Richmond, Canada
michael.hamilton@ventyx.abb.com

Carsten Franke

ABB Corporate Research
Baden-Dättwil, Switzerland
carsten.franke@ch.abb.com

Reference

- [1] Desaulniers, G., Desrosiers, J., Solomon, M.M. (2005) Column generation.

Reliability feedback system

RALF GITZEL, MORITZ HOCHLEHNERT, SIMONE TURRIN – ABB's reliability feedback system project is developing tools for generator circuit breakers that can help to facilitate the paradigm shift from traditional time-based monitoring to condition-based maintenance strategies.

In many working environments there are different kinds of safety-related equipment available to prevent or mitigate situations where human life is endangered. Naturally, such equipment has to be carefully and regularly maintained. However, in many cases this results in expensive scheduled downtime. Finding the right amount of maintenance to save costs without compromising safety is not always easy.

As ABB strives to extend its core generator circuit breaker (GCB) products with increasingly complex life-cycle services, the need for appropriate tools and concepts facilitating transparency on the residual lifetime and the generated value for the customer is becoming clear.

As a result, the reliability feedback system (RFS) project has emerged. The pilot's goal was to obtain reliability data such as residual life from the field in order to help ABB service personnel recommend the right overhaul intervals for GCB to power plant owners with the RFS-GCB software prototype.

Residual life of a generator circuit breaker

A circuit breaker is a mechatronic device for interrupting the flow of current in an electrical system with a switching operation. A GCB represents a safety element in power plants, which interrupts very high fault currents (up to 250 kA) in the busbar between the generator

and main transformer → 1. Additionally, operational procedures, such as synchronization of the generator with the grid, are simplified compared with block layouts without a GCB. As a safety element, the circuit breaker is sometimes called to interrupt short-circuit currents and therefore 100 percent availability and reliability need to be assured. When used for applications with frequent use of GCB switching such as pumped storage power plants, the ablation of contacts is much higher compared with base load power plants. There, the GCB system is used to change the operation between pumping/generation mode very quickly in addition to performing its safety function.

Typical life spans are 20 to 40 years. Failures can cause critical situations in a power plant and therefore regular inspections and overhauls are important.

RFS-GCB software helps the process by using residual life information to suggest overhaul dates.

The residual life of a GCB is the amount of ablation the breaker can take before an overhaul is required. The breaker has three types of residual life; the overhaul occurs when the first reaches zero.

Electrical residual life

Each time a circuit breaker operates, its contacts get ablated and eventually are no longer functional due to cumulative ablation. The amount of ablation suffered depends on the interrupted current and has to be traced for each contact separately. (Typically, there are three phases and therefore three electrical residual life curves.) Thus, each switching operation results in a reduction of residual life, with different amounts of ablation.

Mechanical residual life

The mechanical residual life is reduced by one every time the circuit breaker is triggered. Mechanical residual life represents mechanical wear out of the system. Unlike in the electrical case, there is only one curve for mechanical residual life.

Time-based residual life

If neither the mechanical nor the electrical residual life is used up within a certain time limit, an overhaul is nevertheless conducted to account for other problems not modeled in the other residual life concepts.

Using residual life in maintenance

ABB service personnel use a myriad of information to determine the right time for the overhaul of a GCB. Long-time experience, measurements and service reports are an important part of the decision-making process. The newly developed RFS-GCB software helps the process by using residual life information to suggest possible overhaul dates. While these dates are subject to change with every extraordinary switching event, the scheduled dates are a good basis for long-term overhaul planning. Internally, a mathematical extrapolation algorithm is used to anticipate the expected future development of the residual life based on

1 A generator circuit breaker in an industrial plant.

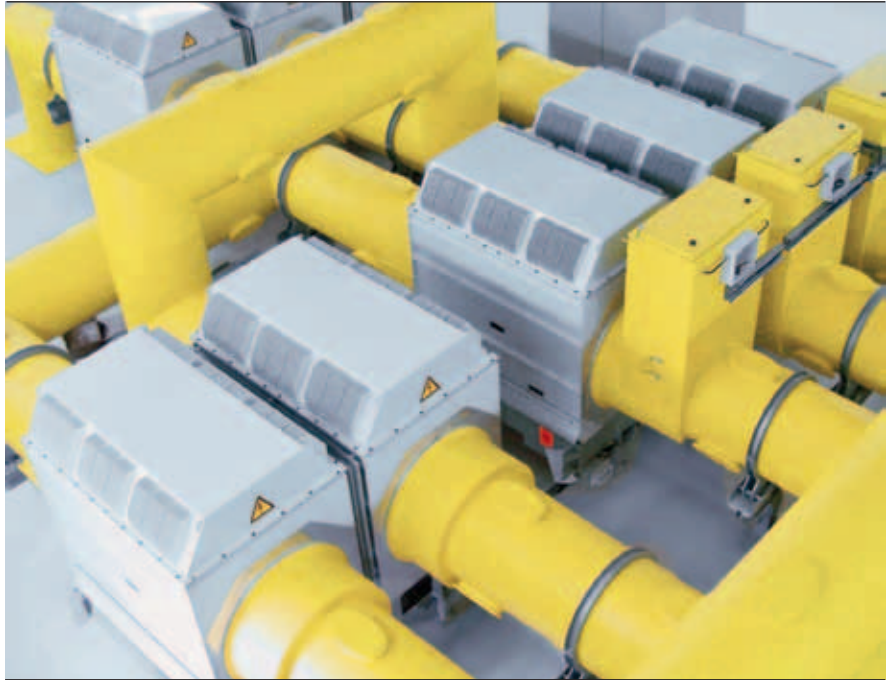

its development in the past. At the point in time where the first of the extrapolated residual life curves (ie, mechanical, electrical and time) reaches zero, an overhaul is scheduled. Naturally, the extrapolation includes a reasonable safety margin, so a residual life of zero does not mean that the GCB is no longer functional.

An overhaul plan based on residual life values can easily be created on a calendar with each kind of residual life represented by an entry marked with a tick. A calendar can be created for an individual breaker or for a whole fleet. Based on the entries, a maintenance technician can create individual maintenance plans, which make use of synergies to minimize downtime.

With GCB there are two different maintenance jobs – overhauls and inspection. An overhaul occurs when either one of the three electrical contacts' residual life reaches zero, the mechanical life reaches zero or the time limit is reached. When half of the time-based residual life is used up, an inspection should be performed. This date can also be indicated in a calendar.

Dates for overhauls/inspections can change over time. This may be caused by extraordinary, unexpected events in the GCB history. To avoid confusion, any entries on a calendar that have been moved are marked with a red cross in their old location. This way, it is always possible to keep track of the changes made to the schedule.

It should be noted that such a suggested schedule is only one input on which the service technician can base his recommendation to the customer. The

An overhaul plan based on residual life values can easily be created on a calendar.

RFS-GCB software also includes textual information on past service events and other data, which helps assess the health of the GCB. This information, together with experience and other data from the site, allows the service technician to give the customer a well-founded maintenance recommendation.

With RFS the service business would be in a position to periodically review the condition of the GCB to define and recommend service activities like inspection and electrical overhaul in a proactive manner. While RFS-GCB is still in the testing phase, it offers great potential for ABB's power plant customers to reduce their maintenance downtime while still ensuring proper operation of their GCBs. Combined with the knowledge and expertise of seasoned service technicians, RFS-GCB will provide customers with optimized schedules not only for individual breakers but also for their breaker fleet.

Ralf Gitzel

Simone Turrin

ABB Corporate Research Center
Ladenburg, Germany
ralf.gitzel@de.abb.com
simone.turrin@de.abb.com

Moritz Hochlehnert

ABB Power Products, High Voltage Products
Zurich, Switzerland
moritz.hochlehnert@ch.abb.com

Stock pooling optimization

RALF GITZEL, IIRO HARJUNKOSKI, CAJETAN T. PINTO – In many industries, motors form a crucial part of the production equipment. Due to the myriad of sizes and specifications, many customers end up having a broad collection of various motors in their plant, some of which are critical for production. The consequence of this variety is that the customer needs a large number of spare motors to cover against potential failures. Especially in older facilities, where many motors are way beyond their intended life span, special care must be taken to at least cover the mission-critical equipment.

Investing in spare motors means nonproductive spending and results in bound capital. On the other hand, too few spare motors pose a significant risk to the operability of the plant. ABB's stock pooling optimization project is currently working on a solution that can lower customers' costs without increasing the risk of downtime.

The room for cost-effective improvement in this regard, realizable by an individual customer, is limited – either the spare motors are available or not. ABB, on the other hand, is in a unique position as a motor provider to help its customers by offering a spare motor service.

Pooling effect

There is a distinctive difference between planning for a small amount of motors and for a larger fleet. For example, a single customer has a roughly 25 percent chance of needing more than 12 spare motors of a particular type in a year. However, the chance that 10 customers will need

more than 120 motors is far below 25 percent, as indicated by the quartile. Colloquially speaking, the flatter and wider green curve is less prone to unexpected behavior than the gray curve multiplied by 10 → 1. This implies that the required safety margin for the green curve is lower than the sum of all safety margins needed by single customers.

Unfortunately, with a distributed and diverse customer installed base, realizing the pooling effect requires careful consideration. Firstly, customer demand of spare motors is based on failure rates and will vary individually according to industry and plant health. This means that a careful prediction is required. Secondly, when spare motors are not stored on site, an optimized supply chain is needed to ensure that motors are available within a specified time.

A new project

The stock pooling optimization project addresses these two challenges. A multidisciplinary team of researchers working in cooperation with Carnegie Mellon University is currently developing an algorithm to reliably predict customer demand and to optimize the supply chain in order to meet this demand while realizing cost savings potential for the customers.

The current concept bases the demand forecasts for spare motors on the customer failure data. Using maintenance-related data, it is possible to calculate an annual failure rate and to make predictions using a homogeneous Poisson process (HPP). Two key parameters are determined by the prediction: The expected number of failures describing the average case, and a safety margin to

Stock pooling means less capital bound in spare motors without an increased risk of downtime.

1 Probability of motor failure

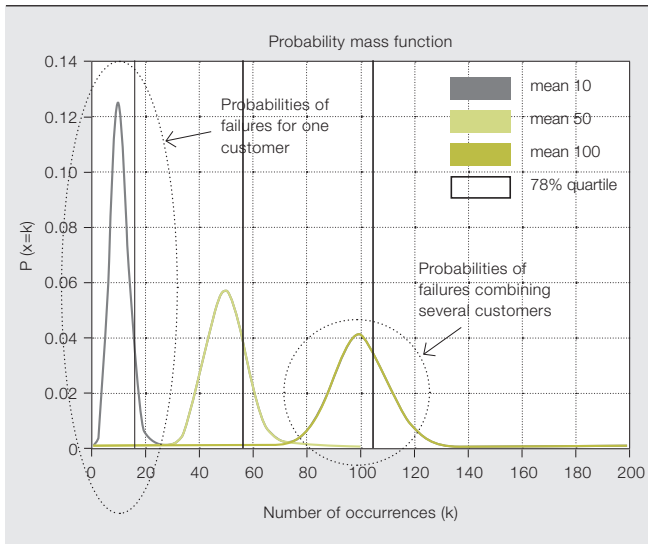

The gray curve shows the spare motor demand of a single customer for a single motor type in one year. The green curve shows the same demand for a fleet of 10 identical customers.

2 Stock pooling optimization

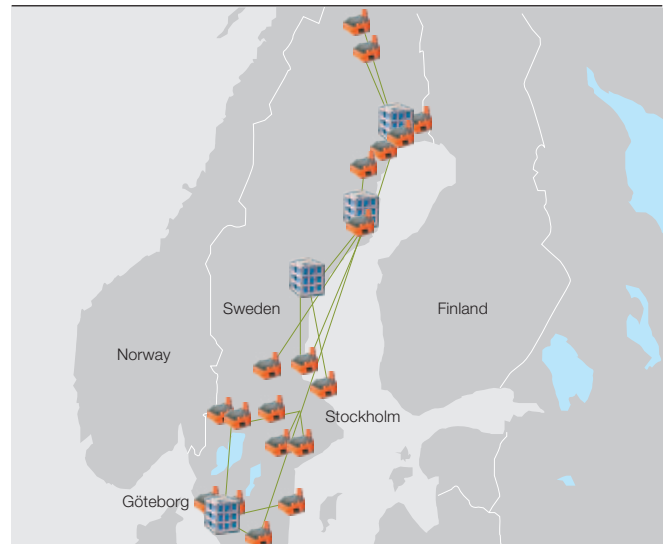

Customers are able to look at a screen shot that displays a possible solution to the supply network problem.

avoid the risk of out-of-stock, which is calculated based on the probabilities provided by the HPP.

Problem solving

To address the problem of guaranteed and timely spare motor availability, an extensive optimization problem needs to be solved. Based on motor criticality specified in contracts, the motors must be delivered before their respective deadlines. To reach this goal, a sufficient amount of motors must be stored in the correct locations without overstocking. In other words, the algorithm has to determine the optimal network of factories, warehouses and the required stock levels at the warehouses. With the software prototype, customers are able to actually look at a screen shot that displays a possible solution to the supply network problem → 2. In the context of the stock pooling optimization project, mixed-integer linear programming (MILP) will be used to find the optimal solution. The definition of the MILP model has to be done carefully; too many variables may result in an unsolvable problem due to the large size. On the other hand, if the problem model is too simple, the mathematically optimal solution may no longer reflect reality.

The stock pooling optimization algorithm is currently still under development and initial results show the great potential of a scientific approach to the problem. Trustworthy demand predictions based on established methods and supply chain optimization using state-of-the-art algorithms enable a cost-effective pooling concept and improved and more responsive spare-part service. For the customer, stock pooling means less capital bound in spare motors without an increased risk of downtime. Stock pooling could be of great benefit to a wide range of plant operators, eventually going beyond motors to include other kinds of spare parts.

Ralf Gitzel

Iiro Harjunoski

ABB Corporate Research Center
Ladenburg, Germany
ralf.gitzel@de.abb.com
iiro.harjunoski@de.abb.com

Cajetan T. Pinto

ABB Automation Products
Mumbai, India
cajetan.t.pinto@in.abb.com



Fingerprint analysis

Optimizing boiler efficiency pays off

ROBERT HORTON – Industrial boilers are used as a source of steam in a wide range of industrial settings. For many operators, the annual energy bill for their boilers will run into millions or tens of millions of dollars. Often, sophisticated monitoring and control processes are used to ensure the boilers are run in an optimal fashion, but, over time, the hardware and software responsible for this can become degraded. When large energy bills are in play, measures to avoid this degradation, and, thus, reduce energy consumption, are very welcome indeed. That is why ABB's Fingerprint analysis of such installations has become popular. The Fingerprint analysis identifies where control loops and hardware need to be refreshed or repaired and invariably leads to significant reductions in energy bills and associated carbon emissions. As an example shows, the Fingerprint analysis pays for itself in a very short time.

1 Optimization service methodology

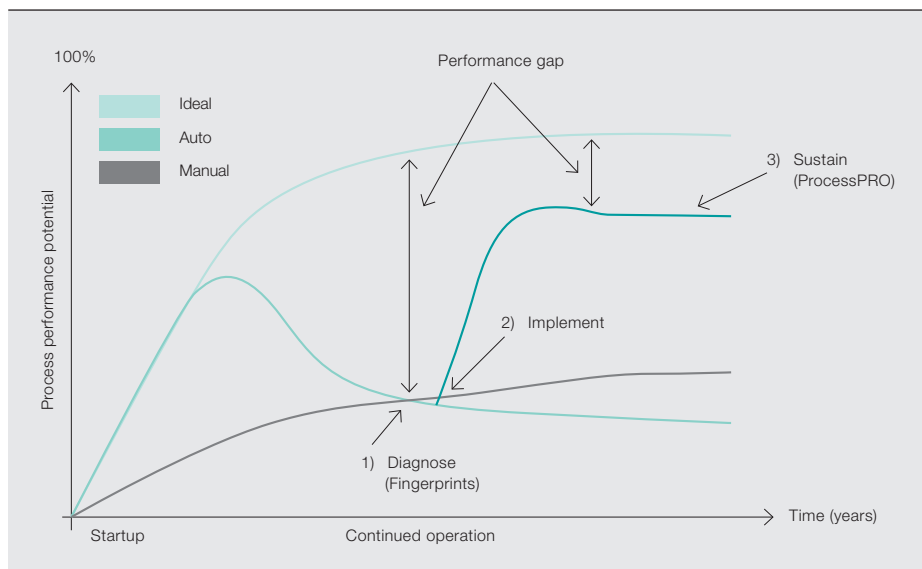

- Extended operating range for the boiler
- More reliability
- Improved safety
- Reduced carbon footprint

Loop gain

Like much industrial equipment, steam-producing boilers rely on PID controllers to regulate the process, reduce product instability and improve operations. However, ABB is finding that in PID automation:

- PID loops are not being maintained
- PID loops have degraded
- PID loops are hampering production and performance
- Associated equipment is not performing properly

Because of this, ABB has introduced a Fingerprint analysis service that will improve the performance of boilers. The Fingerprint examines the state of hardware and controls, tests the stability and operation of the boiler, performs combustion load trials and executes dynamic step response tests. In the Fingerprint process, boiler operations are first benchmarked to

mended improvements are scrutinized to estimate return on investment (ROI) and are then prioritized according to payback. Subsequent actions fix the problems and sustain performance → 1. There are three phases in the analysis:

Diagnose (Fingerprint)

- Measure performance gap
- Forecast ROI
- Deliver action plan

Implement (hands on)

- Fix performance gap
- Define monitor plan

Sustain (scan/track)

- Manage performance gap
- Schedule maintenance
- Define condition triggers
- Maintain to conditions

Back on tune

The Fingerprint that was performed on four small industrial boilers at the Arkema chemical facility at Calvert City, Kentucky, a site that includes the world's largest HFC-32 refrigerant production plant, provides a good illustration of the power of such an analysis.

The Arkema site has four boilers. These produce

steam at slightly different levels because they are different sizes and were installed at different times → 2. The first two boil-

Oil prices are a good indicator of general energy costs. From 1989 to 2003, the average price of a barrel of oil was around \$20, rising to \$50 by 2005 and peaking at nearly \$150 in mid-2008. Apart from the financial planning headaches such volatility causes, the eye-watering energy bills landing on companies' doormats bite deeply into profitability. For energy-intensive equipment like industrial boilers, the challenge is particularly acute: A 150 klb steam/hr (68,040 kg steam/hour) industrial boiler running on natural gas would have had an annual fuel bill of around \$5 million between 1989 and 2002, rising to \$10 million in 2007 and to \$20 million in 2008. Where the future trend is heading remains unclear.

One place to look for cost relief is in the hardware and software dedicated to optimizing boiler operation. Having this in good working order brings many benefits:

- Energy savings
- Better response to process steam demands

One place to look for cost relief is in the hardware and software dedicated to optimizing the boiler operation.

Title picture

Control of industrial boilers has to be kept tight to squeeze the most out of these assets. ABB's Fingerprint analysis helps do this.

define existing performance levels and establish a basis for identifying and evaluating improvement opportunities. Recom-

2 The Arkema site schematic

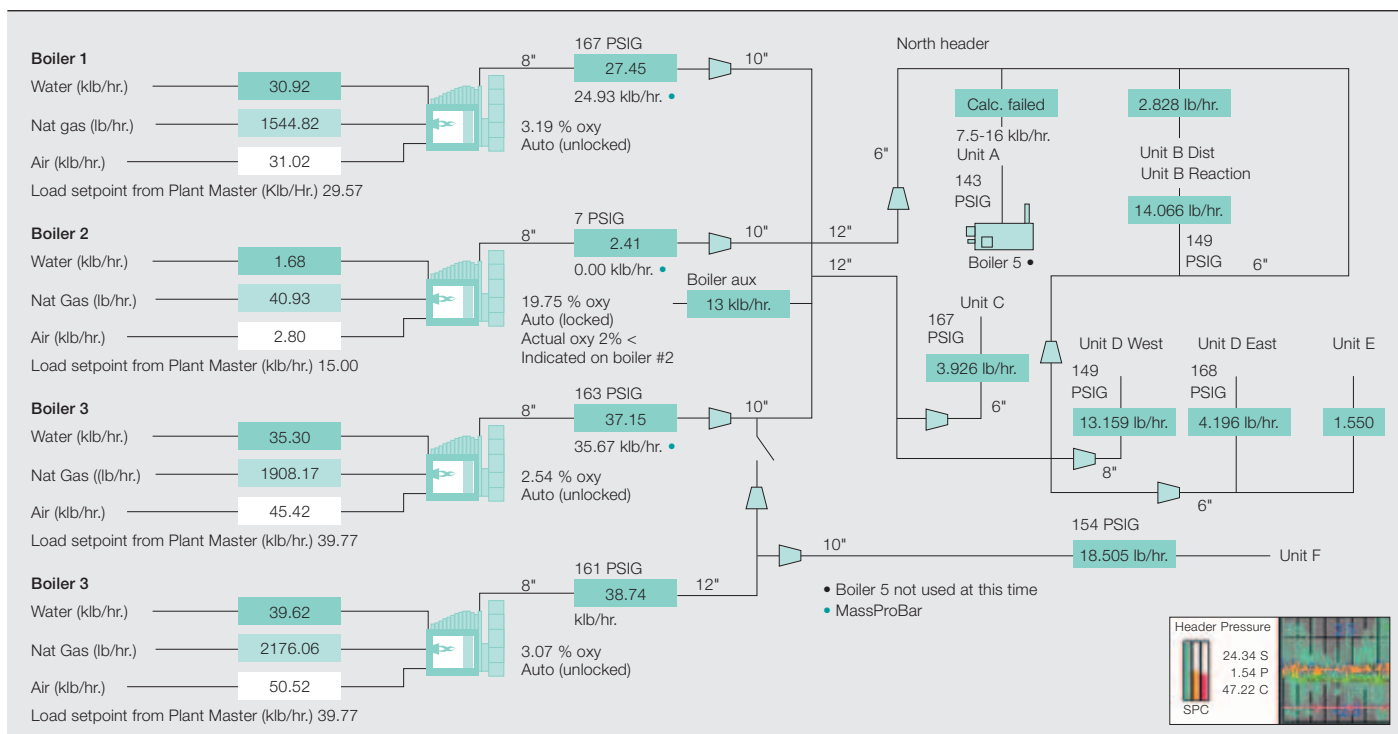

3 The forced-draft fan unit



ers, both installed in 1952, are brick-set with forced-draft (FD) intakes and induced-draft (ID) removal fans. Both are rated at 40 klb/hr. The third boiler, a 1965 economizer, has only an FD fan and is rated at 75 klb/hr, though it was typically operated at a maximum of 60 klb/hr.

The fourth boiler, a 1996 economizer, of the flue gas recirculation (FGR) type, was operated identically to the third.

All four boilers produce steam at about 165 psi, but none were run at maximum load. The Fingerprint work began with the second boiler as it is the one used most often and it is the least efficient.

Initial examination revealed that the ID fan positioner movement was jerky, indicating a potentially faulty pneumatic cylinder or piston assembly. The FD fan was also found to have issues → 3.

The ABB team noticed a loose hatch door near the oxygen sensor that was leaking air into the ductwork before the ID fan. Also, the two boiler oxygen sensors continued to read about 2 percent higher than a portable analyzer.

The leakage meant that air was being added for an oil flow that was not truly going into the boiler. Air flow and fuel flow measurements were, thus, going up and

down. They were both exhibiting hysteresis, so working against each other and creating variability.

In addition, a furnace draft test indicated leakage air was being sucked in by the ID fan and emitted from the stack as wasted power. Based on load tests, the air/fuel ratio setting was updated. (The oxygen trim that fine tunes the air/fuel ratio had been underused in recent years, leading to suboptimal operation.)

There is an industry rule-of-thumb that says that, six months after installation, the performance of around 50 percent of process control loops will be degraded to some degree. Accordingly, control loops were monitored using the Loop-scan tool and a number of deficiencies found → 4.

The Fingerprint analysis resulted in a comprehensive to-do list. The following improvements were identified for hardware:

- Repair FD and ID control drives
- Resolve oxygen transmitter reading issues: check calibration, find leak, change location
- Adequately seal all doors
- Recalibrate steam flows
- Add blowdown flow monitoring (blowdown removes solids buildup originating from the water/steam)

4 Results of control loop monitoring

Control	Process	Signal condition
C1: Manual	P1: FCE out of range	S1: Quantized
C2: Oscillating setpoint	P2: FCE size	S2: Excessive noise
C3: Deadband	P3: FCE problem	S3: Spikes
C4: Offset	P4: FCE leakage	S4: Step out
C5: Over control	P5: Intermittent disturbance	S5: Compression
C6: Slow control	P6: Persistent disturbance	S6: Over filtered
C7: FCE travel	P7: Questionable	S7: Sampling rate

FCE: Final control element

- Adjust, clean, or replace sight glass for drum level

For the control logic, this to-do list was established:

- Perform full combustion test to fine-tune steam-to-air curves, especially for oil
- Update control logic to current implementation standards
- Adjust logic to indicate when oil/gas is off
- Update excess air calculation

And for tuning, the following:

- Retune loops to be less aggressive
- Reduce output surge and ringing tendencies
- Add a small filter to the level measurement to reduce feed-water chatter
- Reduce filter on old steam flow measurement

Recommended improvements are scrutinized to estimate (ROI) and results are prioritized according to payback.

As a result of the remedial measures, oxygen readings, which had measured in the 6 to 7 percent range, were brought down to under 5 percent → 5. This reduction in oxygen levels reflects less air

drawn in, less air heated up and less air blown out, resulting in substantial fuel savings.

The approximate value in savings was \$75,000 for the second boiler alone, and all without major capital investment.

The third boiler exhibited a problem in that it would trip inexplicably during storms. The ABB team traced the source of the problem to an FD fan with a roof intake. The exposed roof position rendered it susceptible to error because wind shear affected measurements from the Pitot tubes coming off the fan intake. Arkema built a protective cover to guard against wind shear and this solved the problem.

As a bonus, it was shown that it was safe to operate the boiler at higher loads, thus getting more out of the installed capital equipment.

In all, the Fingerprint achieved a total annual plant energy savings of around \$237,000. As the service cost about \$25,000 per boiler, the payback time was very short.

The Fingerprint analysis has been applied to other industrial boiler installations, with similar success. As well as reducing energy consumption, the procedure enables clients to reduce their greenhouse gas emissions. As both these topics are likely to become more significant in coming years, so too will the ABB Fingerprint analysis service.

5 Reducing oxygen flow brings significant savings.

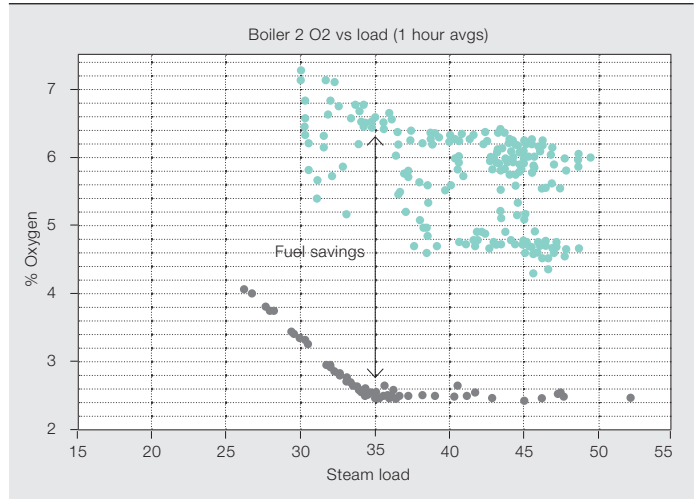

As a bonus, it was shown that it was safe to operate the boiler at higher loads, thus making more of the installed capital equipment.

Robert Horton

ABB Optimization Service
Atlanta, GA, United States
robert.horton@us.abb.com



Productive predictions

Life expectancy analysis improves maintenance management of high-voltage motors and generators

TOBIAS ÖSTERHOLM, CAJETAN T. PINTO
– By predicting the residual life of their stator windings, the ABB Life Expectancy Analysis Program (LEAP) provides a unique method for formulating a maintenance plan for high-voltage motors and generators. The method enables a predictive maintenance philosophy to replace preventive or corrective approaches. ABB LEAP supports efforts to extend motor or generator life for increased return on investment and it provides information for estimating life-cycle costs. It also offers a solid base for judgments on short- and long-term maintenance as well as run-replace decisions. This all translates into a minimum of unplanned downtime and reduced risk levels, with increased productivity and cost-efficiency.

A crucial factor to consider when planning maintenance of high-voltage (HV) motors and generators, especially those in critical industrial applications, is the life expectancy of the stator windings. HV motors and generators are typically custom-made so are not available off-the-shelf should an unexpected failure occur. This means that corrective maintenance is very time-consuming and the operator can experience extensive periods of costly, unforeseen downtime. How can such problems be predicted and avoided?

ABB LEAP for HV motors and generators can provide the answer. Based on a combination of different types of data, this service makes it possible to analyze the condition and expected life of a stator winding. This is an important part of a motor and generator life-cycle concept, in which maintenance plans are optimized for maxi-

imum user value → 1. In other words, ABB LEAP enables optimized predictive maintenance, which delivers the best long-

term user benefits when compared with, say, a maintenance strategy based on corrective maintenance alone.

Large motor failures

Large motors and generators of 2 MW rating and up are designed for high power. They exhibit a relatively higher proportion of winding failures than lower-power designs. Based on figures from an IEEE survey, 33 percent of all failures detected during normal operation are related to the stator winding → 2. However, the corresponding figure for failures detected during maintenance or testing is only 8 percent. The figures for bearings were 37 and 61 percent, respectively. It can be concluded that the prediction of winding failures needs to be improved

A crucial factor in maintenance of HV motors and generators is the life expectancy of the stator windings.

and that ABB LEAP can fill a critical gap in the maintenance toolbox of electric motors and generators.

Title picture

Stator winding failure in HV motors or generators can be highly inconvenient. How does ABB LEAP help predict stator winding lifetime?

ABB LEAP makes it possible to analyze the condition and expected life of a stator winding.

1 The life cycle of electric motors and generators depends on which approach to maintenance is selected.



ABB LEAP takes into account the aging of the stator winding insulation due to thermal, electric, mechanical and ambient factors to deliver a predicted life expectancy that has an 80 percent probability of being reached. As a result, maintenance plans can be optimized and necessary actions taken during planned downtime.

irregular conditions such as transients. The strength curve shows how operating conditions and aging influence the strength of the winding insulation. Failure occurs when these two curves cross.

ABB LEAP offers an electric motor or generator user the opportunity to preempt failure. Timely analysis allows

prediction of the stator winding's residual life and maintenance can then be scheduled to avoid premature failure and costly unplanned downtime. Knowledge of the original

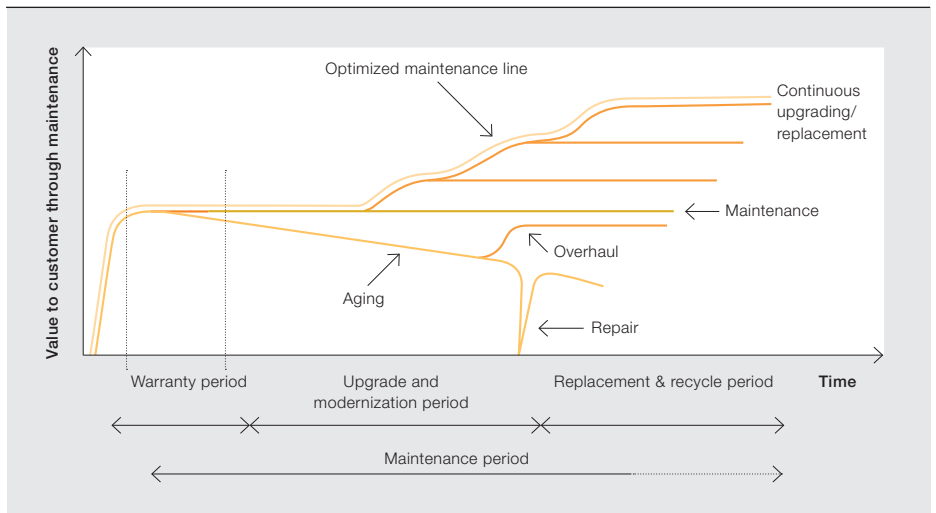
ABB LEAP offers an electric motor or generator user the opportunity to pre-empt failure.

However, ABB LEAP is more than just an inspection package. It is also a tool for systematic maintenance management. In addition, the data itself is not the key element – how it is interpreted and analyzed is the important factor.

residual life and the lifetime increase created by the maintenance measures ensure that the stress and strength curves will not meet unexpectedly.

Measurement methods

Scientifically predicting the residual life of a stator winding insulation involves a number of steps → 4.

At the heart of this approach to motor and generator life-cycle management is the understanding of how electrical stress and insulation strength vary over time and their possible effects on the device materials.

Before any analysis of a motor or generator's future prospects can be made, its present condition has to be determined. This demands knowledge of basic parameters such as operating hours, loading, number of starts, duty cycle, temperatures, maintenance history, etc. All of these factors have an impact on life expectancy and must be collected and included in the analysis.

Varying with time

The degradation of stator winding insulation can be described in general terms by using two curves to demonstrate how stress and strength change over time → 3. The stress curve shows the combined loading on the winding insulation arising from its operation, including

2 Statistics from an IEEE survey show that predictive methods are needed to avoid winding failures.

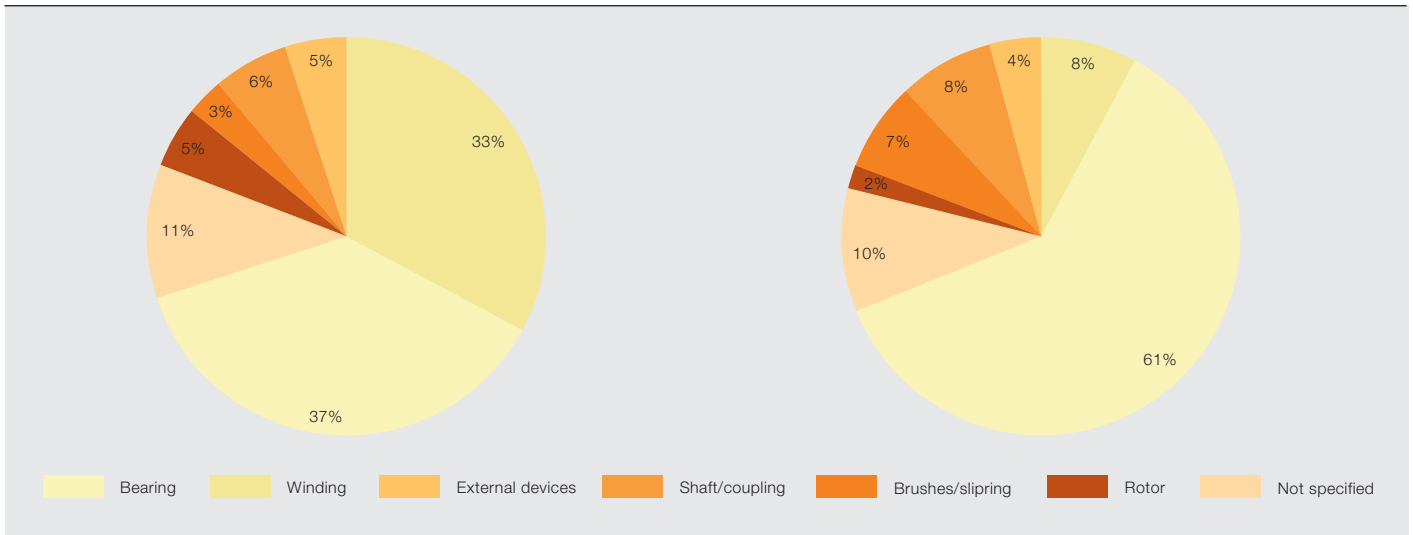

2a Detection during normal operation

2b Detection during maintenance or test

3 Electric stress and insulation strength vary over time and when the curves cross a failure occurs.



ABB LEAP is more than just an inspection package. It is also a tool for systematic maintenance management.

However, not all data is available from specification sheets and motor or generator logs. A stator winding insulation, at different stages in the aging process, has properties that can only be explored through measurements. ABB LEAP includes four main measurement methods that provide information about the conditions on the surface and within the winding insulation:

- Polarization depolarization current analysis (PDCA)
- $\tan \delta$ and capacitance analysis
- Partial discharge (PD) analysis
- Nonlinear insulation behavior analysis (NLIBA)

PDCA provides considerably more information than the more commonly used insulation resistance (IR) and polarization

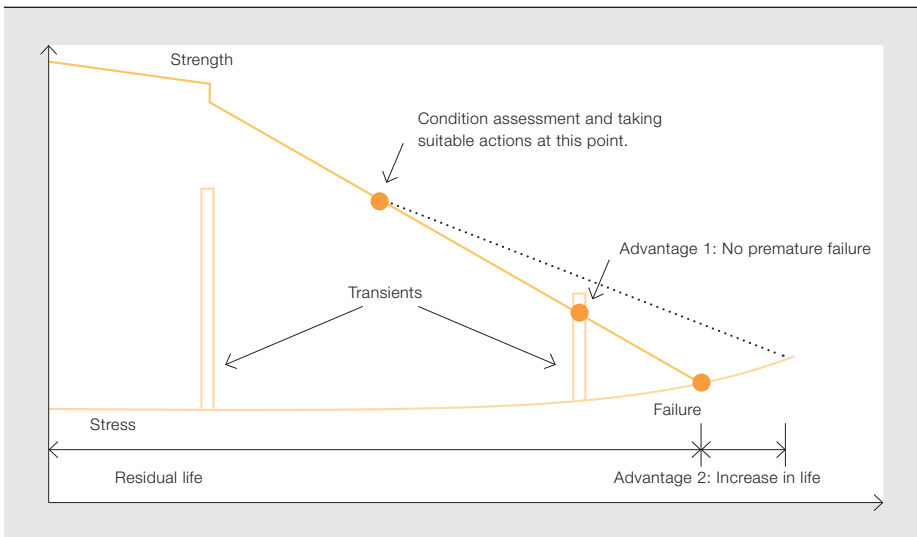
index (PI) measurements. PDCA is a DC method in which the winding insulation is initially charged and then discharged through a low-current meter to ground. Two curves are generated that describe the variation in current over time during these two steps of the measurement → 5a. From these curves, it is possible to derive a charge storage value for winding insulation and compare it to reference values for normal conditions. This allows more comprehensive analysis than if only PI and IR were utilized and the method can deliver satisfactory values even with highly contaminated windings. PDCA gives an idea of the quantity and location of charge storage within the motor or generator insulation and identifies contamination on the winding surface. It also provides additional insights into the state

of the winding insulation, including possible aging and looseness.

$\tan \delta$ and capacitance analysis is a standard method typically used before delivery of high-voltage electric motors and generators. $\tan \delta$ measurements provide an indication of the dielectric losses in the insulation. At a certain voltage, the associated curve exhibits a knee when partial discharges begin to occur in the winding → 5b. A $\tan \delta$ and capacitance analysis gives information about the extent of discharging air spaces in the insulation, condition of the resin, contamination, loose coils and other defects inside the stator insulation.

4 ABB LEAP on four levels

Level	ABB LEAP schedule in relation to estimated lifetime (%)	Motor / generator status	Action	Result
Basic	Every 5	In operation	<ul style="list-style-type: none"> – Data collection (on-site or remote), including operating hours, voltage, current, power, slip, number of starts and stops, temperature (winding, coolant, ambient), duty cycle, load pattern, failure and maintenance history, power supply, etc. 	<ul style="list-style-type: none"> – Life expectancy analysis at 65 % confidence level – Condition-based inspection and maintenance plan
Standard	Every 10	Assembled but stopped	<ul style="list-style-type: none"> – Basic data collection – PDCA – NLIBA – Tan δ/capacitance analysis – PD analysis 	<ul style="list-style-type: none"> – Condition assessment of stator windings including contamination, aging, looseness, delamination and stress grading system – Life expectancy analysis at 80 % confidence level – Condition-based inspection and maintenance plan
Advanced	Every 25	Partially dismantled	<ul style="list-style-type: none"> – Standard data collection – Visual inspection of winding ends – PD probe measurement – Dynamic mechanical winding response – Stress analysis of winding ends 	<ul style="list-style-type: none"> – Condition assessment of stator windings as in standard package, plus winding end assessment – Life expectancy analysis at 85 % confidence level – Condition-based inspection and maintenance plan
Premium	Every 50	Rotor removed	<ul style="list-style-type: none"> – Advanced data collection – Wedge tightness mapping – Coupling resistance measurements – Visual inspection, including slot areas – Stress analysis of windings 	<ul style="list-style-type: none"> – Condition assessment of stator windings as in advanced package, plus slot region assessment – Life expectancy analysis at 90 % confidence level – Condition-based inspection and maintenance plan

PD measurements are used to evaluate the extent and location of discharge activity in the stator insulation system. Partial discharges are filtered out by a coupling capacitor and terminating impedance and then recorded. Partial discharge activity is represented in one voltage cycle by the amplitude, phase and pulse count information collected over several voltage cycles → 5c. The analysis considers the amplitude and shape of the partial discharge curve on the positive and negative phase of the voltage cycle for different voltage levels. This pattern gives information about where in the stator winding partial discharges occur – for example, in the slots between the coil and stator laminations, coil ends or internal air cavities caused by insulation delamination.

NLIBA is a method unique to ABB in which the admittance of the winding insulation is analyzed. As a sophisticated complement to the tan δ and capacitance analysis, it examines the harmonics generated inside the stator winding insulation by its nonlinear behavior. The varying harmonic patterns obtained indicate different insulation conditions, and higher-order harmonics generally denote longer-progressed aging. In addition to

indicating the state of resin depolymerization, the harmonics also provide information about the condition of the corona protection shield and the stress grading system used at the slot ends.

These different measurement methods partially overlap each other in terms of what they can detect. As a result, indication of a defect from one measurement may be confirmed by another. The re-

Calculations and analysis are carried out by experts at an ABB LEAP center of excellence and are not limited to ABB-made motors or generators.

sults are also influenced by ambient factors such as temperature and humidity, which must be taken into consideration.

Whereas the PDCA method is a DC test, the others are AC-based. DC tests are sensitive to the surface condition and AC

tests give more information on the insulation volume.

Analysis

With the information above in hand, along with collected data, the next step in ABB LEAP is the analysis. This gives a total picture of the stator winding based on experience and calculations that use proprietary software with unique algorithms developed and

refined by ABB.

Over time, ABB has created a database of measurements and analyses from more than 5,000 motors and generators worldwide. This offers a solid foundation for determining the condition of a stator winding, for making stress calcula-

tions and for estimating the expected residual life → 6. Consequently, ABB LEAP is not dependent on old records of measurements performed on a certain electric motor or generator.

5 AC and DC measurements belong to the LEAP standard package

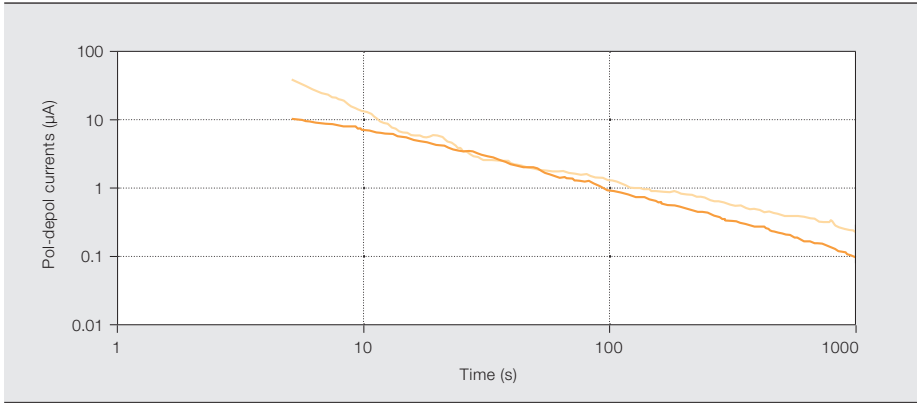

5a Variations in current with time during charge/discharge test

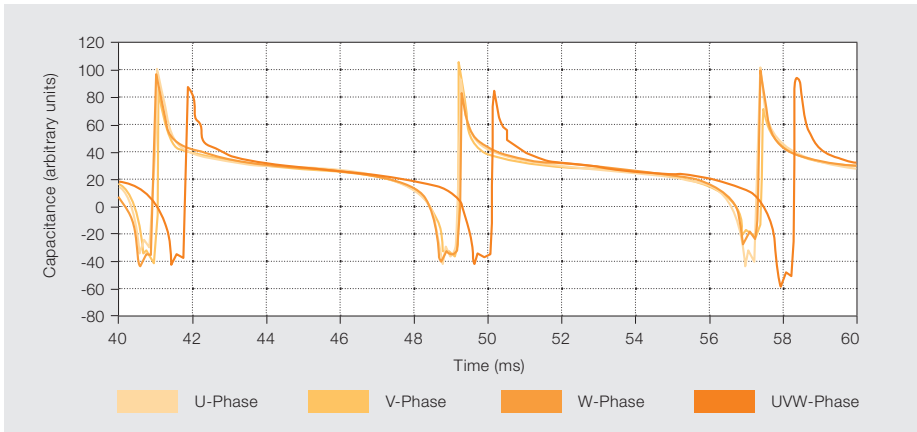

5b At a certain voltage, the curve exhibits a knee when partial discharges begin to occur in the winding.

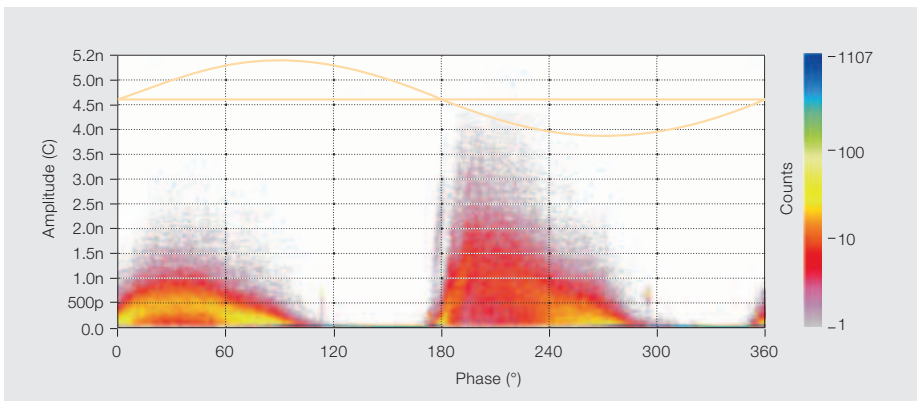

5c Partial discharge activity collected over several voltage cycles

6 Life improvement of electric motors and generators

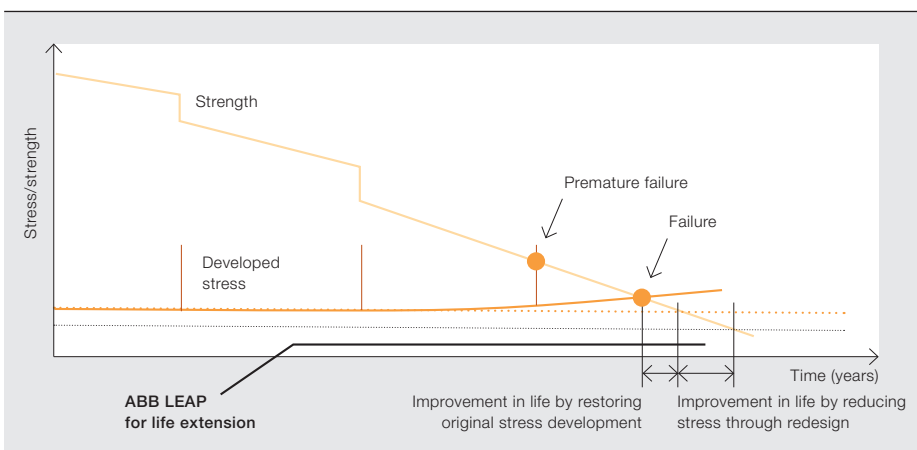

Calculations and analysis are carried out by experts at an ABB LEAP center of excellence and are not limited to ABB-made motors or generators. Customers receive comprehensive reports with analysis results, action recommendations and a remaining-life calculation. Those who need support in the implementation of recommended measures can turn to one of ABB's many service centers located around the world.

Maximize value

ABB LEAP provides operators of electric motors and generators with access to a highly accurate predictive maintenance tool that allows them to maximize the value of their motor and generator assets. As uptime and overall costs become ever more critical, ABB LEAP will help ensure operator targets are met.

Tobias Österholm

ABB Motors and Generators, Service
Västerås, Sweden
tobias.osterholm@se.abb.com

Cajetan T. Pinto

ABB Motors and Generators, Service
Mumbai, India
cajetan.t.pinto@in.abb.com

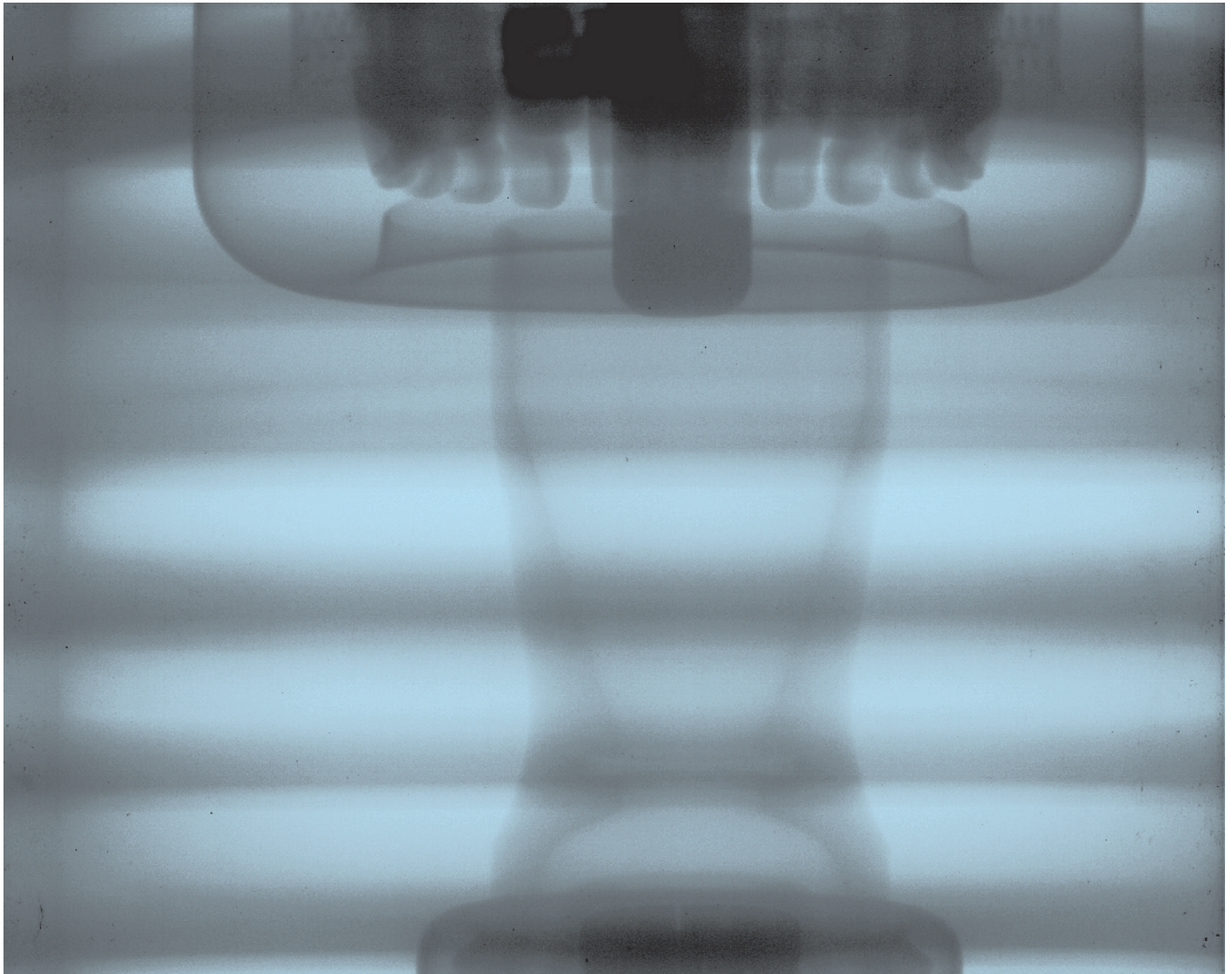

Seeing through switchgear

Radiographic inspection saves costs and downtime and enables better maintenance planning

JERRY MICHAELSON, ANDREAS MOGLESTUE – Ever since its discovery almost 120 years ago, radiography has both been both a source of fascination and a valuable tool. The stark and almost spooky grayscale photographs of our bones that we see in the hospital provide an unparalleled insight into the insides of the living body. Just as humans must sometimes visit the physician, so does switchgear require a periodic inspection. Both types of exams are there to pinpoint the causes of ailments, or proactively identify measures to prevent them. And there the somewhat superficial likeness ends. Or does it? Switchgear may not need to provide blood samples or take pills and have vaccinations, but that doesn't mean there is nothing that switchgear service cannot learn from medicine. When physicians use radiography to look inside the body, it means they do not need to use scalpels. For the patient this reduces pain, risk, costs and time. These same advantages also apply to switchgear. Equipment can be inspected without dismantling. Downtime and costs are minimized and the risk of contributing further errors or causing damage in reassembly is removed.

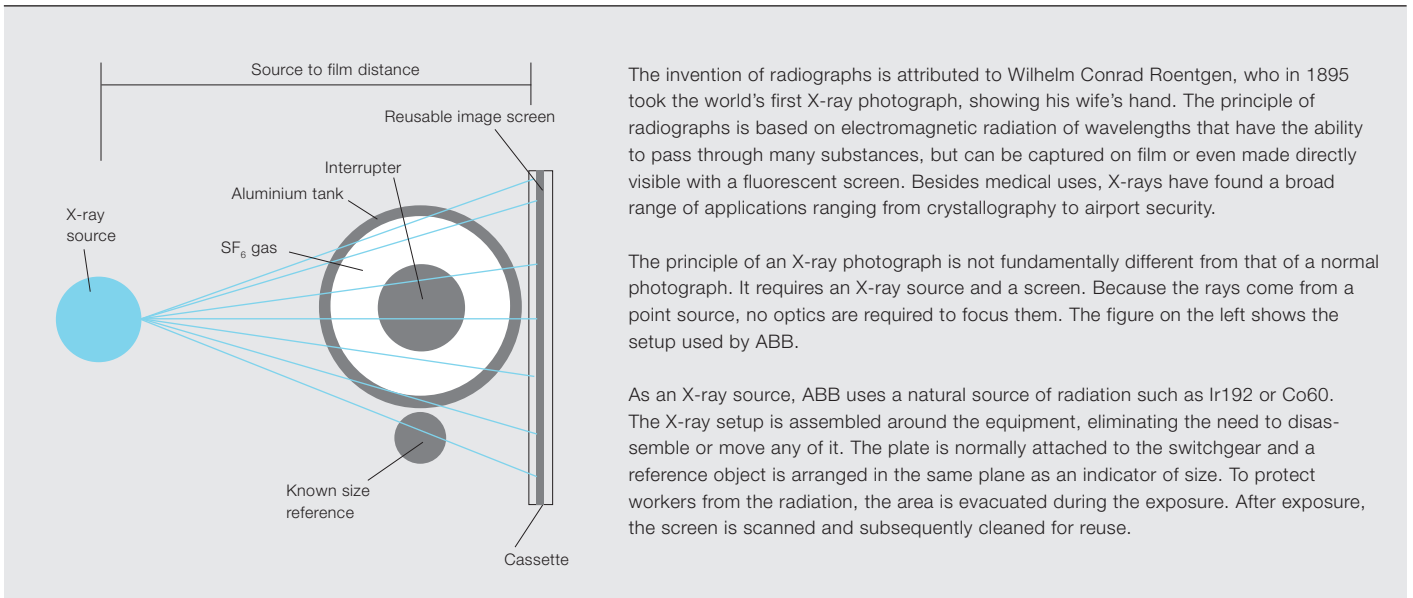

The invention of radiographs is attributed to Wilhelm Conrad Roentgen, who in 1895 took the world's first X-ray photograph, showing his wife's hand. The principle of radiographs is based on electromagnetic radiation of wavelengths that have the ability to pass through many substances, but can be captured on film or even made directly visible with a fluorescent screen. Besides medical uses, X-rays have found a broad range of applications ranging from crystallography to airport security.

The principle of an X-ray photograph is not fundamentally different from that of a normal photograph. It requires an X-ray source and a screen. Because the rays come from a point source, no optics are required to focus them. The figure on the left shows the setup used by ABB.

As an X-ray source, ABB uses a natural source of radiation such as Ir192 or Co60. The X-ray setup is assembled around the equipment, eliminating the need to disassemble or move any of it. The plate is normally attached to the switchgear and a reference object is arranged in the same plane as an indicator of size. To protect workers from the radiation, the area is evacuated during the exposure. After exposure, the screen is scanned and subsequently cleaned for reuse.

Inspecting switchgear the traditional way is not a simple matter. First of all, downtime has to be planned and coordinated. Before humans can approach the equipment, it must be disconnected and earthed. Breakers filled with SF₆ have to be degassed (and because SF₆ is a potent greenhouse gas, it should not be released into the atmosphere but collected and recycled). Then begins the actual dismantling and subsequent reassembly. This phase brings with it the risk that human errors can introduce defects that were not previously present. Parts can be lost, damaged or incorrectly fitted and debris can enter the equipment. Disassembly for inspection is time consuming and costly, and not always effective.

In view of the importance of switchgear in the delivery chain of electrical energy, utilities cannot afford not to inspect their switchgear regularly. An unexpected malfunction can cause blackouts and thus lost productivity and damage to the economy. At the same time, in order to plan maintenance and replacement effectively, knowledge of the condition of switchgear is vital.

Enter radiography. With radiographic inspection, ABB can see inside equipment without having to disassemble it. Just as with the manual inspection described above, the switchgear must be taken out of service, disconnected

and earthed. But the subsequent steps and overall downtime are replaced by the far simpler and much less invasive setting up of radiography equipment → 1. Time savings achieved means downtime is reduced from days to hours → 2.

Combined with operational diagnostics (precise measurement response times to infer the degree of wear of contacts), radiography can provide a low-cost yet effective way of obtaining detailed information on the condition of equipment and for predicting the remaining number of operating cycles before intervention is required.

A comparison between radiographic images and a diagram are shown in → 3. Examples of the level of detail such images can provide is shown in → 4. Experts can use such images to measure parts that are subject to wear. An "in spec" nozzle is compared with an "out of spec" one in → 5.

Besides problems associated to wear, radiography can also reveal manufacturing defects. In → 6, a detached screw can be seen, and in → 7, a bolt is incorrectly inserted.

Case study: Call Henry Inc. and NASA

Call Henry Inc. is the high-voltage on-site service contractor at the NASA Glenn Research Center in Cleveland, Ohio in the United States. The center

With radiographic inspection, ABB can see inside equipment without having to disassemble it

Title picture

Looking inside a breaker with radiography

2 Typical time savings achieved with radiography

Circuit breaker type	Outage times	
	Traditional invasive internal inspection	Radiography
38 – 145 kV	2 days	2 hours
242 kV	3 days	3 hours
362 kV	4 days	3 hours
550 kV	5 days	4 hours

3 Comparison of radiographic images and a diagram of a 38/72 PM interrupter

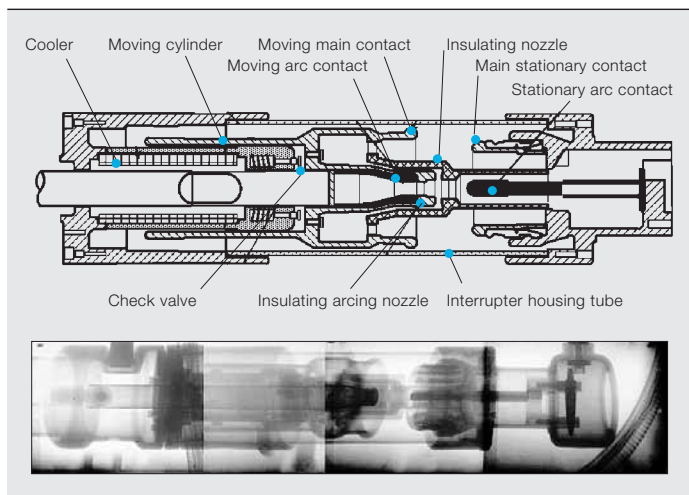

4 Examples of details revealed by radiography



5 Comparing a “good” and a “bad” nozzle

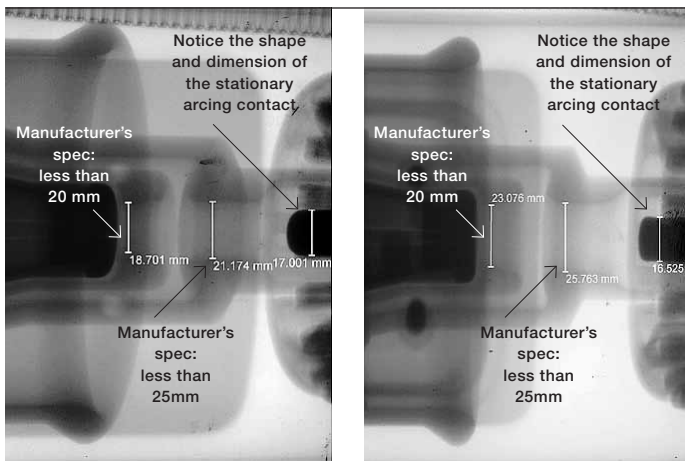

5a Nozzle in spec

5b Nozzle out of spec

Downtime is reduced from days to hours.

leads NASA's R&D in aeropropulsion, and specializes in turbomachinery, power propulsion and communications, while also leading research in the microgravity science disciplines of fluid physics, combustion science and the fields of microgravity acceleration measurement. The reliability of the power supply is vital for the center's operations. A review of the switchgear revealed that many of the center's circuit breakers were 10 to 14 years old, with one having completed 2,700 operations during its lifetime.

In February 2006, Call Henry Inc. contacted ABB on behalf of the research facility regarding the health of 26 ABB type 38PM40-20 SF₆-filled circuit breakers. With regard to reducing costs and downtime, it was decided to conduct external diagnostics testing and radiographic inspection. As a result of these tests, of the 26 breakers radiographed:

- One required entry to remediate a hardware problem.
- Seven required reduction of the SF₆ gas moisture content.

6 Detached screw

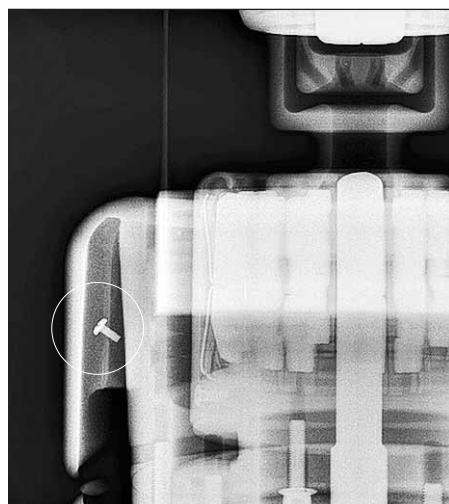

- 19 were spared entry and intrusive maintenance.

Overall, 38 man-days of intensive, internal inspections were saved. After performing the external diagnostic testing and resulting maintenance, NASA's fleet was restored to reliable operating status for less than 50 percent of the cost of traditional maintenance.

7 Incorrectly inserted bolt (note gap between disk and casing)

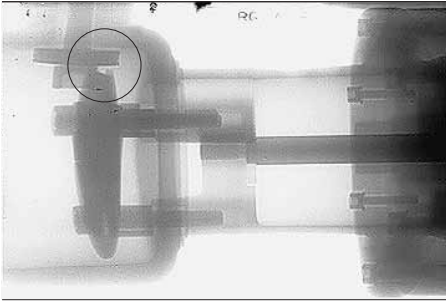

7a An area of concern

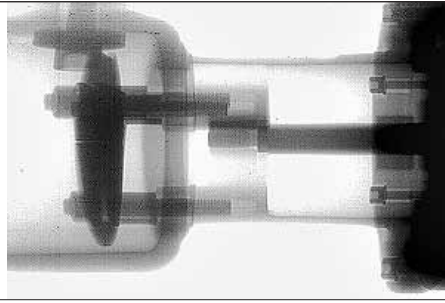

7b Correct bolt

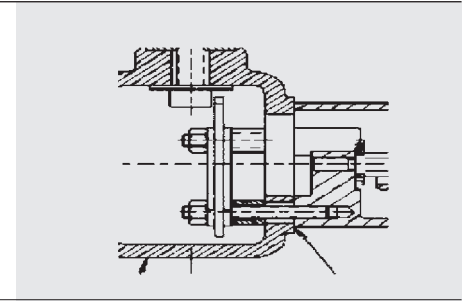

7c Reference drawing

Case study: Pacific Northwest

ABB was asked to perform radiographic inspections of eight ABB breakers for a Pacific Northwest utility in the fall of 2006. Shortly before the inspection, the utility had removed a Westinghouse 262SFA breaker from service. An inspec-

respect to traditional internal inspections.

Radiography is the tool

These and other examples show that radiographic inspection saves both time and money, both by reducing the amount

of work needing to be done when compared with traditional invasive inspection, and in terms of disruption and downtime for the customer. ABB can perform radiography on both equipment of its own manufacture

ABB can perform radiography on both equipment of its own manufacture and on the products of other and legacy manufacturers.

tion of the removed breaker revealed that the orifice on one contact was broken and that the guide rings from four others had become detached and were lying at the bottom of the tank. This situation posed the possibility of a catastrophic circuit breaker failure. Increasing the risk was the fact that the broken part turned out not to be an OEM¹ component but a reverse-engineered non-OEM one (ABB took over the transmission and distribution activities of Westinghouse in 1989 and continues to supply OEM parts).

and on the products of other and legacy manufacturers, and has the expertise to evaluate the photographs and provide service advice on the basis of this.

Five further breakers of the same design were thus inspected by ABB using radiography. Based on the findings and a review by a Westinghouse expert, it was determined that one of these breakers had no less than three broken orifices. One phase was missing both orifices and one phase was missing one. If this breaker were called on to perform a full-fault interruption, a failure would be likely. The other breakers were found not to be in need of immediate repair. This operation saved the customer \$60,000 with

Jerry Michaelson

ABB High Voltage Products
Nashville, TN, United States
jerry.michaelson@us.abb.com

Andreas Moglestue

ABB Review
Zurich, Switzerland
andreas.moglestue@ch.abb.com

Footnote

¹ OEM: Original equipment manufacturer



Always in touch

Adapting mobile devices to industrial applications

FREDRIK ALFREDSSON, JONAS BRONMARK, PETTER DAHLSTEDT, MAGNUS LARSON, ELINA VARTIAINEN – Mobile devices have great potential to increase the efficiency, productivity and satisfaction of plant personnel in industrial settings: People could work more independently; there could be fewer errors as personnel access information on their mobile devices rather than relying on other people or one's own memory; systems could be updated on the spot; and decision makers could be contacted directly anytime. Mobility could considerably increase the efficiency of field workers as they could

access real-time information away from their work stations or control rooms, enabling greater independence. And yet, despite the obvious gains to be had, mobile devices in industrial settings are not being utilized to their fullest. But ABB is working to change that. Its researchers have been identifying the challenges of using mobile devices in traditional production environments as well as identifying the needs of personnel in those settings. ABB is defining mobile device concepts that will help empower plant personnel.



Today, mobile devices are an essential part of people's daily activities, enabling them to keep in contact through calling, texting, emailing and social media. Mobile devices are also used to create media (including photos and videos) that can be shared with others. Moreover mobile devices are more than just communication devices: They can be used as a music player, a navigation device or a gaming platform, enabling a very powerful combination of technology that can be leveraged for industrial automation. The interaction techniques people use to control mobile devices (for example, touch, voice and gestures) have also evolved at a fast pace during recent years. For example, the introduction of well-designed touch-enabled devices changed the smartphone market completely, and the voice recognition (for example, Siri on the iPhone) and gesture recognition are finally at an acceptable level. These possibilities enable efficient interaction between the user and the mobile device even in situations where hand/eye interaction is not possible.

Challenges for mobile devices

The challenges of introducing mobile devices in industrial environments include network capability, current work practices, IT infrastructure, environment and safety equipment.

Network capability

An industrial plant may not have network infrastructure for mobile connectivity. This might be quite obvious in an underground mine, where the rock makes it very difficult to build a network that would provide good signal strength. Yet open-pit mines might not have good mobile network coverage either since they are often located in sparsely populated remote areas, which therefore have no need for commercial or proprietary mobile networks.

Current work practices

In many plants radio phones (ie, walkie-talkies) are still an important means of communication between workers. Factories are often divided into many areas that use different radio frequencies for communication to prevent information overload. In some factories workers carry both a mobile device and a radio phone, as the mobile device has not

A powerful combination of technology can be leveraged for industrial automation.

been able to replace the functionality that radio offers.

Title picture

Mobile devices like the Apple iPad are being used efficiently in industrial settings.



IT infrastructure

Industrial IT systems usually contain a lot of legacy software as they have been developed over several decades, and it might be difficult to integrate mobile devices to the existing process systems.

There is no use
for mobile solutions
if the information
cannot be
accessed anytime,
anywhere.

For example, the mobile solutions introduced by the customers might not be specifically designed for mobile devices but rather copied from a desktop environment.

Industrial processes also require extremely secure IT systems, which external persons are not able to access. Companies are concerned about utilizing mobile devices as they could introduce more complexity and risks into their IT systems. The IT department might value system security more than providing mobile solutions that could improve efficiency. Understanding this tradeoff is crucial when designing mobile solutions for industrial automation.

Environment

The multitude of different industrial environments also affects mobile device use. Some have impurities such as dust or dirt which can affect the touch abilities. Other environments might have large temperature variations affecting the battery function and possibly making the mobile device work slower with longer response times. Others might have humidity. Light conditions can also differ, thus impacting the color scheme and lighting in the device to achieve the best contrast.

Safety equipment

Industrial environments require personnel to wear protective gear. The type of gear can vary based on the safety level of the process, but in general, safety boots, vests, helmets, gloves, ear protection and safety glasses are commonly used. Often protective gear is mandatory in certain areas; for example, when moving in tunnels inside a mine or walking around a plant. Yet today's workers spend less time in dangerous areas, as they more often stay in control rooms or other office locations. Therefore, safety equipment is becoming less of a challenge in certain areas.

Assessing needs

ABB has identified specific needs for mobile devices to be used in industrial environments. Understanding these needs is essential when designing mobile solutions to create more efficient operators and field workers.



Light conditions can differ, impacting the color scheme and lighting used in the device to achieve the best contrast.

Through its research, ABB has discovered that rugged mobile devices are not wanted in locations where spark-free equipment is not a requirement (as, for example, in oil or gas platforms). Users prefer to replace broken or lost devices with new ones rather than pay extra for rugged options. Users want well-designed backup solutions that will keep the device content safe in case of an accident. The backup solutions would automatically save the content of the mobile device to a secure server to prevent information from getting lost in case of an accident.

And of course, security must be very high since any break-in to the system could be disastrous. Yet the level of security should not affect the availability of the system: There is no use for mobile solutions if the information cannot be accessed anytime, anywhere.

Another important criteria is that the mobile device should fit into a pocket; otherwise, the device might stay on the work desk and not be carried along during assignments at the plant.

The ability to type with a full keyboard is not considered an issue since the mobile device is not meant to replace a desktop

computer – it is just a tool when a field worker is on the move. ABB has installed Extended Automation System 800xA workstations in plants for workers to access the process automation system remotely. These stations have a keyboard and a big screen and can be used when the capabilities of a mobile device are not enough → 1-2. Learning to cope with certain limitations of smartphones – for example, the need to charge the phone daily – is also not considered an

Rugged mobile devices are not wanted in locations where spark-free equipment is not a requirement.

issue since the phone could be charged between one's shifts together with other equipment that also needs to be charged – eg, lamps. Thus, special devices with extended battery durability might not be necessary.

Current mobile devices that have been specifically designed for industrial environments do not include the latest available interaction technologies such as multitasking or multitouch, nor are they equipped with sensors for measuring the orientation (gyro, accelerometer), proximity of other objects, and light conditions. However, the latest smartphones

Three of ABB's customers have introduced a mobile solution that utilizes the remote desktop capability of System 800xA: Boliden in Gällivare, Tarkett in Ronneby and Alcro Beckers in Nykvarn. The Boliden mine was using an Android app on a smartphone and Tarkett and Alcro Beckers had tablet computers. All of the mobile solutions used the remote desktop to access System 800xA in a similar way as for PC clients. Therefore, the mobile solutions in use were not specifically designed for mobile devices with smaller screens and touch user interfaces but were directly transferred from the PC solutions without significant rework. The customers commented the benefits of their mobile solutions as follows:

"Through the mobile client we can access all the systems: we can control processes, produce electrical drawings and functional descriptions, and access the maintenance system. It is very valuable to be able to be at the process site and troubleshoot without the help from the control room. Earlier without the phone we had to work in pairs: the other one was in the control room and checking the screens and the other one was at the site."

– Mikael Burck, Electrical Department
Manager at Boliden Aitik

"It is an enormous advantage for the maintenance engineer to have all relevant data easily accessible. The tablet computer with remote desktop connection to our System 800xA makes his work much more effective as he now can operate the process, view real time values and historical data during the trouble shooting."

– Ted Evaldsson, Electrical Department
Manager at Tarkett

"I use 800xA from my iPad through the remote desktop to start new sets of batches, to monitor the process and to make adjustments to the process. It has proven to be a really efficient and accurate tool as now I can observe the tank and its content while I am making the adjustments."

– Mats Johansson, Process operator at
Alcro Beckers

The main advantage of a mobile device in an industrial setting is the real-time access to all information independent of the workers location.

in consumer markets offer these capabilities and a superior user experience. Workers in industrial settings have the same expectations of mobile devices when used as a work tool.

The main advantage of a mobile device in an industrial setting is the real-time access to all information independent of the workers' location. The information includes the process data as well as manuals, blueprints, and descriptions. Up-to-date information is vital for accessing process information. Today, this is accomplished by communicating via radio or phone with the operator in the control room → 3.

For a mobile solution to work, it is important that everyone is included in mobile communication. All personnel should have a mobile device in order to be reachable. Otherwise, other communication methods are needed, which in turn add complexity to the communication. In an ideal case, people could contact anyone at the plant according to, for example their availability, responsibility area or expertise without needing to know the actual phone number. The communication method (for example, phone or video call, text messages, or chatting) could also be chosen according to the work task and availability of participants. This could minimize the operators being overloaded as they could answer some of the questions asynchronously. Mobile devices would also enable private communication, which is not possible with radio phones.

At times personnel in industrial settings use their work or even private mobile devices to take pictures or videos of issues encountered for documentation or to consult with their colleagues. However, they do not have any support for this task from the system or tools provided by their employer. Therefore, industrial mobile devices need to make it possible to collect and share information about the status of the industrial process more directly.

Application development

The rapid development of Web and mobile applications is very different from the traditional release cycle normally used for industrial systems. Mobile applications have adopted a release cycle of weeks and months, adding new functionality and features as they are updated. The mobile app Angry Birds, for example, has constantly been adding more levels and new characters into the gameplay since it was released in late 2009. Similarly the Facebook application for iOS has also constantly been adding functionality over time instead of releasing a version that does every requested feature from day one.

Such a method for software development (ie, adding functionality in small but frequent installments) is necessary in the mobile domain as the hardware and software is shifting so rapidly. That is, the top-of-the-line hardware today will be considered old and replaced by something else tomorrow. These quick software release cycles are something that

the industrial sector will have to adapt to by releasing updates as frequently as any other apps for the mobile devices instead of releasing “super versions” that include every requested feature but with the price of a very long development phase.

Furthermore, with a shift toward quick development cycles it is possible to develop and release software for the industry that solves the most critical use cases, where mobile solutions will make a huge impact. Continuous updates to the industry applications will then improve and add requested features. Also, “rapid prototyping” and mobile app development on mobile devices is inexpensive today, which makes the smartphone platforms attractive for industrial domains as well.

What lies ahead

The continuous progress in mobile technologies related to user experience and interaction techniques raises the need to allow existing human-machine interfaces (HMIs) to evolve so that personnel can use these techniques when interacting with ABB products. Future HMIs should utilize the best parts of these new inventions (including depth-sensing, gestures, voice control and new display technologies) and enable users to interact with systems more efficiently, and safely.

ABB research shows that with custom-made apps for well understood scenarios and use cases, mobile device usage in industrial automation can be taken to a completely new level. New developments such as augmented reality, pico projectors and sensors for detecting the environment can make mobile devices even more powerful in several ways. Augmented reality shows a live view of the reality through, for example, a camera view of a mobile device. The view is then augmented by computer-generated content (eg, graphics). Augmented reality could benefit, for example, maintenance engineers to show more equipment-related information. For instance, the system could visualize important infor-

mation related to a device (eg, the water level in a tank).

Pico projectors are small, handheld projectors that can project full-size images onto any surface. When these are attached to mobile devices (some mobile devices already include one, for example, Samsung Beam), any surface can be used as a display. Then, a maintenance engineer could use his pico projector to project, for example, instructions related to maintenance work directly on top of the device that needs repair.

Mobile devices already include sensors such as a gyroscope and accelerometer to detect the orientation of the device. In the future, mobile devices will probably include more sensors such as infrared cameras or smell detectors to record data about the environment. This information could be used to check if there are abnormal gases in the air or if some equipment has overheated. The gyro and accelerometer could be used to detect where the maintenance engineer is

Continuous updates to the industry applications will then improve and add requested features.

pointing, and identify the device in question to give him more information related to the device.

ABB continues to look toward the future, to analyze the impact of emerging technologies, and explore efficient utilization and the reasonable combination of existing and emerging technologies related to mobile device enhancement.

Fredrik Alfredsson

Jonas Bronmark

Elina Vartiainen

Magnus Larsson

ABB Corporate Research

Västerås, Sweden

fredrik.alfredsson@se.abb.com

jonas.bronmark@se.abb.com

elina.vartiainen@se.abb.com

magnus.larsson@se.abb.com

Petter Dahlstedt

ABB Process Automation, Control Technologies

Västerås, Sweden

petter.dahlstedt@se.abb.com





Protection from cyber threats

Can utilities and industries afford a cyber security breach?

PATRIK BOO – The intensity of cyber attacks on IT systems increases with every passing day. Worryingly, growing connectivity and hacker sophistication are making IT systems more vulnerable to such intrusions. Targets that have, until recently, remained relatively unscathed, or at least unnoticed, are the systems that oversee industry processes around the world. The highly sophisticated attack by the Stuxnet malware and other control system incidents have raised general awareness of control system vulnerability. If a control system is attacked, or even unintentionally compromised, the result could include regulatory violations, equipment damage, production loss, harm to the environment, or public and employee endangerment. In response to the potential threat and consequent customer demand, ABB has created Cyber Security Fingerprint, a noninvasive service that significantly helps to reduce a control system's risk of attack.

Title picture

Today's "wired" environment presents cyber security challenges for owners of control systems. ABB's Cyber Security Fingerprint provides a comprehensive solution.

As cyber crime costs are two to three times higher than the cost of safeguards, proactively investing in cyber security makes good sense.

Today's control systems are more vulnerable to cyber threats than ever due to increased interconnectivity, cloud computing and sharpened hacker skills. Whereas enterprise IT was always a favored hacking target, hackers' attention is now increasingly turning to control systems. Adding further urgency to the situation is the fact that emerging economies are creating a proliferation of control systems.

Attacks on control systems can cause havoc:

- In a sewage treatment plant in Australia, a disgruntled former contractor gained access to the plant's control system and flooded the surrounding area with millions of liters of untreated sewage, contaminating parks, rivers and the grounds of a hotel.
- In Australia, the "Sasser" worm infected the signaling and control system of RailCorp, halting all trains for the day and stranding 300,000 Sydney commuters.
- The control systems of water utilities in the US states Illinois and Texas were allegedly hacked. In Illinois, a water pump was repeatedly turned on and off until it burned out [1]. Shortly afterwards, a hacker posted screen-

shots of himself logged into the control system of a Texan water utility to demonstrate how easily the Illinois control system – or any other – can be hacked.

- The safety monitoring system of the Davis-Besse nuclear power plant in Ohio was infected with the "Slammer" worm in January 2003, disabling it for five hours. The worm bypassed the plant's firewalls via a contractor's laptop computer that was connected to the power plant's network. Fortunately, the nuclear plant was shut down for scheduled maintenance at the time. However, the worm raced through the Internet and caused a denial of service on some Internet hosts, dramatically slowing general Internet traffic. In addition to the nuclear plant, the worm infected almost 75,000 other victims within 10 minutes, including a power company control system via a virtual private network (VPN), a petroleum plant control system via a laptop, and a paper machine operator station via a dial-up modem. It is estimated to have caused more than \$1 billion in damage.

A 2011 study by the Ponemon Institute on cyber crime in large US-based multinational organizations quantifies the financial impact of cyber attacks and highlights how they can seriously damage an organization's bottom line [2]. The study found that the median cost to a company of cyber attacks is \$5.9 million per year, though this figure ranged from \$1.5 million to \$36 million. These costs are not expected to decline. The \$5.9 million figure represents an increase of 56 percent from 2010.

According to the Ponemon report, a benchmark sample of 50 organizations experienced 72 discernible and successful cyber attacks per week in 2011, which translates to 1.4 successful attacks per benchmarked organization each week. This represents a 44 percent increase in successful attacks from the previous year. Virtually all organizations experienced attacks relating to viruses, worms and/or trojans over the four-week benchmarking period → 1. Interestingly, these malicious attacks represent only around a quarter of cyber security incidents – the remainder are caused by negligence, malware or IT malfunctions.

1 The types of attack methods experienced by companies participating in the Ponemon benchmark [2]

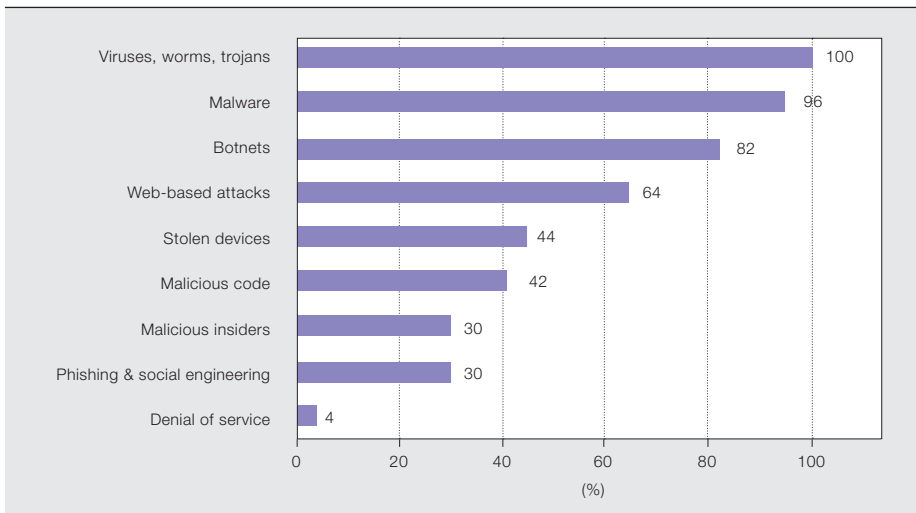

Procedures and protocols: qualitative analysis that indicates how well-written instructions and policies secure the organization.

Cyber attacks are common, expensive and disruptive. In a survey released in 2011 of 200 IT executives in charge of oil, gas, and water utilities in 14 countries, 80 percent of them reported that they had experienced large-scale denial-of-service attacks [3]. Although mostly related to enterprise IT, these statistics indicate that any company without a

the “Flame” virus, the most sophisticated malicious code ever seen.

Such highly dangerous threats to control systems have caught the eye of governments, which are making moves to regulate cyber security should businesses not do so. While not necessarily bad, government-imposed regulations may

miss the mark or add unnecessary cost. Moreover, a regulation-driven security approach is a poor alternative to a risk-driven one. Therefore, businesses must show they are correctly and proactively addressing cyber security, even though a 2012

Today’s control systems are more vulnerable to cyber threats than ever before due to increased interconnectivity, cloud computing and sharpened hacker skills.

well-developed cyber security strategy is risking too much in believing they will not be attacked. As cyber crime costs are, at least, two to three times higher than the cost of safeguards, proactively investing in cyber security makes good sense.

Cyber attacks – the response

Hackers are becoming more creative and capable, and the number of such individuals and organized groups is rising, often causing damage that costs millions, if not billions, of dollars. Since Stuxnet, the malware that infected and crippled Iran’s Natanz nuclear-fuel processing facility in 2010, utilities and industrial plants have been on the alert. Recently, tension has been heightened by the appearance of

Bloomberg Government study concluded that utilities, banks and other infrastructure operators may need to spend up to nine times as much as present on better security [4].

The protection challenge

Formerly, control systems were isolated from the rest of a plant’s information systems. Now, business demands a much more integrated approach. Utilities and industries count on this unprecedented information sharing to gain detailed visibility into the business and to facilitate better decision-making.

2 The ABB Cyber Security Fingerprint follows ABB's proven three-step advanced services methodology.

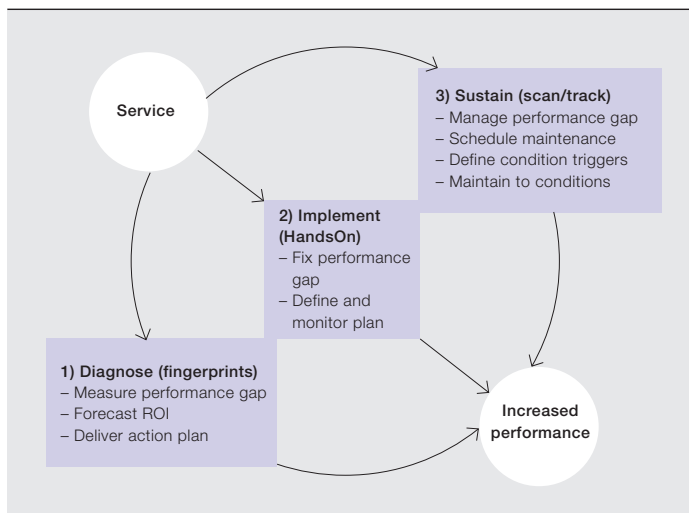

3 Multiple layers of protection significantly reduce risk of attack

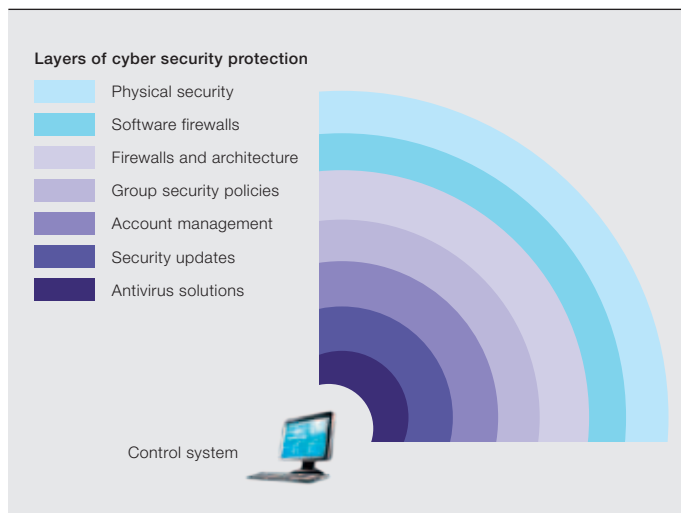

To assist customers against cyber threats, ABB created the Cyber Security Fingerprint.

Further complicating the situation is the fact that control systems tend to have long lives, up to 15 to 20 years or more. Therefore, defenses against cyber attacks may be outdated or even nonexistent. In addition, many systems include small processing devices that perform

described in this article, security experts are very concerned about the vulnerability of control systems to cyber attack.

Cyber Security Fingerprint

To help customers resist cyber threats, ABB created Cyber Security Fingerprint, a

The process of identifying strengths and weaknesses, based on data gathered from critical systems and key personnel, and comparing them with industry best practices, is the backbone of ABB Cyber Security Fingerprint.

noninvasive service that can be applied to most control systems running current versions of Microsoft's Windows operating system. It follows ABB's proven three-step advanced services methodology → 2. This methodology helps control system owners protect their investments and businesses by identify-

specific tasks and that are simply not equipped to run antivirus software or protective firewalls.

ing vulnerabilities and outlining how best to mitigate risk:

Furthermore, an attack on a control system can have very different consequences from one on a business system. Instead of informational and financial loss, the impact could violate regulatory requirements, damage equipment, result in production loss, harm the environment, or threaten public and employee safety.

- 1) Diagnose: A current-state evaluation and comparison with best equipment and industry practices and standards is the first step in developing a strategy that will mitigate the risk from cyber security threats to control systems. The intention of this exercise is to identify vulnerable areas and make recommendations to address them.
- 2) Implement: Based on the vulnerabilities identified in step one, the physical and virtual elements of the control system are secured with the appropriate security settings, policies and procedures. This can be done by following

4 ABB examines three key components of a plant's control system to determine key performance indicators.

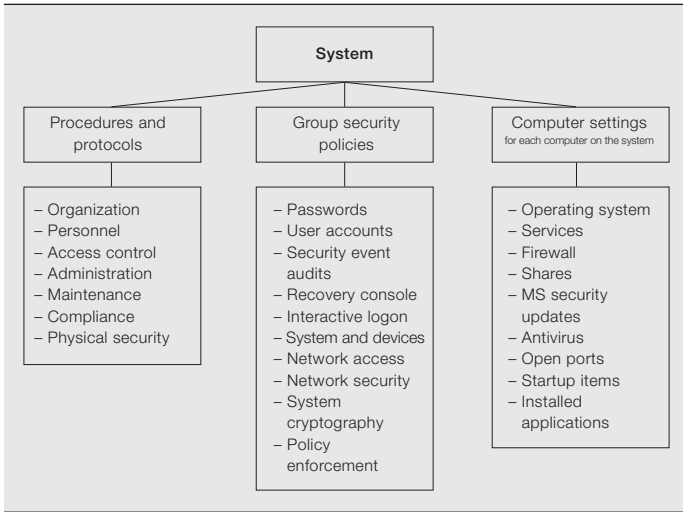

5 The report shows the relative risk to the system based on the assessed parts. Areas with less coloring have lower risk than those with more.

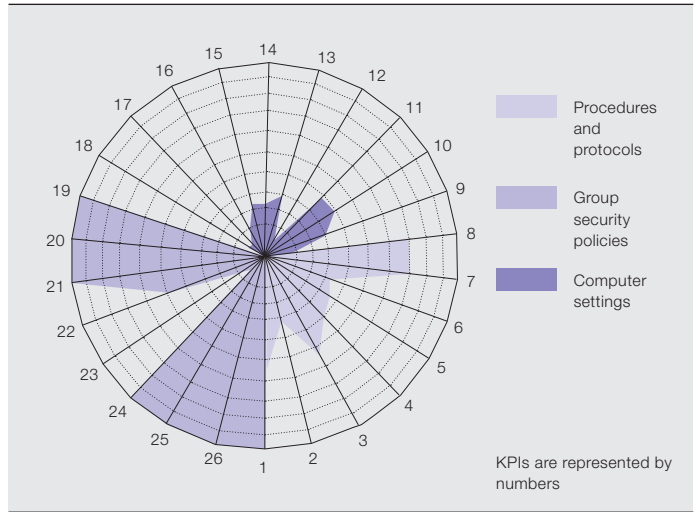

the recommendations, such as creating protocols for password settings, outlined in the fingerprint report.

- 3) Sustain: Ongoing condition monitoring, or at least periodic checking, is necessary to sustain a secure system in a rapidly evolving environment.

This process of identifying strengths and weaknesses, based on data gathered

customer's network and to collect profile and setting information. This process tightly follows ABB's security policies and procedures.

This data is coupled with information gathered from structured interviews with key plant personnel to compare system and plant security status with best practices and standards for the industry, such as the ISO/IEC 27000¹ series, NERC-CIP² and ISA-62443 (ISA-99)³. ABB's Security Analyzer is then used to generate key performance indicators (KPIs), which highlight strengths and weaknesses

ABB's advanced service methodology helps control system owners protect their investments by identifying vulnerabilities and mitigating risk.

from critical systems and key personnel, and comparing them with industry best practices, is the backbone of ABB Cyber Security Fingerprint. ABB's approach follows the "defense in depth" principle, which means the fingerprint checks if a control system has the multiple layers of protection required to significantly reduce the risk of attack → 3.

To complete the first step of the fingerprint, an ABB field engineer uses ABB's proprietary, high-speed, software-based data collection tool, Security Logger, to collect information and system settings from the control system and computers on the plant network. A temporary executable file is loaded to search all connected computers and endpoints on the

of the assessed control system cyber security → 4. ABB determines KPIs for three key areas:

- Procedures and protocols: qualitative analysis that indicates how well-written instructions and policies secure the organization
- Group security policies: policies implemented on the system, enforced from a central server or implemented on individual computers
- Computer settings: settings and applications that reside on individual computers in the system

Based on the information gathered and the calculated KPIs, a diagram is generated that identifies the system's cyber security risk → 5. While minimal color-

Footnotes

- 1 The ISO/IEC 27000 series (also known as the ISMS Family of Standards) comprises information security standards published jointly by the International Organization for Standardization (ISO) and the International Electrotechnical Commission (IEC).
- 2 NERC is an international, independent, not-for-profit organization whose mission is to ensure the reliability of the bulk power system in North America. NERC-CIP specifically applies to critical infrastructure protection (CIP).
- 3 ISA99 covers industrial automation and control systems whose compromise could result in any or all of the following situations: endangerment of public or employee safety; loss of public confidence; violation of regulatory requirements; loss of proprietary or confidential information; economic loss; and impact on national security.

6 Examples of findings

Subject	Description	Recommendation
Security policy	It is crucial to have a cyber security policy. The policy clearly describes what is and what is not allowed and how to react to different situations. The process of writing the policy is important because it forces the organization to discuss all aspects of cyber security.	Get managers to agree on the importance of a cyber security policy. Designate a cyber security team to write and maintain it.
Password history size	By setting a password history size, users can choose how often old passwords can be reused. Users are discouraged from cycling through a common set of passwords.	Set the password history size value greater than or equal to 13 passwords.
Windows Server 2003 SP1	Windows Server 2003 service pack 1 was introduced March 30, 2005 and the official support ended April 14, 2009.	Upgrade all server software to the latest version. NOTE: Upgrading the operating system may lead to the need to upgrade the ABB software as well. ABB's Automation Sentinel program will enable subscribers to take advantage of new ABB software and updates.

Once recommendations have been implemented, the process and tools installed enable periodic re-evaluation to measure and sustain the level of security, essential at a time when cyber attacks are evolving daily.

ation in this diagram indicates a lower risk, it does not mean the system is safe from attack. It does, however, indicate that good basic cyber security is in place for the system.

The report also includes detailed findings for each section and recommendations on how to improve vulnerable areas → 6. ABB is able to assist in implementing these. The recommendations include physical considerations, management of the entire infrastructure, policies and procedures, and governance and accountability across the organization.

Once the recommendations from the fingerprint have been implemented, the process and tools installed enable periodic re-evaluation to measure and sustain the level of security over the lifetime of the control system. This is essential at a time when cyber attacks are evolving daily.

It is important to note that the Cyber Security Fingerprint is an indicator of a system's security status at a given time. Even if all recommendations are followed, the fingerprint does not guarantee a 100 percent secure control system. No cyber security check ever can.

Comprehensive protection

The ABB Cyber Security Fingerprint is a noninvasive service that can be applied to most control systems running a current version of the Microsoft Windows operating system. It utilizes data collection, industry standards, best practices, robust technology and system security expertise to help companies protect valuable as-

sets. Understanding control system cyber security vulnerabilities can enable utilities and industries to define and implement cyber security plans that will:

- Increase plant and community protection
- Reduce potential for system and plant disruption
- Better mitigate risk against a cyber security attack
- Lower the cost of detection, containment and recovery from cyber crimes
- Provide a solid foundation from which to build a sustainable cyber security strategy

Patrik Boo

ABB Process Automation Lifecycle Services
Westerville, OH, United States
patrik.boo@us.abb.com

Further reading

Obermeier, S., Stoeter, S., Schierholz, R., Braendle, M. Cyber security: Protecting critical infrastructure in a changing world. *ABB Review* 3/2012, 64–69.

References

- [1] Ahlers, M. (2011, November 18). Feds investigating Illinois 'pump failure' as possible cyber attack. CNN.com. Retrieved July 10, 2012 from http://articles.cnn.com/2011-11-18/us/us_cyber-attack-investigation_1_cyber-attack-cyber-security-national-cybersecurity?_s=PM:US
- [2] Ponemon Institute. (August 2011). Second annual cost of cyber crime study: Benchmark study of U.S. companies. Traverse City, MI.
- [3] Torrenzano, R., Davis, M. (2011). Digital Assassination. New York; St. Martin's Press.
- [4] Engleman, E., Strohm, C. (2012, January 31). Cybersecurity Disaster Seen in U.S. Survey Citing Spending Gaps. Bloomberg.com. Retrieved July 10, 2012 from <http://www.bloomberg.com/news/2012-01-31/cybersecurity-disaster-seen-in-u-s-survey-citing-spending-gaps.html>



Sustainable energy reductions

ABB's industrial energy efficiency solutions are delivering accelerated energy savings to industry

CHRIS STUBBS – Energy efficiency and its concomitant environmental implications are a concern across the global industrial base. Substantial potential for improvement exists; however, many companies have yet to incorporate energy-saving technologies into their operations. ABB has designed a new commercial approach to improving energy efficiency in industry, helping customers to use electrical power effectively

and to increase industrial productivity in a sustainable way. Using this approach ABB has identified energy savings of 5 to 20 percent across a wide range of industries and utilities including compressed air and gases, refrigeration and HVAC, cooling water systems, life sciences, iron and steel, minerals and mining, pulp and paper, power generation, food and beverage and industrial chemicals.

By leveraging ABB's deep domain knowledge in power and automation customers can truly procure energy savings.

1 ABB's Extended Automation System 800xA increases energy efficiency, asset utilization, energy savings and operator effectiveness



The case for energy efficiency improvements across large parts of industry is well known. Government agencies and public and private research has shown that there are substantial energy saving possibilities in most industrial sectors and in most regions of the world. And yet, in spite of the commercial attractiveness of these energy saving opportunities, companies are not commissioning energy saving projects and therefore are not achieving their potential to reduce energy consumption. ABB has considered the real barriers to implementation to design viable solutions to overcome many of the obstacles that exist.

Notably, even in regions where the reduction of energy consumption and carbon emissions have been high on the agenda for many years (such as in Northern Europe), many organizations have yet to move on from the initial identification of problems –referred to as an energy audit. Governments and utility companies have funded the provision of energy audits as a means of priming the pump and promoting energy savings but the follow-on action has not been forthcoming. Why is this?

Risk aversion to the unfamiliar

In a petrochemical plant, for example, engineers are intimately familiar with the core process technology and its relevant machinery. Those engineers are highly competent at understanding how small changes to process equipment, settings and conditions will affect plant reliability, product quality, consistency and output.

The technology already exists to deliver substantial improvements in industrial energy efficiency across most sectors.

The process to realizing most business improvements is sequential – recognizing the need for action, identifying the problems, delineating the improvement measures, and designing and implementing the detailed solutions. Only then will an organization realize, in this case, energy savings.

They are confident, thanks to years of experience, of making modifications to their core process plant and equally confident and accurate in predicting the outcome of those modifications. But a similar level of confidence does not exist

Title picture

Combined cycle power plants like this one can benefit from ABB's industrial energy efficiency solutions.



around, for example, the on-site boiler, steam and power generation systems, the cooling water systems, the fuel gas systems and other noncore utility systems. Consequently, while the core process is operated in a high state of “tune”, the utility systems are often running almost the same as when they were first commissioned 20 or 30 years ago. Furthermore, historically there was very little attention paid to utility process performance and there is very little metering to enable engineers and operators to truly monitor utility system performance.

Disaggregated prize

Energy savings, while significant in the aggregate, are rarely concentrated in a few discrete projects, improvement measures or locations in a complex plant. The energy saving prize is “disaggregated” – spread across 50, 100 or more discrete interventions. Complex process plants are highly asset intensive and such organizations frequently have comprehensive capital project processes to take ideas through a front-end-loaded screening process and through a highly controlled project execution process. The disaggregated nature of energy saving projects leads to a position that the “prize” is not worth the effort of invoking the capital project process 50, 100 or more times. Consequently, energy saving projects are often not implemented.

By accessing ABB’s resources, organizations can systematically overcome the barriers to energy-saving project implementation.

Capability gaps

An effect of the focus on a company’s core technology and manufacturing processes is that there is far less competency in today’s lean manufacturing organizations to support noncore technologies. It is rare to find well-supported energy engineers in most manufacturing organizations. With a lack of energy engineering expertise in-house, the ability of organizations to execute energy saving projects is significantly reduced and, once again, energy saving projects are not implemented.

Biased resource allocation

Businesses, investors and markets are heavily focused on revenue growth. This focus percolates down into two functions within manufacturing businesses. Sales

departments are focused on both market share growth and product price improvement, and production departments are focused on production output growth, to feed the growth of market share – assuming the market size is static or growing. At an engineering level this leads to a focus on plant output and de-bottlenecking and it doesn’t take long for capital to be preferentially allocated to projects that help achieve this outcome, even though there are higher return projects available in cost reduction areas such as energy efficiency. Energy saving projects are, once again, not implemented.

Information flow

It is unusual for changes to be made to businesses or production facilities if it is not possible to demonstrate to stakeholders that the changes promised from the investment have actually been delivered. The phrase “you can’t manage what you can’t measure” seamlessly translates into “we won’t invest if we can’t measure.” Improvement implies that the performance after the investment is better than the performance before the investment and that, in turn, implies that it is possible to measure performance. With poor or nonexistent metering on many utility and energy systems, project opportunities cannot get off first base and don’t get implemented.

But industrial energy savings is not due to lack of technology. In fact, the International Energy Agency published a report in 2009 on energy efficiency in the petrochemical sector, which highlighted that there is a potential to improve energy efficiency by 35% across the global petrochemical sector from the adoption of existing best practice technology and other technologies such as combined heat and power and plastics recycling [1]. The technology already exists to deliver substantial improvements in industrial energy efficiency across most sectors → 1–2. The problem is that it is not being implemented.

Overcoming barriers

ABB’s response to the issues presented above is to offer a wholly different means of implementing energy saving projects in industry. By accessing ABB’s resources, organizations can systematically overcome the barriers to energy saving project implementation.

ABB's program is one of partnership in the delivery of real energy savings for customers.

3 ABB's cpmPlus Energy Manager offers the tools to help reduce energy costs, improve energy efficiency and manage carbon emissions

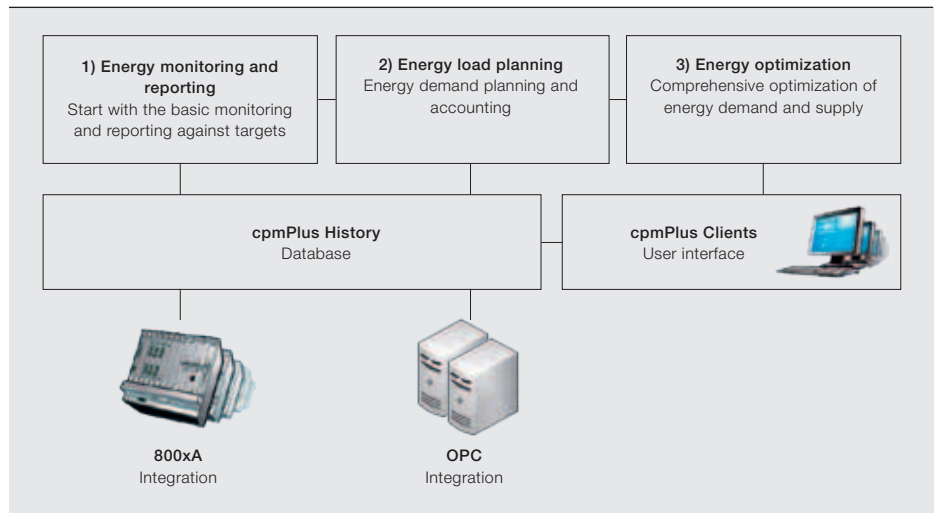

Risk aversion to the unfamiliar

ABB will guarantee the economic outcome of energy projects to assure the customer of a measureable EBITDA (earnings before interest, taxes, depreciation, and amortization) improvement. ABB has the broad technical expertise required to assume the performance risk for the solutions it implements, thereby overcoming issue of risk aversion to the unfamiliar. This includes energy specialists, change management practitioners,

Capability gaps

ABB has deep energy optimization experience across both power and heat systems, as well as demonstrated ability to implement turnkey solutions in industry. As with the solution to the risk aversion barrier, ABB's technical expertise is leveraged to overcome capability gaps in customer organizations. ABB's teams are backed up by appropriate methodologies, tools and software. Its solutions are pragmatic ones, taking into account

the requirements of working in a live operating plant environment.

With a lack of energy engineering expertise inhouse, the ability of organizations to execute energy saving projects is significantly reduced.

Biased resource allocation

Where capital is not available for energy reduction projects ABB will finance energy

project managers, project estimators and planners, process engineers and functional engineering specialists.

Disaggregated prize

ABB will aggregate multiple minor projects and interventions into a major project that creates both visibility and materiality. By bundling individual interventions into a single, larger contract, the customer no longer has to implement a "heavy duty" project process on multiple small projects but can focus on its own production-related projects and leave ABB to worry about the detail of each of the energy-saving interventions.

programs, typically over five years, through shared savings models. ABB's relationships with international financial organizations enables the creation of new financing models for energy saving projects, overcoming the customer's shortage of capital for this type of project.

Information flow

ABB possesses world leading measurement technologies and a sophisticated energy management system, cpmPlus Energy Manager. Measurement and verification (M&V) is a fundamental requirement for all performance-based contracting. ABB's cpmPlus Energy

4 ArcelorMittal Fos-sur-Mer Integrated Steel Mill

<p>ArcelorMittal Fos-sur-Mer Integrated Steel Mill ABB's industrial energy efficiency assessment focused on key plant areas:</p> <ul style="list-style-type: none"> - Basic Oxide Furnace (BOF) plant - Blast furnaces - Cowper stoves - Power plant - Sintering plant - Hot rolling mill <p>Fifty-three individual energy saving opportunities were identified</p> <ul style="list-style-type: none"> - Estimated electrical savings up to € 4.3 million euros (\$ 5.3 million)/year - Additional gas savings of up to 6 million euros (\$ 7.4 million)/year 	<p>Three opportunities were agreed upon for immediate implementation.</p> <ul style="list-style-type: none"> - Zero capital investment opportunities - Energy savings of 120,000 euros (\$149,000)/year; payback < 1 year <p>4 project specifications developed</p> <ul style="list-style-type: none"> - Energy savings of 1.9 million euros (\$2.4 million)/year - Average payback of 1 year <p>"We are very pleased with the results as ABB have defined very clearly where energy can be saved and how to achieve it. The work is really appreciated. It is better than just an audit."</p> <p>- J. Van Lishout, Flat Carbon Europe</p>
---	--

deliberately broad, capturing as much energy saving value as possible for customers, typically leads to the identification of 5 to 20 percent savings of total energy usage.

In developing the site performance contract offer we upgrade our appraisal to "investment grade", drawing on ABB's deep expertise in power and automation.

Having implemented a site performance contract ABB will engineer, procure and construct the improvements agreed with the customer (Implementation). The company commissions the systems and perform baseline and performance tests in accordance with contracted Measurement and Verification (M&V) protocols.

5 ABB's aim is to implement real, significant energy saving projects; without implementation savings are not realized.

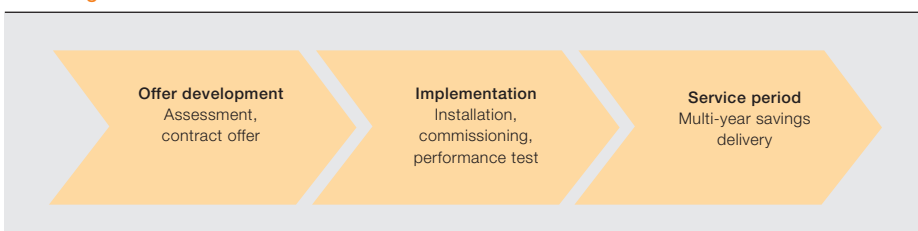

Where ABB's approach differs from most is that, following Implementation, the company remains involved during the service period, when the savings are delivered. The shared savings contract model ensures that long term goals are aligned; ABB and the customer are equally interested in the delivery of real energy savings over the long term.

Manager's base module allows customers and ABB to record and report energy and production data in real-time – providing incontrovertible measurement data upon which to base performance-related remuneration → 3.

Delivering market-leading solutions

ABB's approach to industrial energy efficiency solutions is breaking new ground in industry. By examining the root causes of nonimplementation of the thousands of energy saving ideas already identified by internal and external study teams across thousands of industrial sites, ABB has designed a new commercial approach to improving energy efficiency in industry. The first deliveries of this type of project are due to break ground in the second half of 2012 and will demonstrate the value of ABB's ability to "think outside the box" → 4.

ABB's Energy Performance Contracting Program

ABB's program relies on corporate and general management's support of the overall commercial approach – one of partnership in the delivery of real energy savings for customers. After the conclusion of a Framework Services Agreement for the provision of Energy Services, ABB

Where capital is not available for energy reduction projects ABB will finance energy programs through shared savings models.

Consulting teams will engage with site General Managers following a lead set by a joint ABB-Customer program steering committee.

The approach is flexible and aims to implement a manageable number of projects that will deliver significant energy savings → 5. During the offer development phase we undertake a short (one to two weeks) initial appraisal to produce a portfolio of opportunities. This gives all parties a view of what energy saving opportunities exist, their value and the applicable technologies and solutions required to access them. The appraisal is

Using its expertise, ABB has delivered energy savings across a wide range of industries and utilities. By leveraging ABB's consulting expertise and domain knowledge in power and automation customers can truly procure energy savings.

Chris Stubbs

ABB Consulting
Cheshire, United Kingdom
chris.stubbs@gb.abb.com

Reference

- [1] Saygin, D., Patel, M. K., Tam, C., Gielen, D. J. (2009). Chemical and Petrochemical Sector: Potential of best practice technology and other measures for improving energy efficiency. OECD/IEA. Retrieved July 10, 2012, from http://www.iea.org/papers/2009/chemical_petrochemical_sector.pdf

Texas transformed

Achieving significant savings through a new electricity market management system

KHOSROW MOSLEHI – The state of Texas has long been the center of energy activities in the United States, with Houston being the undisputed oil and gas capital. Less well-known is that Texas is also the largest electricity generating and consuming state by a considerable margin. So it was significant when ERCOT, the electricity reliability council of Texas, selected Ventyx, an ABB company, to replace its zonal electricity market with a significantly more advanced nodal market. The state-of-the-art nodal market management system delivered by Ventyx is expected to save the consumer tens of millions of dollars annually and facilitate ERCOT's smart grid vision of more active consumer participation in managing consumption.

Title picture

When the independent system operator responsible for grid reliability and managing the wholesale electricity market in Texas wanted to upgrade to a more advanced nodal market model, they turned to Ventyx.





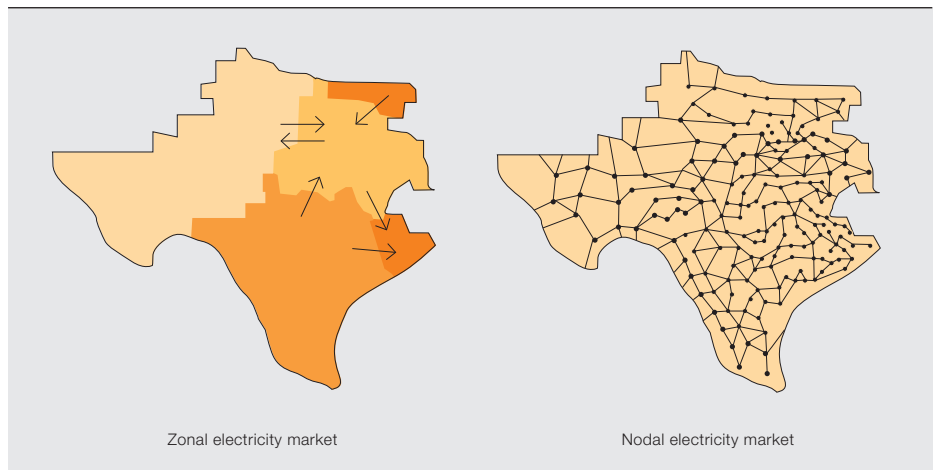

The restructuring of the electric utility industry is at different stages of evolution around the world. The general modus operandi is for designated system operators to be tasked with facilitating fair transmission access for all qualified generating and load entities, while maintaining system reliability. Restructuring in North America is at an advanced stage in which grid reliability and power exchanges are rigorously coordinated. ERCOT is the independent system operator (ISO) that is responsible for grid reliability and management of the wholesale electricity market in Texas. ERCOT's decision to upgrade its zonal market to a nodal one has improved market efficiency and management of transmission congestion.

A nodal electricity market accounts for the cost of congestion in transmission lines. This means that the power at two ends of a line, or, indeed, in every bus in the grid, may have a different market price → 1.

A zonal market, by contrast, ignores congestion cost at the individual line level and sets a single price over a very large area of the grid. Some systems have just one central zone while others may have multiple zones between which

the flow of electricity is naturally or artificially constrained.

It is important to note that an electricity market is not just about buying and selling energy, it also involves the procurement of various types of energy reserves, called ancillary services (AS). Some markets have expanded even further to include the trading of congestion revenue rights (CRR), as a hedge against transmission congestion affecting location-dependent energy prices.

Electric utility industry restructuring

Restructuring of the vertically integrated electric utilities into a competitive industry involves the creation of a combination of competitive energy and retail markets, as well as regulated transmission and distribution activities → 2. Well-organized markets for wholesale energy, ancillary services and transmission capacity are central components of restructuring [1]. The role of the markets is to allow trading

The earliest restructuring took place in the early 1980s, in Chile. The privatization of the UK electricity industry in 1990, which was a major event in the United Kingdom's restructuring, was used as a model, or at least as a catalyst, for restructuring in countries such as Australia and New Zealand, and some regions in Canada.

In North America, the federal energy regulatory commission (FERC) Orders 888 and 889 [2,3], issued in 1996, completely changed the electricity generation, transmission and distribution landscape. However, these orders – although partially successful – did not remove discriminatory behavior by the operators of the vertically integrated utilities. Consequently, various state and federal recommendations and mandates came into force, which led to the creation of ISOs and regional transmission organizations (RTOs). Their task is to maintain system reliability and manage wholesale markets

while providing fair transmission access to all participants.

Restructuring in Europe, at national, regional and continental levels, has also been advancing since the 1980s. Organizations such as the ENTSO-E are mandated by the European Union to facilitate and coordinate restructuring through standardization of market processes and protocols. Most countries in Asia, and some in Africa, have already adopted, or

Well-organized markets for wholesale energy, ancillary services and transmission capacity are central components of restructuring.

between generators, retailers and financial intermediaries, both for short-term delivery of electricity (spot market) and for future delivery periods (forward market).

tions such as the ENTSO-E are mandated by the European Union to facilitate and coordinate restructuring through standardization of market processes and protocols. Most countries in Asia, and some in Africa, have already adopted, or

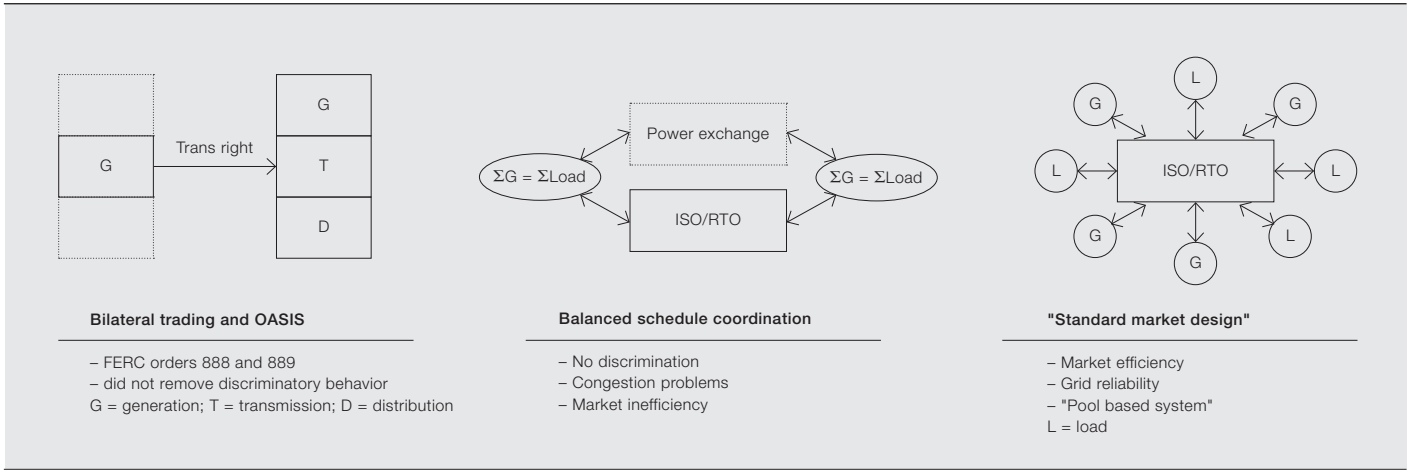

are in the process of adopting, various levels of restructuring.

Electricity markets

Electricity market designs generally fall into three categories: First, there are the vertically integrated legacy systems. Second, there are organized counter-trade markets with aggregate zonal transmission systems that support trading platforms that are sometimes separate, as well as scheduling procedures that are only partially integrated with sys-

most RTOs and ISOs – including the new ERCOT market – are part of this group. These markets mostly follow the principles of so-called standard market design, including centralized unit commitment and dispatch [5]. The New York ISO and ERCOT are examples of advanced nodal markets → 3.

As noted above, a key design difference between the zonal and nodal models is in the representation of the transmission network in managing congestion and

in determining the market clearing prices at each node or location. In a zonal design the grid is organized into congestion zones. To avoid congestion the system operator can balance the sources of generation. This

reduces congestion, but only between zones and not within zones. Nodal markets are able to address congestion within a zone as well as between zones. This flexibility facilitates market efficiency and improves reliability [4].

State-of-the-art solution

Operators of wholesale energy markets, and systems operators responsible for balancing markets, use market management systems (MMS) to operate their respective electricity markets and manage congestion. An MMS, at a minimum, includes an e-business infrastructure, a set of market applications for forecasting, market clearing and congestion

Texas is the largest electricity generating and consuming state by a considerable margin.

The day-ahead market co-optimizes the market for day-ahead ancillary service capacity, certain CRRs and forward financial energy transactions.

tem operations. The counter-trade refers to the activities of the system operator who must conduct offsetting transactions that undo the schedules of market participants and thus bring the net schedules into line with the capabilities of the grid. This includes most European electricity markets and the old ERCOT market. Third, there are the organized spot markets under ISOs who coordinate dispatch in a pool setting but who do not own the grid. They integrate real-time trading and dispatch with system operations. This integration caters for the full nodal granularity of the actual grid when determining energy flows and regional prices [4]. In the United States,

A nodal electricity market accounts for the cost of congestion in transmission lines.

3 ABB has global involvement in energy markets

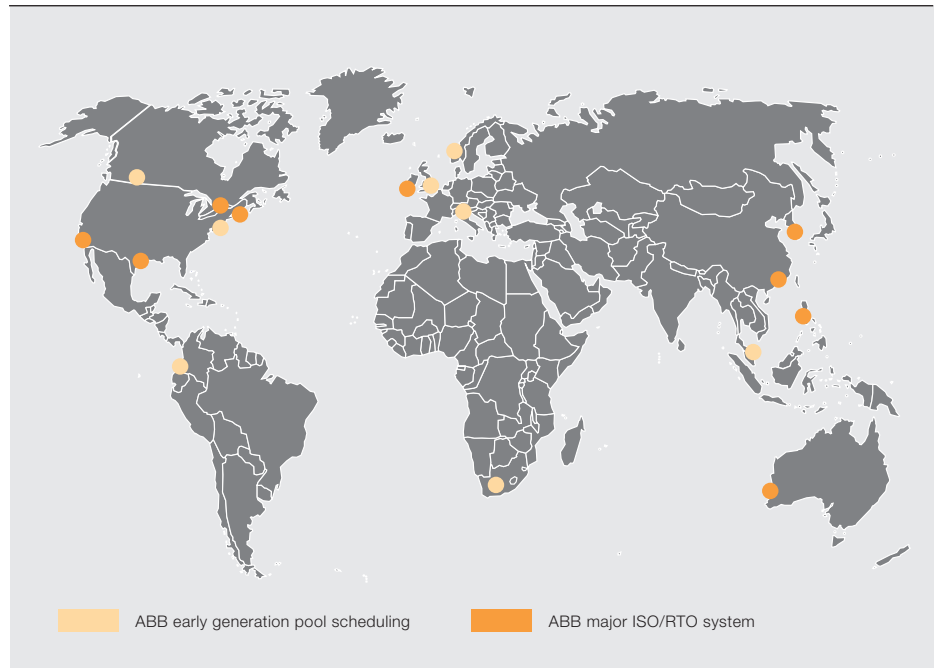

management, and an integration platform to provide an interface to various market and reliability entities and systems. State-of-the-art MMS solutions developed by Ventyx teams have been deployed at some of the largest and most sophisticated power markets around the world.

Components of a typical advanced MMS include:

- Trading and e-business infrastructure, including registration and market publishing functions.
- Market applications, including a market clearing engine, congestion management, load forecasting and

contract management. In a nodal market, the leading applications for the day-ahead market and the real-time market are, respectively, security con-

Early results show cost savings of millions of dollars as well as convergence of day-ahead and real-time prices.

ABB was the first vendor to implement a full-fledged MMS, which was delivered to the California independent system operator (CAISO) in 1998. This system, which is now part of the Ventyx portfolio, was used to operate the CAISO system reliably from 1998 to 2009 and was subjected to the toughest operational conditions during the California Energy Crisis in 2001. This MMS was the first system to co-optimize energy and ancillary services using a location-based marginal pricing model of the New York ISO's nodal market. ERCOT's nodal system is the latest and most advanced MMS delivered by Ventyx, with joint clearing of energy and CRRs – a first in the industry [6].

strained unit commitment (SCUC) and security constrained economic dispatch (SCED).

- Financial systems, including meter data management, settlements, billing and credit management.

Ventyx's MMS also includes a modern platform with a multitiered architecture that provides for high availability through clustering and load balancing, as well as flexibility in the choice of hardware and operating system → 4.

Meeting ERCOT's Needs

ERCOT manages the flow of electric power to 23 million Texas customers – representing 85 percent of the state's electric load. As the ISO, ERCOT is re-

4 A typical MMS system

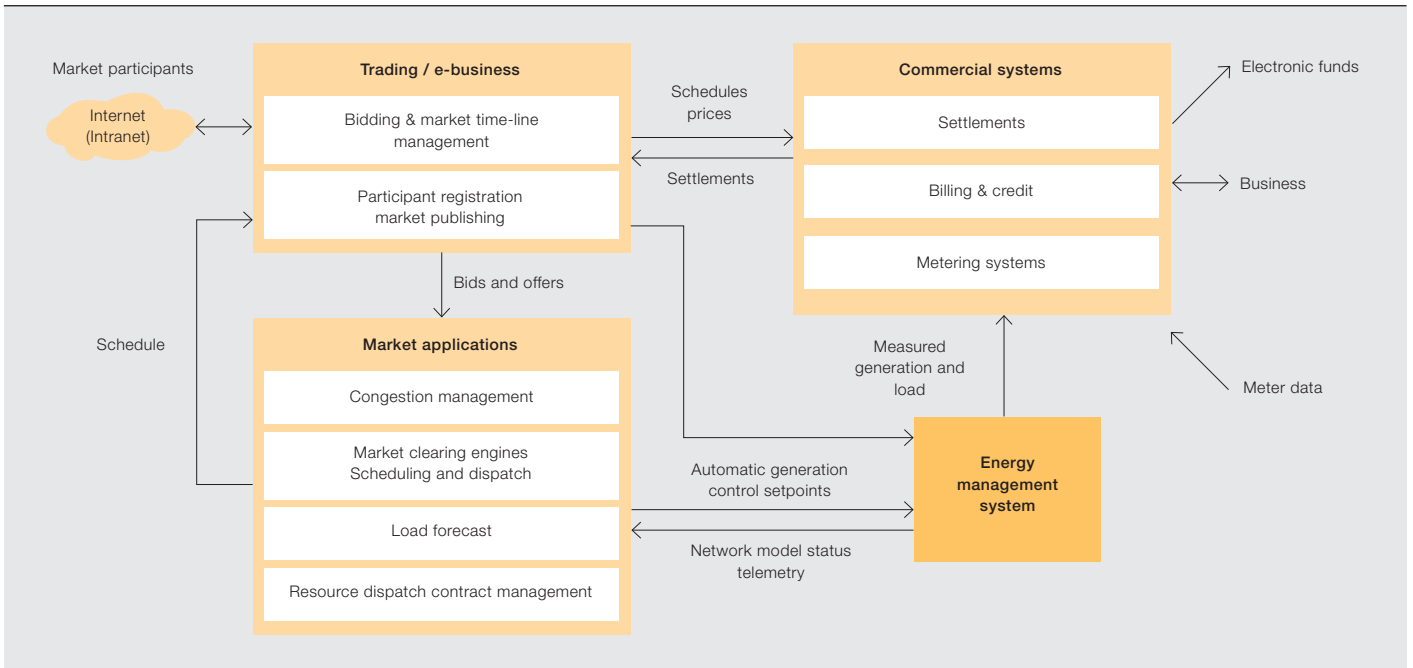

sponsible for the electricity market and it schedules power on an electric grid that connects over 64,000km of transmission lines to more than 550 generation units. The installed capacity is 84 GW with more than 10 GW of wind power.

The company also manages financial settlements for the competitive wholesale market and administers customer switching for 6.5 million Texans in competitive choice areas. The market size is \$34 billion.

ERCOT became an ISO in 1996 and, as a first step in deregulation, implemented a zonal market in 2002. Soon thereafter, the inefficiencies of the zonal design began to manifest themselves. In 2003, ERCOT was ordered by the public utility commission of Texas (PUCT) to develop a nodal market, with the goal of improving market and operating efficiencies through more rapid and granular pricing.

The new market management system

The nodal market is designed to remedy the shortcomings of the old zonal market by:

- Scheduling, bidding and deploying at the resource level
- Introducing resource-specific ramp rates in dispatch and shift factors
- Maintaining direct assignment of local congestion costs
- Implementing an integrated day-ahead market (DAM)

- Creating financial incentives for market participants to follow schedules and instructions

The features of the new market include:

- A nodal pricing mechanism for resources; aggregated prices for loads
- Energy and ancillary service offers evaluated together in day-ahead for higher market efficiency
- Centralized short-term reliability unit commitment for greater reliability
- Resource-specific high granularity for offers and dispatch
- New transmission hedging products (CRR)
- Separate settlement of day-ahead and real-time markets
- Full network model

The main components of the new MMS include: market infrastructure, day-ahead market, supplemental ancillary service market, reliability unit commitment, real-time security constrained economic dispatch and competitive constraint testing.

Market infrastructure

The market infrastructure provides a secure trading environment for qualifying entities to participate in the market. It uses a modern B2B infrastructure that utilizes Web services and has a friendly user interface. It includes business process solutions for market timeline man-

The outage scheduler handles thousands of rules representing ERCOT's security and business logic requirements.

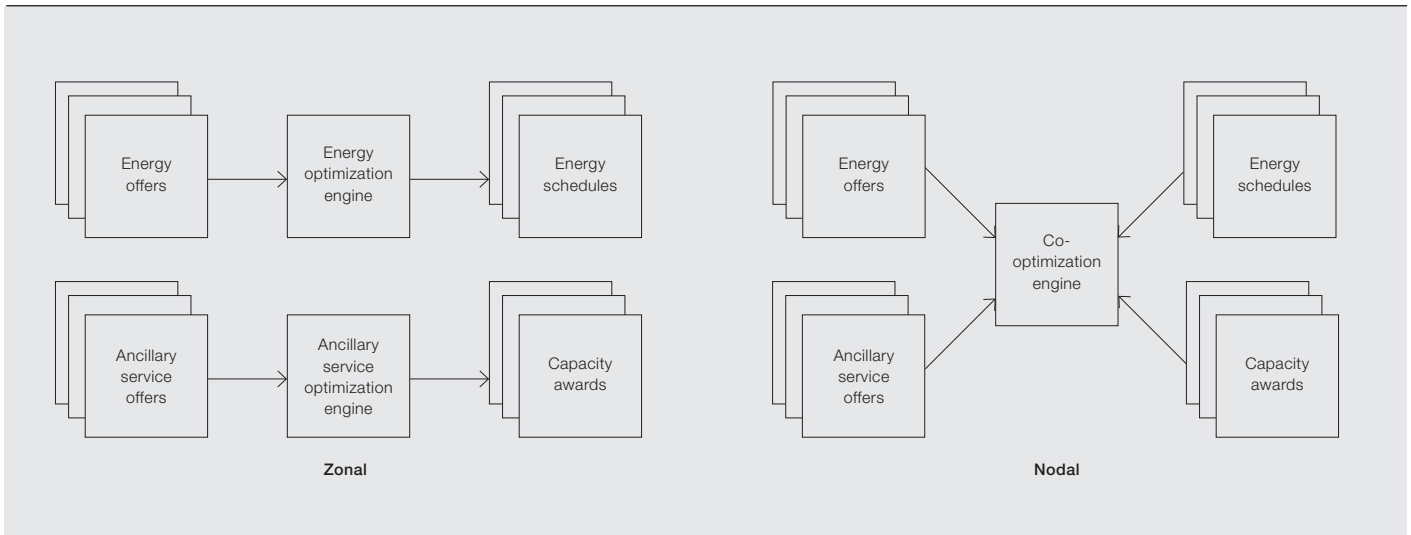

The DAM co-optimizes the market for day-ahead ancillary service capacity, certain CRRs and forward financial energy transactions.

agement and market rule and business logic validation using a rules engine.

Day-ahead market

The day-ahead market co-optimizes the market for day-ahead ancillary service capacity, certain CRRs and forward financial energy transactions. The co-optimization enables cost-effective and efficient operations.

The main engine for the DAM is an advanced security constrained unit commitment (SCUC) module that performs the market optimization, taking thousands of physical bids and offers, and hundreds of thousands of virtual bids, into consideration. The SCUC allows modelling of complex constraints for units such as ramp rates, forbidden regions, combined cycle plants and non-convex reserves. It uses advanced optimization and network analysis techniques to ensure network security utilizing a full nodal representation and thou-

sands of contingencies. The DAM process includes:

- Ancillary service obligation calculation
- Ancillary service insufficiency check
- Simultaneous feasibility testing for determination of oversold CRRs
- Derating of point-to-point options declared for real-time settlement

Supplemental ancillary service market

The supplemental ancillary service market is used during the adjustment period to procure additional ancillary services capacity.

Reliability unit commitment processes

The reliability unit commitment processes (weekly, day-ahead and hourly) are used to continuously evaluate and maintain system sufficiency and security. These processes determine commitment of resources to match the forecasted system demand, subject to transmission and resource constraints.

Security constrained economic dispatch

The security constrained economic dispatch (SCED) is used during real-time operations to produce the least-cost dispatch for online resources to match the total generation requirement, while observing resource and transmission constraints. The SCED process evaluates energy offer curves and output schedules to produce the base points for online generation resources.

Competitive constraint test

The competitive constraint test is performed on each potential competitive constraint to determine if the constraint is indeed competitive or not → 5.

The Outage Scheduler

In addition to the MMS, the solution delivered to ERCOT includes a state-of-the-art Outage Scheduler (OS) designed for the restructured operations. The OS provides efficient coordination of transmission equipment outages and generation and demand resources. Planned outages impact reliability and can severely influence market prices. ERCOT operators use the OS to effectively manage the complete life cycle of outage requests, which can exceed 100,000 a year. The market participants and transmission operators use the OS secure user interfaces and/or Web services to submit and manage their requested outages. The OS provides efficient methodology and advanced tools for configurable modeling of thousands of rules representing ERCOT's security and business logic requirements. The OS is fully integrated with other ERCOT systems to provide the required consistency and coordination of outages across the entire operation.

What a nodal market means for Texas

The ERCOT nodal market successfully went live on December 1, 2010 with the Ventyx MMS as its main engine. Operation results reflect production and regulation cost savings of millions of dollars as well as convergence of day-ahead

A cost benefit assessment sponsored by PUCT [8] projects that the quantifiable benefits of the ERCOT nodal market significantly outweigh nodal market implementation costs. The report indicates that the estimated net present value (NPV) of generation cost savings over 10 years is \$339 million while the overall benefit, including those from improved generation siting, is projected to exceed \$520 million. The report also estimates that the new market will facilitate a significant reduction – \$5.6 billion NPV over 10 years – in consumer wholesale payments for electricity.

ERCOT wholesale electricity market

The Ventyx MMS has enabled ERCOT to manage the new nodal market and achieve higher levels of system reliability and market and operating efficiencies. System reliability enhancements are achieved through the use of security constrained unit commitment and dispatch. Increasing the frequency with which the market-clearing price is calculated improves the market timeline from 15 to 5 minutes. The MMS is designed to meet the challenges of the ERCOT nodal market and it is flexible and responsive enough to accommodate expected and unforeseen market design changes. By bringing a sophisticated solution to bear, ERCOT is well positioned to meet the challenges it faces as a leader in the very competitive wholesale energy market.

Khosrow Moslehi

ABB Power Systems, Software
Santa Clara, CA, United States
khosrow.moslehi@us.abb.com

References

- [1] Jamasb, T., Pollitt, M. (2005). Electricity Market Reform in the European Union, 05-003 WP. Center for Energy and Environmental Policy Research.
- [2] FERC Order 888. (1996, April 24). Promoting Wholesale Competition Through Open Access Non-discriminatory Transmission Services by Public Utilities; Recovery of Stranded Costs by Public Utilities and Transmitting Utilities, Docket Nos. RM95-8-000 and RM94-7-001.
- [3] FERC Order 889. (1996, April 24). Open Access Same-Time Information System (formerly Real-Time Information Networks) and Standards of Conduct, Docket No. RM95-9-000.
- [4] Hogan, W. (2010). Electricity Wholesale Market Design in a Low Carbon Future. Retrieved 14th September, 2012, from http://www.hks.harvard.edu/fs/whogan/Hogan_Market_Design_012310.pdf
- [5] FERC Notice of Proposed Rulemaking (NOPR), Remedying Undue Discrimination Through Open Access Transmission Service and Standard Electricity Market Design, Docket No. RM01-12-000, July 31, 2002.
- [6] Mukerji, R. NYISO Day-Ahead Market Overview, FERC Unit Commitment Model Conference, Washington, DC, June 2-3, 2010. Retrieved 14th September, 2012, from <http://www.ferc.gov/eventcalendar/Files/20100530124757-Mukerji.New%20York%20ISO-060210.pdf>
- [7] ERCOT reports nodal market shows savings for Texans. Retrieved 14th September, 2012 from <http://www.competitivepower.org/article/ercot-reports-nodal-market-shows-savings-for-texans>
- [8] CRA for Public Utility Commission of Texas. (2008, December 18). Update on the ERCOT nodal market cost-benefit analysis. Retrieved Sept. 14, 2012 from http://www.puc.state.tx.us/industry/electric/reports/31600/PUCT_CBA_Report_Final.pdf

The market infrastructure provides a secure trading environment for qualifying entities to participate in the market.

and real-time prices [7]. ERCOT has reported that energy costs in the Electric Reliability Council of Texas wholesale market decreased approximately 13 percent in the first six months of the new nodal market.



Engineering success in Thailand

Provision of services to Dow's largest manufacturing site in Asia

PORNCHAI CHAIYAPON – Toward the end of 2011, Dow Chemical Company, together with joint venture partners Siam Cement Group and Solvay, completed one of the largest investments in the company's history – a multibillion dollar expansion of its manufacturing facilities at Map Ta Phut, Thailand. Known as the Thai Growth Project, the expansion encompassed five new plants and their integration with existing production units into a fully integrated complex of world-class downstream facilities – Dow's largest manufacturing site in Asia. ABB was one of Dow's key partners and largest suppliers in the project, providing and installing most of the electrical, control and instrumentation equipment, including the plant distributed control systems. All the facilities were commissioned and completed safely and successfully on time and within budget.



ABB has developed a number of features and functionalities for Extended Automation System 800xA on behalf of Dow.

Located 160 km south of Bangkok on a coastal site overlooking the Gulf of Thailand, the Map Ta Phut Industrial Estate is the heart of Thailand's petrochemical and petroleum industry. Dow Chemical Company, in collaboration with its joint venture partner Siam Cement Group (SCG), opened its first manufacturing facilities at the estate in 1993 – a styrene-butadiene latex plant and a polyurethane plant. These were followed by a long series of investments in new plants for the production of polystyrene, ethyl benzene and styrene monomer, solution polyethylene and a new naphtha cracker plant that was located on a separate site 6 km away → 1-2. Dow's investments did not stop there. By the end of 2008 the company had announced a new multibillion dollar investment in five additional plants that would strengthen its presence in Asia Pacific → 3.

The five plants were collectively known as the Thai Growth Project. They consisted of the following subprojects:

- 1) A new solution polyethylene train
- 2) A new specialty elastomers train
- 3) A new propylene oxide plant → 4
- 4) A new hydrogen peroxide plant, which is the largest in the world
- 5) Power, utilities and infrastructure for the entire site

In addition to the five core projects, Dow also invested in a new storage and export facility at the port of Map Ta Phut. Projects 1, 2 and 3 were joint ventures with SCG. Project 4 was a joint venture with Solvay.

Site-wide solutions

Dow provided the project management for all the aforementioned joint venture projects with SCG, while Solvay managed the hydrogen peroxide project. Foster Wheeler International Corporation was appointed the engineering, procurement and construction (EPC) contractor for several of the core projects. Toyo Thai provided the EPC services for the hydrogen peroxide facility, with Sino Thai performing most of the field construction

work. ABB was a major contributor both in terms of project involvement and the value of its products, systems and services.

Both Foster Wheeler and Dow, with whom ABB has a number of frame agreements for the global supply of various power and automation products and systems, awarded the contracts. ABB's scope of supply was huge and extended across the complete spectrum of electrical, control and instrumentation equipment and technologies. In fact, except for the main construction contractor, ABB was the largest supplier of materials, equipment and services. ABB supplied most of the switchgear, transformers, motors and drives, all the analytical equipment, all distributed control system hardware and most of the related programming services and most of the electrical and instrumentation installation work → 5.

Title picture
Aerial view of Dow's plant

1 Thermoplastic polyolefin cooling area



2 Thermoplastic polyolefin C3 compressor



ABB solutions were deployed in all five core projects, including the naphtha cracker plant, which went on-stream in 2010. ABB was responsible for delivery of the products and systems under its existing frame agreements with Dow, and for the installation, commissioning and testing of the electrical and instrumentation systems at most of the plants.

ABB was one of Dow's key partners in the project, providing and installing most of the electrical, control and instrumentation equipment.

Switching to System 800xA

Of the frame agreements that ABB has signed with Dow, the most notable was a 10-year global strategic agreement that the two companies signed in 2001 with regard to process automation systems. At the time the agreement was unique. It broke new ground in customer-supplier partnerships for mission-critical systems like process automation, and was subsequently extended in 2011 following a highly successful first decade.

For Dow, the agreement signaled a strategic shift away from its proprietary manufacturing operator discipline (MOD)

control platform of 25 years to ABB's Extended Automation System 800xA. The MOD system was the heart of Dow's operations; it contained all the company's process know-how and application expertise and was vital to daily production. The knowledge embodied in MOD is now integrated with System 800xA. This enabled Dow to concentrate on its core business activities of chemical production and leave control system development to its partner, ABB.

In brief, the agreement meant that ABB supplied Dow with new and retrofit process automation systems, as well as service and support, for all Dow manufacturing sites worldwide. In return, Dow shared knowledge of process automation technology and practices with ABB for incorporation into its automation products and solutions. On the human level, teams representing the two companies worked as a tightly integrated unit that thought, worked and operated as a single Dow-ABB entity.

Over the years, ABB has developed a number of features and functionalities for System 800xA on behalf of Dow. These features were subsequently made commercially available to other customers as part of the System 800xA offering. Two examples of this joint product development, which are now firmly established as System 800xA differentiators, are Load-Evaluate-GO and High Integrity integrated control and safety systems.

Load-Evaluate-GO allows users to modify, download and evaluate a new or revised application, without interfering with

3 Piling activity started in 2008



the running application. They can see how the new application will work with their controllers and I/O systems and how it will affect the production process, while still continuing to run the current application. This capability significantly reduces the risks associated with making application changes in the running process, and improves overall efficiency by avoiding production stops, missed or delayed product deliveries and costly downtime.

System 800xA High Integrity is a complete, scalable IEC 61508 and IEC 61511 compliant safety-instrumented system that spans the entire plant safety loop.

The 10-year global strategic agreement broke new ground in customer-supplier partnerships for mission-critical systems like process automation.

Providing embedded safety and control within the same architecture offers a common high-integrity-system environment for production control, safety supervision and production monitoring. This flexible architecture makes it possible to combine control and safety functions within the same controller or keep control and safety functions separate within the same system.

Both capabilities are true to ABB's System 800xA philosophy – that the system extends beyond the scope of traditional

control systems to include all automation functions in a single operations and engineering environment, so that plants can run smarter and better at substantial cost savings. Its unique engineering environment manages one set of consistent data, for single-point entry, single-point change and reuse across the plant.

Best contractor awards

Being part of a project of this size and complexity was both a privilege and a huge challenge. The schedule was tight – 30 months from start to finish – and the demands were exacting. Roughly 9,000 contractors were working on-site at various times throughout the project. On a macro level there was the 2008 global financial and economic crisis to contend with and on a local level there was political instability in Thailand for several months and a number of unexpected regulatory issues that had to be resolved.

As a supplier, ABB was required to execute its obligations flawlessly by meeting all delivery schedules punctually and by enabling plant start-up to take place on time and problem-free. The ability to think with the customer and quickly adapt to changing requirements were key attributes in a project of this size. In fact, ABB was rewarded with five awards for achieving major milestones in project execution and three awards for safety.

4 Propylene oxide plant



The two milestones were connected with the propylene oxide plant: one from Foster Wheeler for completing the electrical and instrumentation installation within a very demanding timeframe; and the second from Dow for completing and energizing a 115kV substation on time, despite a delay of almost three months caused by regulatory issues that brought the entire Thai Growth Project to a halt.

Health and safety benchmark

What is remarkable about the Thai Growth Project is that it was accomplished with an outstanding record in environment, health and safety issues (EH&S). Some 41 million man-hours were expended throughout the project's duration. The injury/incident recordable rate was less than 0.07 and there was no time lost to injuries. This was an exceptional achievement that is thought to have set a new benchmark in the global chemical and petrochemical industry.

With all five core projects completed, the process will be rounded off in 2012 when Dow evaluates the lessons learned from the Dow-ABB collaboration in the Thai Growth Project as part of the ongoing process of improving work procedures and practices between the two companies. A sixth core project, for a new propylene glycol plant, is currently under construction and scheduled for completion in 2012. ABB has already been selected by Dow to provide the process automation system and much of the electrical equipment, instrumentation and analyzers, including installation and commissioning.

ABB was rewarded with five awards for achieving major milestones in project execution.

5 Operators working in the control room



The next Dow-ABB project

Dow announced in 2011 that along with its partner, Saudi Arabian Oil Company (Saudi Aramco), it had formed a joint venture – Sadara Chemical Company – to build, own and operate a fully integrated chemicals complex in Jubail Industrial City, Saudi Arabia.

The complex will comprise 26 manufacturing units with capacities of more than 3 million metric tons a year and will be the world's largest integrated chemical facility ever built in single phase. The manufacturing units will produce a wide range of performance products such as polyurethanes (isocyanates, polyether polyols), propylene glycol, elastomers, linear low-density polyethylene, low-density polyethylene, glycol ethers and amines.

Construction began in late 2011, with the first production units expected to come online in 2015 and all units up and running by 2016. Sadara is expected to deliver annual revenues of \$10 billion within a few years of operation. Total investment for the project, including third-party investments, is approximately \$20 billion.

ABB has been selected as the main automation contractor for the Sadara project. ABB's scope of supply is comprehensive and critical. It includes process automation systems, safety systems, project management, project engineering, commissioning assistance, post-commissioning site support, as well as engineering, operator and maintenance technician training.

Pornchai Chaiyapon

ABB Process Automation

Bangkok, Thailand

pornchai.chaiyapon@th.abb.com

Innovation



- 6 Innovation highlights**
ABB's top innovations for 2012
- 11 Traction transformation**
A power-electronic traction transformer (PETT)
- 18 SafeLink CB switchgear**
An innovative, integrated secondary distribution solution
- 22 SF₆ and a world first**
ABB launches the first-ever SF₆ recycling center
- 27 Eliminating downtime**
Keeping the power flowing during grid instabilities
- 30 Power fitness**
Reliable voltage protection of sensitive loads
- 34 The power of integration**
Reaching new levels of productivity in the automation industry
- 41 Controlling the living factory**
Modeling a mammalian cell culture for an online process control system
- 47 The fieldbus outside the field**
Soft FF reduces commissioning effort simulating Foundation Fieldbus
- 53 Winning by design**
Innovative door communication system wins international design award
- 56 The frugal manufacturer**
Regulatory issues set the agenda (part 3)

Trends in technology



- 6 Collaborating in a new dimension**
An interactive display helps make the right decisions
- 13 Expert access – anytime, anywhere**
ServicePort delivers top process expertise to anywhere in the world
- 18 Energy control at your fingertips**
Award-winning technology delivers an unprecedented insight into energy usage
- 23 Red robots in the red house**
ABB robots help a traditional Black Forest brewery
- 26 Looking within**
ABB is making use of its own IRB 140 robots to step up productivity, improve quality and reduce costs in its own factories
- 29 Onboard DC grid**
The newest design for marine power and propulsion systems
- 34 Raising the waters**
Lift irrigation is getting a boost from ABB's synchronous motors
- 40 Distribution goes green**
ABB's amorphous metal distribution transformers are maximizing energy savings
- 49 Transformers transformed**
Using vegetable oil as an insulating fluid reduces transformer fire risk

Software



- 6 ABB's software is everywhere**
Why ABB is a software company
- 12 A parallel future**
Continuing innovation for next-generation real-time controllers through software
- 17 Bridging customer needs**
A movable bridge application arises out of embedded control programs in ABB low-voltage drives
- 23 IT/OT convergence**
How their coming together increases distribution system performance
- 28 A capital asset**
The PAS 55 specification and enterprise asset management
- 35 Scaling factors**
Software scalability for ABB's future IT
- 39 Optimizing mining operations**
Integration across the mining enterprise is key to increased productivity
- 44 Model behavior**
Using distribution models to deliver smart grid volt/var control
- 52 Better together**
The value of transforming data into actionable intelligence
- 59 Taking the initiative**
ABB's software development improvement initiative bears fruit
- 64 Cyber security**
Protecting critical infrastructure in a changing world
- 70 ABB drives training home**
ABB helps set up and equip drives training center in Austria
- 75 Sea change**
ABB will set the standard for software on ships

Service



- 7 Service and R&D**
ABB's service technologies are crucial to ensuring longevity in its products
- 13 Remote, but close**
Improving operations and maintenance with remote optimization
- 18 Global reach, local support**
ABB's global SIU organization provides local support to robots across the world
- 25 Service solutions**
A look at what is to come
- 32 Fingerprint analysis**
Optimizing boiler efficiency pays off
- 37 Productive predictions**
Life expectancy analysis improves maintenance management of high-voltage motors and generators
- 42 Seeing through switchgear**
Radiographic inspection saves costs and downtime and enables better maintenance planning
- 46 Always in touch**
Adapting mobile devices to industrial applications
- 53 Protection from cyber threats**
Can utilities and industries afford a cyber security breach?
- 59 Sustainable energy reductions**
ABB's industrial energy efficiency solutions are delivering accelerated energy savings to industry
- 64 Texas transformed**
Achieving significant savings through a new electricity market management system
- 72 Engineering success in Thailand**
Provision of services to Dow's largest manufacturing site in Asia
- 77 Index 2012**
The year at a glance

Editorial Board

Prith Banerjee

Chief Technology Officer and
Executive Vice President

Clarissa Haller

Head of Corporate Communications

Ron Popper

Head of Corporate Responsibility

Eero Jaaskela

Head of Group Account Management

Andreas Moglestue

Chief Editor, *ABB Review*

Publisher

ABB Review is published by ABB Group R&D and
Technology.

ABB Technology Ltd.

ABB Review

Affolternstrasse 44

CH-8050 Zurich

Switzerland

abb.review@ch.abb.com

ABB Review is published four times a year in
English, French, German, Spanish, Chinese and
Russian. *ABB Review* is free of charge to those with
an interest in ABB's technology and objectives.
For a subscription, please contact your nearest
ABB representative or subscribe online at
www.abb.com/abbreview

Partial reprints or reproductions are permitted
subject to full acknowledgement. Complete reprints
require the publisher's written consent.

Publisher and copyright ©2012

ABB Technology Ltd.

Zurich/Switzerland

Printer

Vorarlberger Verlagsanstalt GmbH

AT-6850 Dornbirn/Austria

Layout

DAVILLA AG

Zurich/Switzerland

Disclaimer

The information contained herein reflects the views
of the authors and is for informational purposes
only. Readers should not act upon the information
contained herein without seeking professional
advice. We make publications available with the
understanding that the authors are not rendering
technical or other professional advice or opinions
on specific facts or matters and assume no
liability whatsoever in connection with their use.
The companies of the ABB Group do not make any
warranty or guarantee, or promise, expressed or
implied, concerning the content or accuracy of the
views expressed herein.

ISSN: 1013-3119

www.abb.com/abbreview



Preview 1113

Innovation

Technology and its applications are in a state of continuous evolution. Much that seemed utopic some decades ago is now not only possible, but has become an integral part of daily life. Investments in R&D do not merely push for the incremental streamlining of products and businesses, but can also contribute to more far reaching and disruptive changes, the scale of which may not always initially be obvious.

Of course not every innovation sets out to change the world. Their immediate effect may concern only a particular industry or process, but resulting efficiencies or technologies may find unforeseen applications elsewhere. Research is thus very much an exploration of uncharted waters, and one in which relatively small changes can have far-reaching effects.

Every year, *ABB Review* dedicates its first edition to the celebration of innovation, and presents a selection of the company's recent and upcoming achievements. After this issue of *ABB Review* went to press, ABB announced a historical breakthrough in electric power transmission – the world's first hybrid HVDC circuit breaker. This achievement paves the way for HVDC grid evolution and will be highlighted in issue 1/2013.



Cut CO₂ emissions by 260 million tons a year?

In 2011 alone, the power saved by our installed base of drives cut global CO₂ emissions by 260 million tons. This intelligent motor control system that adjusts the speed and reduces the amount of energy used by motor-driven equipment is just one of many ABB power and automation solutions to manage energy consumption efficiently, reduce carbon emissions and bring savings to our customers. www.abb.com/betterworld

Absolutely.