

$V_{CE} = 1700\text{ V}$

$I_C = 800\text{ A}$

HiPak

IGBT Module

5SND 0800M170100

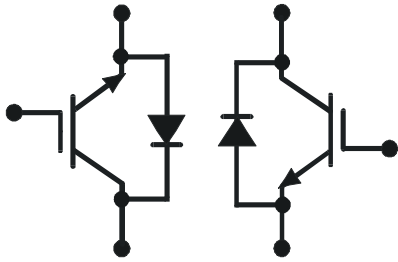

Doc. No. 5SYA1589-02 10 2020

- Low-loss, rugged SPT chip-set
- Smooth switching SPT chip-set for good EMC
- Industry standard package
- High power density
- AISiC base-plate for high power cycling capability
- AlN substrate for low thermal resistance
- 2 switches in one package
- Improved high reliability package
- Recognized under UL1557, File E196689



Maximum rated values ¹⁾

Parameter	Symbol	Conditions	min	max	Unit
Collector-emitter voltage	V_{CES}	$V_{GE} = 0\text{ V}$, $T_{vj} \geq 25\text{ °C}$		1700	V
DC collector current	I_C	$T_c = 80\text{ °C}$		800	A
Peak collector current	I_{CM}	$t_p = 1\text{ ms}$, $T_c = 80\text{ °C}$		1600	A
Gate-emitter voltage	V_{GES}		-20	20	V
Total power dissipation	P_{tot}	$T_c = 25\text{ °C}$, per switch (IGBT)		4800	W
DC forward current	I_F			800	A
Peak forward current	I_{FRM}			1600	A
Surge current	I_{FSM}	$V_R = 0\text{ V}$, $T_{vj} = 125\text{ °C}$, $t_p = 10\text{ ms}$, half-sinewave		6600	A
IGBT short circuit SOA	t_{psc}	$V_{CC} = 1200\text{ V}$, $V_{CEMCHIP} \leq 1700\text{ V}$ $V_{GE} \leq 15\text{ V}$, $T_{vj} \leq 125\text{ °C}$		10	μs
Isolation voltage	V_{isol}	1 min, $f = 50\text{ Hz}$		4000	V
Junction temperature	T_{vj}			150	$^{\circ}\text{C}$
Junction operating temperature	$T_{vj(op)}$		-40	125	$^{\circ}\text{C}$
Case temperature	T_c		-40	125	$^{\circ}\text{C}$
Storage temperature	T_{stg}		-40	125	$^{\circ}\text{C}$
Mounting torques ²⁾	M_s	Base-heatsink, M6 screws	4	6	Nm
	M_{t1}	Main terminals, M8 screws	8	10	
	M_{t2}	Auxiliary terminals, M4 screws	2	3	

¹⁾ Maximum rated values indicate limits beyond which damage to the device may occur per IEC 60747

²⁾ For detailed mounting instructions refer to document no. 5SYA 2039 - 01

IGBT characteristic values ³⁾

Parameter	Symbol	Conditions	min	typ	max	Unit	
Collector (-emitter) breakdown voltage	$V_{(BR)CES}$	$V_{GE} = 0 \text{ V}$, $I_C = 10 \text{ mA}$, $T_{vj} = 25 \text{ °C}$	1700			V	
Collector-emitter ⁴⁾ saturation voltage	$V_{CE \text{ sat}}$	$I_C = 800 \text{ A}$, $V_{GE} = 15 \text{ V}$	$T_{vj} = 25 \text{ °C}$	2.0	2.3	2.6	V
			$T_{vj} = 125 \text{ °C}$	2.3	2.6	2.9	V
Collector cut-off current	I_{CES}	$V_{CE} = 1700 \text{ V}$, $V_{GE} = 0 \text{ V}$	$T_{vj} = 25 \text{ °C}$			4	mA
			$T_{vj} = 125 \text{ °C}$			40	mA
Gate leakage current	I_{GES}	$V_{CE} = 0 \text{ V}$, $V_{GE} = \pm 20 \text{ V}$, $T_{vj} = 125 \text{ °C}$	-500		500	nA	
Gate-emitter threshold voltage	$V_{GE(TO)}$	$I_C = 80 \text{ mA}$, $V_{CE} = V_{GE}$, $T_{vj} = 25 \text{ °C}$	4.5		6.5	V	
Gate charge	Q_{ge}	$I_C = 800 \text{ A}$, $V_{CE} = 900 \text{ V}$, $V_{GE} = -15 \text{ V} \dots 15 \text{ V}$		7.3		μC	
Input capacitance	C_{ies}	$V_{CE} = 25 \text{ V}$, $V_{GE} = 0 \text{ V}$, $f = 1 \text{ MHz}$, $T_{vj} = 25 \text{ °C}$		76		nF	
Output capacitance	C_{oes}			7.3			
Reverse transfer capacitance	C_{res}			3.2			
Turn-on delay time	$t_{d(on)}$	$V_{CC} = 900 \text{ V}$, $I_C = 800 \text{ A}$, $R_G = 1.2 \text{ }\Omega$,	$T_{vj} = 25 \text{ °C}$	485		ns	
			$T_{vj} = 125 \text{ °C}$	485			
Rise time	t_r	$V_{GE} = \pm 15 \text{ V}$, $L_\sigma = 80 \text{ nH}$, inductive load	$T_{vj} = 25 \text{ °C}$	165		ns	
			$T_{vj} = 125 \text{ °C}$	170			
Turn-off delay time	$t_{d(off)}$	$V_{CC} = 900 \text{ V}$, $I_C = 800 \text{ A}$, $R_G = 1.8 \text{ }\Omega$,	$T_{vj} = 25 \text{ °C}$	790		ns	
			$T_{vj} = 125 \text{ °C}$	875			
Fall time	t_f	$V_{GE} = \pm 15 \text{ V}$, $L_\sigma = 80 \text{ nH}$, inductive load	$T_{vj} = 25 \text{ °C}$	160		ns	
			$T_{vj} = 125 \text{ °C}$	185			
Turn-on switching energy	E_{on}	$V_{CC} = 900 \text{ V}$, $I_C = 800 \text{ A}$, $V_{GE} = \pm 15 \text{ V}$, $R_G = 1.2 \text{ }\Omega$, $L_\sigma = 80 \text{ nH}$, inductive load	$T_{vj} = 25 \text{ °C}$	160		mJ	
			$T_{vj} = 125 \text{ °C}$	250			
Turn-off switching energy	E_{off}	$V_{CC} = 900 \text{ V}$, $I_C = 800 \text{ A}$, $V_{GE} = \pm 15 \text{ V}$, $R_G = 1.8 \text{ }\Omega$, $L_\sigma = 80 \text{ nH}$, inductive load	$T_{vj} = 25 \text{ °C}$	220		mJ	
			$T_{vj} = 125 \text{ °C}$	300			
Short circuit current	I_{SC}	$t_{psc} \leq 10 \text{ }\mu\text{s}$, $V_{GE} = 15 \text{ V}$, $T_{vj} = 125 \text{ °C}$, $V_{CC} = 1200 \text{ V}$, $V_{CEM \text{ CHIP}} \leq 1700 \text{ V}$		3600		A	
Module stray inductance	$L_{\sigma \text{ CE}}$	per switch		24		nH	
Resistance, terminal-chip	$R_{CC+EE'}$	per switch	$T_C = 25 \text{ °C}$	0.18		m Ω	
			$T_C = 125 \text{ °C}$	0.255			

³⁾ Characteristic values according to IEC 60747 – 9⁴⁾ Collector-emitter saturation voltage is given at chip level

Diode characteristic values ⁵⁾

Parameter	Symbol	Conditions	min	typ	max	Unit
Forward voltage ⁶⁾	V_F	$I_F = 800 \text{ A}$	$T_{vj} = 25 \text{ °C}$	1.65	2.0	V
			$T_{vj} = 125 \text{ °C}$		1.7	
Reverse recovery current	I_{rr}		$T_{vj} = 25 \text{ °C}$	560		A
			$T_{vj} = 125 \text{ °C}$		730	
Recovered charge	Q_{rr}	$V_{CC} = 900 \text{ V}$, $I_F = 800 \text{ A}$, $V_{GE} = \pm 15 \text{ V}$, $R_G = 1.2 \text{ } \Omega$	$T_{vj} = 25 \text{ °C}$	210		μC
			$T_{vj} = 125 \text{ °C}$		385	
Reverse recovery time	t_{rr}	$L_\sigma = 80 \text{ nH}$ inductive load	$T_{vj} = 25 \text{ °C}$	690		ns
			$T_{vj} = 125 \text{ °C}$		975	
Reverse recovery energy	E_{rec}		$T_{vj} = 25 \text{ °C}$	150		mJ
			$T_{vj} = 125 \text{ °C}$		270	

⁵⁾ Characteristic values according to IEC 60747 – 2

⁶⁾ Forward voltage is given at chip level

Thermal properties ⁷⁾

Parameter	Symbol	Conditions	min	typ	max	Unit
IGBT thermal resistance junction to case	$R_{th(j-c)IGBT}$	per switch			0.021	K/W
Diode thermal resistance junction to case	$R_{th(j-c)DIODE}$				0.036	K/W
IGBT thermal resistance ²⁾ case to heatsink	$R_{th(c-s)IGBT}$	IGBT per switch, λ grease = $1\text{W/m} \times \text{K}$		0.024		K/W
Diode thermal resistance ⁷⁾ case to heatsink	$R_{th(c-s)DIODE}$	Diode per switch, λ grease = $1\text{W/m} \times \text{K}$		0.048		K/W

²⁾ For detailed mounting instructions refer to document no. 5SYA 2039 - 01

Mechanical properties ⁷⁾

Parameter	Symbol	Conditions	min	typ	max	Unit
Dimensions	$L \times W \times H$	Typical , see outline drawing	130 x 140 x 38			mm
Comparative tracking index	CTI		600			
Clearance distance in air	d_a	according to IEC 60664-1 and EN 50124-1	Term. to base:	10		mm
			Term. to term:	10		
Surface creepage distance	d_s	according to IEC 60664-1 and EN 50124-1	Term. to base:	15		mm
			Term. to term:	15		
Mass	m			820		g

⁷⁾ Thermal and mechanical properties according to IEC 60747 – 15

Electrical configuration

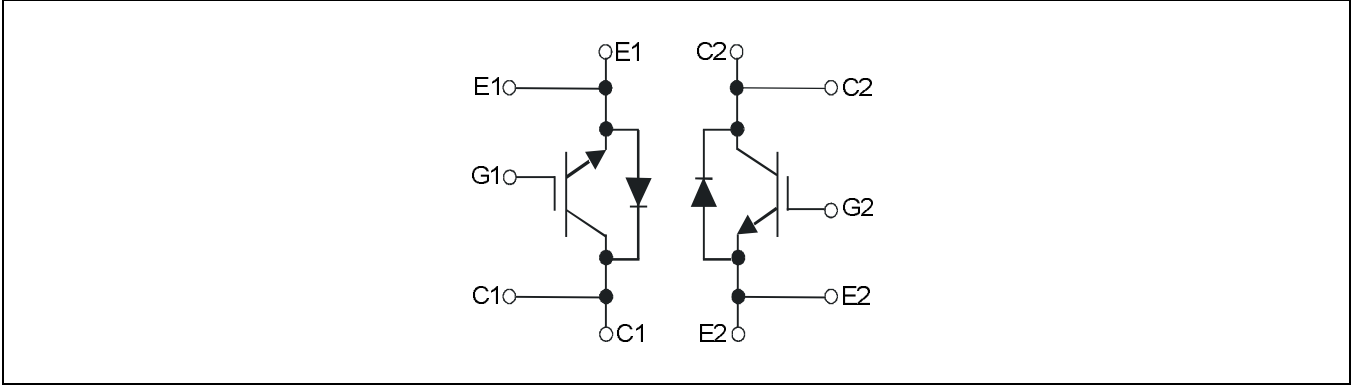

Outline drawing ²⁾

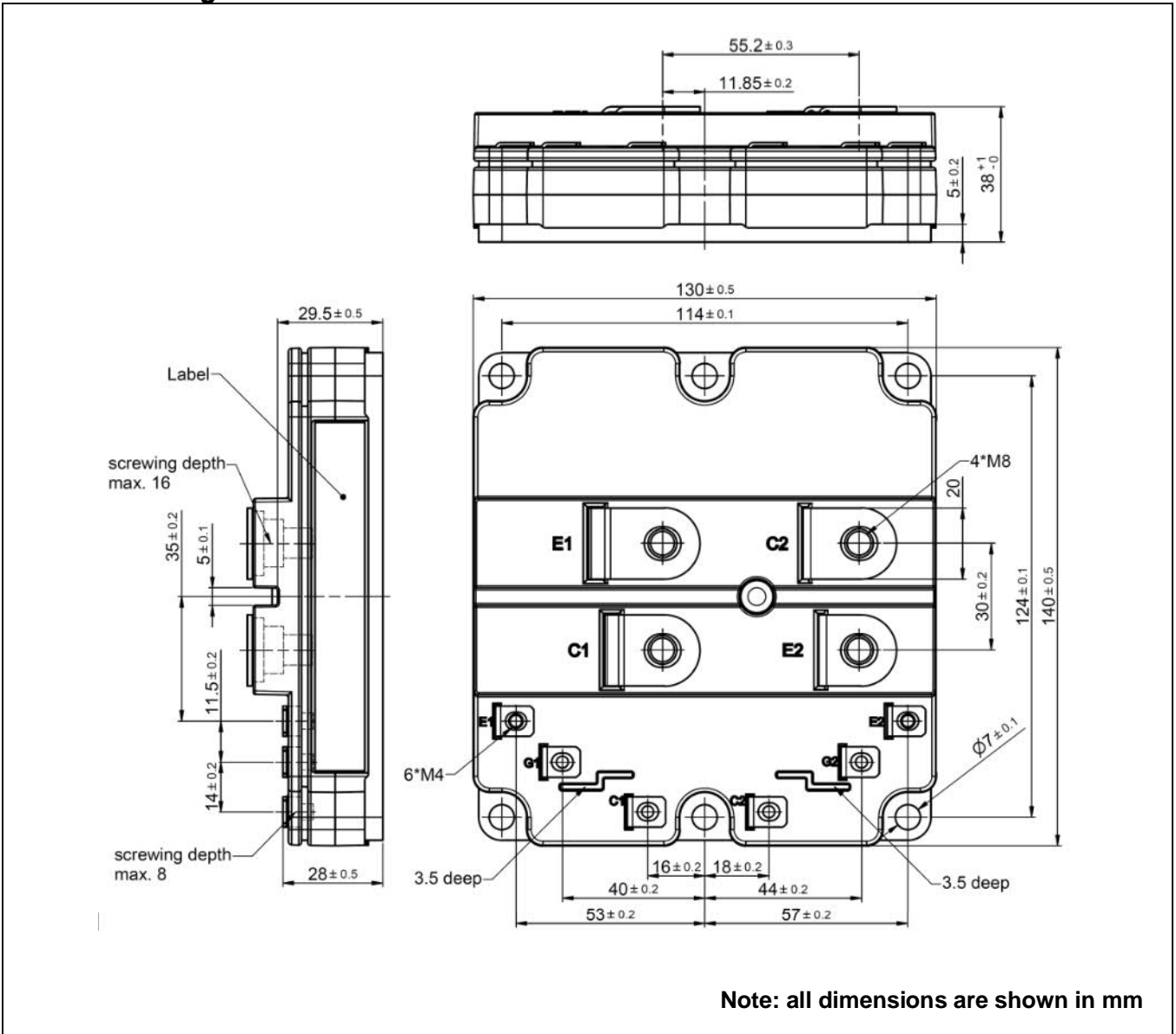

Note: all dimensions are shown in mm

²⁾ For detailed mounting instructions refer to document no. 5SYA 2039 - 01

This is an electrostatic sensitive device, please observe the international standard IEC 60747-1, chap. IX. This product has been designed and qualified for industrial level.

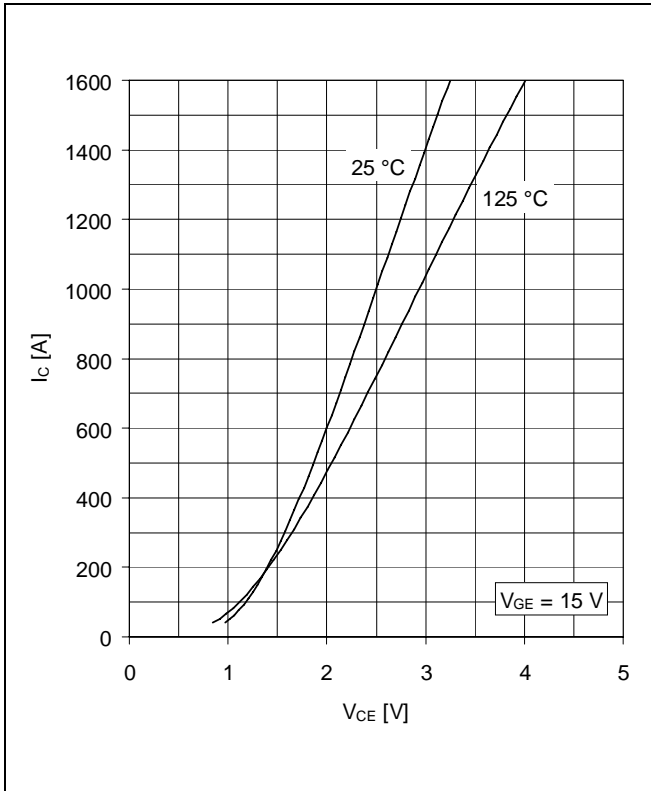

Fig. 1 Typical on-state characteristics, chip level

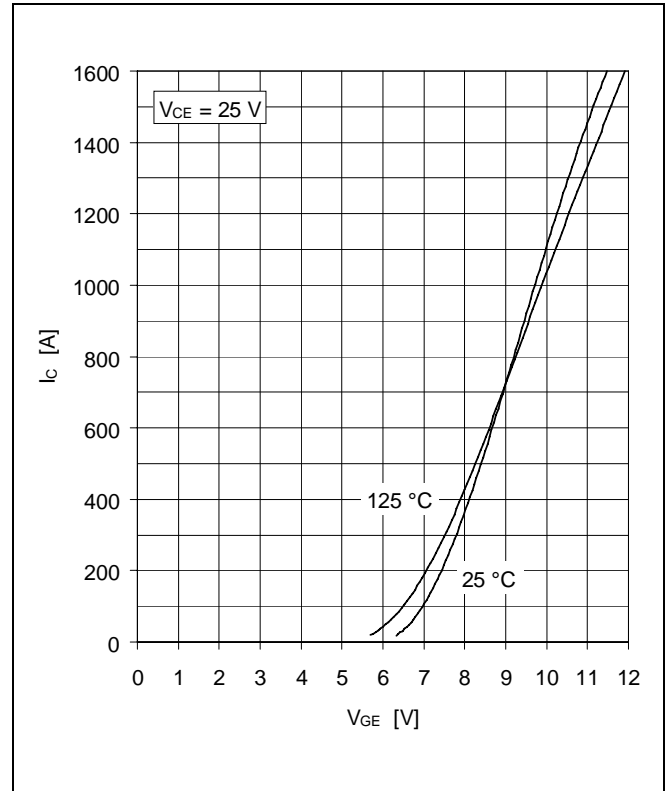

Fig. 2 Typical transfer characteristics, chip level

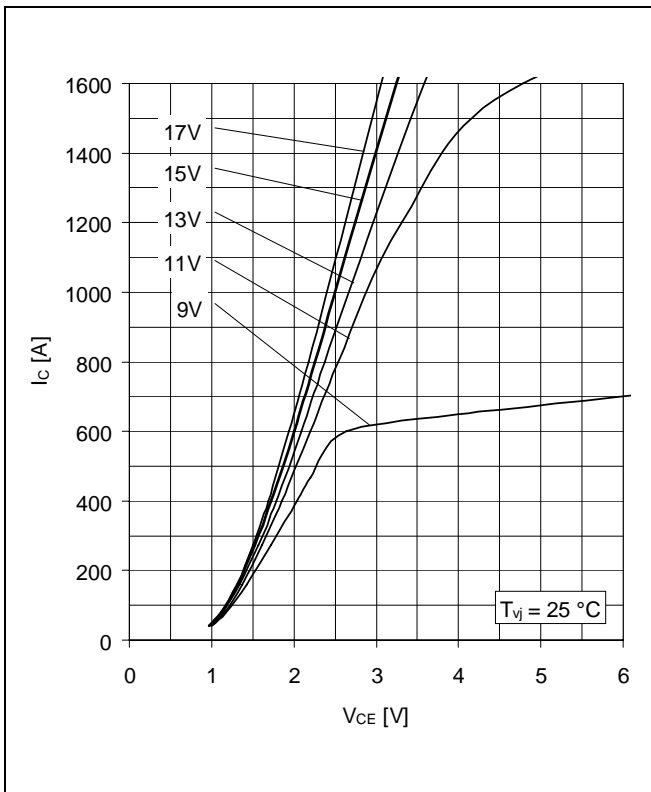

Fig. 3 Typical output characteristics, chip level

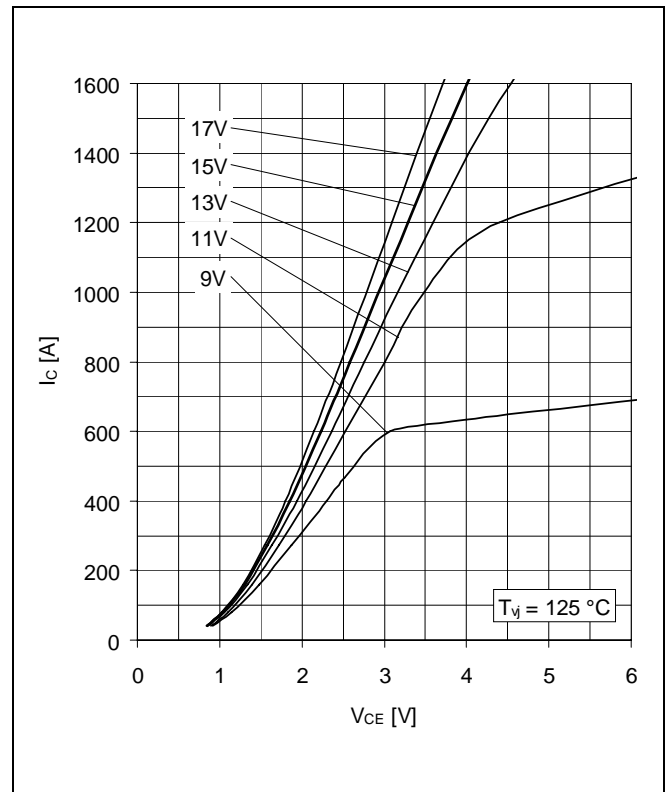

Fig. 4 Typical output characteristics, chip level

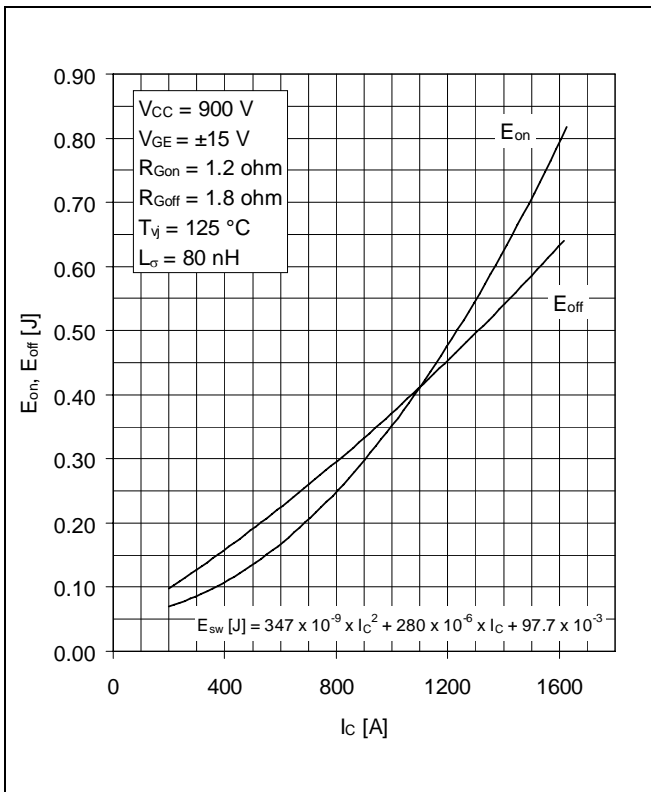

Fig. 5 Typical switching energies per pulse vs collector current

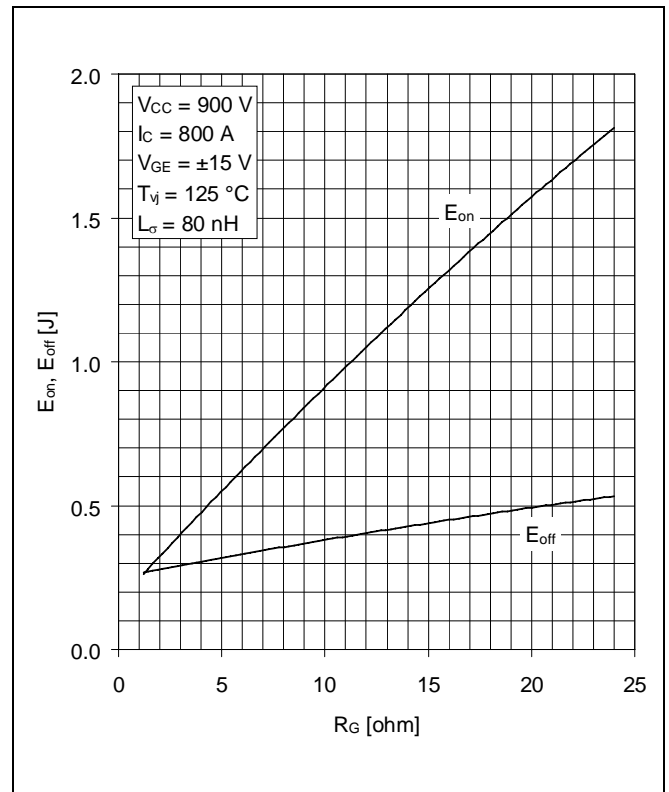

Fig. 6 Typical switching energies per pulse vs gate resistor

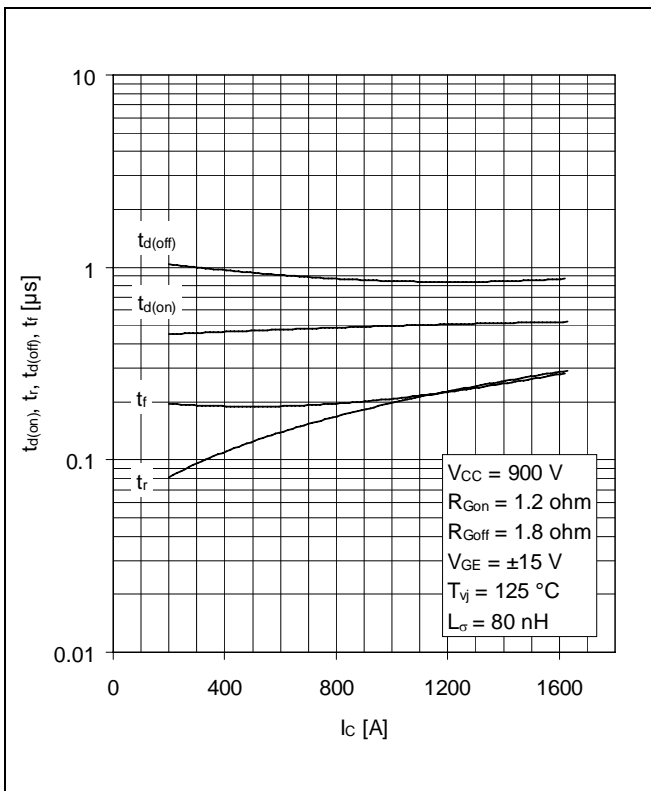

Fig. 7 Typical switching times vs collector current

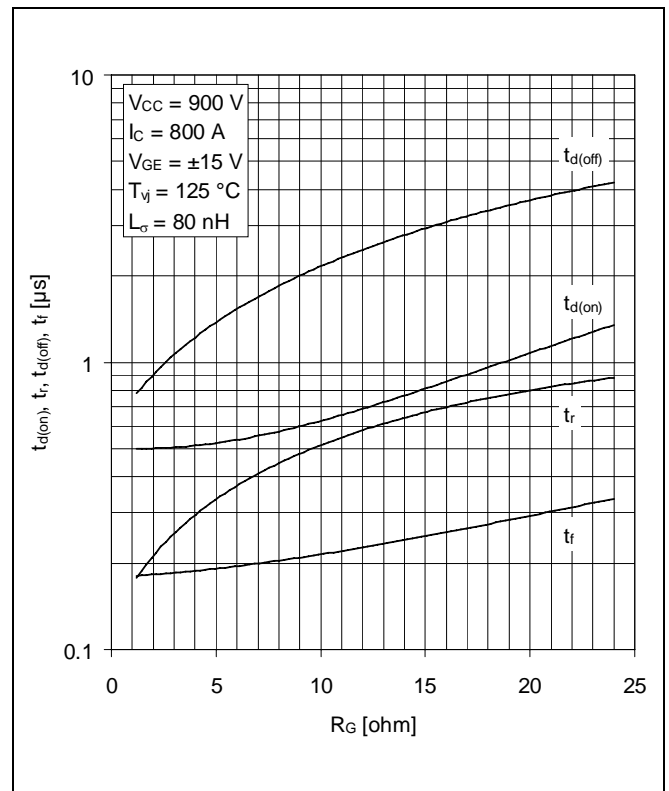

Fig. 8 Typical switching times vs gate resistor

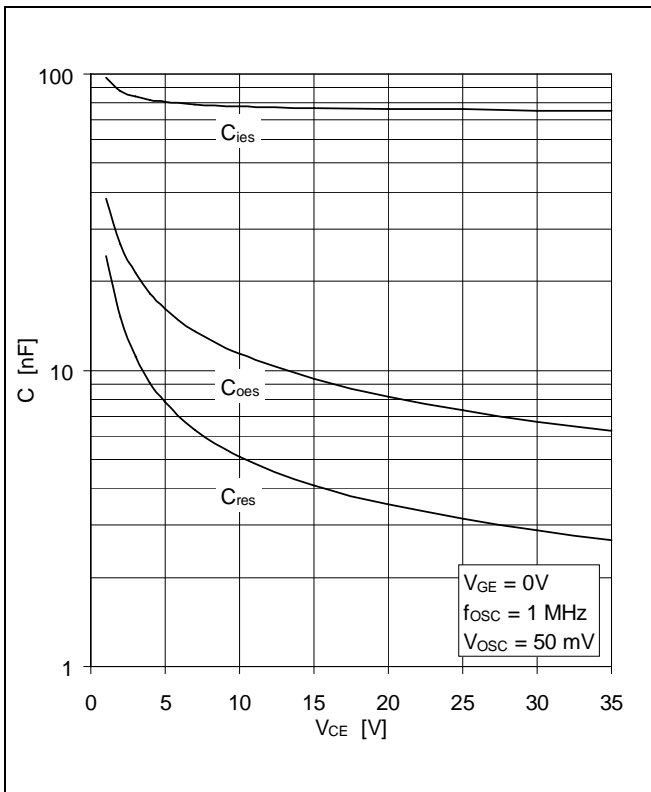

Fig. 9 Typical capacitances vs collector-emitter voltage

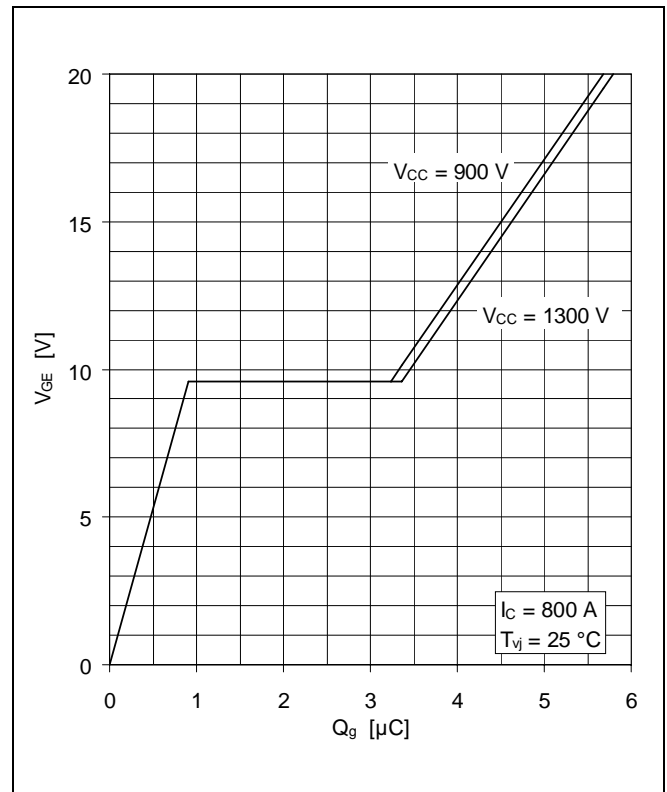

Fig. 10 Typical gate charge characteristics

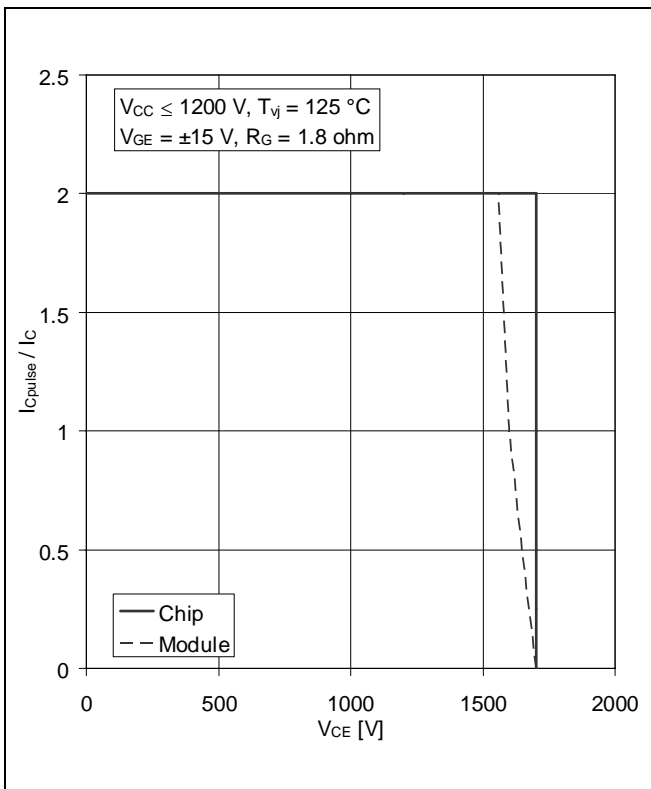

Fig. 11 Turn-off safe operating area (RBSOA)

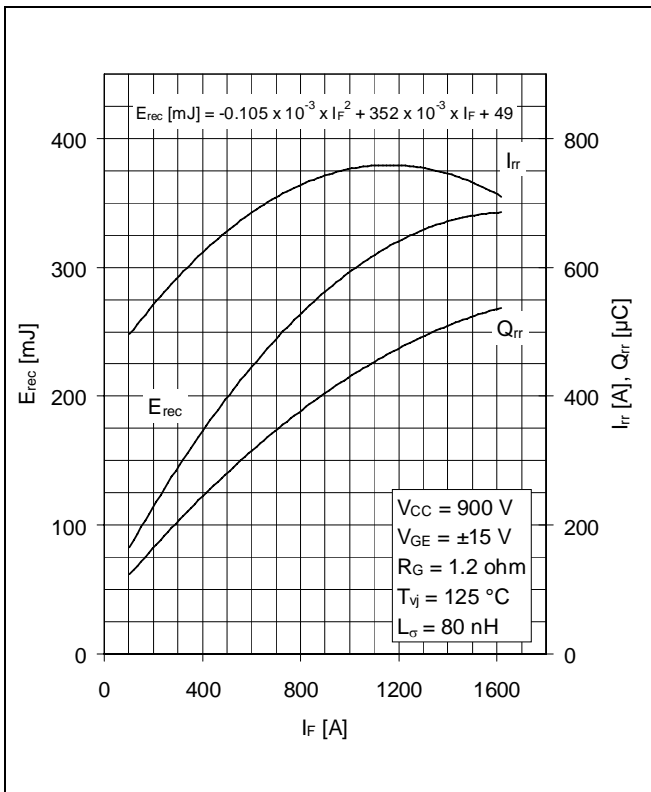

Fig. 12 Typical reverse recovery characteristics vs forward current

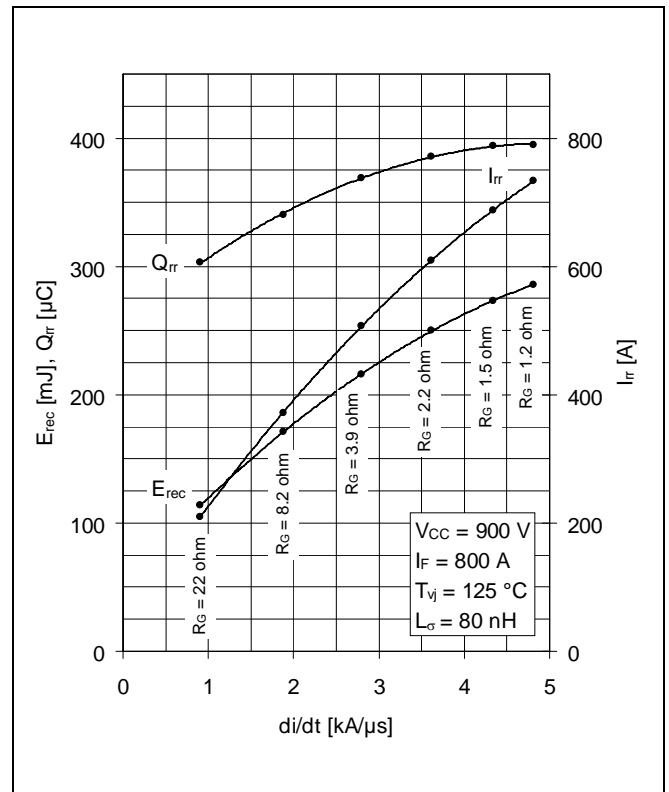

Fig. 13 Typical reverse recovery characteristics vs di/dt

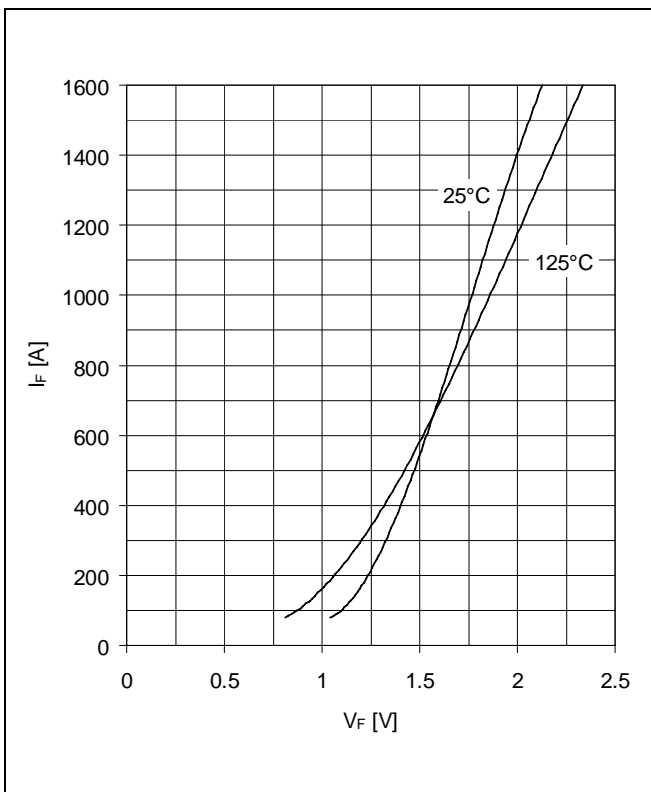

Fig. 14 Typical diode forward characteristics, chip level

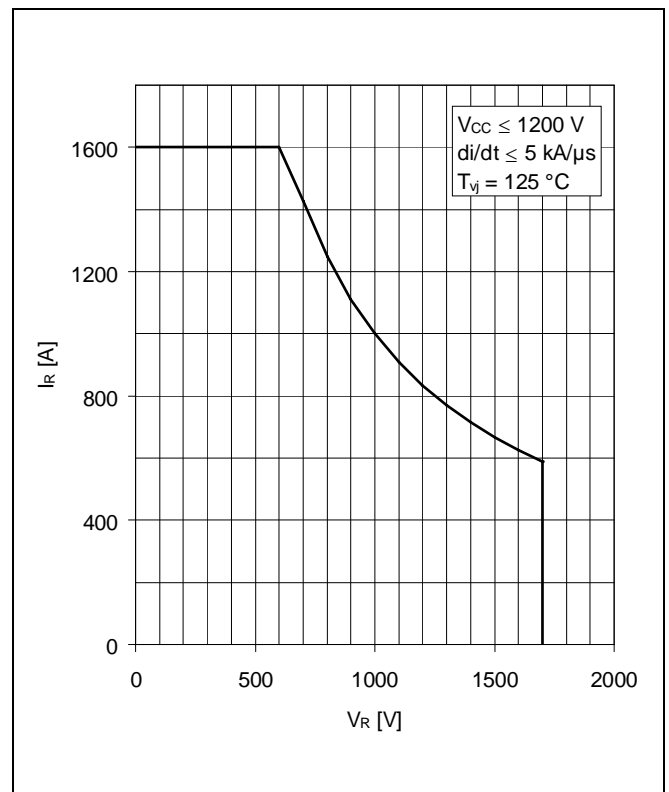

Fig. 15 Safe operating area diode (SOA)

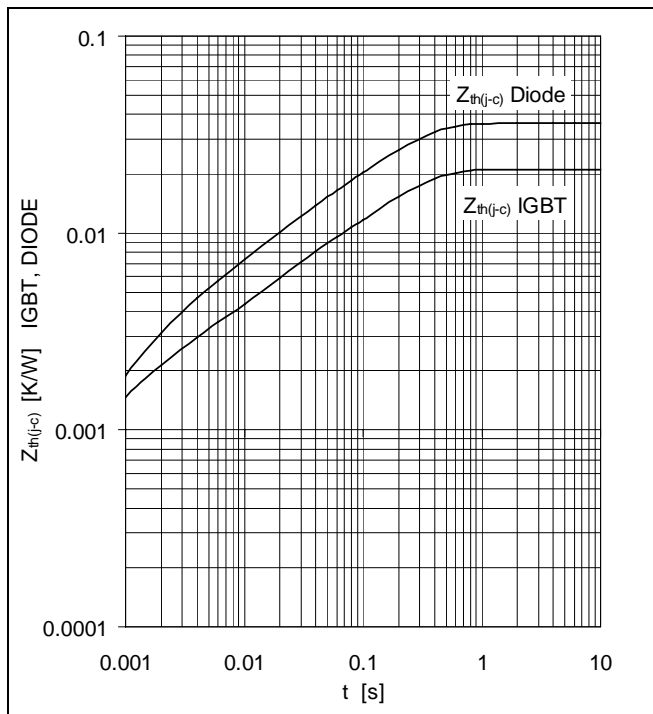

Fig. 16 Thermal impedance vs time

Analytical function for transient thermal impedance:

$$Z_{th(j-c)}(t) = \sum_{i=1}^n R_i (1 - e^{-t/\tau_i})$$

	i	1	2	3	4	
IGBT	R _i (K/kW)	15.2	3.6	1.49	0.74	
	τ _i (ms)	202	20.3	2.01	0.52	
DIODE	R _i (K/kW)	25.3	5.78	2.6	2.52	
	τ _i (ms)	210	29.6	7.01	1.49	

Related documents:

- 5SYA 2042 Failure rates of HiPak modules due to cosmic rays
- 5SYA 2043 Load - cycle capability of HiPaks
- 5SYA 2045 Thermal runaway during blocking
- 5SYA 2053 Applying IGBT
- 5SYA 2058 Surge currents for IGBT diodes
- 5SYA 2093 Thermal design of IGBT modules
- 5SYA 2098 Paralleling of IGBT modules
- 5SZK 9111 Specification of environmental class for HiPak Storage
- 5SZK 9112 Specification of environmental class for HiPak Transportation
- 5SZK 9113 Specification of environmental class for HiPak Operation (Industry)
- 5SZK 9120 Specification of environmental class for HiPak

We reserve all rights in this document and in the subject matter and illustrations contained therein. Any reproduction, disclosure to third parties or utilization of its contents - in whole or in parts - is forbidden without prior written consent. Copyright 2020 Hitachi Powergrids. All rights reserved.