



---

ABB INDUSTRIAL DRIVES

# ACS880+N5350 Cooling Tower Direct Drive

## User's guide



*Page intentionally left blank*



# ACS880+N5350 CTDD

---

## User's guide

Table of contents



Safety



*Page intentionally left blank*



# Table of Contents

---

## Safety

Contents of this chapter .....	7
Use of warnings and notes: .....	7
General safety in installation, start-up and maintenance .....	7
Electrical safety in installation, start-up and maintenance .....	9
Electrical safety precautions .....	9
Additional instructions and notes .....	9
Grounding .....	10
General safety in operation .....	10
Additional instructions for permanent magnet motor drives .....	11

## Introduction to the manual

Purpose of the manual .....	13
-----------------------------	----

## Product Familiarization

Overview .....	15
Usage .....	15

## Installation and Power Wiring

Motor Connections .....	16
Protecting motor insulation and bearings .....	16

## Connection Diagrams

ACS880+N5350 CTDD 2-Wire Operating Mode Example .....	18
ACS880+N5350 CTDD 3-Wire Operating Mode Example .....	20
Motor Contactor or Shorting Contactor Examples .....	22

## Control Wiring

Motor Thermostat .....	24
Digital Inputs .....	24
Analog Inputs .....	27
ACS880+N5350 CTDD Relay Outputs .....	28
ACS880+N5350 CTDD Analog Outputs .....	28

## Operating Modes

2-Wire Operating Mode (Default) .....	31
3-Wire Operating Mode .....	32
Process Control (PID) Operating Mode .....	33
Fieldbus Operating Mode .....	34

## Additional Setup

Trickle Current Heating .....	38
Trickle Current Power .....	39
Critical Speed Function .....	40
De-Ice Function .....	40
Advanced Drive Settings .....	40

## Applying Power

## Startup Assistant

Startup Assistants for the ACS880+N5350 CTDD .....	44
Drive Assistant Cooling Tower Setup .....	49

**Parameters**

ACS880 CTDD Parameters ..... 55  
Summary of parameter groups ..... 56  
Parameter listing ..... 57

**Fault Tracing**

Warnings and Faults ..... 85  
Warning/Fault History ..... 85  
Warning Messages ..... 86

**Modbus RTU Setup**

ACS880 CTDD ..... 88

**Ethernet/IP Setup**

ACS880 CTDD ..... 94

**Modbus TCP Setup**

ACS880 CTDD ..... 99

## 1

# Safety

---

## Contents of this chapter

This chapter contains the safety instructions which you must obey when you install, start-up, operate and do maintenance work on the drive. If you ignore the safety instructions, injury, death or damage can occur.

## Use of warnings and notes:

Warnings tell you about conditions which can cause injury or death, or damage to the equipment. They also tell you how to prevent the danger. Notes draw attention to a particular condition or fact, or give information on a subject.

**WARNING!**

Electricity warning warns hazard from electricity which can cause physical injury and/or damage to the equipment.

---

**WARNING!**

General warning warns about conditions, other than those caused by electricity, which can result in physical injury and/or damage to the equipment.

---

**WARNING!**

Electrostatic sensitive devices warning warns of electrostatic discharge which can damage the equipment.

---

## General safety in installation, start-up and maintenance

These instructions are for all personnel who do work on the drive.

**WARNING!**

Obey these instructions. If you ignore them, injury or death, or damage to the equipment can occur.

---

- Keep the drive in its package until you install it. After unpacking, protect the drive from dust, debris and moisture.
  - Use the required personal protective equipment: safety shoes with metal toe cap, safety glasses, protective gloves and long sleeves, etc. Some parts have sharp edges.
- 



## 8 Safety

- Lift a heavy drive with a lifting device. Use the designated lifting points. See the dimension drawings in the *Hardware manuals*.
- Be careful when handling a tall module. The module overturns easily because it is heavy and has a high center of gravity. Whenever possible, secure the module with chains. Do not leave an unsupported module unattended especially on a sloping floor.



- Beware of hot surfaces. Some parts, such as heatsinks of power semiconductors, and brake resistors, remain hot after disconnection of the electrical supply.
- Vacuum the area around the drive before the start-up to prevent the drive cooling fan from drawing the dust inside the drive.
- Make sure that debris from drilling, cutting and grinding does not enter the drive during the installation. Electrically conductive debris inside the drive may cause damage or malfunction.
- Make sure that there is sufficient cooling. See the technical data section of the *Hardware manuals*.
- Before you apply voltage to the drive, make sure that all covers are in place. Do not remove the covers when voltage is applied.
- Before you adjust the drive operation limits, make sure that the motor and all driven equipment can operate throughout the set operation limits.
- Before you activate the automatic fault reset or automatic restart functions of the drive control program, make sure that no dangerous situations can occur. These functions reset the drive automatically and continue operation after a fault or supply break. If these functions are activated, the installation must be clearly marked as defined in IEC/EN/UL 61800-5-1, subclause 6.5.3, for example, “THIS MACHINE STARTS AUTOMATICALLY.”
- The maximum number of drive power-ups is five in ten minutes. Too frequent power-ups, can damage the charging circuit of the DC capacitors. If you need to start or stop the drive, use the control panel or commands through the I/O terminals or fieldbus of the drive.
- If you have connected safety circuits to the drive (for example, Safe torque off or emergency stop), validate them at start-up. See separate instructions for the safety circuits.
- Beware of hot air exiting from the air outlets.
- Do not cover the air inlet or outlet when the drive is running.

### Note:

- If you select an external source for the start command, and it is on, the drive will start immediately after fault reset unless you configure the drive for pulse start. See the *ACS880 Firmware manual*.
- If the drive is in remote control mode, you cannot stop or start the drive with the control panel.





- Only authorized personnel are allowed to repair a malfunctioning drive.

## Electrical safety in installation, start-up and maintenance

### ■ Electrical safety precautions

These electrical safety precautions are for all personnel who perform work on the drive, motor cable or motor.



#### WARNING!

Obey these instructions. If you ignore them, injury or death, or damage to the equipment can occur.

If you are not a qualified electrical professional, do not do installation or maintenance work.

Go through these steps before you begin any installation or maintenance work.

1. Clearly identify the work location and equipment.
2. Disconnect all possible voltage sources. Make sure that re-connection is not possible. Lock out and tag out.
  - Open the main disconnecting device of the drive.
  - If you have a permanent magnet motor connected to the drive, disconnect the motor from the drive with a safety switch or by other means.
  - Disconnect all dangerous external voltages from the control circuits.
  - After you disconnect power from the drive, always wait 5 minutes to let the intermediate circuit capacitors discharge before you continue.
3. Protect any other energized parts in the work location from accidental contact.
4. Take special precautions when close to uninsulated conductors.
5. Measure that the installation is de-energized. Use a quality multimeter with impedance of at least 1M $\Omega$ .
  - Before and after measuring the installation, verify the operation of the multimeter on a known voltage source.
  - Make sure that the voltage between the drive input power terminals (L1, L2, L3) and the grounding (PE) busbar is zero.
  - Make sure that the voltage between the drive output terminals (T1/U, T2/V, T3/W) and the grounding (PE) busbar is zero.
  - Make sure that the voltage between the drive DC terminals (UDC+ and UDC-) and the grounding (PE) terminal is zero.

**Note:** If cables are not connected to the drive DC terminals, measuring the voltage from the DC terminal screws can give incorrect results.
6. Install temporary grounding as required by the local regulations.
7. Ask for a permit to work from the person in control of the electrical installation work.

### ■ Additional instructions and notes



#### WARNING!

Obey these instructions. If you ignore them, injury or death, or damage to the equipment can occur. If you are not a qualified electrical professional, do not do installation or maintenance work.

- Make sure that the electrical power network, motor/generator, and environmental conditions agree with the drive data.
- Do not perform insulation or voltage withstand tests on the drive.



## 10 Safety

- If you have a cardiac pacemaker or other electronic medical device, keep away from the area near motor, drive, and the drive power cabling when the drive is in operation. There are electromagnetic fields present which can interfere with the function of such devices. This can cause a health hazard.

### Notes:

- When the drive is connected to the input power, the motor cable terminals and the DC bus are at a dangerous voltage. The brake circuit, including the brake chopper (option +D150) and brake resistor (if installed) are also at a dangerous voltage. After disconnecting the drive from the input power, these remain at a dangerous voltage until the intermediate circuit capacitors have discharged.
- External wiring can supply dangerous voltages to the drive. Ensure all sources of power have been disconnected before performing service on the drive.
- The Safe torque off function does not remove the voltage from the main and auxiliary circuits. The function is not effective against deliberate sabotage or misuse.
- Do not install drive with EMC filter option +E200 or +E202 on an ungrounded network or high resistance grounded (over 30 ohms) network. Review the *Hardware manuals* and the *EMC filter and ground-to-phase varistor disconnecting instructions* when connecting to the line supply. Take special considerations when connecting to ungrounded or high resistance grounded network.

## Printed circuit boards



### WARNING!

Use a grounding wristband when you handle printed circuit boards. Do not touch the boards unnecessarily. The boards contain components sensitive to electrostatic discharge.

---

## ■ Grounding

These instructions are intended for all who are responsible for the grounding of the drive.

---



### WARNING!

Obey these instructions. If you ignore them, injury or death, or equipment malfunction can occur, and electromagnetic interference can increase. If you are not a qualified electrical professional, do not do grounding work.

---

- Always ground the drive, the motor and adjoining equipment. This is necessary for the personnel safety.
- Make sure that the conductivity of the protective earth (PE) conductors is sufficient and that other requirements are met. See the electrical planning instructions of the drive. Obey the applicable national and local regulations.
- When using shielded cables, incorporate 360° grounding of the cable shields at the cable entries to reduce electromagnetic emission and interference.
- In a multiple-drive installation, connect each drive separately to the protective earth (PE) busbar of the power supply.

## General safety in operation

These instructions are for all personnel that operate the drive.

---



**WARNING:** Ignoring the following instructions can cause physical injury or death, or damage to the equipment

---

---

- If you have a cardiac pacemaker or other electronic medical device, keep away from the area near motor, drive, and the drive power cabling when the drive is in operation. There are electromagnetic fields present which can interfere with the function of such devices. This can cause a health hazard.
- Give a stop command to the drive before you reset a fault. If you have an external source for the start command and the start is on, the drive will start immediately after the fault reset, unless you configure the drive for pulse start. See the *ACS880 Firmware manual*.
- Before you activate the automatic fault reset or automatic restart functions of the drive control program, make sure that no dangerous situations can occur. These functions reset the drive automatically and continue operation after a fault or supply break. If these functions are activated, the installation must be clearly marked as defined in IEC/EN/UL 61800-5-1, subclause 6.5.3, for example, “THIS MACHINE STARTS AUTOMATICALLY”.

**Notes:**

- The maximum number of drive power-ups is five in ten minutes. Too frequent power-ups can damage the charging circuit of the DC capacitors. If you need to start or stop the drive, use the control panel or commands through the I/O terminals of the drive.
- If the drive is in remote control mode, you cannot stop or start the drive with the control panel.

## Additional instructions for permanent magnet motor drives

### ■ Safety in installation, start-up, maintenance

These are additional warnings concerning permanent magnet motor drives. The other safety instructions in this chapter are also valid.



**WARNING!**

Obey these instructions. If you ignore them, injury or death, or damage to the equipment can occur. If you are not a qualified electrical professional, do not do installation or maintenance work.

---

- Do not do work on the drive when a rotating permanent magnet motor is connected to it. A rotating permanent magnet motor energizes the drive including its input and output power terminals.

Before installation, start-up and maintenance work on the drive:

- Stop the drive and motor.
- Ensure that there is no voltage on the drive power terminals using steps 1, 2, or both:
  1. Disconnect the motor from the drive with a safety switch or by other means. Shorting and isolation contactors can be used to short the motor leads and isolate the drive from the motor. (Refer to *page 22*) Measure that there is not voltage present on drive input or output terminals (L1, L2 L3, U/T1, V/T2, W/T3, UDC+, UDC-).
  2. Wind can rotate the motor and generate electric potentials. Ensure that the motor is not rotating or is disconnected from the drive during service. Shorting and isolation contactors can be used to short the motor leads and isolate the drive from the motor. (Refer to *page 22*)
- Perform the steps in section ■ *Electrical safety precautions*.



## 12 Safety

- Install temporary grounding to the drive output terminals (T1/U, T2/V, T3/W). Connect the output terminals together as well as to the PE.

During the start-up:

- Make sure that the motor cannot run overspeed, including if driven by the load. Motor overspeed causes overvoltage that can damage or destroy the capacitors in the intermediate circuit of the drive.

### ■ Safety in operation



#### **WARNING!**

Make sure that the motor cannot run overspeed, including if driven by the load. Motor overspeed causes overvoltage that can damage or destroy the capacitors in the intermediate circuit of the drive.

ACS880+N5350 Cooling Tower Direct Drive (CTDD) with serial number beginning with '2' are shipped with quantity two of the following labels. It is recommended that these be placed by the drive terminals where connections to the motor are made, and on the outside of the enclosure near the disconnect. Label part number is 3AXD5000032478.

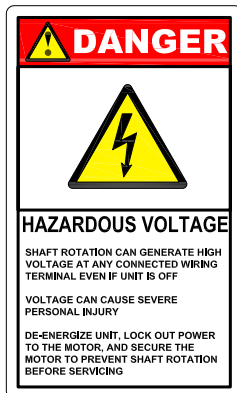



# Introduction to the manual

---

## Purpose of the manual

An ABB ACS880 drive's firmware can be augmented for specific applications by building onto the primary control program. In this case, the +N5350 option code in the drive Typecode indicates that this drive contains special software above and beyond the primary control program to control a Baldor permanent magnet motor in a cooling tower application.

This manual provides information specific to the ACS880+N5350 CTDD and is supplemental to the primary hardware and firmware manual of the ACS880 drive. Refer to the available manuals below as a primary source of warnings, safety, basic installation, start-up, operation and servicing.

The +N5350 control is designed specifically for Baldor-Reliance Interior Permanent Magnet Cooling Tower Motor Control. Control is intended for operating cooling tower fans through a 10:1 variable speed range as well as providing torque control to minimize mechanical stress on the system.

For technical assistance, contact your local ABB representative. Before calling, review the troubleshooting section in the [Hardware manuals](#) and the [ACS880 Firmware manual](#). You will be asked for the drive model number or catalog number that is located on the nameplate along with the drive serial number.

## Related manuals:

List of hyperlinks to product manuals and guides	Code (English)
ACS880-01 hardware manual	3AUA0000078093
ACS880-07 hardware manual	3AUA0000105718
ACS880-31 hardware manual	3AXD50000045933
ACS880-34 hardware manual	3AXD50000035191
ACS880-37 hardware manual	3AXD50000020437
ACS880 firmware manual	3AUA0000085967
ACS880-01 drive module frames R1 to R9 for cabinet installation (options +P940 and +P944) supplement	3AUA0000145446
ACS880-01 assembly drawings for cable entry boxes of IP21 frames R5 to R9	3AUA0000119627
ACx-AP-x assistant control panel's user's manual	3AUA0000085685
ACS880 frames R1 to R11 EMC filter and ground-to-phase varistor disconnecting instructions	3AUA0000125152
ACS880-11...,ACS880-31...,ACH580-31... and ACQ580-31...+C135 drives with flange mounting kit supplement	3AXD50000349838
Drive composer start-up and maintenance PC tool user's manual	3AUA0000094606
EMC filter and ground-to-phase varistor disconnecting instructions	3AXD50000306749
Flange mounting kit quick installation guide for ACS880-01 frames R1 to R3	3AXD50000026158
Flange mounting kit quick installation guide for ACS880-01 frames R4 to R5	3AXD50000026159
Flange mounting kit quick installation guide for ACS880-01 frames R6 to R9	3AXD50000019099
Flange mounting kit quick installation guide for ACS880-31 frame R3	3AXD50000181506
Flange mounting kit quick installation guide for ACS880-31 frame R6 and R8	3AXD50000133611
Capacitor reforming instruction	3BFE64059629
ACS880-01 drives recycling instructions and environment information	3AUA0000149383
ACS880-01 quick installation and startup guide	3AXD50000754618
ACS880-31 quick installation and startup guide	3AXD50000803033
FENA-01 /-11/-21 Ethernet adapter module user's manual	3AUA0000093568
FEIP-21 Ethernet/IP adapter module user's manual	3AXD50000158621
FSCA-01 RS485 adapter module user's manual	3AUA0000109533
FMBT-21 Modbus/TCP adapter module user's manual	3AXD50000158607

Contact your local ABB office for the latest firmware and manuals for your drive product. You can find manuals and other product documents in PDF format at [library.abb.com](http://library.abb.com). For manuals not available in the Document library, contact your local ABB representative.

The code below opens an online listing of the manuals applicable to this product.



ACS880-01 manuals

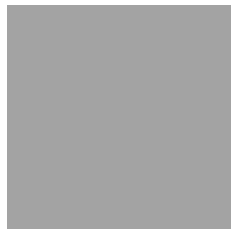

ACS880-04 manuals

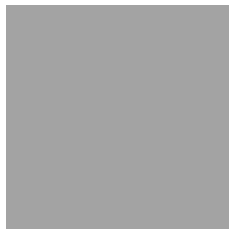

ACS880-07 manuals

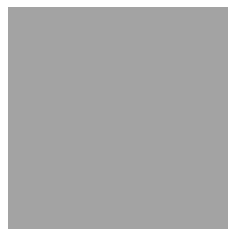

ACS880-31 manuals

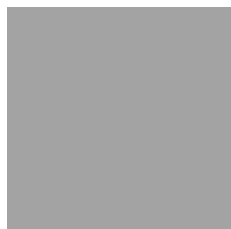

ACS880-34 manuals

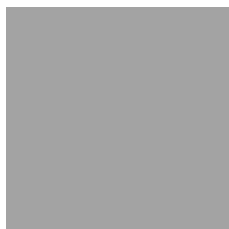

ACS880-37 manuals



# Product Familiarization

---

## Overview

The ACS880+N5350 CTDD is designed to provide variable speed control for a cooling tower fan. This is accomplished much like traditional variable frequency drives, but with unique capabilities specific to the type of motor used and the type of application for the control being employed.

The +N5350 control is designed specifically for Baldor Interior Permanent Magnet Cooling Tower Motor Control. Control is intended for operating cooling tower fans through a 10:1 variable speed range as well as providing torque control to minimize mechanical stress on the system. The motor drive systems are designed for direct drive applications and eliminate the need for right angle gearboxes. ACS880+N5350 CTDD are available in both 6-pulse and Ultra-Low Harmonic configurations.

## Usage

The ACS880+N5350 CTDD can only be used with a Baldor RPM AC Interior Permanent Magnet Cooling Tower Motor. If the motor you need to control is of any other type, contact your local ABB office for support.

---

# 4

## Installation and Power Wiring

---

Before reviewing the sections that follow, read both the *Quick installation and start-up guide* and *Hardware manual*. These documents provide specifics on installing, wiring, and starting the drive in a safe and efficient manner. The information that follows is in addition to the *Hardware manual* and quick guide information.

### Motor Connections

In order to make the startup process smoother, record both the drive serial number and the motor serial number, along with the back EMF and all other motor data as identified under *Motor Data Settings*.

The wiring between the drive and the motor must consist of 3 wires plus an insulated ground routed in the same conduit or symmetrically shielded VFD cable. The ground wire must be continuous and terminated in the motor connection box as well as on the drive ground terminal. The output power wiring is terminated in the drive on terminals T1, T2, and T3. See *Figure 4-1 Motor Connections*.

Note that a direct connection between the drive and motor without any other device is an acceptable means of controlling the motor but local safety regulations may require the use of a motor isolation switch or contactor to provide a way to ensure that power is removed from the motor prior to servicing the cooling tower. See *Connection Diagrams on page 18*.

The following warnings, including the warnings in *Chapter 1*, help identify important considerations when using a permanent magnet motor. Please review these warnings carefully before operating the permanent magnet cooling tower motor.



**WARNING:** Motor circuit may have high voltage present whenever AC power is applied, even when motor is not rotating. Electrical shock can cause serious or fatal injury.

**WARNING:** RPM AC permanent magnet motors can induce voltage and current in the motor leads by rotating the motor shaft. Electrical shock can cause serious or fatal injury. Therefore, do not couple the load to the motor shaft until all motor connections have been made. During any maintenance inspections, be sure the motor shaft will not rotate.

**WARNING:** If an output motor isolation contactor is installed, the control must be disabled for at least 200mSec before the contactor is opened. If the contactor is opened while the control is supplying voltage and current to the motor, the control may be damaged. Before the control is enabled, the contactor must be closed for at least 200mSec.

**WARNING:** If an output motor isolation disconnect switch is installed, the control must be disabled for at least 200mSec before the switch is opened. If the switch is opened while the control is supplying voltage and current to the motor, the control may be damaged. Before the control is enabled, the switch must be closed for at least 200mSec.

---

### Protecting motor insulation and bearings

The ACS880+N5350 CTDD employs IGBT inverter technology. The drive output comprises of very high dv/dt pulses of approximately the drive DC bus voltage. The pulse voltage can almost double at the motor terminals depending

---



on the attenuation and reflection properties of the motor cable and terminals. This can cause additional stress on the motor and motor cable insulation. Modern variable speed drives with their fast rise times and high switching frequencies can generate current that flows through the motor bearings that can erode the bearing races and rolling elements. Optional dv/dt filters protect the motor insulation systems and reduce bearing currents while common mode filters can reduce bearing currents. Insulated non-drive-end bearings can protect the motor from bearing currents. The Baldor-Reliance Permanent Magnet Cooling Tower motors are available with optional grounding brushes and insulated bearings which can reduce bearing currents.

Figure 4-1 Motor Connections

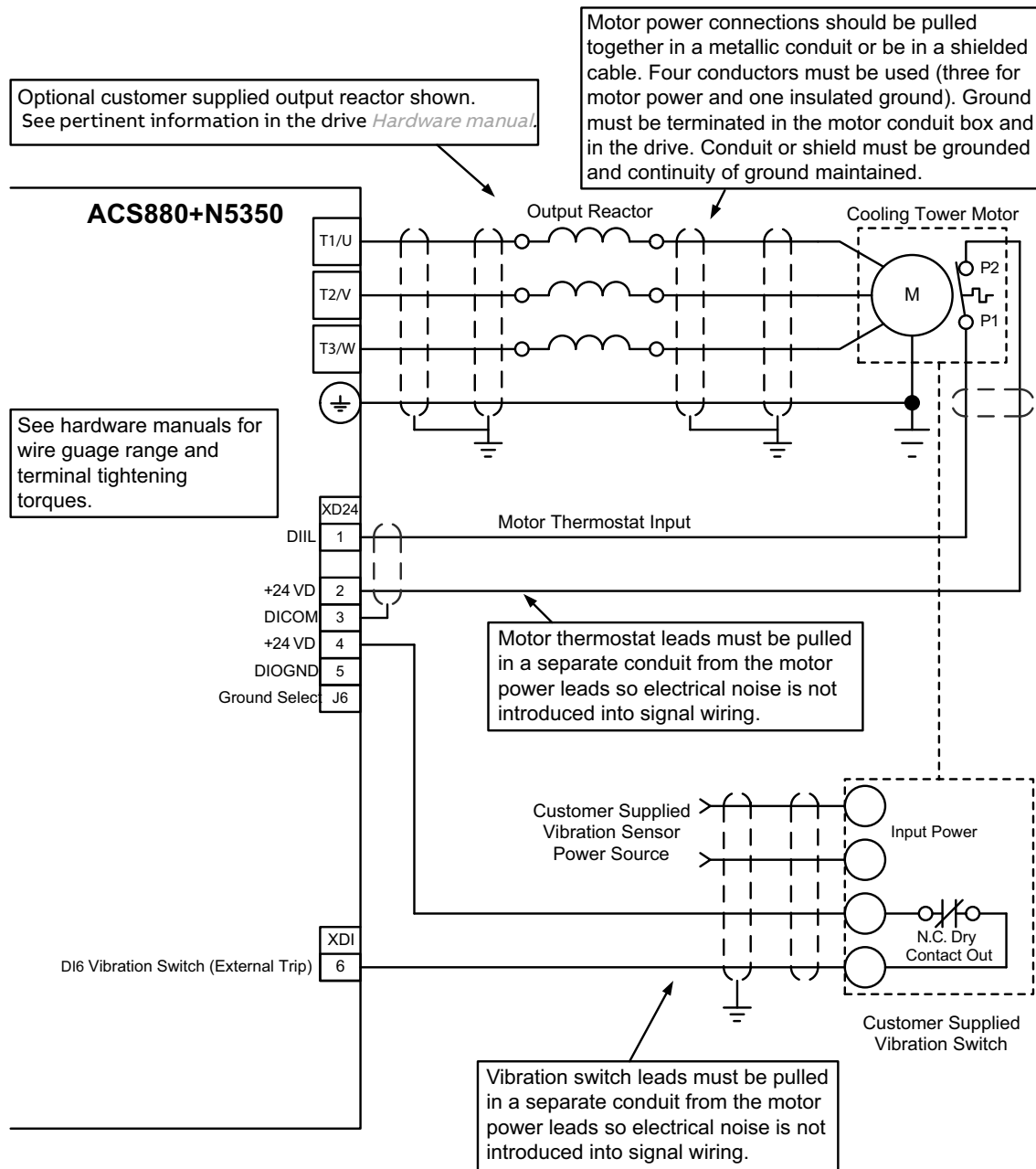



## Connection Diagrams

---

It is ultimately the user's responsibility to insure that the ACS880+N5350 CTDD is installed in a manner that will provide a safe and trouble-free system that meets local and national safety and electrical codes. The information provided in this section is not intended to specifically dictate how the ACS880+N5350 CTDD is to be wired or even to imply that all safety factors have been considered since these may vary from one installation to another. These diagrams are provided so that the installer can recognize several possible ways the drive can be connected based upon the 2-Wire Operating Mode as well as the 3-Wire Operating Mode.

The devices external to the ACS880+N5350 CTDD and the RPM AC Cooling Tower Motor depicted in the following diagrams are considered user supplied unless they are ordered as a packaged drive from ABB or as separate line items. Contact your local ABB representative for support regarding the additional equipment or a packaged drive.

Below is a brief description of some different operating modes. For additional information see Chapter 7.

### ACS880+N5350 CTDD 2-Wire Operating Mode Example

The 2-Wire Operating Mode is provided for those customers that wish to control their cooling tower fan using what is traditionally called "2-Wire Control". This method of control utilizes a single "Off – On" selector switch to stop / run the fan. On power loss to the drive, the drive will restart automatically when power is restored.

### Manual Motor Disconnect Switch

This diagram depicts an example using the 2-Wire Operating Mode, along with a manual disconnect switch between the drive and the motor. The disconnect switch used in this diagram is a 3 position switch. One position is used when the fan motor is being controlled by the ACS880+N5350 CTDD. The neutral position disconnects the fan motor from the drive and a third position shorts the motor leads together to prohibit hazardous voltages from being present on the motor leads when it is disconnected from the drive should the fan rotate. This could occur since the motor has permanent magnets in its rotor thus giving it the characteristics of a generator when not connected to a drive. This shorted position will cause the motor to resist windmilling. Note that it is required to provide an auxiliary contact on the disconnect switch that is open any time the motor is not connected to the drive. This contact needs to be of the "Late Make / Early Break" style such that the contacts on the auxiliary open before the power contacts open. Additionally, when the disconnect switch is closed, the power contacts of the disconnect switch must close prior to the closure of the auxiliary contact.

---

#### **WARNING!**

Shorting the motor leads produces a locking torque at the motor shaft. Applying locking torque for long periods of time may result in motor bearing brinelling from ambient vibration. It is recommended that the motor not be left in the locked condition for extended periods of time.

---

Figure 5-1 ACS880+N5350 CTDD 2-Wire Manual Motor Disconnect Switch

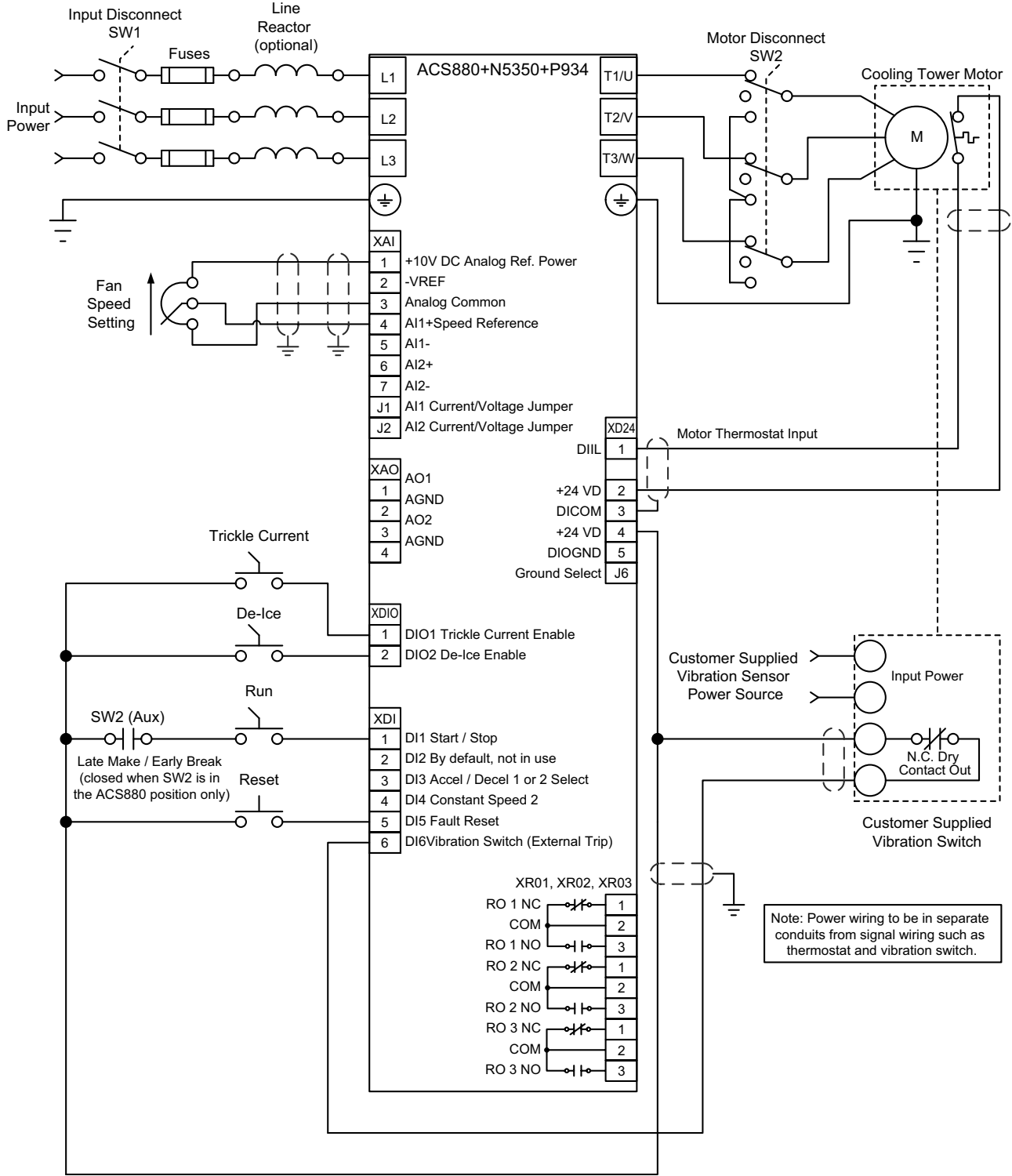

## 20 Connection Diagrams

Below is a brief description of some different operating modes.

### ACS880+N5350 CTDD 3-Wire Operating Mode Example

The 3-Wire Operating Mode is provided for those customers that wish to control their cooling tower fan using what is traditionally called “3-Wire Control”. This method of control utilizes a momentary normally open “Start” pushbutton to run the fan and a momentary normally closed “Stop” push button to stop the fan. On power loss to the drive control, the stop circuit will open causing the drive to stop. Upon power restoration the “start” pushbutton will need to be pressed again to start the drive.

### Manual Motor Disconnect Switch

This diagram depicts an example using the 3-Wire Operating Mode, along with a manual disconnect switch between the drive and the motor. The disconnect switch used in this diagram is a 3 position switch. One position is used when the fan motor is being controlled by the ACS880+N5350 CTDD. The neutral position disconnects the fan motor from the drive and a third position shorts the motor leads together to prohibit hazardous voltages from being present on the motor leads when it is disconnected from the drive should the fan rotate. This could occur since the motor has permanent magnets in its rotor thus giving it the characteristics of a generator when not connected to a drive. This shorted position will cause the motor to resist windmilling. Note that it is required to provide an auxiliary contact on the disconnect switch that is open any time the motor is not connected to the drive. This contact needs to be of the “Late Make / Early Break” style such that the contacts on the auxiliary open before the power contacts open. Additionally, when the disconnect switch is closed, the power contacts of the disconnect switch must close prior to the closure of the auxiliary contact.

---

#### **WARNING!**

Shorting the motor leads produces a locking torque at the motor shaft. Applying locking torque for long periods of time may result in motor bearing brinelling from ambient vibration. It is recommended that the motor not be left in the locked condition for extended periods of time.

---

Figure 5-2 ACS880+N5350 CTDD 3-Wire Manual Motor Disconnect Switch

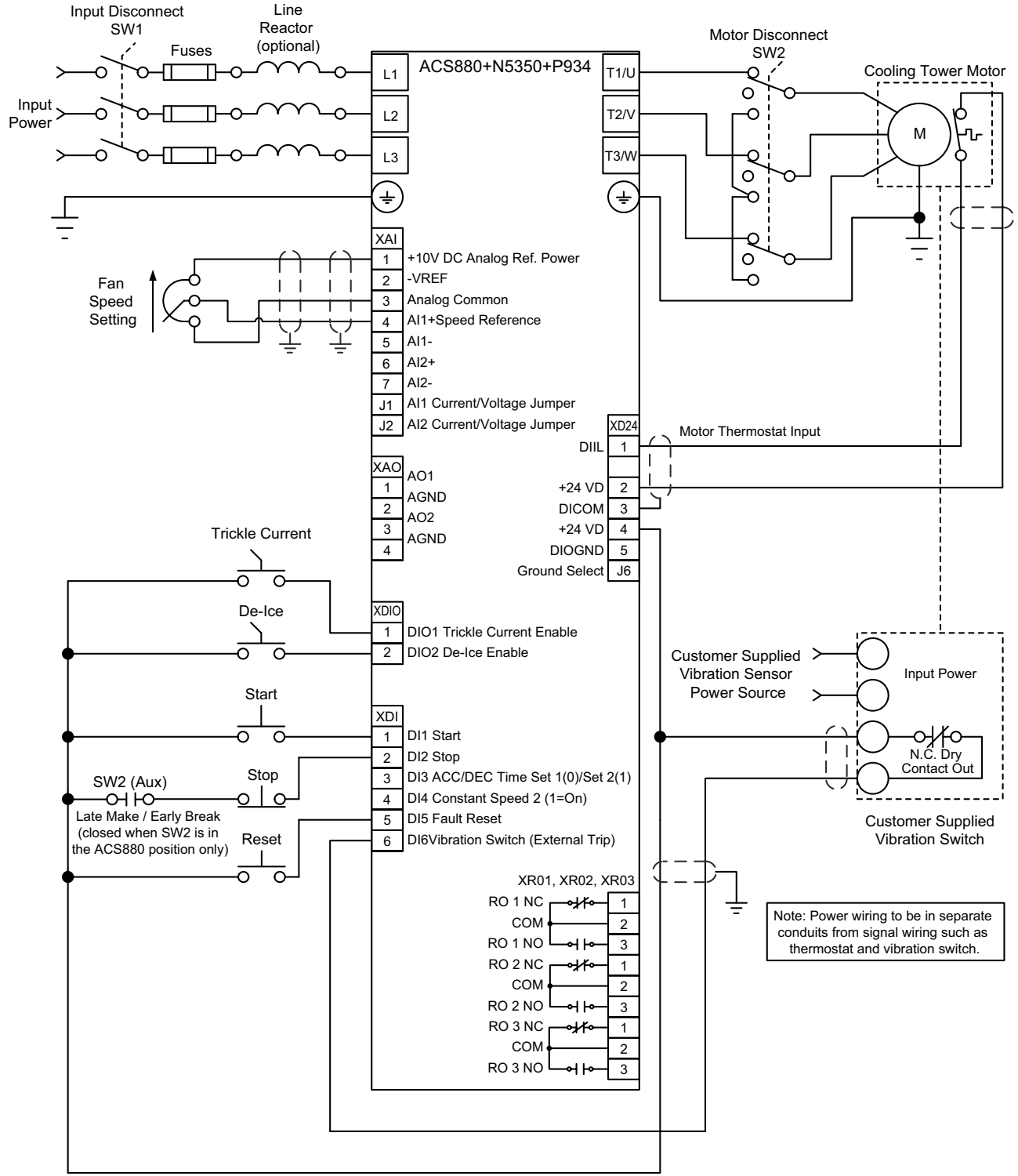

## Motor Contactor or Shorting Contactor Examples

The following configurations are intended as examples for providing a manual motor disconnect or a power off fail safe shorting contactor. These approaches can be used independent of the drive starting mode or reference source and are not tied directly to the drive controller. *Figure 5-3 on page 23* depicts the preferred usage of a shorting contactor and a motor disconnect when used with the ACS880+N5350 CTDD.

### Manual Motor Disconnect Switch

The motor disconnect should be located remotely from the drive panel, within site of the direct drive RPM AC motor and driven load. This is in compliance with National Electric Code Sections 420.102 to 430.109. This switch should only be shorted after the ACS880+N5350 CTDD has been powered down or deactivated and the drive has come to a full stop (ie., drive modulation has stopped).

### Shorting Contactor

The intent of the Shorting Contactor is to provide one position (open) that is used when the fan is being run by the ACS880+N5350 CTDD. This is the normal power on state. The other power off position (closed) shorts the motor leads together.

For both the options, the position that shorts the leads together is used to prohibit hazardous voltages from being present on the motor leads when it is disconnected from the drive should the fan rotate. This could occur since the motor includes permanent magnets in its rotor thus giving it the characteristics of being a generator. Another benefit of this position is that it will cause the motor to resist wind-milling.

---

#### **WARNING!**

Shorting the motor leads produces a locking torque at the motor shaft. Applying locking torque for long periods of time may result in motor bearing brinelling from ambient vibration. It is recommended that the motor not be left in the locked condition for extended periods of time.

---

Figure 5-3 Motor Contactor Example

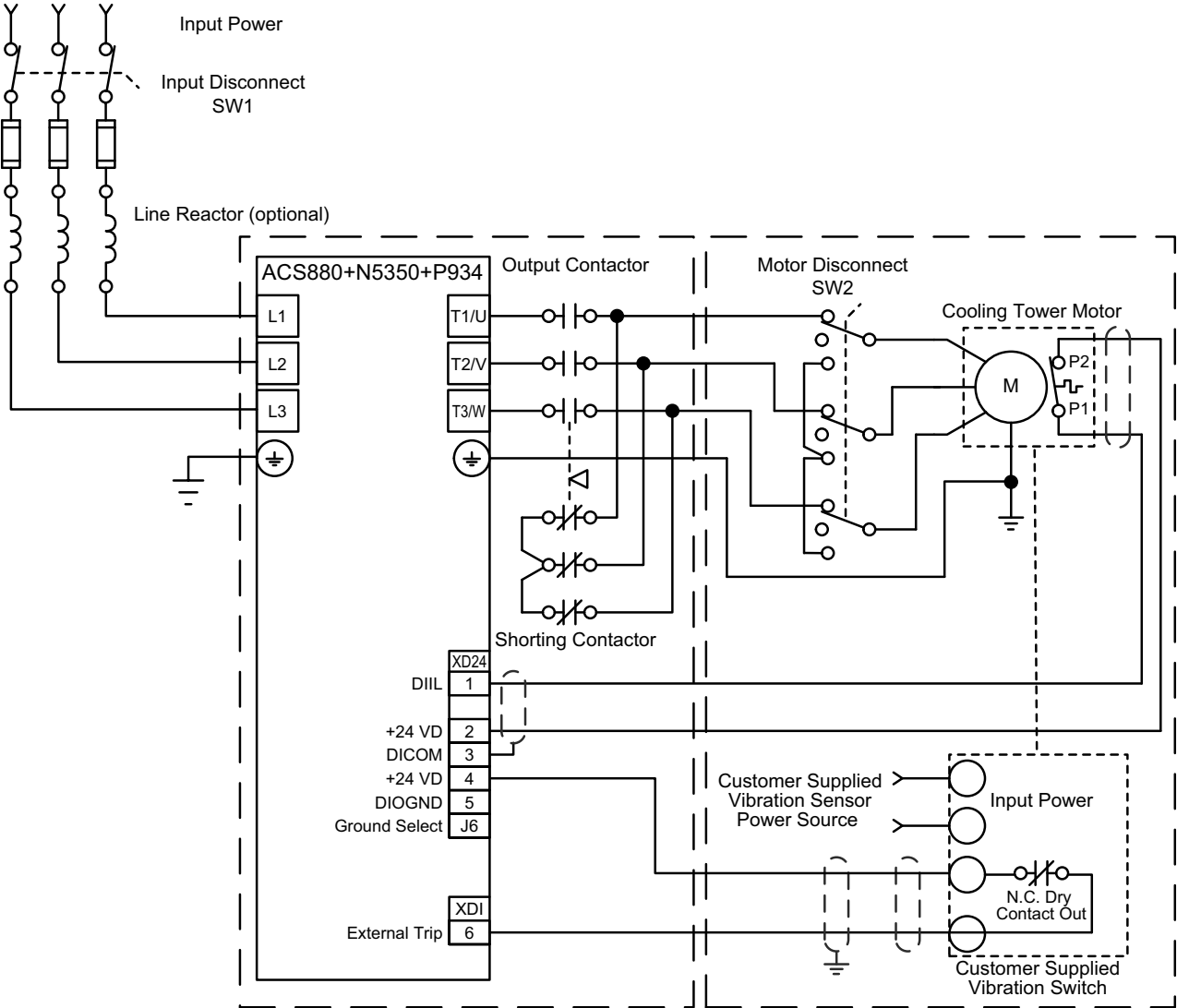

# 6

## Control Wiring

---

This section outlines the basics of the control wiring for the ACS880+N5350 CTDD. Unlike the standard ACS880, the ACS880+N5350 CTDD utilizes drive digital inputs, analog inputs, and digital outputs that are hard coded in firmware and cannot be modified. (Refer to Table 7-1 for more information.) Relay outputs, analog outputs, and I/O via extension modules can be modified via parameter selection.

### Motor Thermostat

RPM AC permanent magnet cooling tower motors are provided with thermostats in the stator windings that operate should the motor overheat. The thermostats are dry contacts designed to provide a normally closed (short) circuit when the motor is at a safe temperature and an open circuit should the motor overheat. Dedicated connections are provided for a series connection of these leads within the motor conduit box. All ACS880+N5350 CTDDs must be used with motor overtemperature sensing by correctly connecting the RPM AC cooling tower motor thermostats in series in the motor and then to the XD24-1 and XD24-2 terminals in the drive. The terminal designations for the motor thermostat connections are hard coded in firmware within the ACS880+N5350 CTDD and cannot be changed. The thermostat wiring between the motor and the control must be run in a conduit separate from the motor power leads to avoid noise related problems with the system.

### Digital Inputs

The ACS880+N5350 CTDD is supplied with 9 digital inputs for controlling the cooling tower fan. The connections for these digital inputs are made on terminals XD24, XDIO and XDI. XDIO-1 & 2 terminals are dedicated to trickle current and de-ice enable inputs and cannot be changed. XDI-6 is shipped as an External Trip input as discussed in the next section and it is recommended that this not be changed. The definitions of inputs on XDI-1 through XDI-5 are determined by the selected operating mode of the drive. Operating mode selection is used to easily select a pre-configured setup of the drive thus minimizing the programming required to commission the control. The available operating modes are described in *Chapter 7*.









The digital inputs are shipped as “active high” (NPN sinking) inputs. This means that an input signal is true when it is connected to +24 Volts. The drive’s internal 24V on XD24 can be used or an external supply can be used. Conversely, digital inputs DI1L and DI1-5 can be set up to be “active low” (PNP sourcing) inputs. In this case, an input signal is true when it is connected to 0 volts. This reference can use an external 24VDC supply or the internal supply on XD24.

Switch J6 on the control board is used to set up the digital inputs. If the input signals are to be controlled as “active high” (sinking) utilizing the internal 24VDC supply of the ACS880+N5350 CTDD, then no changes to the switch is required. To set up the digital inputs for other methods of control, see Table 6-1 for the alternate connections.

---



Table 6-1 Jumpers and Switches

Jumper/Switch	Description	Positions	
J1 (AI1)	Determines whether analog input AI1 is used as a current or voltage input.		Current (I)
			Voltage (U) (Default)
J2 (AI2)	Determines whether analog input AI2 is used as a current or voltage input.		Current (I) (Default)
			Voltage (U)
J3	Drive-to-drive link termination. Must be set to terminated position when the drive is the last unit on the link.		Bus is terminated (Default).
			Bus is not terminated.
J6	Common digital input ground selection switch. Determines whether DICOM is separated from DIOGND (i.e., common reference for digital inputs floats). See <i>Ground Isolation Diagram</i> .		DICOM and DIOGND connected (Default).
			DICOM and DIOGND separated.

## Notes:

- 1) Current [0(4)...20mA,  $R_{in} > 100\text{ohm}$ ] or voltage [0(2)...10 V,  $R_{in} > 200\text{kohm}$ ] input selected with J1. Change of setting requires reboot of control unit.
- 2) Current [0(4)...20mA,  $R_{in} > 100\text{ohm}$ ] or voltage [0(2)...10 V,  $R_{in} > 200\text{kohm}$ ] input selected with jumper J2. Change of setting requires reboot of control unit.
- 3) Total load capacity of these outputs is 4.8W (200mA / 24V) minus the power taken by DIO1 and DIO2.
- 4) 0 = open, 1 = closed

Figure 6-1 Ground Isolation Diagram

Ground isolation diagram

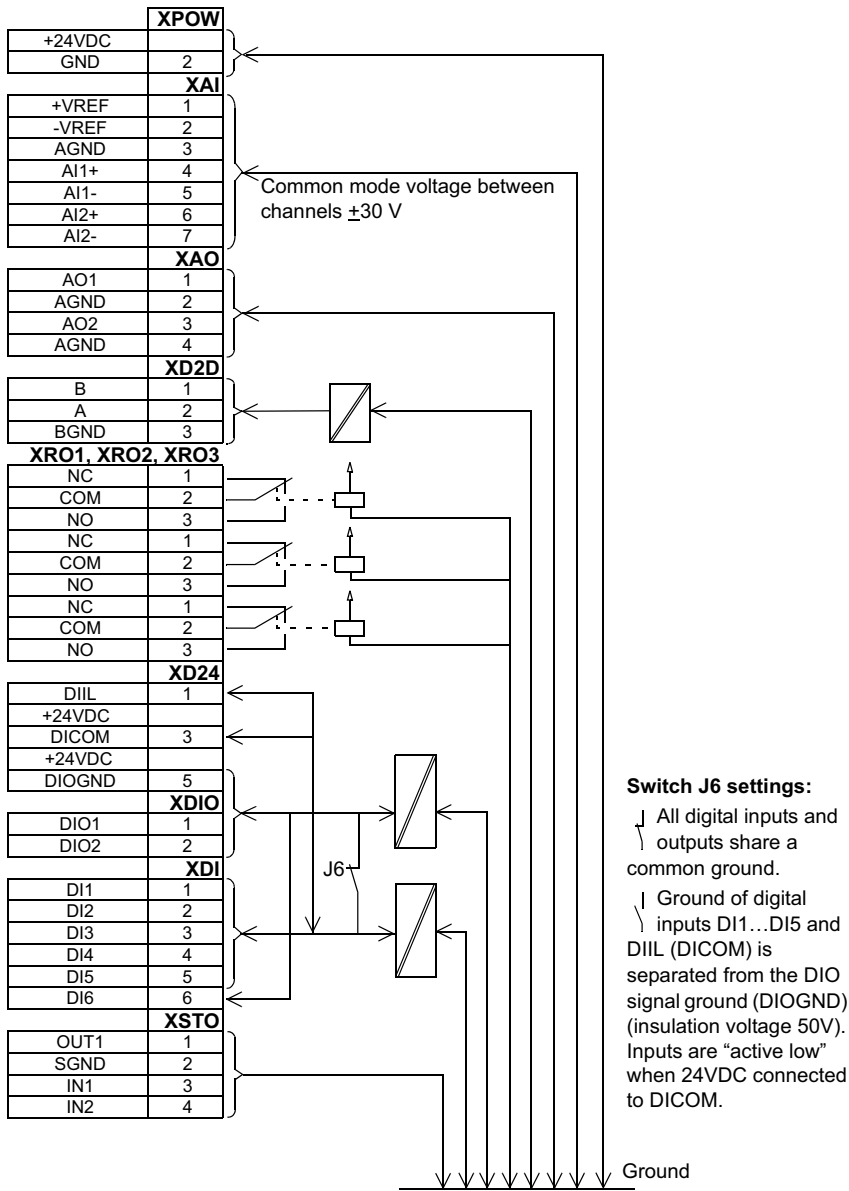

### Ramp Rate Selection

Input DI3 allows on-the-fly change to the acceleration and deceleration ramps of the fan. With this input off the fan will default to ramp times based on parameters 23.23 and 23.13. When the input is enabled the drive will follow ramp rates programmed in parameters 23.14 and 23.15.

DI3	Ramp times according to
0	Parameters 23.12 and 23.13
1	Parameters 23.14 and 23.15

## Vibration Switch / External Trip

An input is provided within the ACS880+N5350 CTDD that forces the drive to fault should the circuit connected to this input open. The intent for this input is to interrupt the operation of the drive should a customer supplied circuit open. A typical use for this input is the connection of a vibration sensor. The input is for a dry contact type device. Power is not supplied to the external device from the ACS880+N5350 CTDD and power from the device must not be supplied to the drive terminals. If the external device requires power for operation (e.g. 120VAC) then the installer must make provisions for this power from an alternate source.

Make the connections for the dry contacts of this external device between terminals XDI6 and XD24-4 when using the factory default active low configuration. Note that these terminal designations cannot be changed. The wiring for this device must be run in a conduit separate from the motor leads to avoid noise related problems with the system. The digital input has a 2kohm resistance with a maximum current of 5mA.

## Other Digital Inputs

Remaining digital inputs that may be required for operating the ACS880+N5350 CTDD are specific to the selected operating mode and are outlined in *Chapter 7*.

## Analog Inputs

Analog Input 1 is capable of accepting a single-ended voltage signal on terminal XAI4 with respect to the analog common on terminal XAI3. Should the customer desire to control the speed of the fan with a potentiometer, a +10V reference signal is provided on terminal XAI1 is provided. It is recommended that a potentiometer with a resistance value > 200kohm be used.

Analog inputs can be selected to receive either voltage or current signals. Both jumpers and parameters will need to be reviewed when selecting either. Refer to *Jumpers and Switches* above for J1 and J2 jumper settings. See parameter *12.15* (AI1 Unit Selection Command) to select Analog Input 1 as the speed reference and parameters *12.17* through *12.20* to customize the scaling and filtering for this input.

Note: For more information on setting the Analog Inputs refer to the *ACS880 Firmware manual*.

The terminal definition for the Analog Input connections is given in Figure 6-2 below.

Figure 6-2 Digital Input Connections.

XAI	Reference voltage and analog inputs	
1	+VREF	10 VDC , $R_L1 \dots 10 \text{ kohm}$
2	-VREF	-10 VDC , $R_L1 \dots 10 \text{ kohm}$
3	AGND	Ground
4	AI 1 +	Speed reference
5	AI 1 -	0(2)... 10 V, $R_{in} > 200 \text{ kohm}$
6	AI 2 +	By default not in use
7	AI 2 -	0(4)... 20 mA , $R_{in} > 200 \text{ kohm}$

Figure 6-2 is non-specific to operational mode. Refer to table on page 29 for specific information.

Table 6-2 provides the electrical and mechanical specifications for the drive's analog input.

Table 6-2 Analog Input 1 Technical Data

Reference voltage for analog inputs +VREF and -VREF (XAI:1)	Connector pitch 5 mm, wire size 2.5 mm <sup>2</sup>
	10V ±1% and -10V ±1%, R <sub>load</sub> 1...10kohm
Analog inputs AI1 (XAI:4...XAI:7) Current/voltage input mode selection by jumpers.	Connector pitch 5mm, wire size 2.5mm <sup>2</sup>
	Current input: -20...20mA, R <sub>in</sub> : 100ohm
	Voltage input: -10...10V, R <sub>in</sub> : > 200kohm
	Differential inputs, common mode range ±30V
	Sampling interval per channel: 0.25ms
	Hardware filtering: 0.25ms, adjustable digital filtering up to 8ms
	Resolution: 11 bit + sign bit
	Inaccuracy: 2% of full scale range

### ACS880+N5350 CTDD Relay Outputs

The ACS880+N5350 CTDD has the ability of reporting drive status to the user by the use of relay outputs. For example, a relay can be set up to illuminate an external indicator light should the drive fault or a relay output could be wired to a controller as a status signal to indicate Trickle Rotation Active.

Three Form-C relay outputs are provided in the ACS880+N5350 CTDD. The functions of the relay outputs are selected by parameters 10.24 RO1 Source, 10.27 RO2 Source and 10.30 RO3 Source. For details on setting the Relay Output function see the *ACS880 Firmware manual*.

Figure 6-3 depicts connections to the relay outputs with their factory configured status. The relay outputs can be reconfigured to other user preferred outputs. See the *ACS880 Firmware manual* for reconfiguring relay outputs.

Figure 6-3 Relay Output Connections

**XR01, XR02, XR03 Relay outputs**

<b>1</b>	NC		<b>Ready</b>
<b>2</b>	COM		250 VAC / 30 VDC
<b>3</b>	NO		2 A
<b>1</b>	NC		<b>Running</b>
<b>2</b>	COM		250 VAC / 30 VDC
<b>3</b>	NO		2 A
<b>1</b>	NC		<b>Faulted (-1)</b>
<b>2</b>	COM		250 VAC / 30 VDC
<b>3</b>	NO		2 A

Electrical and mechanical specifications for the relay outputs are shown in Table 6-3

Table 6-3 Relay Output Technical Data

Relay outputs R01...R03 (XR01...XR03)	Connector pitch 5mm, wire size 2.5mm <sup>2</sup>
	250 VAC / 30VDC, 2 A
	Protected by varistors
+24 V output (XD24:2 and XD24:4)	Connector pitch 5mm, wire size 2.5mm <sup>2</sup>
	Total load capacity of these outputs is 4.8W (200mA / 24V) minus the power taken by DIO1 and DIO2.

### ACS880+N5350 CTDD Analog Outputs

Two analog outputs are provided in the ACS880+N5350 CTDD that can be used by the customer to indicate the value of various signals within the drive. For example, these analog outputs could be used to indicate motor speed and torque on remote meters or to a building control computer system. The functions of the analog outputs and their connection points are shown in Figure 6-4. Refer to parameters 13.12 through 13.20 to link the analog outputs to signals other than default.

Figure 6-4 Analog Outputs

XAO	Analog outputs	
1	A01	Motor speed rpm
2	AGND	0...20mA, $R_L > 500\text{ohm}$
3	A02	Motor torque
4	AGND	0...20mA, $R_L > 500\text{ohm}$

(Current is proportional to torque on the Baldor-Reliance Interior Permanent Magnet Cooling Tower Motor.)

Refer to Table 6-4 for electrical and mechanical specifications for the analog outputs.

Table 6-4 Analog Output Technical Data

Analog outputs A01 and A02 (XAO)	Connector pitch 5mm, wire size 2.5mm <sup>2</sup>
	0... 20mA, $R_{load} < 500\text{ohm}$
	Frequency range: 0...300Hz
	Resolution: 11 bit + sign bit
	Inaccuracy: 2% of full scale range



## 2-Wire Operating Mode (Default)

Figure 7-1 ACS880+N5350 CTDD 2-Wire Operating Mode Connection Diagram (Parameter 76.03 = 1)

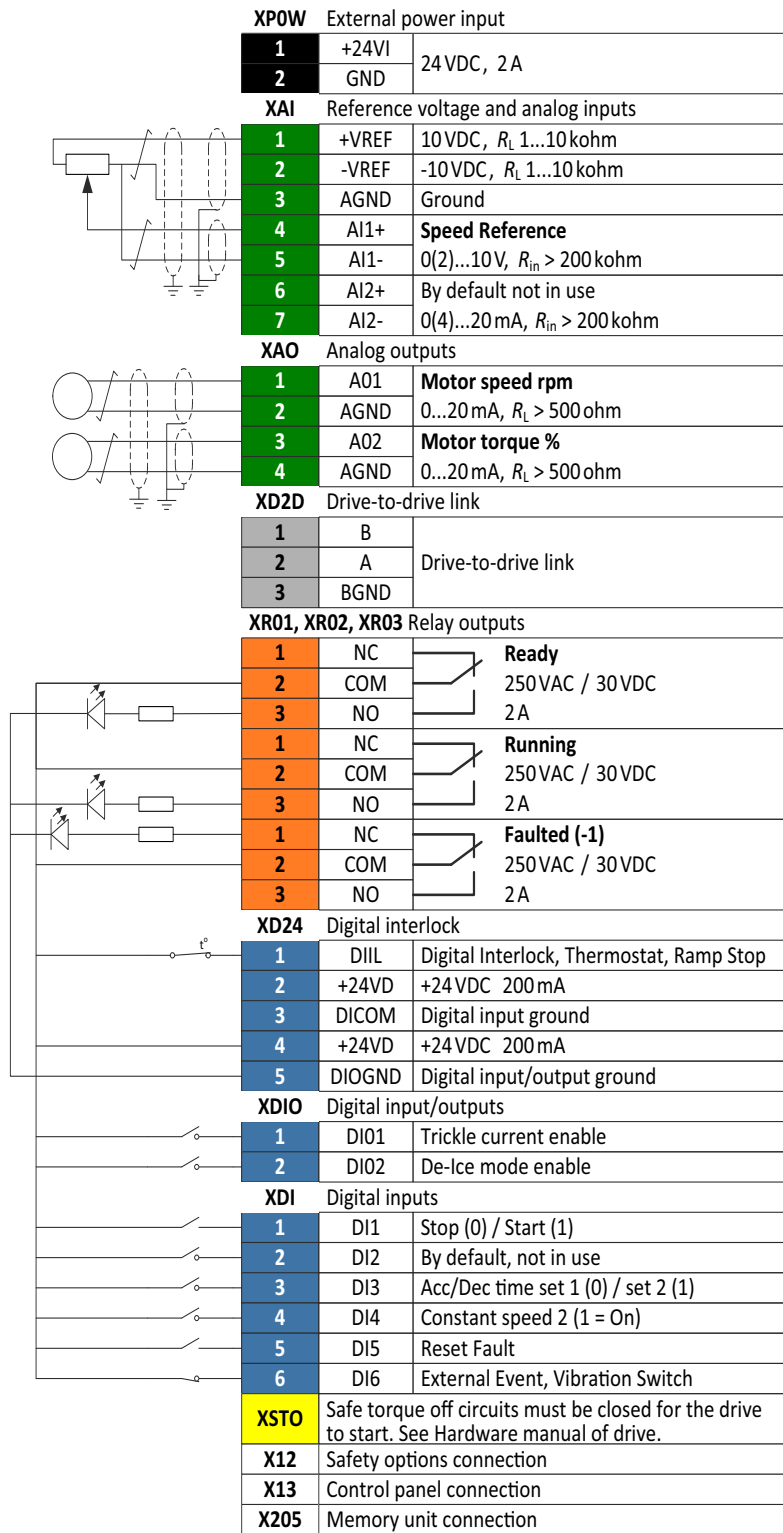

### 3-Wire Operating Mode

Figure 7-2 ACS880+N5350 CTDD 3-Wire Operating Mode Connection Diagram (Parameter 76.03 = 2)

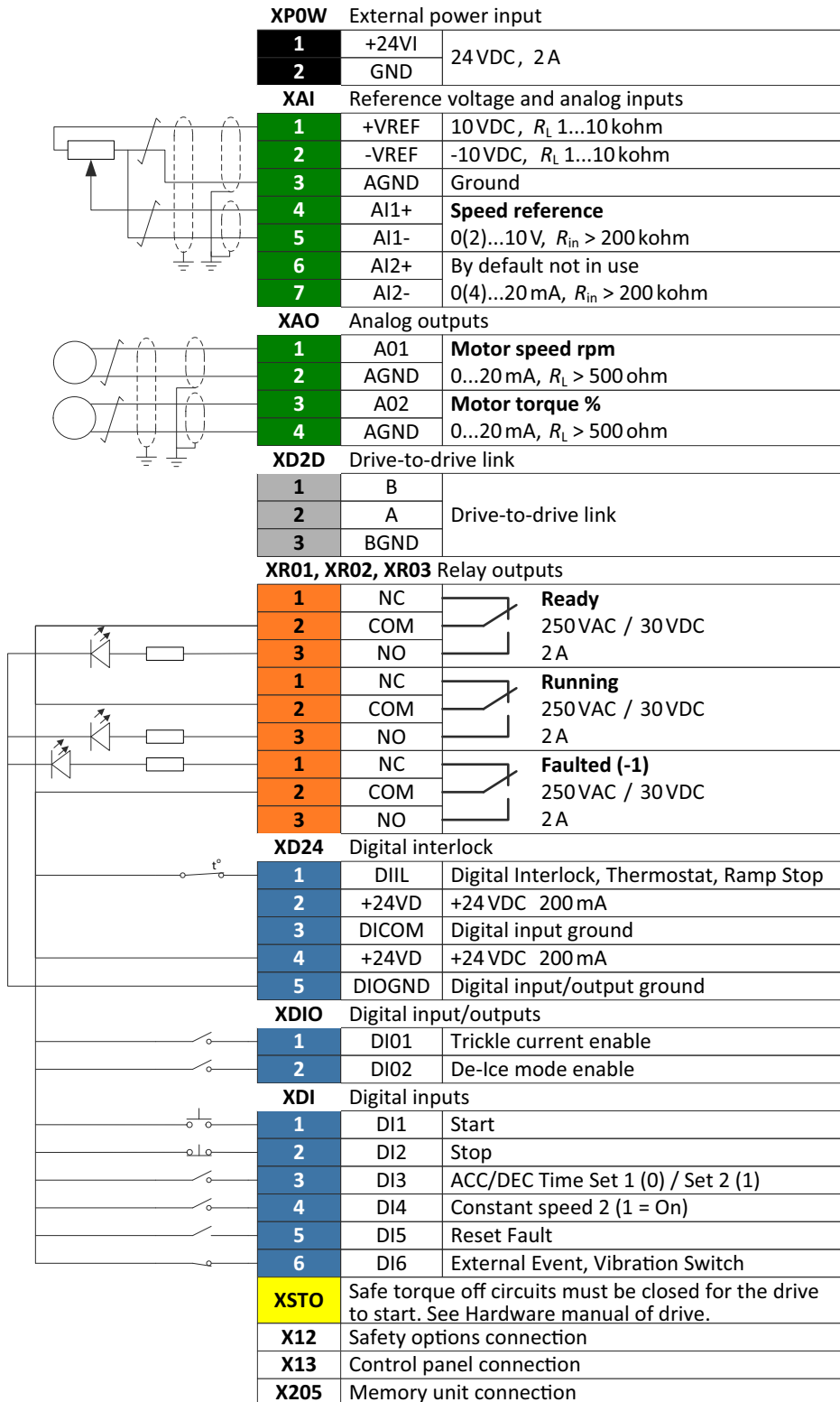

Note: In Three Wire Mode, if DI2 is open (Stop PB is pressed), both Trickle Current and De-Ice functions will operate.



## Process Control (PID) Operating Mode

The process control mode provides an auxiliary closed loop general purpose PID control.

For details on setting parameters and adjusting PID configuration see the ACS880 Firmware manual. Default I/O configurations are shown in the figure below.

Figure 7-3 ACS880+N5350 CTDD Process Control Operating Mode Connection Diagram (Parameter 76.03 = 3)

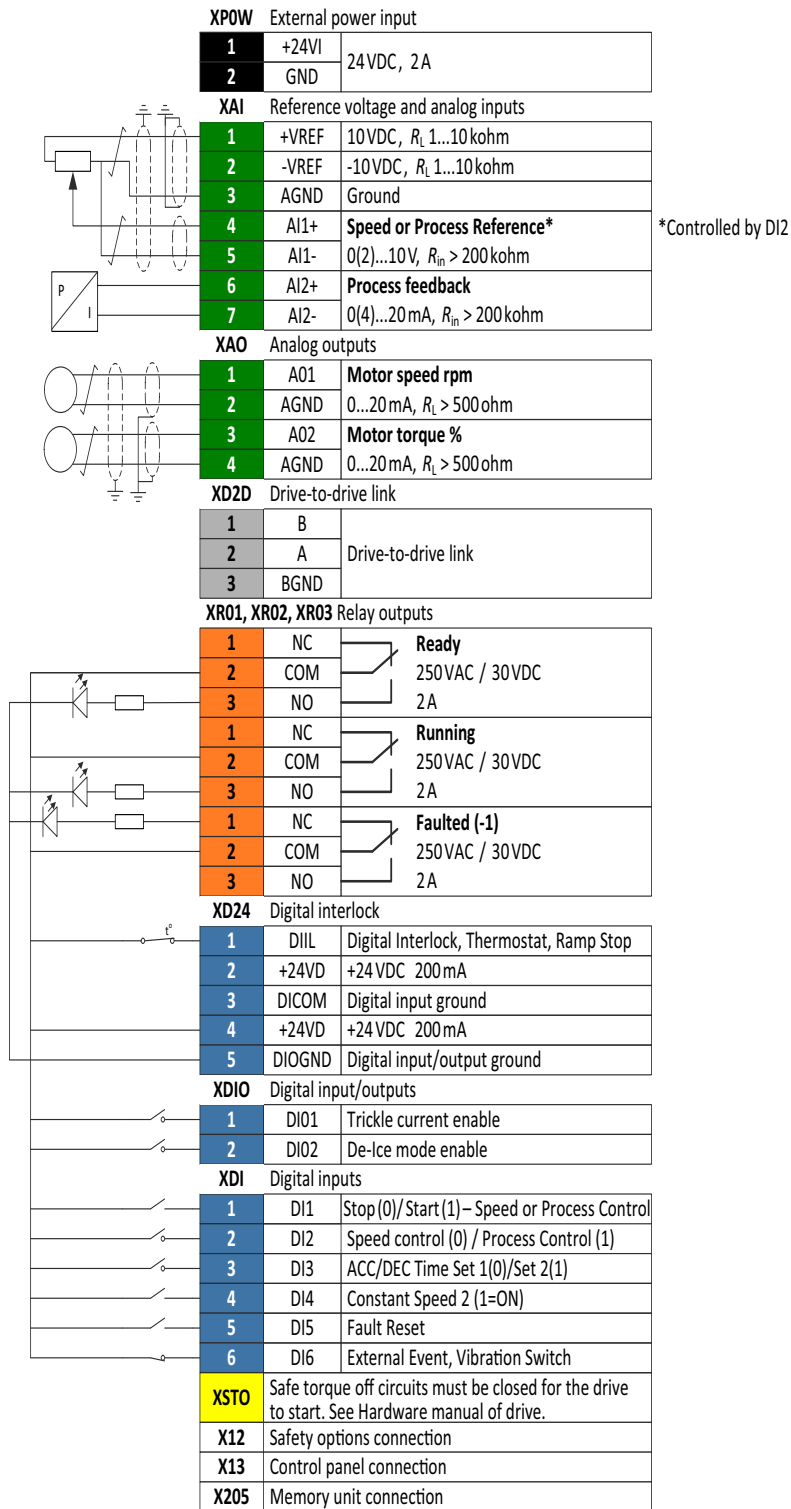

## Fieldbus Operating Mode

The drive can be connected to an external control system through an optional fieldbus adapter mounted onto the control board of the drive or via the Embedded Fieldbus (D2D Port – MODBUS – RTU Protocol). If DI2 is on, Fieldbus Operating Mode is selected, the drive Starts and Stops using the Main Command Word, (6.01) and speed reference is through fieldbus. The drive actually has two independent interfaces for fieldbus connection called “fieldbus adapter A” (FBA A) and “fieldbus adapter B” (FBA B). Fieldbus adapters are available for various communication systems and Industrial Protocols, including:

Field bus Adapter	Fieldbus Protocol	Fieldbus Module Plus Code
FDNA-01	DeviceNet™ Adapter	K451
FPBA-01	PROFIBUS DP Adapter	K454
FCAN-01	CanOpen Adapter	K457
FSCA-01	Modbus Adapter, comes with a price when Built-In Modbus	K458
FCNA-01	ControlNet™ Adapter	K462
FECA-01	EtherCAT Adapter	K469
FEPL-02	Ethernet Powerlink Adapter	K470
FENA-21	Two-Port Ethernet Adapter (EtherNet/IP™, Modbus/TCP, PROFINET IO)	K475
FEIP-21	Ethernet/IP	K490
FMBT-21	Modbus TCP/IP	K491
FPIO-21	Modbus TCP/IP	K492
<b>Notes:</b> <ul style="list-style-type: none"> <li>– Only Fieldbus Adapter A (FBA A or embedded Fieldbus (EFB) can be used to control the drive.</li> <li>– Only the transparent 16 profile can be used with the ACS880+N5350 CTDD due to the fact that additional control word bits and status word bits are used in the CTDD Application that are not supported in other profiles.</li> </ul>		

Note that if DI2 is off, drive control is through digital I/O where speed reference is from AI1 and start/stop is via DI1.

Figure 7-4 Fieldbus Operating Mode Connection Diagram (Parameter 76.03 = 4)

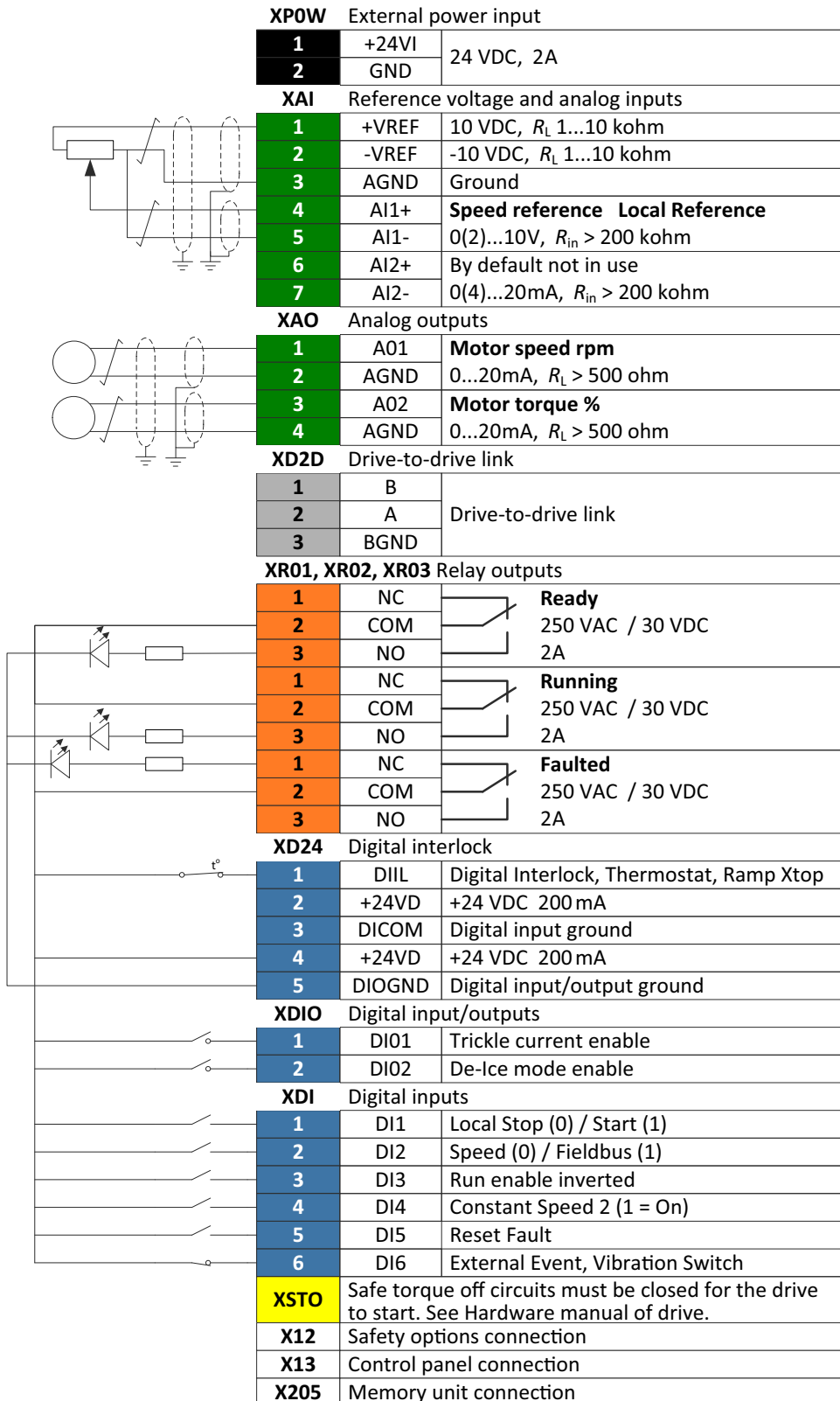

The remote reference is FBA Ref1.

## 36 Operating Modes

Note: DI2 must be connected to + 24 VDC for Remote Fieldbus Control to operate.

To activate Fieldbus Operating Mode, set parameter 76.03 (Operating Mode) to either “Fieldbus” (for FBA-A or FBA-B Control) or to “EFB” (for Embedded Fieldbus Control).

In addition to Starting and Stopping the drive, it is also possible to Activate Trickle Current Heating or De-Ice Mode through the Fieldbus Operating Mode.

### Fieldbus Control Word

The Main Control Word (MCW) in the ACS880+N5350 CTDD is different than that of a standard ACS880 drive. Three additional bits are available in the Control Word to control the drive:

Bit	Name	Value	Description
0	Trickle Current Heating	1	Trickle Current Heating Enabled
		0	Trickle Current Heating Disabled
1	De-Ice Mode	1	De-Ice Mode Enabled
		0	De-Ice Mode Disabled
2	Start Forward	1	Operation enabled with Forward run command
		0	Stopped
3	Reset	1	Fault reset if an active fault exists
		0	Continue normal operation
4-15	Reserved for Future Use		

To be able to activate Trickle Current Heating over the Communications link, parameter 74.01 (Trickle Current Selection) must be set to FBA (for Fieldbus Adapter Modules) or to EFB (for the Embedded Fieldbus on the D2D Port).

To be able to activate De-Ice Mode over the Communications link, parameter 75.01 (De-Ice Selection) must be set to FBA (for Fieldbus Adapter Modules) or to EFB (for the Embedded Fieldbus on the D2D Port).

For Modbus RTU setup see [Chapter 13](#).

For Ethernet IP setup see [Chapter 14](#).

For Modbus TCP setup see [Chapter 15](#).

---

## Fieldbus main status word

The Main Status Word (MSW) in the ACS880+N5350 CTDD is different than that of a Standard ACS880 drive. In addition to the standard bits 0-9, the ACS880+N5350 CTDD incorporates bits 10-14 for CTDD status.

Bit	Name	Value	Description
0	Ready to switch ON	1	Ready to switch ON
		0	Not ready to switch ON
1	Ready run	1	Ready to operate
		0	OFF1 active
2	Ready ref	1	Operation enabled
		0	Operation inhibited
3	Tripped	1	Fault
		0	No Fault
4	OFF2 inactive	1	OFF2 inactive
		0	OFF2 active
5	OFF3 inactive	1	OFF3 inactive
		0	OFF3 active
6	Switch-on inhibited	1	Switch-on inhibited
		0	--
7	Warning	1	Warning active
		0	No warning active
8	At setpoint	1	Operating - Actual value equals reference = is within tolerance limits (see parameters 46.21 - 46.23)
		0	Actual value differs from reference = is outside tolerance limits
9	Remote	1	Drive control location: Remote (EXT1 or EXT2)
		0	Drive control location: Local
10	Trickle Current Active	1	Trickle Current ON
		0	Trickle Current OFF
11	De-Ice Mode Active	1	De-Ice Mode ON
		0	De-Ice Mode OFF
12	CTDD Run	1	CTDD Running
		0	CTDD Not Running
13	CTDD HOLD	1	CTDD Autophase ON
		0	CTDD Autophase OFF
14	Trickle Rotate Active	1	Trickle Current Rotation Enabled
		0	Trickle current Rotation Disabled
15	Reserved		



## Additional Setup

---

At this point the drive still has not had power applied. This chapter will provide additional information needed to setup the Trickle Current Heating, Critical frequency avoidance bands, Trickle Rotation, User Passwords, and De-Ice functionality of the CTDD.

Once the motor has been identified to the drive and the operating mode chosen, the drive is ready to operate. Additional setup may be desired to enable trickle current heating when the motor is not running, skip frequencies avoidance to minimize mechanical resonances during operation, and enabling the De-Ice control function.



**WARNING:** Obey these instructions. If you ignore them, injury or death, or damage to the equipment may occur. Unexpected motor rotation can occur when using this feature.

---



**WARNING: Unexpected rotation can occur with the drive commanded to stop!** The fan motor will rotate periodically if Trickle Current is enabled, even if the drive has a stop command. A rotational trickle current function is implemented by default to prevent motor bearing damage.

---

### Trickle Current Heating

It is HIGHLY recommended that you utilize the startup assistants to configure the CTDD. Configuring parameters in the specific parameter groups alone should be left to qualified ABB personnel.

For +N5350 firmware revision 2.00.3.3 or earlier, Trickle Current Heating is a feature of the ACS880+N5350 CTDD that can be used by the customer to maintain a small amount of power to the motor while the cooling tower fan is not operating. This feature aids in eliminating moisture in the motor.

For +N5350 firmware revision later than 2.00.3.3, Trickle Current Heating is a feature of the ACS880+N5350 CTDD that can be used to maintain a small amount of power to the motor while the CTDD is not being used. This feature will cause fan rotation and aids in eliminating moisture in the motor and redistributing bearing grease. Default rotation is setup to occur once every hour for a period of 4 minutes at 10% rated motor speed. See parameter group [74 Trickle Current](#) - for Rotational Trickle Current setup.

Trickle Current Heating is disabled when the drive ships from the factory because its setup depends on motor related information. Once enabled, trickle current will start flowing in the motor windings after the cooling tower drive has been stopped. Note that the drive trickle current enable signal on XDIO1 must be present for trickle current to flow and (parameter [74.01](#)) Trickle Current Enable = 1. Should the motor be restarted at any time, trickle current will immediately stop and the motor will start normally. The Cooling tower Run Command has priority over Trickle Current.

ABB recommends that if the Trickle Current function is incorporated in the cooling tower application, the CTDD firmware should be updated to a version later than 2.00.3.3 to extend the life of the Baldor – Reliance Permanent Magnet Cooling Tower motor.

---

Figure 8-1 below contains a timing diagram of how the command and status words toggle when utilizing Trickle Current. Note Auto-Phase only occurs once during the start of the trickle current cycling. Whenever the CTDD is started, Trickle Current immediately stops and the CTDD starts the fan motor.

Figure 8-1 Trickle Current Timing Chart

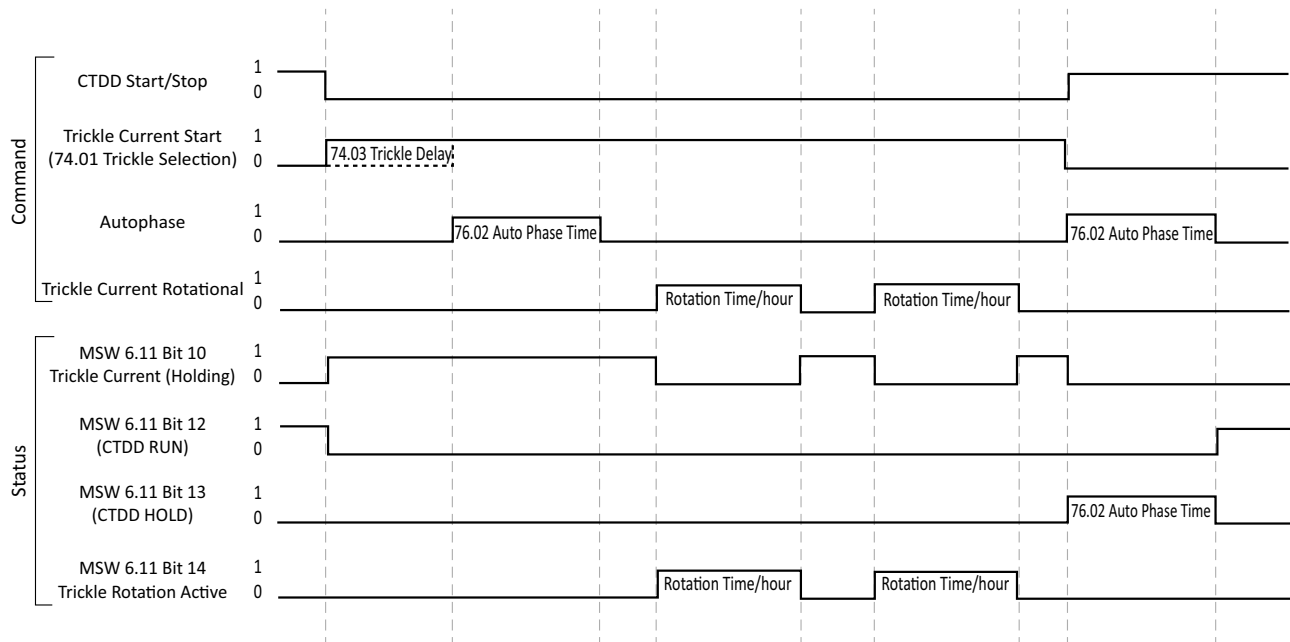

## Trickle Current Power

Use Table 8-1 to determine the correct Trickle Power wattage. This wattage is based on the motor frame size. Find the cooling tower motor frame size from the motor nameplate to determine the Trickle Power Watts in the table below. Enter this value in parameter 74.02.

Table 8-1

Motor Frame Size	Trickle Power Wattage
FL210	75
FL250	75
FL280	100
FL320	125
FL360	150
FL400	175
FL440	225
FL580	400

A value in the Trickle Power parameter will enable trickle current to flow in the motor after it has been stopped for the time set in parameter 74.03 Trickle Delay Time. Note that the customer is limited to a current value that is no more than 100% of the motor rated current so that there is no danger in overheating the motor.

Should the cooling tower fan motor be restarted at any time (before or after Trickle Delay timer has expired) trickle current will immediately stop and the motor will start normally.

The “Running” relay is energized whenever the drive runs the motor, including during trickle current. If there is a desire to remove the trickle current running status from the running relay, in Expert Mode redirect Relay 2 to MSW 6.11 Bit 12 CTDD Run. This will remove the trickle current running status from the Running relay.

**Note:** Trickle current will not work while the drive is in Local control.

## Critical Speed Function

When applying a variable speed control to a cooling tower fan, mechanical resonances may occur at various points of operation. The ACS880+N5350 CTDD provides for up to three frequency avoidance bands that are used to prohibit continuous operation at the points of mechanical resonance.

While in LOCAL control, the keypad can be used to start and stop the drive and to locally adjust the speed.

Use the “UP” arrow key to slowly increase the speed of the motor. Should the cooling tower fan start to resonate, record the RPM. Continue this process until you have tested the motor at all points between minimum speed and maximum speed.

The parameters that are used to setup the three frequency avoidance bands are 22.52 through 22.57. Program a band around each machine resonance point using parameter settings critical speed low and high.

## De-Ice Function

De-Ice is a CTDD function to run the motor at low speed in the opposite (reverse) direction than standard in an effort to prevent ice build-up in colder climates.

When De-Ice is enabled with XDIO2 terminal input made, the drive will enter De-Ice mode for the De-Ice Run Time set in parameter 75.03. If parameter 75.03 is set to zero (0), the De-Ice function will run continuously. If the drive has a valid Run Command applied at the same time as a De-Ice Command, the drive will run in De-Ice Mode (reverse) for the specified time and then enter a normal cooling tower Run mode.

### NOTE: De-Ice in Keypad Operation

The Keypad operates the CTDD in local control. To initiate De-Ice while using the Keypad, the drive must first be placed in remote control.

## De-Ice Parameter Settings

De-Ice parameters can be found in the parameter section 75 De-Ice Function.

It is HIGHLY recommended that you utilize the startup assistants to configure the CTDD. Configuring parameters in the specific parameter groups alone should be left to qualified ABB personnel.

## CTDD Assistant Access

In addition to programming changes in parameter group 75 De-Ice Function, De-Ice function setup is also an option under the CTDD startup assistant:

Figure 8-2 De-Ice Function

Remote	( <sup>-</sup> CTDD	579.4 rpr
<b>De-Ice</b>		
Set parameters for De-ice.		
De-Ice enable	DI02	
De-Ice Speed	30%	
De-Ice Run Time	1 min	
Minimum torque 1	-50.0%	
<b>Back</b>	08:49 am	<b>Next</b>

## Advanced Drive Settings

See ACS880 Firmware manual, for information on advanced drive functions including PID and Fieldbus control.



## **Access Levels**

There are three access levels for the CTDD parameters including CTDD USER, Fieldbus or Expert Commissioner. Selection for access level is in parameter 96.02. Passcode changes are for expert users only and are only accessible in the programming window (but not through the startup assistant). Changing modes will automatically set access level.

Fieldbus operating mode opens up all parameters in groups 50.01 to 56.01 and monitoring parameters 3.05, 3.06, 6.01 and 6.11 (Reference [ACS880 Firmware manual](#)).

The default passcode setting for parameter 96.02 is 0. Setting access level to 13 (Fieldbus) opens all Fieldbus applicable parameters. Expert Commissioner enables all parameters in the drive by setting 96.02 = 12.

Parameter 96.03 shows the current access level setting. Note that bit 0 is always on. The value is offset by one from the password entered.

**NOTE:** The drive will reset to CTDD User access level on a power cycle.

---

### Access Level Flow Diagram

Figure 8-3 Access Level Flow Diagram below will provide guidance on setting pass codes and access levels.

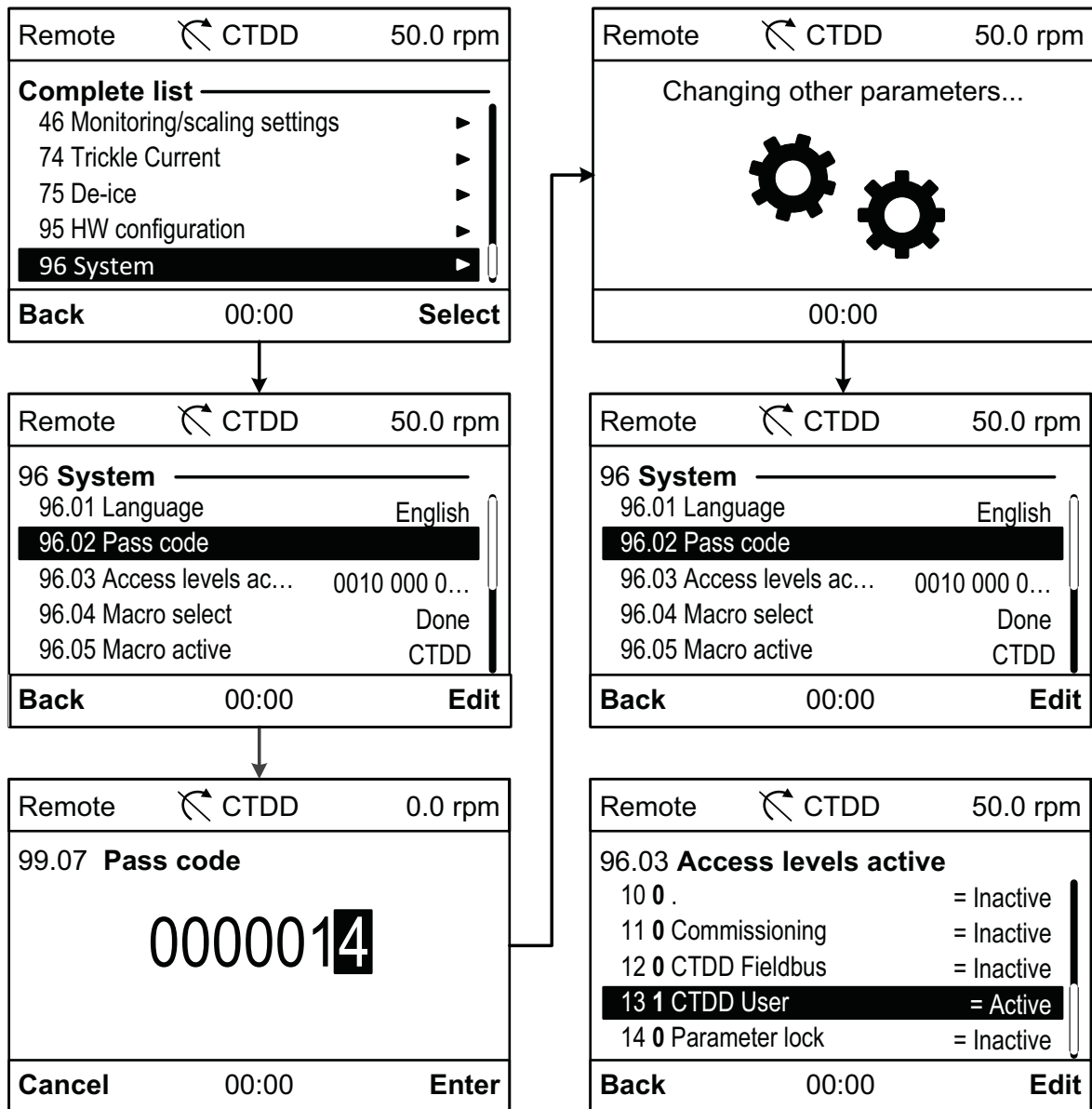



# Applying Power

---



**WARNING:** Ignoring the following instructions can cause physical injury or death, or damage to the equipment.

---

Follow the safety information listed in [Chapter 1](#).

For installation, wiring, and startup please refer to the appropriate [Quick installation and start-up guide](#) and the [Hardware manual](#).

Once the drive is powered, the startup assistants on the drive control panel will direct the operator to setup the drive and motor combination, perform a motor ID run, and setup the CTDD functions. Refer to this procedure in [Chapter 10](#).

---



**WARNING: Unexpected rotation can occur with the drive commanded to stop!** The fan motor will rotate periodically even if the drive has stop command. If Trickle Current is enabled, a rotational trickle current function is implemented by default to prevent motor bearing damage.

---

## 10

# Startup Assistant

---

## Startup Assistants for the ACS880+N5350 CTDD

This chapter describes the basic startup assistants for motor data and motor ID run, and for setting up the ACS880+N5350 CTDD. Complete documentation of the drive firmware can be found in [ACS880 Firmware Manual](#).

Note: Two startup assistants must be completed to correctly setup the CTDD. First, complete the Motor Data & ID Run assistant as shown in [Table 10-1](#). After saving the motor setup, run the CTDD Setup assistant as shown in [Table 10-2](#).



**Failure to complete both assistants will result in default parameter settings for the cooling tower software and could cause drive faults or unstable operation.**

In the event that the start assistants were not completed correctly or if for any reason a complete start-over is required, set parameter 96.04 to CTDD. Then rerun both startup assistants.

Never work on the drive, braking chopper circuit, motor cable or motor when power is applied to the drive. Always ensure safety by measuring that no voltage is present.

NOTE: Before you start ensure that the drive has been mechanically and electrically installed as described in the [Quick installation and start-up guide](#), the [Hardware manuals](#) and in this manual.













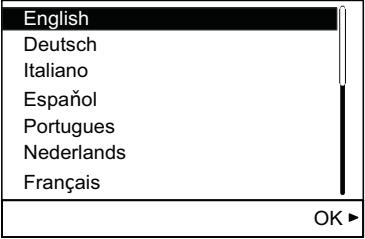

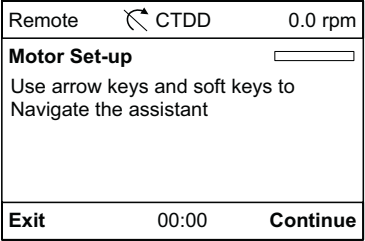

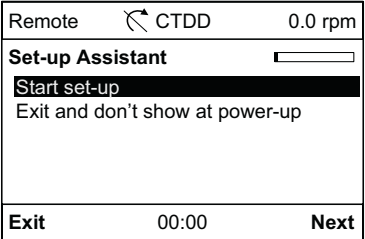

**WARNING:** All electrical installation and maintenance work on the drive should be carried out by qualified electricians.

## Motor Data and ID Run

On initial startup, the drive automatically goes into the Motor Data & ID Run startup assistant screen. Work through the next setup sections using the assistants to correctly setup the CTDD parameters.

Table 10-1 Initial Startup / Motor Data and ID Run

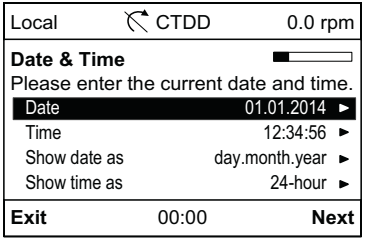
Initial Startup / Motor Data and ID Run	
<b>Safety</b>	
	The Startup may only be carried out by a qualified electrician. The safety instructions must be followed during the Startup procedure. See the safety instructions on the first pages of the appropriate <a href="#">Hardware manuals</a> and in <a href="#">Chapter 1</a> of this manual.
<input type="checkbox"/>	Check the installation. See the installation checklist in the appropriate <a href="#">Hardware manuals</a> .
<input type="checkbox"/>	Check that the starting of the motor does not cause any danger. De-couple the driven machine if there is a risk of damage in case of an incorrect direction of rotation.
<b>Power-Up, Date and Time Settings</b>	

Initial Startup / Motor Data and ID Run	
<p><input type="checkbox"/> Power up the drive.</p> <p>On initial power up the CTDD requests a language selection for the setup process.</p> <p>NOTE: CTDD related parameters are shown in English only.</p> <p>Select language using  and  and press  (continue) to accept.</p> <p>The drive will load the selected language; this may take a few minutes.</p>	
<p><input type="checkbox"/> Motor Data and ID Run Assistant will load.</p> <p>Press  (continue) to begin the cooling tower startup assistant.</p>	
<p><input type="checkbox"/> Press  (Next) to start the set-up assistant.</p>	
<p><input type="checkbox"/> In the Date &amp; Time menu, use the   to highlight the value to edit. It is recommended to set the current date &amp; time so that faults &amp; alarms can provide accurate time stamps. Highlight date and press  to edit or  (Next) to continued.</p> <p>In the month screen use   to select the value for editing. Use   to modify the value. Pressing  (Save) returns to the date &amp; time menu.</p> <p>This screen is only visible the first time the Motor Data and ID Run assistant is run.</p>	 
Unit Selection	

Initial Startup / Motor Data and ID Run	
<p><input type="checkbox"/> Confirm local units. Highlight selection with the   and press  (Next).</p>	
<p><input type="checkbox"/> Highlight the desired unit with the   and press  (Next).</p> <p>Use   to move between the units. Use  to select the value for editing.</p> <p>Pressing  (Save) returns to the unit selection menu.</p>	
Supply Voltage Settings	
<p><input type="checkbox"/> Press  to edit the supply voltage input to the CTDD drive.</p> <p>NOTE: For 460...480 V, it is recommended that supply voltage is set to 500 V.</p>	
Motor Data Settings	
Refer to the motor nameplate for the following parameter settings. Whenever possible, enter the values exactly as shown on the motor nameplate.	
<p>Example of a nameplate of a Back-EMF motor:</p>	<p>Example of a nameplate of a permanent magnet motor:</p>

Initial Startup / Motor Data and ID Run

Highlight the motor value to be edited using **▲** **▼** keys. Use **▶** to edit the values.

Use **▲** and **▼** to change the value of a digit. Use **◀** and **▶** to move the cursor left and right. Press **↵** (Save) to enter the value.

Important! Motor Back EMF voltage (located on the motor nameplate) is critical to the successful operation of the cooling tower motor. Please record this data here for future reference.

Back EMF Voltage: \_\_\_\_\_

Motor Serial Number: \_\_\_\_\_

Drive Serial Number: \_\_\_\_\_

NOTE: Back EMF Voltage is referred to as Measured Open Circuit Voltage on the motor nameplate.

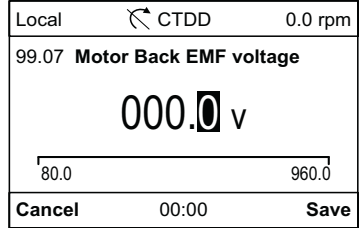
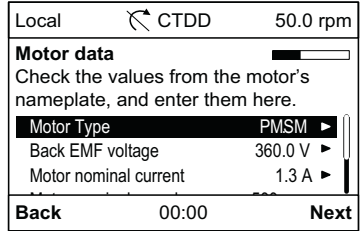
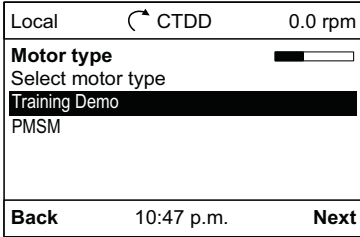





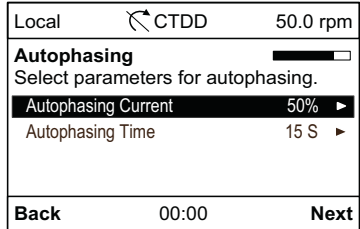

Motor ID Run

**Autophasing**



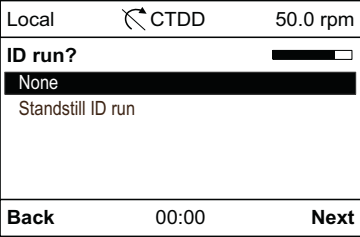
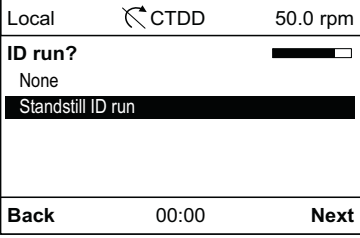

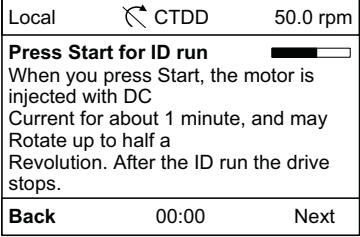
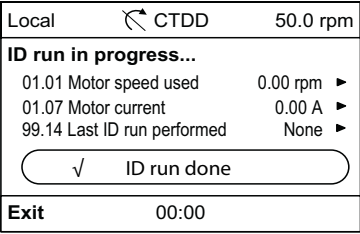

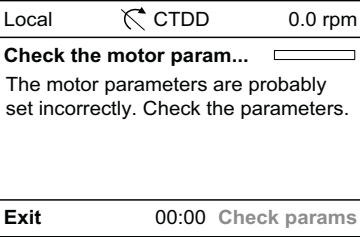







The drive is now ready to run the motor identification routine (ID run). During the ID run, the motor is injected with DC current. Autophase stops the rotor prior to the ID run.

NOTE: Autophase time has a default of 15 seconds. It is best to observe the time it takes the fan to stop moving and use this as an accurate autophase time. Use the **▲** **▼** keys to move between selections. Use **▶** to select the value to edit.



Initial Startup / Motor Data and ID Run	
<p><input type="checkbox"/> <b>Motor ID Run</b></p> <p>The drive is now ready to run the motor identification routine (ID run). The motor is injected with DC current.</p> <p>Use the  key to select Standstill ID run and then press  (Next).</p> <p><b>NOTE:</b> On initial startup, an ID run must be performed and Next will not advance to next step.</p>	 
<p><input type="checkbox"/> <b>Motor ID Run</b></p> <p>No command rotation is given, however with a permanent magnet motor the shaft could rotate up to half a revolution.</p> <p>You must press Local Keypad START to activate ID Run.</p> <p><b>NOTE:</b> ID Run requires Local control, press  if the Keypad does not indicated local control is active.</p> <p>Next is not visible until ID run is performed once.</p>	
<p><input type="checkbox"/> The ID run in progress screen will automatically display showing speed and amps.</p> <p>The screen will also indicate if an ID run has been completed before. If not, it will read "none". If a run has been completed, it will read "Standstill".</p> <p>When ID run is complete, the next screen will be displayed.</p>	
<p><input type="checkbox"/> <b>NOTE:</b> If the motor data is incorrect, after pressing , the display will indicate check motor parameters. Press  (exit) and check that the motor information is correct.</p>	













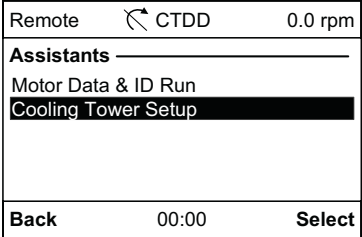

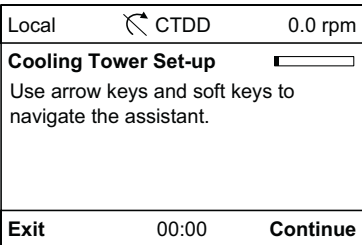

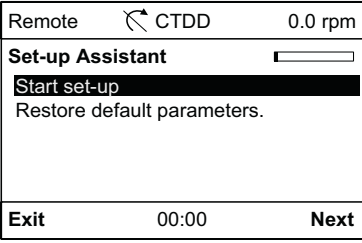
Initial Startup / Motor Data and ID Run		
<input type="checkbox"/>	<p><b>Direction Test</b></p> <p>NOTE: The Autophasing delay occurs every time the motor starts, including direction testing.</p> <p>Use the  key to perform a direction test of the rotation of the motor. Then press  (Next).</p>	<div data-bbox="938 254 1300 485"> <p>Local  CTDD 50.0 rpm</p> <p><b>Direction test</b> </p> <p>Spin the motor to check direction</p> <p><b>No, skip the test</b></p> <p>Yes, test now</p> <p><b>Back</b> 00:00 <b>Next</b></p> </div> <div data-bbox="938 527 1300 758"> <p>Local  CTDD 50.0 rpm</p> <p><b>Direction test</b> </p> <p>Spin the motor to check direction</p> <p>No, skip the test</p> <p><b>Yes, test now</b></p> <p><b>Back</b> 00:00 <b>Next</b></p> </div>
<input type="checkbox"/>	<p>The following warning message will appear.</p> <p>Press START to check direction of the motor.</p>	<div data-bbox="938 825 1300 1056"> <p>Local  CTDD 50.0 rpm</p> <p><b>Press Start</b> </p> <p>Warning! Until set-up is done, safeties are not activate and motor speed is limited between 1/3 to 2/3 speed. Press Start now to start the motor, then check the direction of rotation.</p> <p><b>Back</b> 00:00 <b>Next</b></p> </div> <div data-bbox="938 1098 1300 1329"> <p>Local  CTDD 50.0 rpm</p> <p><b>Is this forward</b> </p> <p>Selecting ' No fix direction' tells the drive to change directions, and labels the new direction 'forward'.</p> <p><b>Yes, motor is rotating 'forward'</b></p> <p>No, fix direction</p> <p><b>Back</b> 00:00 <b>Next</b></p> </div>
<input type="checkbox"/>	<p>Motor set-up is complete.</p> <p>To exit and save all data, select  (Done).</p> <p>To exit without saving data, select  (cancel).</p>	<div data-bbox="938 1430 1300 1661"> <p>Local  CTDD 50.0 rpm</p> <p><b>Motor set-up complete</b> </p> <p>Connect I/O according to the User Manual.</p> <p><b>Cancel</b> 00:00 <b>Done</b></p> </div>











NOTE: If the motor ID is saved, you will be directed to begin CTDD setup. If drive is power cycled at this point, you will need to manually go to CTDD setup assistant to complete the setup.

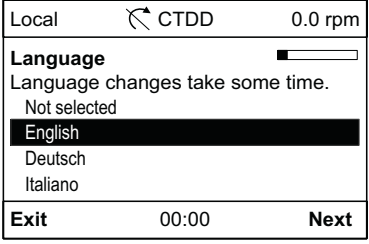



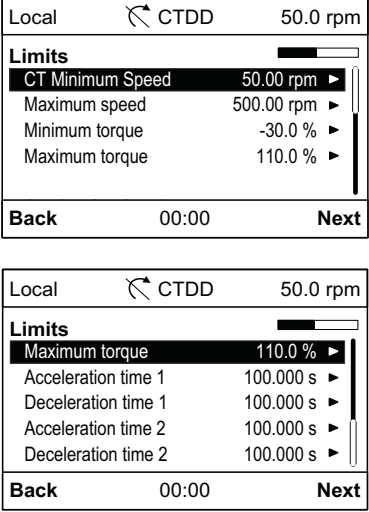

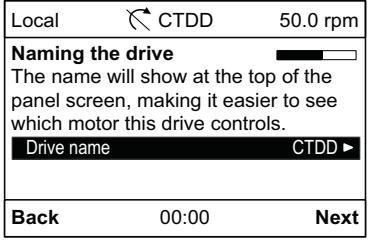

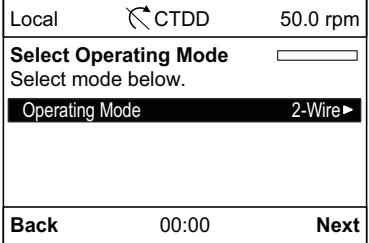

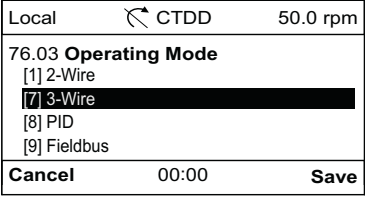







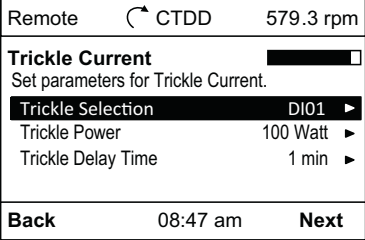





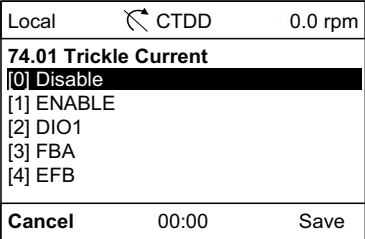

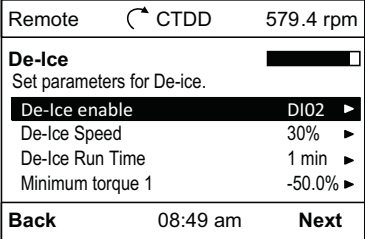

## Drive Assistant Cooling Tower Setup

Selecting drive assistant CTDD will display the cooling tower application assistant.

Table 10-2 Drive Assistant

<input type="checkbox"/>	<p>Selecting the Cooling Tower Setup will display the cooling tower application assistant.</p>	
<input type="checkbox"/>	<p>In the assistant view, press  (continue) to enter the Startup Assistant.</p> <p>NOTE: To leave the assistant, press  (exit) and go back to the Home screen.</p>	
<input type="checkbox"/>	<p>Press  (Next) to start the set-up assistant.</p> <p>“Restore...” will reload all default parameters except for motor data.</p>	
<input type="checkbox"/>	<p>In the Date &amp; Time menu, use the   to highlight the value to edit. It is recommended to set the current date &amp; time so that faults &amp; alarms can provide accurate time stamps. Highlight date and press  to edit or  (Next) to continued.</p> <p>In the month screen use   to select the value for editing.</p> <p>Use   to modify the value. Pressing  (Save) returns to the date &amp; time menu.</p>	
<p>NOTE: After editing all desired date &amp; time values, press (Next) to continue.</p>		
<p>Drive Limit Settings</p>		

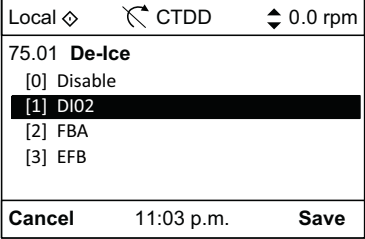



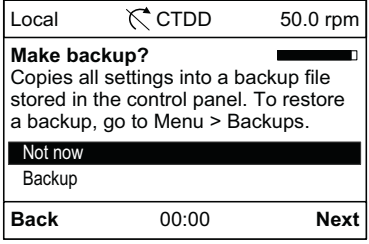
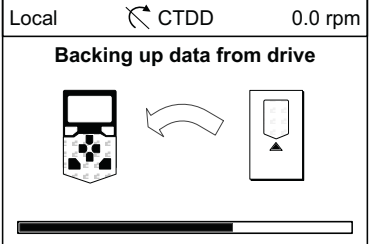
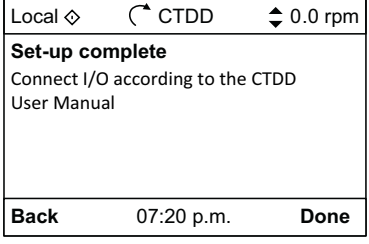

<input type="checkbox"/>	<p>Highlight the language with the   and press  (continued).</p> <p>Note: CTDD related parameters are shown in English only.</p>	
<input type="checkbox"/>	<p>The CTDD will automatically set limits according to motor data entered. For most CTDD applications, the default values are acceptable. However, values are adjustable within Limits:</p> <p>Minimum Speed <math>\geq</math> 10% Motor Speed  Maximum Speed <math>\leq</math> Motor Speed  Minimum Torque set to -30% (adjustable)  Maximum Torque set to 110% (adjustable)</p> <p>Use the   to highlight the ramp rate to be adjusted. Press  to enter the edit screen once highlighted or  (Next) if the default value is acceptable.</p>	
<input type="checkbox"/>	<p>Naming the Drive</p> <p>If it is desirable to change the name of the CTDD, use  to edit the drive name or  (Next) to continue.</p>	
<b>Selecting Operating Mode</b>		
<input type="checkbox"/>	<p>Select Operating Mode</p> <p>Operating modes are sets of default wire and parameters suitable for most CTDD applications.</p> <p>The active operating mode is displayed, (2-wire) default. If this is correct, press  (Next). To edit the operating mode press .</p> <p>Caution: Ensure drive is stopped and in Local before changing mode. Drive could unexpectedly start when changing mode.</p>	

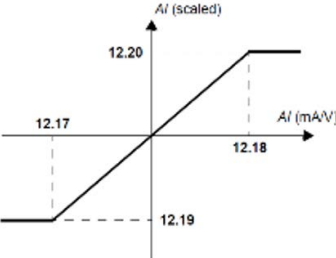
<input type="checkbox"/>	<p>Highlight the operating mode suitable to the application and press save.</p> <p>Press  (Save) to select.</p> <p>If mode was changed, cycle power to drive after setup is complete.</p>	 <p>Local  CTDD 50.0 rpm</p> <p>76.03 <b>Operating Mode</b></p> <p>[1] 2-Wire</p> <p><b>[7] 3-Wire</b></p> <p>[8] PID</p> <p>[9] Fieldbus</p> <p><b>Cancel</b> 00:00 <b>Save</b></p>
<b>Additional Settings &amp; Parameter Backup</b>		
<input type="checkbox"/>	<p><b>Trickle Current Function</b></p> <p>Primary purpose is to prevent fan rotation during standby condition and to prevent condensation in the motor. Use the  to enable the function in software. Highlight enable or fieldbus and press  (Save). Use   to highlight trickle power and  to set the level. Refer to Chapter 10 or parameter group 74 for proper setup of this function. When finished, press  (Next) to continue.</p>	 <p>Remote  CTDD 579.3 rpm</p> <p><b>Trickle Current</b> </p> <p>Set parameters for Trickle Current.</p> <p><b>Trickle Selection</b> DI01 </p> <p>Trickle Power 100 Watt </p> <p>Trickle Delay Time 1 min </p> <p><b>Back</b> 08:47 am <b>Next</b></p>
<input type="checkbox"/>	<p><b>Trickle Selection</b></p> <p>Select the I/O or Communication Link that will Enable the Trickle Current Function.</p> <p>If you select "ENABLE", the Trickle Current Function will be Enabled whenever the Drive is not running.</p>	 <p>Local  CTDD 0.0 rpm</p> <p><b>74.01 Trickle Current</b></p> <p><b>[0] Disable</b></p> <p>[1] ENABLE</p> <p>[2] DIO1</p> <p>[3] FBA</p> <p>[4] EFB</p> <p><b>Cancel</b> 00:00 <b>Save</b></p>
<input type="checkbox"/>	<p><b>De-Ice</b></p> <p>This is a Cooling Tower mode to run the tower in reverse at a slow speed to prevent ice build up. Use the   to highlight the setting and  to access level values.</p> <p>Refer to Chapter 10 or parameter group 75 for proper setup. When finished, press  (Next) to continue.</p>	 <p>Remote  CTDD 579.4 rpm</p> <p><b>De-Ice</b> </p> <p>Set parameters for De-ice.</p> <p><b>De-Ice enable</b> DI02 </p> <p>De-Ice Speed 30% </p> <p>De-Ice Run Time 1 min </p> <p>Minimum torque 1 -50.0% </p> <p><b>Back</b> 08:49 am <b>Next</b></p>
<input type="checkbox"/>	<p><b>De-Ice Selection</b></p> <p>Select the I/O or Communication Link that will Enable De-Ice mode</p>	 <p>Local  CTDD  0.0 rpm</p> <p>75.01 <b>De-Ice</b></p> <p>[0] Disable</p> <p><b>[1] DI02</b></p> <p>[2] FBA</p> <p>[3] EFB</p> <p><b>Cancel</b> 11:03 p.m. <b>Save</b></p>

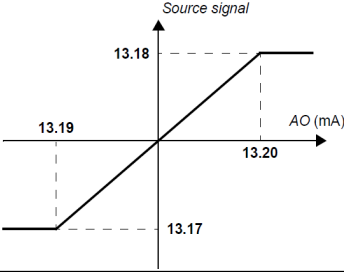
<p><input type="checkbox"/> <b>Backup</b></p> <p>Copies all settings into a backup file stored in the control panel. Press   to highlight Backup and  to begin the Backup.</p>	 <p>Local  CTDD 50.0 rpm</p> <p><b>Make backup?</b> <input type="checkbox"/></p> <p>Copies all settings into a backup file stored in the control panel. To restore a backup, go to Menu &gt; Backups.</p> <p><b>Not now</b></p> <p>Backup</p> <p><b>Back</b> 00:00 <b>Next</b></p>
<p><input type="checkbox"/> <b>Backup Status</b></p> <p>A status screen indicates progress.</p>	 <p>Local  CTDD 0.0 rpm</p> <p><b>Backing up data from drive</b></p> <p> </p> <p></p>
<p><input type="checkbox"/> Press  (Done) to back out and exit to home menu.</p>	 <p>Local   CTDD  0.0 rpm</p> <p><b>Set-up complete</b></p> <p>Connect I/O according to the CTDD User Manual</p> <p><b>Back</b> 07:20 p.m. <b>Done</b></p>

Check/adjust the following parameters.

<p><input type="checkbox"/></p>	<p>12.17 AI1 min          12.18 AI1 max          12.19 AI1 scaled at AI1 min          12.20 AI1 scaled at AI1 max</p> <p>The default input for speed reference is analog input AI1. (This is controlled by the parameters in Group 22 Speed reference selection.)</p> <p>Parameters 12.17 and 12.18 set the low and high limits of the analog input signal. Scaling parameters 12.19 and 12.20 define the internal signal levels that correspond to these limits as follows:</p> <div style="text-align: center;">  </div> <p>The corresponding parameters for analog input AI2 are 12.27 - 12.30.</p>
---------------------------------	---

<input type="checkbox"/>	<p>13.12 AO1 source          13.17 AO1 source min          13.18 AO1 source max          13.19 AO1 out at AI1 src min          13.20 AO1 out at AI1 src max</p> <p>Parameter 13.12 selects the source for analog output AO1 (by default, motor speed in rpm).          Parameters 13.17 and 13.18 set low and high source signal values that correspond to the actual analog output values defined by parameters 13.19 and 13.20.</p> 
<input type="checkbox"/>	<p>Start the drive with a positive (forward) speed reference:</p> <p>From control panel (Local control): In the Home view, press  (Options), select Reference, adjust the reference using the , , ,  and keys, press Save, and press the <b>Start</b> button.</p> <p>From I/O: In Remote control, adjust analog input AI1 (reference), switch digital input DI1 to 1 (start).</p>



**WARNING: Unexpected rotation can occur with the drive commanded to stop!** The fan motor will rotate periodically even if the drive has stop command. If Trickle Current is enabled, a rotational trickle current function is implemented by default to prevent motor bearing damage.

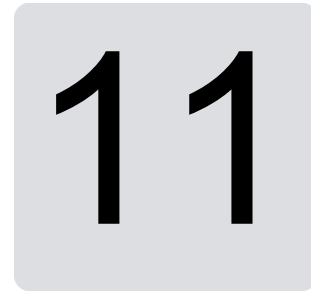

# Parameters

---

## ACS880 CTDD Parameters

The parameters listed below are included because their default values are typically different than those in the standard ACS880 drives. For additional parameters refer the [ACS880 Firmware manual](#).

Table 11-1 Terms and Abbreviations

Term	Definition
Actual Signal	Type of parameter that is the result of a measurement or calculation by the drive, or contains status information. Most actual signals are read-only, but some (especially counter-type actual signals) can be reset.
Def	(In the following table, shown on the same row as the parameter name) The default value of a parameter when used in the CTDD macro.
FbEq16	(In the following table, shown on the same row as the parameter range, or for each selection) A dash (-) indicates that the parameter is not accessible in 16-bit format.
Other	The value is taken from another parameter. Choosing "Other" displays a parameter list in which the user can specify the source parameter.
Other [bit]	The value is taken from a specific bit in another parameter. Choosing "Other" displays a parameter list in which the user can specify the source parameter and bit.
Parameter	Either a user-adjustable operating instruction for the drive, or an actual signal.
p.u.	Per unit

---

## Summary of parameter groups

Group	Contents	Page
06 Control and status words	Drive control and status words.	57
11 Standard DIO, FI, FO	Configuration of digital input/outputs and frequency inputs/outputs.	58
12 Standard AI	Configuration of standard analog inputs.	58
13 Standard AO	Configuration of standard analog outputs.	59
20 Start/stop/direction	Start/stop/direction and run/start/jog enable signal source selection; positive/negative reference enable signal source selection.	60
21 Start/stop mode	Start and stop modes; emergency stop mode and signal source selection; DC magnetization settings; autophasing mode selection.	61
22 Speed reference selection	Speed reference selection; motor potentiometer settings.	63
23 Speed reference ramp	Speed reference ramp settings (programming of the acceleration and deceleration rates for the drive).	64
25 Speed control	Speed controller settings.	65
26 Torque reference chain	Settings for the torque reference chain.	66
30 Limits	Drive operation limits.	66
31 Fault functions	Configuration of external events; selection of behavior of the drive upon fault situations.	67
40 Process PID set 1	Parameter values for process PID control.	68
45 Energy efficiency	Settings for the energy saving calculators.	69
46 Monitoring/scaling settings	Speed supervision settings; actual signal filtering; general scaling settings.	69
50 Fieldbus adapter (FBA)	Fieldbus communication configuration.	70
51 FBA A settings	Fieldbus adapter A configuration.	72
52 FBA A data in	Selection of data to be transferred from drive to fieldbus controller through fieldbus adapter A.	73
53 FBA A data out	Selection of data to be transferred from fieldbus controller to drive through fieldbus adapter A.	73
58 Embedded fieldbus	Configuration of the embedded fieldbus (EFB) interface.	74
74 Trickle Current	Trickle Current Configuration	79
75 De-Ice Function	De-Ice Configuration	80
76 CTDD Motor Control	Motor Control Setup	80
90 Feedback selection	Motor and load feedback configuration.	80
96 System	Language selection; access levels; macro selection; parameter save and restore; control unit reboot; user parameter sets; unit selection; data logger triggering; parameter checksum calculation; user lock.	81
99 Motor data	Motor configuration settings.	82



## Parameter listing

No.	Name/Value	Description	Def/FbEq16
<b>06 Control and status words</b>		Drive control and status words.	
06.11	Main status word	Main status word of the drive. - / uint16 The bit assignments are described on page 661. The related control word and state diagram are presented on pages 659 and 662. Note: In fieldbus control, this parameter value is not exactly the same as the status word that the drive sends to the PLC. See parameter 50.12 FBA A debug mode. This parameter is read-only.	- / uint16
Bit	Name	Description	Value
0	Ready to switch ON	Ready to switch ON	1
		Not ready to switch ON	0
1	Ready run	Ready to operate	1
		OFF1 active	0
2	Ready ref	Operation enabled	1
		Operation inhibited	0
3	Tripped	Fault	1
		No Fault	0
4	OFF2 inactive	OFF2 inactive	1
		OFF2 active	0
5	OFF3 inactive	OFF3 inactive	1
		OFF3 active	0
6	Switch-on inhibited	Switch-on inhibited	1
		--	0
7	Warning	Warning active	1
		No warning active	0
8	At setpoint	Operating - Actual value equals reference = is within tolerance limits (see parameters 46.21 - 46.23)	1
		Actual value differs from reference = is outside tolerance limits	0
9	Remote	Drive control location: Remote (EXT1 or EXT2)	1
		Drive control location: Local	0
10	Trickle Current Active	Trickle Current ON	1
		Trickle Current OFF	0
11	De-Ice Mode Active	De-Ice Mode ON	1
		De-Ice Mode OFF	0
12	CTDD Run	CTDD Running	1
		CTDD Not Running	0
13	CTDD HOLD	CTDD Autophase ON	1
		CTDD Autophase OFF	0
14	Trickle Rotate Active	Trickle Current Rotation Enabled	1
		Trickle current Rotation Disabled	0
15	Reserved		

## 58 Parameters

No.	Name/Value	Description	Def/FbEq16
06.25	Drive inhibit status word 2	Drive inhibit status word 2. This word specifies the source of the inhibiting condition that is preventing the drive from starting. After the condition is removed, the start command must be cycled. See bit-specific notes. See also parameter <i>06.18 Start inhibit status word</i> , and <i>06.16 Drive status word 1</i> , bit 1. This parameter is read-only.	-
Bit	Name	Description	Note
0	Follower drive	1 = A follower is preventing the master from starting.	a
1	Application	1 = The application program is preventing the drive from starting.	b
2	Reserved		
3	Encoder feedback	1 = The encoder feedback configuration is preventing the drive from starting.	a
4	Ref source parametrization	1 = A reference source parametrization conflict is preventing the drive from starting.	b
5...15	Reserved		
Notes:			
a	If bit 1 of <i>06.16 Drive status word 1</i> is still set after the removal of the inhibiting condition, and edge triggering is selected for the active external control location, a fresh rising-edge start signal is required. See parameters <i>20.02</i> , <i>20.07</i> and <i>20.19</i> .		
b	If bit 1 of <i>06.16 Drive status word 1</i> is still set after the removal of the inhibiting condition, a fresh rising-edge start signal is required.		
0000h...FFFFh		Start inhibit status word 2.	1 = 1
<b>11 Standard DIO, FI, FO</b>		Configuration of digital input/outputs and frequency inputs/outputs.	
11.05	DIO1 function	Selects whether DIO1 is used as a digital output or input, or a frequency input.	Input
	Output	DIO1 is used as a digital output.	0
	Input	DIO1 is used as a digital input.	1
	Frequency	DIO1 is used as a frequency input.	2
11.09	DIO2 function	Selects whether DIO2 is used as a digital output or input, or a frequency output.	Input
	Output	DIO2 is used as a digital output.	0
	Input	DIO2 is used as a digital input.	1
	Frequency	DIO2 is used as a frequency output.	2
<b>12 Standard AI</b>		Configuration of standard analog inputs.	
12.15	AI1 unit selection	Selects the unit for readings and settings related to analog input AI1. <b>Note:</b> This setting must match the corresponding hardware setting on the drive control unit (see the <i>Hardware manual</i> ). Control board reboot (either by cycling the power or through parameter <i>96.08 Control board boot</i> ) is required to validate any changes in the hardware settings.	V
	V	Volts.	2
	mA	Milliamperes.	10
12.16	AI1 filter time	Defines the filter time constant for analog input AI1.  <b>Note:</b> The signal is also filtered due to the signal interface hardware (Approximately 0.25 ms time constant). This cannot be changed by any parameter.	0.100 s
	0.000...30.000 s	Filter time constant	1000 = 1 s
12.17	AI1 min	Defines the minimum site value for analog input AI1. Set the value actually sent to the drive when the analog signal from plant is wound to its minimum setting. See also parameter <i>12.01 AI tune</i> .	0.000 mA or V

No.	Name/Value	Description	Def/FbEq16
	-22.00...22.000 mA or V	Minimum value of AI1.	1000 = 1 mA or V
12.18	AI1 max	Defines the maximum site value for analog input AI1. Set the value actually sent to the drive when the analog signal from plant is wound to its maximum setting. See also parameter <i>12.01 AI tune</i> .	20.000 mA or 10.000 V
	-22.000...22.000 mA or V	Maximum value of AI1.	1000 = 1 mA or V
12.19	AI1 scaled at AI1 min	Defines the real internal value that corresponds to the minimum analog input AI1 value defined by parameter <i>12.17 AI1 min</i> (Changing the polarity settings of 12.19 and 12.20 can effectively invert the analog input.)	0.000
	-32768.000...32767.000	Real value corresponding to minimum AI1 value.	1 = 1
12.20	AI1 scaled at AI1 max	Defines the real internal value that corresponds to the maximum analog input AI1 value defined by parameter <i>12.18 AI1 max</i> See the drawing at parameter <i>12.19 AI1 scaled at AI1 max</i> .	1500.000; 1800.000 (95.20 b0)
	-32768.000...32767.000	Real value corresponding to maximum AI1 value.	1 = 1
<b>13 Standard AO</b>		Configuration of standard analog outputs.	
13.12	AO1 source	Selects a signal to be connected to analog output AO1. Alternatively, sets the output to excitation mode to feed a constant current to a temperature sensor.	Motor speed used
	Zero	None.	0
	Motor speed used	<i>01.01 Motor speed used.</i>	1
	Output frequency	<i>01.06 Output frequency.</i>	3
	Motor current	<i>01.07 Motor current.</i>	4
	Motor torque	<i>01.10 Motor torque.</i>	6
	DC voltage	<i>01.11 DC voltage.</i>	7
	Power inu out	<i>01.14 Output power.</i>	8
	Speed ref ramp in	<i>23.01 Speed ref ramp input.</i>	10
	Speed ref ramp out	<i>23.02 Speed ref ramp output.</i>	11
	Speed ref used	<i>24.01 Used speed reference.</i>	12
	Torque ref used	<i>26.02 Torque reference used.</i>	13
	Freq ref used	<i>28.02 Frequency ref ramp output.</i>	14
	Process PID out	<i>40.01 Process PID output actual.</i>	16
	Process PID fbk	<i>40.02 Process PID feedback actual.</i>	17
	Process PID act	<i>40.03 Process PID setpoint actual.</i>	18
	Process PID dev	<i>40.04 Process PID deviation actual.</i>	19
	Force Pt100 excitation	The output is used to feed an excitation current to 1...3 Pt100 sensors. See section Motor thermal protection.	20
	Force KTY84 excitation	The output is used to feed an excitation current to a KTY84 sensor. See section Motor thermal protection.	21
	Force PTC excitation	The output is used to feed an excitation current to 1...3 PTC sensors. See section Motor thermal protection.	22
	Force Pt1000 excitation	The output is used to feed an excitation current to 1...3 Pt1000 sensors. See section Motor thermal protection.	23
	AO1 data storage	<i>13.91 AO1 data storage.</i>	37
	AO2 data storage	<i>13.92 AO2 data storage.</i>	38
	Other	Source selection (see Terms and abbreviations).	-

## 60 Parameters

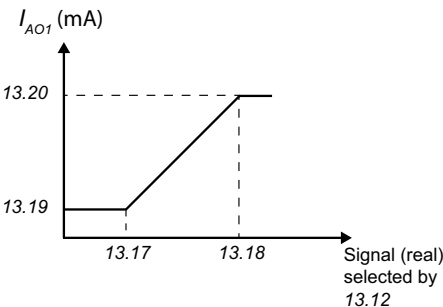
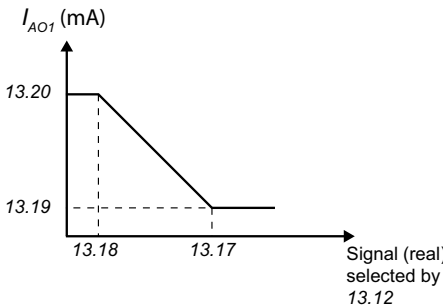
No.	Name/Value	Description	Def/FbEq16
13.17	AO1 source min	<p>Defines the real minimum value of the signal (selected by parameter 13.12) that corresponds to the minimum required AO1 output value (defined by parameter 13.19).</p>  <p>Programming 13.17 as the maximum value and 13.18 as the minimum value inverts the output.</p> 	0.0
	-32768.0...32767.0	Real signal value corresponding to minimum AO1 output value.	1 = 1
13.18	AO1 source max	Defines the real maximum value of the signal (selected by parameter 13.12) that corresponds to the maximum required AO1 output value (defined by parameter 13.20 AO1 out at AO1 src max). See parameter 13.17 AO1 source min.	1500.0; 1800.0 (95.20 b0)
	-32768.0...32767.0	Real signal value corresponding to minimum AO1 output value.	1 = 1
13.19	AO1 out at AO1 src min	Defines the real maximum value of the signal (selected by parameter 13.12) that corresponds to the maximum required AO1 output value (defined by parameter 13.20 AO1 out at AO1 src max). See parameter 13.17 AO1 source min.	0.000 mA
	0.000...22.000 mA	Real signal value corresponding to maximum AO1 output value.	1000 = 1 mA
13.20	AO1 out as AO1 src max	Defines the minimum output value for analog output AO1. See also drawing at parameter 13.17 AO1 source min.	20.000 mA
	0.000...22.000 mA	Maximum AO1 output value.	1000 = 1 mA
13.22	AO2 source min	Selects a signal to be connected to analog output AO2. Alternatively, sets the output to excitation mode to feed a constant current to a temperature sensor. For the selections, see parameter 13.12.	Torque (6)
<b>20 Start/stop/direction</b>		Start/stop/direction and run/start/jog enable signal source selection; positive/negative reference enable signal source selection. For information on control locations, see section Local control vs. external control in the ACS880 Firmware manual.	

No.	Name/Value	Description	Def/FbEq16
20.01	Ext1 commands	Selects the source of start, stop and direction commands for external control location 1 (EXT1). See also parameters 20.02...20.05.	Fieldbus A (12)
	Fieldbus A	The start and stop commands are taken from fieldbus adapter A. Note: The start signal is always level-triggered with this setting regardless of parameter 20.02 Ext1 start trigger type.	12
20.06	Ext2 commands	Selects the source of start, stop and direction commands for external control location 2 (EXT2). See also parameters 20.07...20.10.	Application Program (21)
	Application program	The start and stop commands are taken from the application program control word (parameter 06.02 Application control word). Note: The start signal is always level-triggered with this setting regardless of parameter 20.07 Ext2 start trigger type.	21
20.07	Ext2 start trigger type	Defines whether the start signal for external control location EXT2 is edge-triggered or level-triggered. Note: This parameter is only effective when parameter 20.06 Ext2 commands is set to In1 Start, In1 Start; In2 Dir, In1 Start fwd; In2 Start rev, or Control panel	Level (1)
	Level	The start signal is level-triggered.	1
20.12	Run enable 1 source	Selects the source of the external run enable signal. If the run enable signal is switched off, the drive will not start. If already running, the drive will stop according to the setting of parameter 20.11 Run enable stop mode. 1 = Run enable signal on. Note: The warning that indicates a missing signal can be suppressed using parameter 20.30 Enable signals warning function. See also parameter 20.19 Enable start command.	Selected (1) in 2-wire, 3-wire and PID modes
	Not selected	0	0
	Selected	1	1
<b>21 Start/stop mode</b>		Start and stop modes; emergency stop mode and signal source selection; DC magnetization settings; autophasing mode selection.	
21.01	Start mode	Selects the motor start function for the DTC motor control mode, ie. when 99.04 Motor control mode is set to DTC. <b>Notes:</b> The start function for the scalar motor control mode is selected by parameter 21.19 Scalar start mode. Starting into a rotating motor is not possible when DC magnetizing is selected (Fast or Constant time). With permanent magnet motors and synchronous reluctance motors, Automatic start mode must be used. This parameter cannot be changed while the drive is running. See also section DC magnetization in ACS880 Firmware manual.	Constant time
	Fast	The drive pre-magnetizes the motor before start. The pre-magnetizing time is determined automatically, being typically 200 ms to 2 s depending on motor size. This mode should be selected if a high break-away torque is required.	0
	Constant time	The drive pre-magnetizes the motor before start. The pre-magnetizing time is defined by parameter 21.02 Magnetization time. This mode should be selected if constant pre-magnetizing time is required (e.g. if the motor start must be synchronized with the release of a mechanical brake). This setting also guarantees the highest possible break-away torque when the pre-magnetizing time is set long enough.  <b>WARNING!</b> The drive will start after the set magnetizing time has passed even if motor magnetization is not completed. In applications where a full break-away torque is essential, ensure that the constant magnetizing time is long enough to allow generation of full magnetization and torque.	1

## 62 Parameters

No.	Name/Value	Description	Def/FbEq16
	Automatic	Automatic start guarantees optimal motor start in most cases. It includes the flying start function (starting into a rotating motor) and the automatic restart function (a stopped motor can be restarted immediately without waiting the motor flux to die away). The drive motor control program identifies the flux as well as the mechanical state of the motor and starts the motor instantly under all conditions.	2
	Flying start	This method is intended for asynchronous motors only, and is optimized for applications where the drive must be started into a rotating motor at high frequencies (above 150 Hz).	3
21.03	Stop mode	Selects the way the motor is stopped when a stop command is received. Additional braking is possible by selecting flux braking (see parameter <i>97.05 Flux braking</i> ). <b>NOTE:</b> This parameter has no effect in a follower drive in a master/follower configuration.	Ramp
	Coast	Stop by switching off the output semiconductors of the drive. The motor coasts to a stop.  <b>WARNING!</b> If a mechanical brake is used, ensure it is safe to stop the drive by coasting.	0
	Ramp	Stop along the active deceleration ramp. See parameter <i>Group 23 Speed reference ramp</i> on page 64.	1
	Torque limit	Stop according to torque limits (parameters <i>30.19</i> and <i>30.20</i> ).	2
21.05	Emergency stop source	Selects the source of the emergency stop signal. The stop mode is selected by parameter <i>21.04 Emergency stop mode</i> . 0 = Emergency stop active 1 = Normal operation <b>NOTE:</b> This parameter cannot be changed while the drive is running.	D11L; (95.20 b1, 95.20 b2)
	Active (false)	0.	0
	Inactive (true)	1.	1
	D11L	D11L input ( <i>10.02 DI delayed status</i> , bit 15).	2
	DI1	Digital input DI1 ( <i>10.02 DI delayed status</i> , bit 0).	3
	DI2	Digital input DI2 ( <i>10.02 DI delayed status</i> , bit 1).	4
	DI3	Digital input DI3 ( <i>10.02 DI delayed status</i> , bit 2).	5
	DI4	Digital input DI4 ( <i>10.02 DI delayed status</i> , bit 3).	6
	DI5	Digital input DI5 ( <i>10.02 DI delayed status</i> , bit 4).	7
	DI6	Digital input DI6 ( <i>10.02 DI delayed status</i> , bit 5).	8
	DIO1	Digital input/output DIO1 ( <i>11.02 DIO delayed status</i> , bit 0).	11
	DIO2	Digital input/output DIO2 ( <i>11.02 DIO delayed status</i> , bit 1).	12
	Other [bit]	Source selection	-
21.13	Autophasing mode	Selects the way autophasing is performed. See section <i>Autophasing</i> in the Firmware manual. Note: This parameter cannot be changed while the drive is running.	Turning
	Turning	This mode gives the most accurate autophasing result. This mode can be used, and is recommended, if the motor is allowed to rotate and the start-up is not time-critical. Note: This mode will cause the motor to rotate. The load torque must be less than 5%.	0
	Standstill 1	Faster than the Turning mode, but not as accurate. The motor will not rotate.	1
	Standstill 2	An alternative standstill autophasing mode that can be used if the Turning mode cannot be used, and the Standstill 1 mode gives erratic results. However, this mode is considerably slower than Standstill 1.	2

No.	Name/Value	Description	Def/FbEq16
	Turning with Z-Pulse	This mode should be used if the zero pulse signal of the pulse encoder is to be observed, and other modes do not give a result. The motor will turn until a zero pulse is detected.	3
<b>22 Speed reference selection</b>		Speed reference selection; motor potentiometer settings. See the control chain diagrams in the <i>ACS880 Firmware manual</i> .	
22.22	Constant speed sel1	When bit 0 of parameter <i>22.21 Constant speed function</i> is 0 (Separate), selects a source that activates constant speed 1.	Controlled by Application Program
	Not selected	0 (always off).	0
	Selected	1 (always on).	1
	DI1	Digital input DI1 ( <i>10.02 DI delayed status</i> , bit 0).	2
	DI2	Digital input DI2 ( <i>10.02 DI delayed status</i> , bit 1).	3
	DI3	Digital input DI3 ( <i>10.02 DI delayed status</i> , bit 2).	4
	DI4	Digital input DI4 ( <i>10.02 DI delayed status</i> , bit 3).	5
	DI5	Digital input DI5 ( <i>10.02 DI delayed status</i> , bit 4).	6
	DI6	Digital input DI6 ( <i>10.02 DI delayed status</i> , bit 5).	7
	DIO1	Digital input/output DIO1 ( <i>11.02 DIO delayed status</i> , bit 0).	10
	DIO2	Digital input/output DIO2 ( <i>11.02 DIO delayed status</i> , bit 1).	11
	Other [bit]	Source selection (see Terms and abbreviations on page 114).	-
22.23	Constant speed sel2	When bit 0 of parameter <i>22.21 Constant speed function</i> is 0 (Separate), selects a source that activates constant speed 2.	DI4
22.52	Critical speed 1 low	Defines the low limit for critical speed range 1. <b>NOTE:</b> This value must be less than or equal to the value of parameter 22.53.	0.00 rpm
	-30000.00 ... 30000.00 rpm	Low limit for critical speed 1.	See par. 46.01
22.53	Critical speed 1 high	Defines the high limit for critical speed range 1. <b>NOTE:</b> This value must be greater than or equal to the value of 22.52.	0.00 rpm
	-30000.00 ... 30000.00 rpm	High limit for critical speed 1.	See par. 46.01
22.54	Critical speed 2 low	Defines the low limit for critical speed range 2. <b>NOTE:</b> This value must be less than or equal to the value of parameter 22.55.	0.00 rpm
	-30000.00 ... 30000.00 rpm	Low limit for critical speed 2.	See par. 46.01
22.55	Critical speed 2 high	Defines the high limit for critical speed range 2. <b>NOTE:</b> This value must be greater than or equal to the value of parameter 22.54.	0.00 rpm
	-30000.00 ... 30000.00 rpm	High limit for critical speed 2.	See par. 46.01
22.56	Critical speed 3 low	Defines the low limit for critical speed range 3. <b>NOTE:</b> This value must be less than or equal to the value of parameter 22.57.	0.00 rpm
	-30000.00 ... 30000.00 rpm	Low limit for critical speed 3.	See par. 46.01
22.57	Critical speed 3 high	Defines the high limit for critical speed range 3. <b>NOTE:</b> This value must be greater than or equal to the value of parameter 22.56.	0.00 rpm
	-30000.00 ... 30000.00 rpm	High limit for critical speed 3.	See par. 46.01

## 64 Parameters

No.	Name/Value	Description	Def/FbEq16
22.81	Speed reference act 1	Displays the value of speed reference source 1 (selected by parameter <i>22.11 Speed ref1 source</i> ). See the control chain diagram in the Firmware manual. This parameter is read-only.	-
	-30000.00 ... 30000.00 rpm	Value of reference source 1.	See par. 46.01
22.82	Speed reference act 2	Displays the value of speed reference source 2 (selected by parameter <i>22.12 Speed ref2 source</i> ). See the control chain diagram in the ACS880 Firmware manual. This parameter is read-only.	-
	-30000.00 ... 30000.00 rpm	Value of reference source 2.	See par. 46.01
22.83	Speed reference act 3	Displays the value of speed reference after the mathematical function applied by parameter <i>22.13 Speed ref1 function</i> and reference 1/2 selection ( <i>22.14 Speed ref1/2 selection</i> ). See the control chain diagram in the Firmware manual. This parameter is read-only.	-
	-30000.00 ... 30000.00 rpm	Speed reference after source selection.	See par. 46.01
22.84	Speed reference act 4	Displays the value of speed reference after application of 1st speed additive ( <i>22.15 Speed additive 1 source</i> ). See the control chain diagram in the Firmware manual. This parameter is read-only.	-
	-30000.00 ... 30000.00 rpm	Speed reference after additive 1.	See par. 46.01
<b>23 Speed reference ramp</b>		Speed reference ramp settings (programming of the acceleration and deceleration rates for the drive).	
23.11	Ramp set selection	Selects the source that switches between the two sets of acceleration/ deceleration ramp times defined by parameters <i>23.12...23.15</i> . 0 = Acceleration time 1 and deceleration time 1 are active 1 = Acceleration time 2 and deceleration time 2 are active	DI3; Acc/Dec time 2 (95.20 b1)
	Acc/Dec time 1	0.	0
	Acc/Dec time 2	1.	1
	DI1	Digital input DI1 ( <i>10.02 DI delayed status</i> , bit 0).	2
	DI2	Digital input DI2 ( <i>10.02 DI delayed status</i> , bit 1).	3
	DI3	Digital input DI3 ( <i>10.02 DI delayed status</i> , bit 2).	4
	DI4	Digital input DI4 ( <i>10.02 DI delayed status</i> , bit 3).	5
	DI5	Digital input DI5 ( <i>10.02 DI delayed status</i> , bit 4).	6
	DI6	Digital input DI6 ( <i>10.02 DI delayed status</i> , bit 5).	7
	DIO1	Digital input/output DIO1 ( <i>11.02 DIO delayed status</i> , bit 0).	10
	DIO2	Digital input/output DIO2 ( <i>11.02 DIO delayed status</i> , bit 1).	11
	Other [bit]	Source selection	-
23.12	Acceleration time 1	Defines acceleration time 1 as the time required for the speed to change from zero to the speed defined by parameter <i>46.01 Speed scaling</i> (not to parameter <i>30.12</i> ). If the speed reference increases faster than the set acceleration rate, the motor speed will follow the acceleration rate. If the speed reference increases slower than the set acceleration rate, the motor speed will follow the reference. If the acceleration time is set too short, the drive will automatically prolong the acceleration in order not to exceed the drive torque limits.	20.000 s
	5.000 ... 1800.000 s	Acceleration time 1.	10 = 1 s



No.	Name/Value	Description	Def/FbEq16
23.13	Deceleration time 1	<p>Defines deceleration time 1 as the time required for the speed to change from the speed defined by parameter 46.01 (<b>not</b> from parameter 30.12) to zero.</p> <p>If the speed reference decreases slower than the set deceleration rate, the motor speed will follow the reference.</p> <p>If the reference changes faster than the set deceleration rate, the motor speed will follow the deceleration rate.</p> <p>If the deceleration rate is set too short, the drive will automatically prolong the deceleration in order not to exceed drive torque limits (or not to exceed a safe DC link voltage). If there is any doubt about the deceleration time being too short, ensure that DC overvoltage control is on (parameter 30.30).</p> <p><b>NOTE:</b> If a short deceleration time is needed for a high inertia application, the drive should be equipped with braking equipment such as a brake chopper and brake resistor.</p>	60.0 s
	0.000 ...1800.000 s	Deceleration time 1.	10 = 1 s
23.14	Acceleration time 2	Defines acceleration time 2. See parameter 23.12	60.000 s
	5.000 ...1800.000 s	Acceleration time 2.	10 = 1 s
23.15	Deceleration time 2	Defines deceleration time 2. See parameter 23.13	60.000 s
	0.000 ...1800.000 s	Deceleration time 2.	10 = 1 s
<b>25 Speed control</b>		Speed controller settings.	
25.02	Speed proportional gain	<p>Defines the proportional gain (<math>K_p</math>) of the speed controller. Too high a gain may cause speed oscillation. The figure below shows the speed controller output after an error step when the error remains constant.</p>	0.5; 5.00 (95.21 b1/ b2)
		<p>If gain is set to 1.00, a 10% error (reference - actual value) in the motor synchronous speed produces a proportional term of 10%.</p> <p><b>NOTE:</b> This parameter is automatically set by the speed controller autotune function. See section <i>Speed controller autotune</i> in the Firmware manual.</p>	
	0.00 ...250.00	Proportional gain for speed controller.	100 = 1

No.	Name/Value	Description	Def/FbEq16
25.03	Speed integration time	<p>Defines the integration time of the speed controller. The integration time defines the rate at which the controller output changes when the error value is constant and the proportional gain of the speed controller is 1. The shorter the integration time, the faster the continuous error value is corrected.</p> <p>Setting the integration time to zero disables the I-part of the controller. This is useful to do when tuning the proportional gain; adjust the proportional gain first, then return the integration time.</p> <p>The integrator has anti-windup control for operation at a torque or current limit.</p> <p>The figure below shows the speed controller output after an error step when the error remains constant.</p>	4.0 s; 5.00 s (95.21 b1/b2)
		<p><b>NOTE:</b> This parameter is automatically set by the speed controller autotune function. See section <i>Speed controller autotune</i> in the ACS880 Firmware manual.</p>	
	0.00 ... 1000.00 s	Integration time for speed controller.	10 = 1 s
25.15	Proportional gain em stop	Defines the proportional gain for the speed controller when an emergency stop is active. See parameter 25.02.	1.00; 5.00 (95.21 b1/b2)
	1.00 ... 250.00	Proportional gain upon an emergency stop.	100 = 1
<b>26 Torque reference chain</b>		Settings for the torque reference chain.	
26.81	Rush control gain	Rush controller gain term. See section <i>Rush control</i> in the ACS880 Firmware manual.	0.0
	0.0 ...10000.0	Rush controller gain (0.0 = disabled).	1 = 1
26.82	Rush control integration time	Rush controller integration time term.	0.0 s
	0.0 ... 10.0 s	Rush controller integration time (0.0 = disabled).	1 = 1 s
<b>30 Limits</b>		Drive operation limits.	
30.12	Maximum speed	<p>Defines the maximum allowed speed. This parameter is set automatically based from the motor base speed and can't be changed. (Read Only)</p> <p><b>WARNING!</b> This value must not be lower than 31.11.</p>	1000 rpm; (95.20 b0)
	-1000.00...1000.00 rpm	Maximum speed.	See par. 46.01



No.	Name/Value	Description	Def/FbEq16
30.19	Minimum torque 1	Defines a minimum torque limit for the drive (in percent of nominal motor torque). See diagram at parameter <i>30.18 Minimum torque sel</i> . The limit is effective when <ul style="list-style-type: none"> <li>the source selected by <i>30.18 Minimum torque sel</i> is 0, or</li> <li><i>30.18</i> is set to Minimum torque 1.</li> </ul> Note: Do not set this parameter to 0% in an attempt to prevent reverse rotation. In an open-loop application, that is likely to prevent the motor from stopping altogether. To prevent reverse rotation, use the speed/frequency limits in this parameter group, or parameters <i>20.23/20.24</i> .	
	-1600.0 ...0%	Minimum torque 1. For scaling, see parameter 46.3.	-50
30.20	Maximum torque 1	Defines a maximum torque limit for the drive (in percent of nominal motor torque). See diagram at parameter <i>30.18 Minimum torque sel</i> . The limit is effective when <ul style="list-style-type: none"> <li>the source selected by <i>30.25 Maximum torque sel</i> is 0, or</li> <li><i>30.25</i> is set to Maximum torque 1.</li> </ul>	
	0% ... 1600.0%	Maximum torque 1. For scaling, see parameter 46.3.	110
30.30	Overvoltage control	Enables the overvoltage control of the intermediate DC link. Fast braking of a high inertia load causes the voltage to rise to the overvoltage control limit. To prevent the DC voltage from exceeding the limit, the overvoltage controller automatically decreases the braking torque. <b>Note:</b> If the drive is equipped with a brake chopper and resistor, or a regenerative supply unit, the controller must be disabled.	Enable
	Disable	Overvoltage control disabled.	0
	Enable	Overvoltage control enabled.	1
<b>31 Fault functions</b>		Configuration of external events; selection of behavior of the drive upon fault situations.	
31.01	External event 1 source	Defines the source of external event 1. See also parameter <i>31.02 External event 1 type</i> . 0 = Trigger event 1 = Normal operation	<i>DI6 (95.20 b8)</i>
	Active (false)	0.	0
	Inactive (true)	1.	1
	DIIL	DIIL input ( <i>10.02 DI delayed status</i> , bit 15).	2
	DI1	Digital input DI1 ( <i>10.02 DI delayed status</i> , bit 0).	3
	DI2	Digital input DI2 ( <i>10.02 DI delayed status</i> , bit 1).	4
	DI3	Digital input DI3 ( <i>10.02 DI delayed status</i> , bit 2).	5
	DI4	Digital input DI4 ( <i>10.02 DI delayed status</i> , bit 3).	6
	DI5	Digital input DI5 ( <i>10.02 DI delayed status</i> , bit 4).	7
	DI6	Digital input DI6 ( <i>10.02 DI delayed status</i> , bit 5).	8
	DIO1	Digital input/output DIO1 ( <i>11.02 DIO delayed status</i> , bit 0).	11
	DIO2	Digital input/output DIO2 ( <i>11.02 DIO delayed status</i> , bit 1).	12
	Other [bit]	Source selection	-
31.11	Fault reset selection	Selects the source of an external fault reset signal. This signal will be observed even if it is not the active source in the current control location (EXT1/EXT2/Local). (A reset from the active source will be observed regardless of this parameter.) 0 → 1 = Reset	DI5
	Not selected	0.	0
	Selected	1.	1
	DI1	Digital input DI1 ( <i>10.02 DI delayed status</i> , bit 0).	2
	DI2	Digital input DI2 ( <i>10.02 DI delayed status</i> , bit 1).	3

## 68 Parameters

No.	Name/Value	Description	Def/FbEq16
	DI3	Digital input DI3 ( <i>10.02 DI delayed status</i> , bit 2).	4
	DI4	Digital input DI4 ( <i>10.02 DI delayed status</i> , bit 3).	5
	DI5	Digital input DI5 ( <i>10.02 DI delayed status</i> , bit 4).	6
	DI6	Digital input DI6 ( <i>10.02 DI delayed status</i> , bit 5).	7
	DIO1	Digital input/output DIO1 ( <i>11.02 DIO delayed status</i> , bit 0).	10
	DIO2	Digital input/output DIO2 ( <i>11.02 DIO delayed status</i> , bit 1).	11
	FBA A MCW bit 7	Control word bit 7 received through fieldbus interface A.	30
	EFB MCW bit 7	Control word bit 7 received through the embedded fieldbus interface.	32
	Other [bit]	Source selection	-
<b>40 Process PID set 1</b>		<p>Parameter values for process PID control.</p> <p>The drive contains a single active PID controller for process use, however two separate complete set-ups can be programmed and stored.</p> <p>The first set is made up of parameters <i>40.07...40.56*</i>, the second set is defined by the parameters in group <i>41 Process PID set 2</i>. The binary source that defines which set is used is selected by parameter <i>40.57 PID set1/set2 selection</i>.</p> <p>See section <i>Process PID control</i>, and the control chain diagrams in the <i>ACS880 Firmware manual</i>.</p> <p>*The remaining parameters in this group are common for both sets.</p>	
40.08	Set 1 feedback 1 source	Selects the first source of process feedback. See the control chain diagram in the <i>ACS880 Firmware manual</i> .	AI2 scaled
	Not selected	None.	0
	AI1 scaled	<i>12.12 AI1 scaled value</i> .	1
	AI2 scaled	<i>12.22 AI2 scaled value</i> .	2
	Freq in scaled	<i>11.39 Freq in 1 scaled</i> .	3
	Motor current	<i>01.07 Motor current</i> .	5
	Power inu out	<i>01.14 Output power</i> .	6
	Motor torque	<i>01.10 Motor torque</i> .	7
	Feedback data storage	<i>40.91 Feedback data storage</i> .	10
	Other	Source selection	-
40.11	Set 1 feedback filter time	Defines the filter time constant for process feedback.	0.04 s
	0.000 ... 30.000 s	Feedback filter time.	1 = 1 s
40.12	Set 1 unit selection	Defines the unit for parameters <i>40.01...40.05</i> , <i>40.21...40.24</i> and <i>40.47</i> .	%
	rpm	rpm.	7
	%	%.	4
	Hz	Hz.	3
	PID user unit 1	User-definable unit 1. The name of the unit can be edited on the control panel by choosing Menu – Settings – Edit texts.	250
40.14	Set 1 setpoint scaling	<p>Defines, together with parameter <i>40.15 Set 1 output scaling</i>, a general scaling factor for the process PID control chain.</p> <p>The scaling can be utilized when, for example, the process setpoint is input in Hz, and the output of the PID controller is used as an rpm value in speed control. In this case, this parameter might be set to 50, and parameter <i>40.15</i> to the nominal motor speed at 50 Hz.</p> <p>In effect, the output of the PID controller = <math>[40.15]</math> when deviation (setpoint - feedback) = <math>[40.14]</math> and <math>[40.32] = 1</math>.</p> <p><b>NOTE:</b> The scaling is based on the ratio between <i>40.14</i> and <i>40.15</i>. For example, the values 50 and 1500 would produce the same scaling as 1 and 30.</p>	100.00
	-32768.00 ... 32767.00	Process setpoint base.	1 = 1

No.	Name/Value	Description	Def/FbEq16
40.16	Set 1 setpoint 1 source	Selects the first source of process PID setpoint. This setpoint is available in parameter <i>40.25 Set 1 setpoint selection</i> as setpoint 1. See the control chain diagram in the <i>Firmware manual</i> .	AI1 scaled value
	Not selected	None.	0
	Control panel	<i>03.01 Panel reference</i> . See section <i>Using the control panel as an external control source</i> .	1
	Internal setpoint	Internal setpoint. See parameter <i>40.19 Set 1 internal setpoint sel1</i> .	2
	AI1 scaled	<i>12.12 AI1 scaled value</i> .	3
	AI2 scaled	<i>12.22 AI2 scaled value</i> .	4
	Motor potentiometer	<i>22.80 Motor potentiometer ref act</i> (output of the motor potentiometer).	8
	Freq in scaled	<i>11.39 Freq in 1 scaled</i> .	10
	Setpoint data storage	<i>40.92 Setpoint data storage</i> .	24
	Other	Source selection	-
40.17	Set 1 setpoint 2 source	Selects the second source of process setpoint. This setpoint is available in parameter <i>40.25 Set 1 setpoint selection</i> as setpoint 2. For the selections, see parameter 40.16 Set 1 setpoint 1 source.	Internal Setpoint
40.26	Set 1 setpoint min	Defines a minimum limit for the process PID controller setpoint.	0.00
	-32768.00 ... 32767.00	Minimum limit for process PID controller setpoint.	1 = 1
40.27	Set 1 setpoint max	Defines a maximum limit for the process PID controller setpoint.	100
	-32768.00 ... 32767.00	Maximum limit for process PID controller setpoint.	1 = 1
<b>45 Energy efficiency</b>		Settings for the energy saving calculators. See also section Energy saving calculators.	
45.17	Tariff currency unit	Specifies the currency used for the savings calculations.	102
	Local currency	Local currency. The name of the currency can be edited by choosing Menu - Settings - Edit texts on the control panel.	100
	EUR	Euro.	101
	USD	US dollar.	102
<b>46 Monitoring/scaling settings</b>		Speed supervision settings; actual signal filtering; general scaling settings. <b>NOTE:</b> The 16-bit scalings apply when parameter values are read or written directly. With protocol- and profile-specific read/write commands (eg. communication objects), the scaling depends on the protocol or profile. See the documentation of the adapter module.	
46.01	Speed scaling	Defines the maximum speed value used to define the acceleration ramp rate and the initial speed value used to define the deceleration ramp rate (see parameter group <i>Group 23 Speed reference ramp</i> ). The speed acceleration and deceleration ramp times are therefore related to this value ( <b>not</b> to parameter <i>30.12</i> ). Also defines the 16-bit scaling of speed-related parameters. The value of this parameter corresponds to 20000 in fieldbus, master/follower etc. communication.	1500.00 rpm; (95.20 b0)
	0.10 ... 30000.00 rpm	Acceleration/deceleration terminal/initial speed.	1 = 1 rpm
46.02	Frequency scaling	Defines the maximum frequency value used to define the acceleration ramp rate and the initial frequency value used to define deceleration ramp rate (see parameter group <i>28 Frequency reference chain</i> ). The frequency acceleration and deceleration ramp times are therefore related to this value (not to parameter <i>30.14 Maximum frequency</i> ). Also defines the 16-bit scaling of frequency-related parameters. The value of this parameter corresponds to 20000 in fieldbus, master/follower etc. communication.	50.00 Hz; 60.00 Hz (95.20 b0)
	0.10 ... 1000.00 Hz	Acceleration/deceleration terminal/initial frequency.	10 = 1 Hz
46.03	Torque scaling	Defines the 16-bit scaling of torque parameters. The value of this parameter (in percent of nominal motor torque) corresponds to 10000 in fieldbus, master/follower etc. communication. See also parameter <i>46.42 Torque decimals</i> .	100.0%

## 70 Parameters

No.	Name/Value	Description	Def/FbEq16
	0.1 ... 1000.0%	Torque corresponding to 10000 on fieldbus.	10 = 1%
46.11	Filter time motor speed	Defines a filter time for signals <i>01.01 Motor speed used</i> , <i>01.02 Motor speed estimated</i> , <i>01.04 Encoder 1 speed filtered</i> and <i>01.05 Encoder 2 speed filtered</i> .	10
	0...20000 ms	Motor speed signal filter time.	1 = 1 ms
46.13	Filter time motor torque	Defines a filter time for signal <i>01.10 Motor torque</i> .	10
	0...20000 ms	Motor torque signal filter time.	1 = 1 ms
<b>50 Fieldbus adapter (FBA)</b>		Fieldbus communication configuration.	
50.01	FBA A enable	Enables/disables communication between the drive and fieldbus adapter A, and specifies the slot the adapter is installed into. <b>NOTE:</b> This parameter cannot be changed while the drive is running.	Disable
	Disable	Communication between drive and fieldbus adapter A disabled.	0
	Option slot 1	Communication between drive and fieldbus adapter A enabled. The adapter is in slot 1.	1
	Option slot 2	Communication between drive and fieldbus adapter A enabled. The adapter is in slot 2.	2
	Option slot 3	Communication between drive and fieldbus adapter A enabled. The adapter is in slot 3.	3
50.02	FBA A comm loss func	Selects how the drive reacts upon a fieldbus communication break. A time delay for the action can be defined by parameter 50.03. See also parameter 50.26 <i>FBA A comm supervision force</i> .	No action
	No action	No action taken.	0
	Fault	Drive trips on 7510 FBA A communication. This only occurs if control is expected from the FBA A interface (FBA A selected as source of start/stop/reference in the currently active control location), or if supervision is forced using parameter 50.26 <i>FBA A comm supervision force</i> .	1
	Last speed	Drive generates an A7C1 FBA A communication warning and freezes the speed to the level the drive was operating at. This only occurs if control is expected from the FBA A interface, or if supervision is forced using parameter 50.26 <i>FBA A comm supervision force</i> . The speed is determined on the basis of actual speed using 850 ms low-pass filtering.  <b>WARNING!</b> Make sure that it is safe to continue operation in case of a communication break.	2
	Speed ref safe	Drive generates an A7C1 FBA A communication warning and sets the speed to the value defined by parameter 22.41 <i>Speed ref safe</i> (when speed reference is being used) or 28.41 <i>Frequency ref safe</i> (when frequency reference is being used). This only occurs if control is expected from the FBA A interface, or if supervision is forced using parameter 50.26 <i>FBA A comm supervision force</i> .  <b>WARNING!</b> Make sure that it is safe to continue operation in case of a communication break.	3
	Fault always	Drive trips on 7510 FBA A communication. This occurs even though no control is expected from the FBA A interface.	4
	Warning	Drive generates an A7C1 FBA A communication warning. This only occurs if control is expected from the FBA A interface, or if supervision is forced using parameter 50.26 <i>FBA A comm supervision force</i> .  <b>WARNING!</b> Make sure that it is safe to continue operation in case of a communication break.	5

No.	Name/Value	Description	Def/FbEq16
50.03	FBA A comm loss t out	Defines the time delay before the action defined by parameter <i>50.02 FBA A comm loss func</i> is taken. Time count starts when the communication link fails to update the message. As a rule of thumb, this parameter should be set to at least 3 times the transmit interval of the master. <b>NOTE:</b> There is a 60-second boot-up delay immediately after power-up. During the delay, the communication break monitoring is disabled (but communication itself can be active).	0.3 s
	0.3 ... 6553.5 s	Time delay.	1 = 1 s
50.04	FBA A ref1 type	Selects the type and scaling of reference 1 received from fieldbus adapter A. <b>NOTE:</b> Fieldbus-specific communication profiles may use different scalings. For more information, see the manual of the fieldbus adapter.	Speed
	Auto	Type and scaling are chosen automatically according to which reference chain (see settings Torque, Speed, Frequency) the incoming reference is connected to. If the reference is not connected to any chain, no scaling is applied (as with setting Transparent).	0
	Transparent	No scaling is applied (the 16-bit scaling is 1 = 1 unit).	1
	General	Generic reference with a 16-bit scaling of 100 = 1 (ie. integer and two decimals).	2
	Torque	The scaling is defined by parameter <i>46.03</i> .	3
	Speed	The scaling is defined by parameter <i>46.01</i> .	4
	Frequency	The scaling is defined by parameter <i>46.02</i> .	5
50.05	FBA A ref2 type	Selects the type and scaling of reference 2 received from fieldbus adapter A. See parameter <i>50.04</i> .	Auto
50.07	FBA A actual 1 type	Selects the type/source and scaling of actual value 1 transmitted to the fieldbus network through fieldbus adapter A. <b>NOTE:</b> Fieldbus-specific communication profiles may use different scalings. For more information, see the manual of the fieldbus adapter.	Auto
	Auto	Type/source and scaling follow the type of reference 1 selected by parameter <i>50.04</i> . See the individual settings below for the sources and scalings.	0
	Transparent	The value selected by parameter <i>50.10</i> is sent as actual value 1. No scaling is applied (the 16-bit scaling is 1 = 1 unit).	1
	General	The value selected by parameter <i>50.10</i> is sent as actual value 1 with a 16-bit scaling of 100 = 1 unit (ie. integer and two decimals).	2
	Torque	<i>01.10 Motor torque</i> is sent as actual value 1. The scaling is defined by parameter <i>46.03</i> .	3
	Speed	<i>01.01 Motor speed used</i> is sent as actual value 1. The scaling is defined by parameter <i>46.01</i> .	4
	Frequency	<i>01.06 Output frequency</i> is sent as actual value 1. The scaling is defined by parameter <i>46.02</i> .	5
	Position	Motor position is sent as actual value 1. See parameter <i>90.06 Motor position scaled</i> .	6
50.08	FBA A actual 2 type	Selects the type/source and scaling of actual value 2 transmitted to the fieldbus network through fieldbus adapter A. See parameter <i>50.07</i> .	Torque
50.09	FBA A SW transparent source	Selects the source of the fieldbus status word when the fieldbus adapter is set to a transparent communication profile eg. by its configuration parameters (group <i>Group 51 FBA A settings</i> ).	6.11[16]
	Not selected	No source selected.	-
	Other	Source selection	-

## 72 Parameters

No.	Name/Value	Description	Def/FbEq16
50.10	FBA A act1 transparent source	When parameter 50.07 is set to Transparent or General, this parameter selects the source of actual value 1 transmitted to the fieldbus network through fieldbus adapter A.	Not selected
	Not selected	No source selected.	-
	Other	Source selection	-
50.11	FBA A act2 transparent source	When parameter 50.08 is set to Transparent or General, this parameter selects the source of actual value 2 transmitted to the fieldbus network through fieldbus adapter A.	Not selected
	Not selected	No source selected.	-
	Other	Source selection	-
<b>51 FBA A settings</b>		Fieldbus adapter A configuration.	
51.01	FBA A type	Displays the type of the connected fieldbus adapter module. <b>0</b> = Module is not found or is not properly connected, or is disabled by parameter 50.01 FBA A enable; <b>1</b> = FPBA; <b>32</b> = FCAN; <b>37</b> = FDNA; <b>101</b> = FCNA, <b>128</b> = FENA-11/21; <b>135</b> = FECA; <b>136</b> = FEPL; <b>485</b> = FSCA. This parameter is read-only.	-
51.02	FBA A Par2	Parameters 51.02...51.26 are adapter module-specific. For more information, see the documentation of the fieldbus adapter module. Note that not all of these parameters are necessarily in use.	-
	0...65535	Fieldbus adapter configuration parameter.	1 = 1
...	...	...	...
51.26	FBA A Par26	See parameter 51.02.	-
	0...65535	Fieldbus adapter configuration parameter.	1 = 1
51.27	FBA A par refresh	Validates any changed fieldbus adapter module configuration settings. After refreshing, the value reverts automatically to Done. <b>NOTE:</b> This parameter cannot be changed while the drive is running.	Done
	Done	Refreshing done.	0
	Refresh	Refreshing.	1
51.28	FBA A par table ver	Displays the parameter table revision of the fieldbus adapter module mapping file (stored in the memory of the drive). In format axyz, where ax = major table revision number; yz = minor table revision number. This parameter is read-only.	-
		Parameter table revision of adapter module.	-
51.29	FBA A drive type code	Displays the drive type code in the fieldbus adapter module mapping file (stored in the memory of the drive). This parameter is read-only.	-
	0...65535	Drive type code stored in the mapping file.	1 = 1
51.30	FBA A mapping file ver	Displays the fieldbus adapter module mapping file revision stored in the memory of the drive in decimal format. This parameter is read-only.	-
	0...65535	Mapping file revision.	1 = 1
51.31	D2FBA A comm status	Displays the status of the fieldbus adapter module communication.	-
	Not configured	Adapter is not configured.	0
	Initializing	Adapter is initializing.	1
	Time out	A timeout has occurred in the communication between the adapter and the drive.	2
	Configuration error	Adapter configuration error: mapping file not found in the file system of the drive, or mapping file upload has failed more than three times.	3
	Off-line	Fieldbus communication is off-line.	4



No.	Name/Value	Description	Def/FbEq16
	On-line	Fieldbus communication is on-line, or fieldbus adapter has been configured not to detect a communication break. For more information, see the documentation of the fieldbus adapter.	5
	Reset	Adapter is performing a hardware reset.	6
51.32	FBA A comm SW ver	Displays the patch and build versions of the adapter module firmware in format xyy, where xx = patch version number, yy = build version number. Example: C802 = 200.02 (patch version 200, build version 2).	
		Patch and build versions of adapter module firmware.	-
51.33	FBA A appl SW ver	Displays the major and minor versions of the adapter module firmware in format xyy, where x = major revision number, yy = minor revision number. Example: 300 = 3.00 (major version 3, minor version 00).	
		Major and minor versions of adapter module firmware.	-
<b>52 FBA A data in</b>		Selection of data to be transferred from drive to fieldbus controller through fieldbus adapter A. <b>NOTE:</b> 32-bit values require two consecutive parameters. Whenever a 32-bit value is selected in a data parameter, the next parameter is automatically reserved.	
52.01	FBA A data in1	Parameters 52.01...52.12 select data to be transferred from the drive to the fieldbus controller through fieldbus adapter A.	None
	None	None.	0
	CW 16bit	Control Word (16 bits)	1
	Ref1 16bit	Reference REF1 (16 bits)	2
	Ref2 16bit	Reference REF2 (16 bits)	3
	SW 16bit	Status Word (16 bits)	4
	Act1 16bit	Actual value ACT1 (16 bits)	5
	Act2 16bit	Actual value ACT2 (16 bits)	6
	CW 32bit	Control Word (32 bits)	11
	Ref1 32bit	Reference REF1 (32 bits)	12
	Ref2 32bit	Reference REF2 (32 bits)	13
	SW 32bit	Status Word (32 bits)	14
	Act1 32bit	Actual value ACT1 (32 bits)	15
	Act2 32bit	Actual value ACT2 (32 bits)	16
	SW2 16bit	Status Word 2 (16 bits)	24
	Other	Source selection	-
...	...	...	...
52.12	FBA A data in12	See parameter 52.01.	None
<b>53 FBA A data out</b>		Selection of data to be transferred from fieldbus controller to drive through fieldbus adapter A. <b>NOTE:</b> 32-bit values require two consecutive parameters. Whenever a 32-bit value is selected in a data parameter, the next parameter is automatically reserved.	
53.01	FBA A data out1	Parameters 53.01...53.12 select data to be transferred from the fieldbus controller to the drive through fieldbus adapter A.	None
	None	None.	0
	CW 16bit	Control Word (16 bits)	1
	Ref1 16bit	Reference REF1 (16 bits)	2
	Ref2 16bit	Reference REF2 (16 bits)	3
	CW 32bit	Control Word (32 bits)	11

## 74 Parameters

No.	Name/Value	Description	Def/FbEq16
	Ref1 32bit	Reference REF1 (32 bits)	12
	Ref2 32bit	Reference REF2 (32 bits)	13
	CW2 16bit	Control Word 2 (16 bits)	21
	Other	Source selection	-
...	...	...	...
53.12	FBA A data out12	See parameter 53.01.	None
<b>58 Embedded fieldbus</b>		Configuration of the embedded fieldbus (EFB) interface.	
58.01	Protocol enable	Enables/disables the embedded fieldbus interface and selects the protocol to use. Notes: <ul style="list-style-type: none"> <li>When the embedded fieldbus interface is enabled, the drive-to-drive link functionality is automatically disabled.</li> <li>This parameter cannot be changed while the drive is running.</li> </ul>	None
	None	None (communication disabled).	0
	Modbus RTU	Embedded fieldbus interface is enabled and uses the Modbus RTU protocol.	1
58.02	Protocol ID	Displays the protocol ID and revision. This parameter is read-only.	-
		Protocol ID and revision.	1 = 1
58.03	Node address	Defines the node address of the drive on the fieldbus link. Values 1...247 are allowable. Two devices with the same address are not allowed on-line. Changes to this parameter take effect after the control unit is rebooted or the new settings validated by parameter 58.06.	1
	0...255	Node address (values 1...247 are allowable).	1 = 1
58.04	Baud rate	Selects the transfer rate of the fieldbus link. Changes to this parameter take effect after the control unit is rebooted or the new settings validated by parameter 58.06.	19.2 kbps
	9.6 kbps	9.6 kbit/s.	2
	19.2 kbps	19.2 kbit/s.	3
	38.4 kbps	38.4 kbit/s.	4
	57.6 kbps	57.6 kbit/s.	5
	76.8 kbps	76.8 kbit/s.	6
	115.2 kbps	115.2 kbit/s.	7
58.05	Parity	Selects the type of parity bit and the number of stop bits. Changes to this parameter take effect after the control unit is rebooted or the new settings validated by parameter 58.06.	8 EVEN 1
	8 NONE 1	Eight data bits, no parity bit, one stop bit.	0
	8 NONE 2	Eight data bits, no parity bit, two stop bits.	1
	8 EVEN 1	Eight data bits, even parity bit, one stop bit.	2
	8 ODD 1	Eight data bits, odd parity bit, one stop bit.	3
58.06	Communication control	Validates any changes in the EFB settings, or activates silent mode.	Enabled
	Enabled	Normal operation.	0
	Refresh settings	Validates any changed EFB configuration settings. Reverts automatically to Enabled.	1
	Silent mode	Activates silent mode (no messages are transmitted). Silent mode can be terminated by activating the Refresh settings selection of this parameter.	2

No.	Name/Value	Description	Def/FbEq16																																																			
58.07	Communication diagnostics	Displays the status of the EFB communication. This parameter is read-only.	-																																																			
		<table border="1"> <thead> <tr> <th>Bit</th> <th>Name</th> <th>Description</th> </tr> </thead> <tbody> <tr> <td>0</td> <td>Init failed</td> <td>1 = EFB initialization failed</td> </tr> <tr> <td>1</td> <td>Addr config err</td> <td>1 = Node address not allowed by protocol</td> </tr> <tr> <td>2</td> <td>Silent mode</td> <td>1 = Drive not allowed to transmit 0 = Drive allowed to transmit</td> </tr> <tr> <td>3</td> <td>Autobauding</td> <td>Reserved</td> </tr> <tr> <td>4</td> <td>Wiring error</td> <td>1 = Errors detected (A/B wires possibly swapped)</td> </tr> <tr> <td>5</td> <td>Parity error</td> <td>1 = Error detected: check parameters 58.04 and 58.05</td> </tr> <tr> <td>6</td> <td>Baud rate error</td> <td>1 = Error detected: check parameters 58.05 and 58.04</td> </tr> <tr> <td>7</td> <td>No bus activity</td> <td>1 = 0 bytes received during last 5 seconds</td> </tr> <tr> <td>8</td> <td>No packets</td> <td>1 = 0 packets (addressed to any device) detected during last 5 seconds</td> </tr> <tr> <td>9</td> <td>Noise or addressing error</td> <td>1 = Errors detected (interference, or another device with the same address on line)</td> </tr> <tr> <td>10</td> <td>Comm loss</td> <td>1 = 0 packets addressed to the drive received within timeout (58.16)</td> </tr> <tr> <td>11</td> <td>CW/Ref loss</td> <td>1 = No control word or references received within timeout (58.16)</td> </tr> <tr> <td>12</td> <td>Not active</td> <td>Reserved</td> </tr> <tr> <td>13</td> <td>Protocol 1</td> <td>Reserved</td> </tr> <tr> <td>14</td> <td>Protocol 2</td> <td>Reserved</td> </tr> <tr> <td>15</td> <td>Internal error</td> <td>Reserved</td> </tr> </tbody> </table>	Bit	Name	Description	0	Init failed	1 = EFB initialization failed	1	Addr config err	1 = Node address not allowed by protocol	2	Silent mode	1 = Drive not allowed to transmit 0 = Drive allowed to transmit	3	Autobauding	Reserved	4	Wiring error	1 = Errors detected (A/B wires possibly swapped)	5	Parity error	1 = Error detected: check parameters 58.04 and 58.05	6	Baud rate error	1 = Error detected: check parameters 58.05 and 58.04	7	No bus activity	1 = 0 bytes received during last 5 seconds	8	No packets	1 = 0 packets (addressed to any device) detected during last 5 seconds	9	Noise or addressing error	1 = Errors detected (interference, or another device with the same address on line)	10	Comm loss	1 = 0 packets addressed to the drive received within timeout (58.16)	11	CW/Ref loss	1 = No control word or references received within timeout (58.16)	12	Not active	Reserved	13	Protocol 1	Reserved	14	Protocol 2	Reserved	15	Internal error	Reserved	
Bit	Name	Description																																																				
0	Init failed	1 = EFB initialization failed																																																				
1	Addr config err	1 = Node address not allowed by protocol																																																				
2	Silent mode	1 = Drive not allowed to transmit 0 = Drive allowed to transmit																																																				
3	Autobauding	Reserved																																																				
4	Wiring error	1 = Errors detected (A/B wires possibly swapped)																																																				
5	Parity error	1 = Error detected: check parameters 58.04 and 58.05																																																				
6	Baud rate error	1 = Error detected: check parameters 58.05 and 58.04																																																				
7	No bus activity	1 = 0 bytes received during last 5 seconds																																																				
8	No packets	1 = 0 packets (addressed to any device) detected during last 5 seconds																																																				
9	Noise or addressing error	1 = Errors detected (interference, or another device with the same address on line)																																																				
10	Comm loss	1 = 0 packets addressed to the drive received within timeout (58.16)																																																				
11	CW/Ref loss	1 = No control word or references received within timeout (58.16)																																																				
12	Not active	Reserved																																																				
13	Protocol 1	Reserved																																																				
14	Protocol 2	Reserved																																																				
15	Internal error	Reserved																																																				
	0000h...FFFFh	EFB communication status.	1 = 1																																																			
58.08	Received packets	Displays a count of valid packets addressed to the drive. During normal operation, this number increases constantly. Can be reset from the control panel by keeping Reset depressed for over 3 seconds.	-																																																			
	0...4294967295	Number of received packets addressed to the drive.	1 = 1																																																			
58.09	Transmitted packets	Displays a count of valid packets transmitted by the drive. During normal operation, this number increases constantly. Can be reset from the control panel by keeping Reset depressed for over 3 seconds.	-																																																			
	0...4294967295	Number of transmitted packets.	1 = 1																																																			
58.10	All packets	Displays a count of valid packets addressed to any device on the bus. During normal operation, this number increases constantly. Can be reset from the control panel by keeping Reset depressed for over 3 seconds.	-																																																			
	0...4294967295	Number of all received packets.	1 = 1																																																			
58.11	UART errors	Displays a count of character errors received by the drive. An increasing count indicates a configuration problem on the bus. Can be reset from the control panel by keeping Reset depressed for over 3 seconds.	-																																																			
	0...4294967295	Number of UART errors.	1 = 1																																																			
58.17	Transmit delay	Defines a minimum response delay in addition to any fixed delay imposed by the protocol. Changes to this parameter take effect after the control unit is rebooted or the new settings validated by parameter 58.06.	0 ms																																																			
	0...65535 ms	Minimum response delay.	1 = 1																																																			

## 76 Parameters

No.	Name/Value	Description	Def/FbEq16
58.18	EFB control word	Displays the raw (unmodified) control word sent by the Modbus controller to the drive. For debugging purposes. This parameter is read-only.	-
	0000h...FFFFh	Control word sent by Modbus controller to the drive.	1 = 1
58.19	EFB status word	Displays the raw (unmodified) status word sent by the drive to the Modbus controller. For debugging purposes. This parameter is read-only.	-
	0000h...FFFFh	Status word sent by the drive to the Modbus controller.	1 = 1
58.25	Control profile	Defines the control profile used by the protocol.	ABB Drives
	ABB Drives	ABB Drives profile (with a 16-bit control word) with registers in the classic format for backward compatibility.	0
	Transparent	Transparent profile (16-bit or 32-bit control word) with registers in the classic format.	2
58.26	EFB ref1 type	Selects the type and scaling of reference 1 received through the embedded fieldbus interface. The scaled reference is displayed by <i>03.09 EFB reference 1</i> .	Auto
	Auto	Type and scaling are chosen automatically according to which reference chain (see settings Torque, Speed, Frequency) the incoming reference is connected to. If the reference is not connected to any chain, no scaling is applied (as with setting Transparent).	0
	Transparent	No scaling is applied.	1
	General	Generic reference with a scaling of 100 = 1 (ie. integer and two decimals).	2
	Torque	The scaling is defined by parameter 46.03.	3
	Speed	The scaling is defined by parameter 46.01.	4
	Frequency	The scaling is defined by parameter 46.02.	5
58.27	EFB ref2 type	Selects the type and scaling of reference 2 received through the embedded fieldbus interface. The scaled reference is displayed by <i>03.10 EFB reference 2</i> . For the selections, see parameter 58.26.	Torque
58.28	EFB act1 type	Selects the type/source and scaling of actual value 1 transmitted to the fieldbus network through the embedded fieldbus interface.	Auto
	Auto	Type/source and scaling follow the type of reference 1 selected by parameter 58.26. See the individual settings below for the sources and scalings.	0
	Transparent	The value selected by parameter 58.31 is sent as actual value 1. No scaling is applied (the 16-bit scaling is 1 = 1 unit).	1
	General	The value selected by parameter 58.31 is sent as actual value 1 with a 16-bit scaling of 100 = 1 unit (ie. integer and two decimals).	2
	Torque	<i>01.10 Motor torque</i> is sent as actual value 1. The scaling is defined by parameter 46.03.	3
	Speed	<i>01.01 Motor speed used</i> is sent as actual value 1. The scaling is defined by parameter 46.01.	4
	Frequency	<i>01.06 Output frequency</i> is sent as actual value 1. The scaling is defined by parameter 46.02.	5
	Position	Motor position is sent as actual value 1. See parameter <i>90.06 Motor position scaled</i> .	6
58.29	EFB act2 type	Selects the type/source and scaling of actual value 2 transmitted to the fieldbus network through the embedded fieldbus interface.	Torque
	Auto	Type/source and scaling follow the type of reference 2 selected by parameter 58.27. See the individual settings below for the sources and scalings.	0
	Transparent	The value selected by parameter 58.32 is sent as actual value 2. No scaling is applied (the 16-bit scaling is 1 = 1 unit).	1

No.	Name/Value	Description	Def/FbEq16
	General	The value selected by parameter 58.32 is sent as actual value 2 with a 16-bit scaling of 100 = 1 unit (ie. integer and two decimals).	2
	Torque	01.10 Motor torque is sent as actual value 2. The scaling is defined by parameter 46.03.	3
	Speed	01.01 Motor speed used is sent as actual value 2. The scaling is defined by parameter 46.01.	4
	Frequency	01.06 Output frequency is sent as actual value 2. The scaling is defined by parameter 46.02.	5
	Position	Motor position is sent as actual value 2. See parameter 90.06.	6
58.30	EFB status word transparent source	Selects the source of the status word when parameter 58.25 is set to Transparent.	Not selected
	Not selected	None.	0
	Other	Source selection	-
58.31	EFB act1 transparent source	Selects the source of actual value 1 when parameter 58.28 is set to Transparent or General.	Not selected
	Not selected	None.	0
	Other	Source selection	-
58.32	EFB act2 transparent source	Selects the source of actual value 1 when parameter 51.29 is set to Transparent or General.	Not selected
	Not selected	None.	0
	Other	Source selection	-
58.33	Addressing mode	Defines the mapping between parameters and holding registers in the 400101...465535 Modbus register range. Changes to this parameter take effect after the control unit is rebooted or the new settings validated by parameter 58.06.	Mode 0
	Mode 0	<u>16-bit values (groups 1...99, indexes 1...99):</u> Register address = 400000 + 100 × parameter group + parameter index. For example, parameter 22.80 would be mapped to register 400000 + 2200 + 80 = 402280. <u>32-bit values (groups 1...99, indexes 1...99):</u> Register address = 420000 + 200 × parameter group + 2 × parameter index. For example, parameter 22.80 would be mapped to register 420000 + 4400 + 160 = 424560.	0
	Mode 1	<u>16-bit values (groups 1...255, indexes 1...255):</u> Register address = 400000 + 256 × parameter group + parameter index. For example, parameter 22.80 would be mapped to register 400000 + 5632 + 80 = 405712.	1
	Mode 2	<u>32-bit values (groups 1...127, indexes 1...255):</u> Register address = 400000 + 512 × parameter group + 2 × parameter index. For example, parameter 22.80 would be mapped to register 400000 + 11264 + 160 = 411424.	2
58.34	Word order	Selects in which order 16-bit registers of 32-bit parameters are transferred. For each register, the first byte contains the high order byte and the second byte contains the low order byte. Changes to this parameter take effect after the control unit is rebooted or the new settings validated by parameter 58.06.	LO-HI
	HI-LO	The first register contains the high order word, the second contains the low order word.	0
	LO-HI	The first register contains the low order word, the second contains the high order word.	1

## 78 Parameters

No.	Name/Value	Description	Def/FbEq16														
58.36	EFB comm supervision force	<p>Activates fieldbus communication monitoring separately for each control location (see section <i>Local control vs. external control</i> in the ACS880 Firmware manual).</p> <p>The parameter is primarily intended for monitoring the communication with EFB when it is connected to the application program and not selected as a control source by drive parameters.</p>	0000b														
	<table border="1"> <thead> <tr> <th>Bit</th> <th>Name</th> <th>Value</th> </tr> </thead> <tbody> <tr> <td>0</td> <td>Ext 1</td> <td>1 = Communication monitoring active when Ext 1 is being used.</td> </tr> <tr> <td>1</td> <td>Ext 2</td> <td>1 = Communication monitoring active when Ext 2 is being used.</td> </tr> <tr> <td>2</td> <td>Local</td> <td>1 = Communication monitoring active when local control is being used.</td> </tr> <tr> <td>3...15</td> <td>Reserved</td> <td></td> </tr> </tbody> </table>	Bit	Name	Value	0	Ext 1	1 = Communication monitoring active when Ext 1 is being used.	1	Ext 2	1 = Communication monitoring active when Ext 2 is being used.	2	Local	1 = Communication monitoring active when local control is being used.	3...15	Reserved		
Bit	Name	Value															
0	Ext 1	1 = Communication monitoring active when Ext 1 is being used.															
1	Ext 2	1 = Communication monitoring active when Ext 2 is being used.															
2	Local	1 = Communication monitoring active when local control is being used.															
3...15	Reserved																
	0000b...0111b	EFB communication monitoring selection.	1 = 1														
58.101	Data I/O 1	<p>Defines the address in the drive which the Modbus master accesses when it reads from or writes to register address 400001.</p> <p>The master defines the type of the data (input or output). The value is transmitted in a Modbus frame consisting of two 16-bit words. If the value is 16-bit, it is transmitted in the LSW (least significant word). If the value is 32-bit, the subsequent parameter is also reserved for it and must be set to None.</p>	CW 16bit														
	None	None.	0														
	CW 16bit	Control Word (16 bits).	1														
	Ref1 16bit	Reference REF1 (16 bits).	2														
	Ref2 16bit	Reference REF2 (16 bits).	3														
	SW 16bit	Status Word (16 bits).	4														
	Act1 16bit	Actual value ACT1 (16 bits).	5														
	Act2 16bit	Actual value ACT2 (16 bits).	6														
	CW 32bit	Control Word (32 bits).	11														
	Ref1 32bit	Reference REF1 (32 bits).	12														
	Ref2 32bit	Reference REF2 (32 bits).	13														
	SW 32bit	Status Word (32 bits).	14														
	Act1 32bit	Actual value ACT1 (32 bits).	15														
	Act2 32bit	Actual value ACT2 (32 bits).	16														
	CW2 16bit	Control Word 2 (16 bits). When a 32-bit control word is used, this setting means the most-significant 16 bits.	21														
	SW2 16bit	Status Word 2 (16 bits). When a 32-bit control word is used, this setting means the most-significant 16 bits.	24														
	RO/DIO control word	Parameter <i>10.99 RO/DIO control word</i> .	31														
	AO1 data storage	Parameter <i>13.91 AO1 data storage</i> .	32														
	AO2 data storage	Parameter <i>13.92 AO2 data storage</i> .	33														
	Feedback data storage	Parameter <i>40.91 Feedback data storage</i> .	40														
	Setpoint data storage	Parameter <i>40.92 Setpoint data storage</i> .	41														
	Other	Source selection	-														
58.102	Data I/O 2	<p>Defines the address in the drive which the Modbus master accesses when it reads from or writes to register address 400002.</p> <p>For the selections, see parameter <i>58.101</i>.</p>	Ref1 16bit														

No.	Name/Value	Description	Def/FbEq16
58.103	Data I/O 3	Defines the address in the drive which the Modbus master accesses when it reads from or writes to register address 400003. For the selections, see parameter 58.101.	Ref2 16bit
58.104	Data I/O 4	Defines the address in the drive which the Modbus master accesses when it reads from or writes to register address 400004. For the selections, see parameter 58.101.	SW 16bit
58.105	Data I/O 5	Defines the address in the drive which the Modbus master accesses when it reads from or writes to register address 400005. For the selections, see parameter 58.101.	Act1 16bit
58.106	Data I/O 6	Defines the address in the drive which the Modbus master accesses when it reads from or writes to register address 400006. For the selections, see parameter 58.101.	Act2 16bit
58.107	Data I/O 7	Parameter selector for Modbus register address 400007. For the selections, see parameter 58.101.	None
...	...	...	...
58.124	Data I/O 24	Parameter selector for Modbus register address 400024. For the selections, see parameter 58.101.	None
<b>74 Trickle Current</b>		<p>For +N5350 firmware revision 2.00.3.3 or earlier, Trickle Current heating is a feature of the ACS880+N5350 CTDD that can be used by the customer to maintain a small amount of power going to the motor from the drive while the fan is not being used.</p> <p>For N5350 firmware revision later than 2.00.3.3 and later, a feature was added to help redistribute motor bearing grease called Rotation Trickle Current. <b>This feature does cause intermittent fan rotation on a periodic basis.</b> Default rotation is setup to occur once every hour for a period of 4 minutes at 10% rated motor speed. See parameter 74.04-74.06 for setup. Both the new and old method eliminate the need for motor space heaters which are normally specified when a motor is placed in a humid environment.</p> <p>See section 9 of the manual for more information.</p>	
74.01	Trickle Current Selection	Enables trickle current through four methods	DIO1
	Disable	Disable trickle current	0
	Enable	Enable trickle current whenever motor is not running	1
	DIO1	Enable trickle current using DIO1	2
	FBA	Enable trickle current through Fieldbus	3
	EFB	Enable trickle current through Embedded Fieldbus	4
74.02	Trickle Current Level	Determines the power in Watts to be delivered to the motor when in Trickle current mode. Find the equivalent heater power based on the motor frame size for this parameter.	100
	0...500 Watts	Power (values 0...500 are allowable)	1 = 1
	FL210	Baldor-Reliance IPM Cooling Tower Motor Frame FL210	75
	FL250	Baldor-Reliance IPM Cooling Tower Motor Frame FL250	75
	FL280	Baldor-Reliance IPM Cooling Tower Motor Frame FL280	100
	FL320	Baldor-Reliance IPM Cooling Tower Motor Frame FL320	125
	FL360	Baldor-Reliance IPM Cooling Tower Motor Frame FL360	150
	FL400	Baldor-Reliance IPM Cooling Tower Motor Frame FL400	175
	FL440	Baldor-Reliance IPM Cooling Tower Motor Frame FL440	225
	FL580	Baldor-Reliance IPM Cooling Tower Motor Frame FL580	400
74.03	Trickle Delay Time	This value is the delay time before trickle current starts. This delay is to ensure the motor has stopped prior to trickle current beginning.	1
	0...0 min.	Trickle Current Delay Time in minutes	1 = 1

## 80 Parameters



No.	Name/Value	Description	Def/FbEq16
74.04	Rotational Trickle Cycles/Hour	This represents the number of rotational cycles that will occur every hour during Rotational Trickle Current operation.	1
	1...5	Rotational Trickle Current Cycles / Hour.	1 = 1
74.05	Rotational Trickle Time	This value is the amount of time in minutes that rotation of the fan motor will occur every Rotational Trickle Cycle.	4
	3...10 min	Rotation Trickle Current rotation time per cycle (minutes).	1 = 1
74.06	Rotational Trickle speed	This is the Rotation Trickle speed as a percentage of motor nominal speed.	10%
	5...30%	Rotation Trickle speed %	1 = 1
<b>75 De-Ice Function</b>		De-ice configuration	
75.01	De-Ice Enable Selection	Enables De-Ice through four methods.	DIO2
	Disable	Disable De-Ice.	0
	DIO2	Enable De-Ice using DIO2.	1
	FBA	Enable De-Ice through Fieldbus.	2
	EFB	Enable De-Ice through Embedded Fieldbus.	3
75.02	De-Ice Speed	This value is the speed of the cooling tower fan while in De-Ice mode. Values are based on motor nominal speed.	30%
	0...100%	It is recommended that the minimum speed be 30% or higher.	
75.03	De-Ice Run Time	This is the De-Ice run time when the selection is enabled. The drive will run for this preset time and then stop. If time entered is zero (0), the De-Ice function will run continuously.	1
	0...1500 min.	De-Ice run time value	1 = 1
<b>76 CTDD Motor Control</b>		The ACS880+N5350 CTDD can be controlled using several different operating modes. These modes quickly setup the drive terminals to make it easy for the user to plan the design. Select one of 4 operating modes. Autophasing is an automatic measurement used to determine the angular position of magnetic flux of the permanent magnet motor.	30%
76.01	Autophasing Current	Autophasing current is the % DC current level the drive puts out to line up the rotor.	50%
	0...150 %	Autophasing current range	1 = 1
76.02	Autophasing Time	Autophasing time is the time it takes for the rotor to settle out before rotation is started. With high-inertia fans it could take 100 seconds for this to occur.	15
	0...100 s	The Autophasing time is how long the rotor can take to settle out before rotation is started. Because of the high inertia of the large fans, it could take 100 seconds to settle out.	1 = 1
76.03	Operating Mode	Default: 1 (2-Wire) Range: 0 - 4	1 (2-Wire)
	2-Wire	Enables 2 wire control via digital I/O	1
	3-Wire	Enables 3-wire control via digital I/O	2
	PID	Enables 2-wire control via digital I/O and speed or PID closed loop control	3
	FBA	Enable cooling tower operation via Fieldbus control	4
76.04	CT Minimum Speed	Sets the minimum forward operating speed of the CTDD motor.	0
	0...1000 rpm	1 = 1 rpm	1 = 1
<b>90 Feedback selection</b>		Motor and load feedback configuration. See also sections <i>Encoder support</i> and <i>Position counter</i> , and the diagram in the <i>ACS880 Firmware manual</i> .	
90.42	Motor speed filter time	Defines a filter time for motor speed feedback used for speed control ( <i>90.01 Motor speed for control</i> ).	30



No.	Name/Value	Description	Def/FbEq16																					
	0 ... 10000 ms	Motor speed filter time.	1 = 1 ms																					
No.	Name/Value	Description	Def/FbEq16																					
<b>96 System</b>		Language selection; access levels; macro selection; parameter save and restore; control unit reboot; user parameter sets; unit selection; data logger triggering; parameter checksum calculation; user lock.																						
96.02	Pass code	Pass codes can be entered into this parameter to activate further access levels (see parameter 96.03) or to configure the user lock. Entering "358" toggles the parameter lock, which prevents the changing of all other parameters through the control panel or the Drive composer PC Tool.	0																					
	0...99999999	Pass code.	-																					
		User Level Access	14																					
		Fieldbus Access	13																					
		Expert Commissioner Access	12																					
96.03	Access levels active	Shows which access levels have been activated by pass codes entered into parameter 96.02. This parameter is read-only.	0001h																					
		<table border="1"> <thead> <tr> <th>Bit</th> <th>Name</th> </tr> </thead> <tbody> <tr> <td>0</td> <td>End user</td> </tr> <tr> <td>11</td> <td>Expert commissioner</td> </tr> <tr> <td>12</td> <td>Fieldbus</td> </tr> <tr> <td>13</td> <td>CTDD User</td> </tr> </tbody> </table>	Bit	Name	0	End user	11	Expert commissioner	12	Fieldbus	13	CTDD User												
Bit	Name																							
0	End user																							
11	Expert commissioner																							
12	Fieldbus																							
13	CTDD User																							
	0000h...FFFFh	Active access levels.	-																					
96.04	Macro select	Selects the application macro. See chapter <i>Application macros</i> in the <i>ACS880 Firmware manual</i> for more information. After a selection is made, the parameter reverts automatically to Done. <b>NOTE:</b> This parameter cannot be changed while the drive is running.	Done																					
	Done	Macro selection complete; normal operation.	0																					
	CTDD	Cooling Tower macro.	2																					
96.05	Macro active	Shows which application macro is currently selected. See chapter <i>Application macros</i> in the <i>ACS880 Firmware manual</i> for more information. To change the macro, use parameter 96.04.	2																					
	CTDD	Cooling Tower macro	2																					
96.16	Unit selection	Selects the unit of parameters indicating power, temperature and torque.	0001 0001b																					
		<table border="1"> <thead> <tr> <th>Bit</th> <th>Name</th> <th>Information</th> </tr> </thead> <tbody> <tr> <td>0</td> <td>Power unit</td> <td>0 = kW 1 = hp</td> </tr> <tr> <td>1</td> <td>Reserved</td> <td></td> </tr> <tr> <td>2</td> <td>Temperature unit</td> <td>0 = C (°C) 1 = F (°F)</td> </tr> <tr> <td>3</td> <td>Reserved</td> <td></td> </tr> <tr> <td>4</td> <td>Torque unit</td> <td>0 = Nm (N·m) 1 = lbft (lbf·ft)</td> </tr> <tr> <td>5...15</td> <td>Reserved</td> <td></td> </tr> </tbody> </table>	Bit	Name	Information	0	Power unit	0 = kW 1 = hp	1	Reserved		2	Temperature unit	0 = C (°C) 1 = F (°F)	3	Reserved		4	Torque unit	0 = Nm (N·m) 1 = lbft (lbf·ft)	5...15	Reserved		
Bit	Name	Information																						
0	Power unit	0 = kW 1 = hp																						
1	Reserved																							
2	Temperature unit	0 = C (°C) 1 = F (°F)																						
3	Reserved																							
4	Torque unit	0 = Nm (N·m) 1 = lbft (lbf·ft)																						
5...15	Reserved																							
	0000 0000b ... 0001 0101b	Unit selection word.	1 = 1																					

## 82 Parameters

No.	Name/Value	Description	Def/FbEq16
<b>99 Motor data</b>		Motor configuration settings.	
99.03	Motor type	Selects the motor type. <b>NOTE:</b> This parameter cannot be changed while the drive is running.	Permanent Magnet motor (95.21 b1); Permanent magnet motor (95.21 b2)
	ACS880 Training Demo	This selection is used when loading firmware in the standard ACS880 Demo Case only.	0
	Permanent magnet motor	Permanent magnet motor. Three-phase AC synchronous motor with permanent magnet rotor and sinusoidal BackEMF voltage.	1
99.07	BACK EMF voltage	Defines the motor BACK EMF voltage. This setting must match the value on the motor auxiliary rating plate. Notes: <ul style="list-style-type: none"> <li>• With permanent magnet motors, the nominal voltage is the BackEMF voltage at nominal speed of the motor.</li> <li>• The stress on the motor insulation is always dependent on the drive supply voltage. This also applies to the case where the motor voltage rating is lower than that of the drive and the supply.</li> <li>• This parameter cannot be changed while the drive is running.</li> </ul>	0.0 V
	0.0 ... 800.0 V	Nominal voltage of the motor. The allowable range is $1/6 \dots 2 \times U_N$ (nominal voltage) of the drive. $U_N$ equals the upper bound of the supply voltage range selected by parameter 95.01 Supply voltage.	10 = 1 V
99.08	Motor nominal frequency	Defines the nominal motor frequency. This setting must match the value on the rating plate of the motor. <b>NOTE:</b> This parameter cannot be changed while the drive is running.	0.00 Hz
	0.00 ... 1000.00 Hz	Nominal frequency of the motor.	10 = 1 Hz
99.09	Motor nominal speed	Defines the nominal motor speed. The setting must match the value on the rating plate of the motor. <b>NOTE:</b> This parameter cannot be changed while the drive is running.	0 rpm
	0 ... 1000 rpm	Nominal speed of the motor.	1 = 1 rpm

No.	Name/Value	Description	Def/FbEq16
99.13	ID run requested	<p>Selects the type of the motor identification routine (ID run) performed at the next start of the drive. During the ID run, the drive will identify the characteristics of the motor for optimum motor control.</p> <p>If no ID run has been performed yet (or if default parameter values have been restored using parameter <i>96.06 Parameter restore</i>), this parameter is automatically set to <i>Standstill</i>, signifying that an ID run must be performed.</p> <p>After the ID run, the drive stops and this parameter is automatically set to <i>None</i>.</p> <p>Notes:</p> <ul style="list-style-type: none"> <li>• For the <i>Advanced</i> ID run, the machinery must always be de-coupled from the motor.</li> <li>• Before activating the ID run, configure motor temperature measurement (if used) in parameter group <i>35 Motor thermal protection</i>, and in parameter <i>97.15</i>.</li> <li>• If a sine filter is installed, set the appropriate bit in parameter <i>95.15 Special HW settings</i> before activating the ID run. With a non-ABB (custom) filter, set also <i>99.18</i> and <i>99.19</i>.</li> <li>• With scalar control mode (<i>99.04 Motor control mode = Scalar</i>), the ID run is not requested automatically. However, an ID run can be performed for more accurate torque estimation.</li> <li>• Once the ID run is activated, it can be canceled by stopping the drive.</li> <li>• The ID run must be performed every time any of the motor parameters (<i>99.04, 99.06...99.12</i>) have been changed.</li> <li>• Ensure that the Safe torque off and emergency stop circuits (if any) are closed during the ID run.</li> <li>• Mechanical brake (if present) is not opened by the logic for the ID run.</li> <li>• This parameter cannot be changed while the drive is running.</li> </ul>	None; Standstill ( <i>95.21 b1/b2</i> )
	None	No motor ID run is requested. This mode can be selected only if the ID run (Normal, Reduced, Standstill, Advanced, Advanced Standstill) has already been performed once.	0
	Normal	<p>Normal ID run. Guarantees good control accuracy for all cases. The ID run takes about 90 seconds. This mode should be selected whenever it is possible.</p> <p>Notes:</p> <p>If the load torque will be higher than 20% of motor nominal torque, or if the machinery is not able to withstand the nominal torque transient during the ID run, then the driven machinery must be de-coupled from the motor during a Normal ID run.</p> <p>Check the direction of rotation of the motor before starting the ID run. During the run, the motor will rotate in the forward direction.</p> <p> <b>WARNING!</b> The motor will run at up to approximately 50...100% of the nominal speed during the ID run. ENSURE THAT IT IS SAFE TO RUN THE MOTOR BEFORE PERFORMING THE ID RUN!</p>	1
	Reduced	<p>Reduced ID run. This mode should be selected instead of the Normal or Advanced ID Run if mechanical losses are higher than 20% (i.e. the motor cannot be de-coupled from the driven equipment), or if flux reduction is not allowed while the motor is running (i.e. in case of a motor with an integrated brake supplied from the motor terminals).</p> <p>With this ID run mode, the resultant motor control in the field weakening area or at high torques is not necessarily as accurate as motor control following a Normal ID run. Reduced ID run is completed faster than the Normal ID Run (&lt; 90 seconds).</p> <p><b>NOTE:</b> Check the direction of rotation of the motor before starting the ID run. During the run, the motor will rotate in the forward direction.</p> <p> <b>WARNING!</b> The motor will run at up to approximately 50...100% of the nominal speed during the ID run. ENSURE THAT IT IS SAFE TO RUN THE MOTOR BEFORE PERFORMING THE ID RUN!</p>	2

## 84 Parameters

No.	Name/Value	Description	Def/FbEq16
	Standstill	<p>Standstill ID run. The motor is injected with DC current. With an AC induction (asynchronous) motor, the motor shaft is not rotated. With a permanent magnet motor or synchronous reluctance motor, the shaft can rotate up to half a revolution.</p> <p><b>NOTE:</b> A standstill ID run should be selected only if the Normal, Reduced or Advanced ID run is not possible due to the restrictions caused by the connected mechanics (eg. with lift or crane applications). See also selection Advanced Standstill.</p>	3
	Autophasing	<p>The autophasing routine determines the start angle of a permanent magnet or synchronous reluctance motor (see page 59). Autophasing does not update the other motor model values.</p> <p>Autophasing is automatically performed as part of the Normal, Reduced, Standstill, Advanced or Advanced Standstill ID runs. Using this setting, it is possible to perform autophasing alone. This is useful after changes in the feedback configuration, such as the replacement or addition of an absolute encoder, resolver, or pulse encoder with commutation signals.</p> <p>Notes: This setting can only be used after a Normal, Reduced, Standstill, Advanced or Advanced Standstill ID run has already been performed. Depending on the selected autophasing mode, the shaft can rotate during autophasing. See parameter 21.13.</p>	4
	Current measurement calibration	<p>Requests current measurement calibration, ie. identification of current measurement offset and gain errors. The calibration will be performed at next start.</p>	5
	Advanced	<p>Advanced ID run. Guarantees the best possible control accuracy. The ID run can take a couple of minutes. This mode should be selected when top performance is needed across the whole operating area.</p> <p><b>NOTE:</b> The driven machinery must be de-coupled from the motor because of high torque and speed transients that are applied.</p> <p> <b>WARNING!</b> The motor will run at up to approximately 50...100% of the nominal speed during the ID run. Several accelerations and decelerations are done. ENSURE THAT IT IS SAFE TO RUN THE MOTOR BEFORE PERFORMING THE ID RUN!</p>	6
	Advanced Standstill	<p>Advanced Standstill ID run. This selection is recommended with AC induction motors up to 75 kW instead of the Standstill ID run if the exact nominal ratings of the motor are not known, or the control performance of the motor is not satisfactory after a Standstill ID run.</p> <p><b>NOTE:</b> The time it takes for the Advanced Standstill ID run to complete varies according to motor size. With a small motor, the ID run typically completes within 5 minutes; with a large motor, the ID run may take up to an hour.</p>	7

# 12

## Fault Tracing

---

The ACS880+N5350 CTDD will report events that are abnormal during operation as a warning or fault. The codes and names of active warnings/faults are displayed on the control panel of the drive. Only the codes of warnings/faults are available over fieldbus.

This chapter is a subset of information listed in the *ACS880 Firmware manual*. Please refer to this manual for more information.

### Warnings and Faults

Warnings do not need to be reset; they stop showing when the cause of the warning ceases.

Faults cause the drive to trip, and motor to stop. After the cause of a fault has been removed, the fault can be reset from a selectable source (see parameter 31.11) such as the control panel, Drive Composer PC Tool, the digital inputs of the drive, or fieldbus. After the fault is reset, the drive can be restarted.

### Pure Events

In addition to warnings and faults, there are pure events that are only recorded in the event log of the drive. The codes of these events are included in the Warning messages table.

### Editable Messages

For some warnings and faults, the message text can be edited and instructions and contact information added. To edit these messages, choose Menu - Settings - Edit texts on the control panel. For more information consult the *ACS880 Firmware manual*.

### Warning/Fault History

#### Event Log

The drive has two event logs. One log contains faults and fault resets; the other contains warnings, pure events, and clearing entries. Each log contains the 64 most recent events with a time stamp and other information.

The logs can be accessed separately from the main Menu on the control panel. The logs are displayed as a single list when viewed using the Drive composer PC tool see *Drive composer start-up and maintenance PC tool user's manual*.

The logs can be cleared using parameter 96.51 Clear fault and event logger. Refer to the *ACS880 Firmware manual* for more information.

All indications are stored in the event log with a time stamp and other information. The event log can be accessed from the main Menu on the control panel. It can also be accessed (and reset) using the Drive composer PC tool. In Drive composer, some faults are presented with additional data recorded prior to the fault.

---

## Auxiliary Codes

Some events generate an auxiliary code that often helps in pinpointing the problem. On the control panel, the auxiliary code is stored as part of the details of the event; in the Drive composer PC tool, the auxiliary code is shown in the event listing.

## Parameters that Contain Warning/Fault Information

The drive is able to store a list of the active faults actually causing the drive to trip at the present time. The faults are displayed in parameter group 04 Warnings and faults. The parameter group also displays a list of faults and warnings that have previously occurred.

## Warning Messages

Note: This list contains events that only appear in the Event Log. For a full list refer to the [ACS880 Firmware manual](#).

Table 12-1 Warning Messages (Alphabetical by Keypad Text)

Warning	Fault #	Cause	What to do
Overcurrent	A2B1	Output current has exceeded internal fault limit.	<p>Check motor load.</p> <p>Check acceleration times in parameter <a href="#">Group 23 Speed reference ramp (speed control)</a>, <a href="#">26 Torque reference chain</a> (torque control) or <a href="#">28 Frequency reference chain</a> (frequency control). Also check parameters <a href="#">46.01</a>, <a href="#">46.02</a>, and <a href="#">46.03</a>.</p> <p>Check motor and motor cable (including phasing and delta/star connection).</p> <p>Check there are no contactors opening and closing in motor cable.</p> <p>Check that the start-up data in parameter <a href="#">Group 99 Motor data</a> corresponds to the motor rating plate.</p> <p>Check that there are no power factor correction capacitors or surge absorbers in motor cable.</p> <p>Check encoder cable (including phasing).</p>
DC voltage difference	A3C1	Difference in DC voltages between parallel-connected inverter modules.	Contact your local ABB representative.
IGBT overtemperature	A4A1	Estimated drive IGBT temperature is excessive.	<p>Check ambient conditions.</p> <p>Check air flow and fan operation.</p> <p>Check heatsink fins for dust pick-up.</p> <p>Check motor power against drive power.</p>
No motor data	A6A5	Parameters in group 99 have not been set.	Check that all required parameters in group 99 have been set.
Input phase loss Programmable fault: 31.21 Supply phase loss	3130	Intermediate circuit DC voltage is oscillating due to missing input power line phase or blown fuse.	<p>Check input power line fuses.</p> <p>Check for loose power cable connections.</p> <p>Check for input power supply imbalance.</p>
Charge relay lost	3180	No acknowledgment received from charge relay.	Contact your local ABB representative.
Cross connection Programmable fault: 31.23 Cross connection	3181	Incorrect input power and motor cable connection (i.e. input power cable is connected to drive motor connection).	Check input power connections.

Warning	Fault #	Cause	What to do
DC link overvoltage	3210	Excessive intermediate circuit DC voltage.	<p>Check that overvoltage control is on (parameter 30.30).                      Check that the supply voltage matches the nominal input voltage of the drive.                      Check the supply line for static or transient overvoltage.                      Check brake chopper and resistor (if present).                      Check deceleration time.                      Use coast-to-stop function (if applicable).                      Retrofit drive with brake chopper and brake resistor.                      Check parameter 90.42 is programmed to 30m seconds.                      Check the speed loop tuning parameters in Group 25 Speed control, if the settings are too dynamic this could cause the drive to fault.                      The drive can trip on this fault if the Autophasing time and level is not high enough for the application, if the Autophasing levels are programmed to low the fan will not come to a full stop before the motor starts and this will cause the drive to fault.</p>
DC link undervoltage	3220	Intermediate circuit DC voltage is not sufficient because of a missing supply phase, blown fuse or fault in the rectifier bridge.	Check supply cabling, fuses and switchgear.
Standby timeout	3280	Automatic restart failed (see section Automatic restart).	Check the condition of the supply (voltage, cabling, fuses, switchgear).
DC voltage difference	3291	Difference in DC voltages between parallel-connected inverter modules.	Contact your local ABB representative.
Output phase loss Programmable fault: 31.19 Motor phase loss	3381	Motor circuit fault due to missing motor connection (all three phases are not connected).	Connect motor cable.
Autophasing	3385	Autophasing routine (see section Autophasing) has failed.	<p>Try other autophasing modes (see parameter 21.13) if possible.                      Check that the motor ID run has been successfully completed.                      Clear parameter 98.15 Position offset user.                      Check that the encoder is not slipping on the motor shaft.                      Check that the motor is not already turning when the autophasing routine starts.                      Check the setting of parameter 99.03.</p>
Internal SW error	6180	Internal error.	<p>Contact your local ABB representative.                      Quote the auxiliary code (check the event details in the event log).</p>
Line side converter faulted	7358	The supply unit has tripped on a fault.	If using a control panel or the Drive composer tool, connect to the supply unit to read the fault code. Refer to the firmware manual of the supply unit for instructions related to the code.
Vibration Switch Fault	9081	DI6 is open which triggers a vibration switch fault.	Cooling tower should be checked for cause of excessive vibration as indicated on DI6.

# 13

## Modbus RTU Setup

### ACS880 CTDD

#### Modbus RTU Serial Communication Setup using built-in D2D (drive to drive) port

This document will guide you through the process of setting up the ACS880 CTDD for monitoring and control over Modbus RTU using the following data in and out:

Figure 13-1



### Setting fieldbus Parameters

This guide assumes that the two startup assistants have been run. Note that fieldbus must have already been selected. (Refer to Chapter 10) Follow the remaining steps to configure Modbus RTU.

1. Once basic drive setup has been completed, set the following parameters:

96.02 Pass Code = 13 Fieldbus. This opens parameter group 50 - 58.	
Group 58 Embedded fieldbus	
58.01 Protocol Enable = ModbusRTU	
58.03 Node Address = 1	This is the drive's node address on the Modbus RTU network
58.25 Control Profile = Transparent	
58.26 EFB Ref1 Type = Transparent	Speed scaling is 1 unit = 1 rpm
58.28 EFB Act 1 Type = Transparent	
58.29 EFB Act2 Type = Transparent	Torque scaling is 1 unit = 1%
58.30 EFB status word transparent = 6.11[16]	Status Word
58.31 EFB Act1 transparent source = 1.1[16]	Actual Speed
58.32 EFB Act2 transparent source = 1.10[16]	Motor Torque
58.34 Word order = HI-LO	
58.110 Data I/O 10 = 1.7[16]	Motor Current



58.111 Data I/O 11 = 1.11[16]	DC Bus Voltage
58.112 Data I/O 12 = 1.14[16]	Motor Power

- Set parameter 58.06 to Refresh, this applies the fieldbus settings.

Communication should now be established and that should complete the fieldbus setup on the drive.

### Simulating a Modbus RTU Master

The table below shows the default Modbus holding register addresses for a drive data. This profile provides a converted 16-bit access to the data.

Register address	Register data (16-bit words)
400001	Control word. See section Control Word. The selection can be changed using parameter 58.101
400002	Reference 1 (REF1). The selection can be changed using parameter 58.102
400003	Reference 2 (REF2). The selection can be changed using parameter 58.103
400004	Status Word (SW). See section Status Word. The selection can be changed using parameter 58.104
400005	Actual value 1 (ACT1). The selection can be changed using parameter 58.105
400006	Actual value 2 (ACT2). The selection can be changed using parameter 58.106
400007...400024	Data in/out 7...24. Selected by parameters 58.107 ...58.124

- Connect laptop to the "XD2D" connector of the drive's D2D port. An RS-232 to RS-485 converter will likely be required.
- Pay attention to RS-485 signal polarity. Generally "A" is (-) and "B" is (+). If communication just doesn't work, try swapping these lines. Terminate the drive end of the bus by turning ON switch J3.

### Simulating PLC using ModbusPoll SW

As an option, you can simulate a Modbus RTU master using the ModbusPoll Software. Some familiarity with this software is assumed.

- On your PC configure the Modbus Poll Read/Write definitions as shown below.

## 90 Modbus RTU Setup

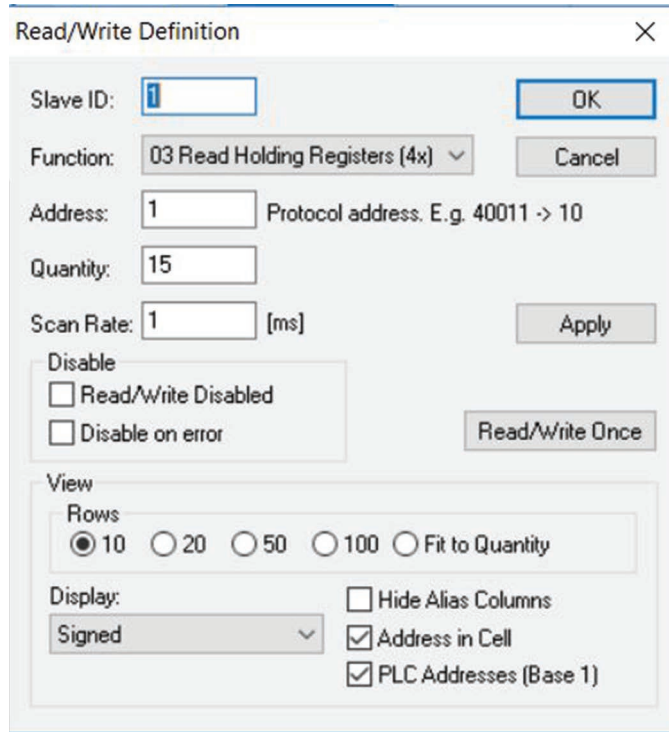

The "Read/Write Definition" dialog box is used to configure Modbus communication parameters. It includes the following fields and options:

- Slave ID:** Input field with the value "1".
- Function:** Dropdown menu set to "03 Read Holding Registers (4x)".
- Address:** Input field with the value "1". A note indicates "Protocol address. E.g. 40011 -> 10".
- Quantity:** Input field with the value "15".
- Scan Rate:** Input field with the value "1" and the unit "[ms]".
- Buttons:** "OK", "Cancel", "Apply", and "Read/Write Once".
- Disable section:** Contains two checkboxes: "Read/Write Disabled" and "Disable on error", both of which are currently unchecked.
- View section:** Includes a "Rows" section with radio buttons for "10" (selected), "20", "50", "100", and "Fit to Quantity". Below this is a "Display:" section with a dropdown menu set to "Signed" and three checkboxes: "Hide Alias Columns" (unchecked), "Address in Cell" (checked), and "PLC Addresses (Base 1)" (checked).

2. Then click "Connection" from the top menu, and select "Connect".  
The window below will appear.

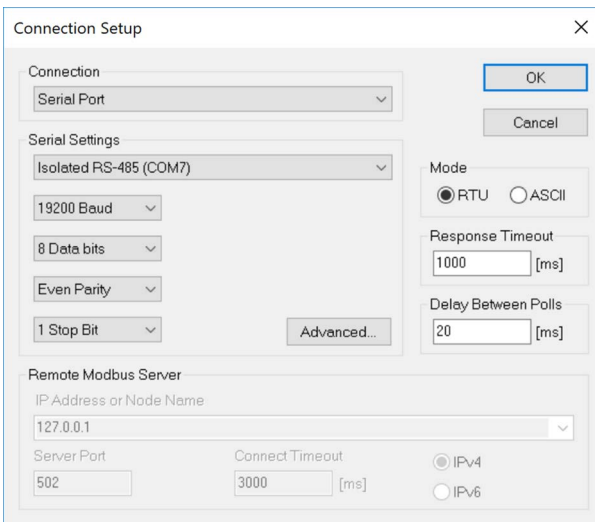

The "Connection Setup" dialog box is used to configure the connection parameters. It includes the following fields and options:

- Connection:** Dropdown menu set to "Serial Port".
- Serial Settings:** Includes a dropdown for "Isolated RS-485 (COM7)", and input fields for "19200 Baud", "8 Data bits", "Even Parity", and "1 Stop Bit". An "Advanced..." button is also present.
- Mode:** Radio buttons for "RTU" (selected) and "ASCII".
- Response Timeout:** Input field with the value "1000" and the unit "[ms]".
- Delay Between Polls:** Input field with the value "20" and the unit "[ms]".
- Remote Modbus Server:** Includes a dropdown for "IP Address or Node Name" with the value "127.0.0.1", an input field for "Server Port" with the value "502", and an input field for "Connect Timeout" with the value "3000" and the unit "[ms]".
- IP Version:** Radio buttons for "IPv4" (selected) and "IPv6".
- Buttons:** "OK" and "Cancel".

3. Click OK.

You should now see the packet counters at the top of the windows begin to increment. This indicates that data is being sent to, and received from, the drive.

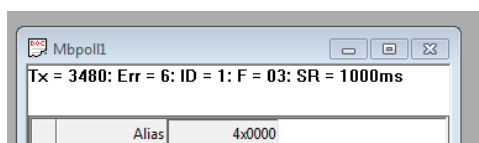

You should also be receiving a “live” bus voltage value. Looking at bus voltage (a value that constantly changes) is a good way to verify working communication.

4. You can now simulate a PLC with the screen below.

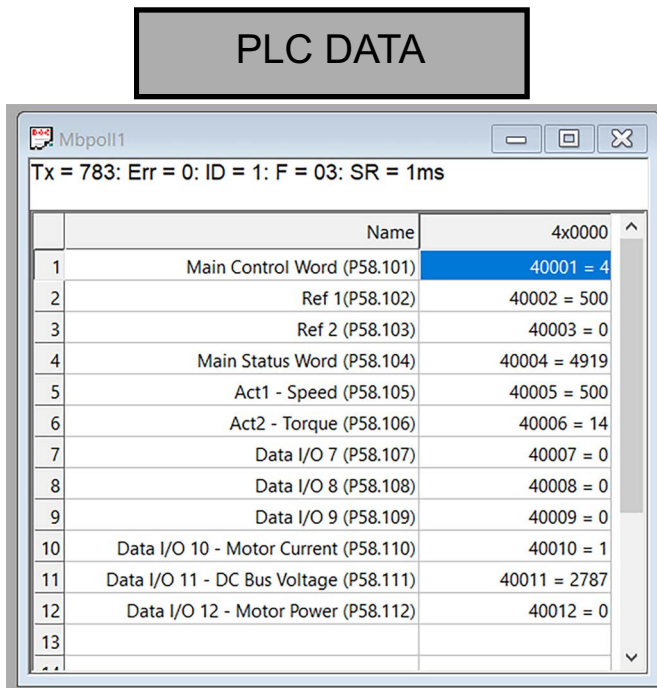

### Controlling the drive over fieldbus:

If the drive will ONLY be controlled over fieldbus, then DI2 must be jumpered to +24V.

#### Control Word bit structure

These bits control the function of the drive:

Bit	Name	Value	Description
0	Trickle Current Heating	1	Trickle Current Heating Enabled
		0	Trickle Current Heating Disabled
1	De-Ice Mode	1	De-Ice Mode Enabled
		0	De-Ice Disabled
2	Start Forward	1	Operation enabled with Forward run command
		0	Stopped
3	Reset	1	Fault reset if an active fault exists
		0	Continue normal operation
4-15	Reserved for Future Use		

Turning a bit ON will cause that function to start. Only one function should be ON at a time.

As an example, lets start the drive and run at 100 rpm. Follow the steps below:

1. Write a value of 100 to REF1 for the speed reference. (100 rpm)
2. Set CW bit 2 = 1 by writing a decimal value of 4 to the CW. (drive should start)

## 92 Modbus RTU Setup

The screens in Modbus Poll should look like these.

The screenshot shows a window titled 'Mbpoll1' with a status bar at the top displaying 'Tx = 783: Err = 0: ID = 1: F = 03: SR = 1ms'. Below the status bar is a table with the following data:

	Name	Value
1	Main Control Word (P58.101)	40001 = 4
2	Ref 1 (P58.102)	40002 = 500
3	Ref 2 (P58.103)	40003 = 0
4	Main Status Word (P58.104)	40004 = 4919
5	Act1 - Speed (P58.105)	40005 = 500
6	Act2 - Torque (P58.106)	40006 = 14
7	Data I/O 7 (P58.107)	40007 = 0
8	Data I/O 8 (P58.108)	40008 = 0
9	Data I/O 9 (P58.109)	40009 = 0
10	Data I/O 10 - Motor Current (P58.110)	40010 = 1
11	Data I/O 11 - DC Bus Voltage (P58.111)	40011 = 2787
12	Data I/O 12 - Motor Power (P58.112)	40012 = 0
13		

Refer to CTDD status in the Main Status Word (SW) in par 6.11:

Bit	Name	Value	Description
0	Ready to switch ON	1	Ready to switch ON
		0	Not ready to switch ON
1	Ready run	1	Ready to operate
		0	OFF1 active
2	Ready ref	1	Operation enabled
		0	Operation inhibited
3	Tripped	1	Fault
		0	No Fault
4	OFF2 inactive	1	OFF2 inactive
		0	OFF2 active
5	OFF3 inactive	1	OFF3 inactive
		0	OFF3 active
6	Switch-on inhibited	1	Switch-on inhibited
		0	--
7	Warning	1	Warning active
		0	No warning active
8	At setpoint	1	Operating - Actual value equals reference = is within tolerance limits (see parameters 46.21 - 46.23)
		0	Actual value differs from reference = is outside tolerance limits
9	Remote	1	Drive control location: Remote (EXT1 or EXT2)
		0	Drive control location: Local
10	Trickle Current Active	1	Trickle Current ON
		0	Trickle Current OFF
11	De-Ice Mode Active	1	De-Ice Mode ON
		0	De-Ice Mode OFF
12	CTDD Run	1	CTDD Running
		0	CTDD Not Running
13	CTDD HOLD	1	CTDD Autophase ON
		0	CTDD Autophase OFF
14	Trickle Rotate Active	1	Trickle Current Rotation Enabled
		0	Trickle current Rotation Disabled
15	Reserved		

**Troubleshooting:**

- Verify the CW being received by the drive by looking at par 6.05 EFB Transparent Control Word. This will be the raw value being sent by the PLC.
  - Verify the current speed reference being used by the drive by looking at par 47.01 DataStorage 1. This parameter will contain the active reference whether it comes from Embedded Fieldbus or an analog input.
-

# Ethernet/IP Setup

## ACS880 CTDD

### Ethernet/IP Setup

This document will guide you through the process of setting up the ACS880 CTDD for monitoring and control over Ethernet/IP using the following data in and out:

Figure 14-1



### Setting fieldbus Parameters

This guide assumes that the two startup assistants have been run. Note that fieldbus must have already been selected. (Refer to [Chapter 10](#)) Follow the remaining steps to configure Ethernet IP.

1. Once this basic drive setup has been completed, set the following parameters:

96.02 Pass Code = 13 Fieldbus. This opens parameter group 50 - 58.	
<i>Group 50 Fieldbus adapter (FBA)</i>	
50.01 FBA A Enable = Option Slot 1	This is the top option slot on the drive. Adapter can go in any slot
50.02 FBA A Comm Loss Function = Warning	This setting determines what the drive does when comms are lost
50.03 FBA A Comm Loss Timeout = 3sec	This time is added to the time in 51.20 before issuing a fault/warning
50.04 FBA A ref1 Type = Speed	
50.08 FBA A Act 2 type = Torque	
<i>Group 51 FBA A settings (Ethernet Adapter Setup)</i>	
51.01 FBA A Type = EtherNet	
51.02 Protocol/Profile = EIP T16 (102)	
51.03 Comm Rate = Auto	Automatically adjusts to 10 or 100Mbit/s network speed
51.04 IP Configuration = STATIC	
51.05 IP Address	ex. 192

51.06 IP Address	ex. 168
51.07 IP Address	ex. 3
51.08 IP Address	ex. 88
51.09 Subnet CIDR = 24	Shorthand for 255.255.255.0
51.10 GW Address	Leave at default (zero) if not used
51.11 GW Address	Leave at default (zero) if not used
51.12 GW Address	Leave at default (zero) if not used
51.13 GW Address	Leave at default (zero) if not used
Group 52 FBA A data in (PLC Input Data)	
(Note: that first three words back to PLC are pre-defined or already mapped for you.)	
Main Status Word (MSW)	See status word bit description below
Actual Value 1	Speed (1=1rpm)
Actual Value 2	Torque (% of motor nominal x 100)
52.01 FBA A Data In1 = Parameter 1.07[16]	Motor Current (1=1Amp)
52.02 FBA A Data In2 = Parameter 1.11[16]	DC Bus Voltage x 10
52.03 FBA A Data In3 = Parameter 1.14[16]	Actual motor power in HP x 10
52.04 FBA A Data In4...	These additional data words could be used to read other parameters from the drive.
52.10 FBA A Data In10	These additional data words could be used to read other parameters from the drive.
(Note: the first three words sent to the drive are pre-defined or already mapped for you.)	
Main Control Word (MCW)	See control word bit description below.
Speed Reference 1	Scaling is 1=1rpm
Reference 2	Not used in ACS880 CTDD
53.01 FBA A Data Out1 = Parameter 23.14[16]	Accel Time 2 (optional) These additional data words could be used to write to other parameters within the drive. For example, writing a value of 300 here would set par 23.12 Accel Time 1 to 30 seconds.
53.02 FBA A Data Out2...	These additional parameters can be mapped here for cyclic updating.
53.10 FBA A Data Out10	These additional parameters can be mapped here for cyclic updating.

2. Set parameter 51.27 to Refresh. This reboots the fieldbus card so changes can take effect.

Bit	Name	Value	Description
0	Trickle Current Heating	1	Trickle Current Heating Enabled
		0	Trickle Current Heating Disabled
1	De-Ice Mode	1	De-Ice Mode Enabled
		0	De-Ice Mode Disabled
2	Start Forward	1	Operation enabled with Forward run command
		0	Stopped
3	Reset	1	Fault reset if an active fault exists
		0	Continue normal operation
4-15	Reserved for Future Use		

The Main Status Word (MSW) in the ACS880+N5350 CTDD is different than that of a Standard ACS880 drive. In addition to the standard bits 0-9, the ACS880+N5350 CTDD incorporates bits 10-14 for CTDD status.

Bit	Name	Value	Description
0	Ready to switch ON	1	Ready to switch ON
		0	Not ready to switch ON
1	Ready run	1	Ready to operate
		0	OFF1 active
2	Ready ref	1	Operation enabled
		0	Operation inhibited

## 96 Ethernet/IP Setup

3	Tripped	1	Fault
		0	No Fault
4	OFF2 inactive	1	OFF2 inactive
		0	OFF2 active
5	OFF3 inactive	1	OFF3 inactive
		0	OFF3 active
6	Switch-on inhibited	1	Switch-on inhibited
		0	--
7	Warning	1	Warning active
		0	No warning active
8	At setpoint	1	Operating - Actual value equals reference = is within tolerance limits (see parameters 46.21 - 46.23)
		0	Actual value differs from reference = is outside tolerance limits
9	Remote	1	Drive control location: Remote (EXT1 or EXT2)
		0	Drive control location: Local
10	Trickle Current Active	1	Trickle Current ON
		0	Trickle Current OFF
11	De-Ice Mode Active	1	De-Ice Mode ON
		0	De-Ice Mode OFF
12	CTDD Run	1	CTDD Running
		0	CTDD Not Running
13	CTDD HOLD	1	CTDD Autophase ON
		0	CTDD Autophase OFF
14	Trickle Rotate Active	1	Trickle Current Rotation Enabled
		0	Trickle current Rotation Disabled
15	Reserved		

### Add Drive to RA PLC Project

Follow the steps below to add the ABB ACS880+N5350 CTDD to the Project.

1. Open Studio 5000 Logix Designer® or RSLogix® 5000 and open a new project.
2. Right click on the Ethernet module within the Controller Organizer window.

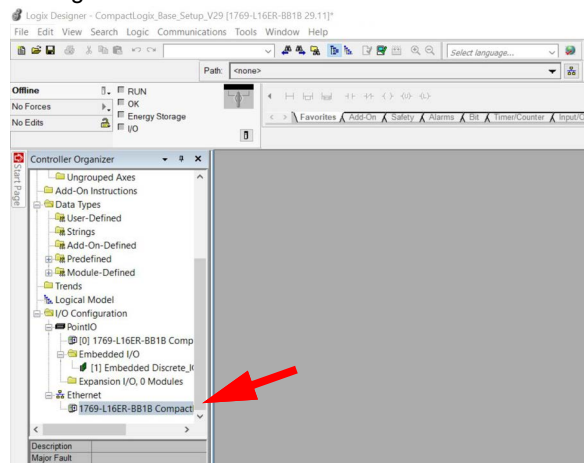



3. Click on New Module.

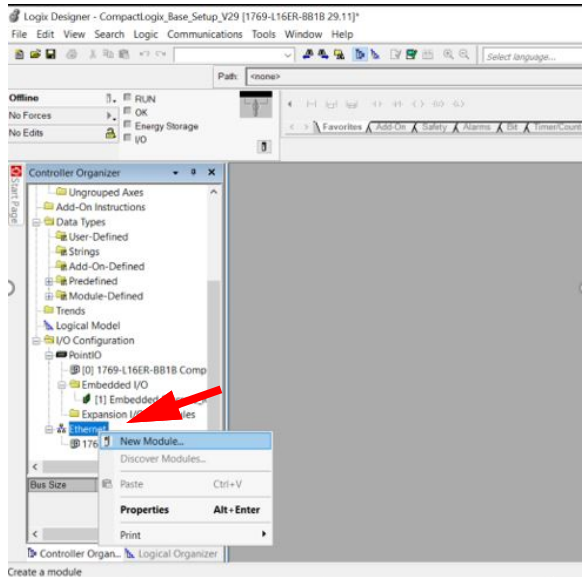

4. Select Module Type: ETHERNET-MODULE.

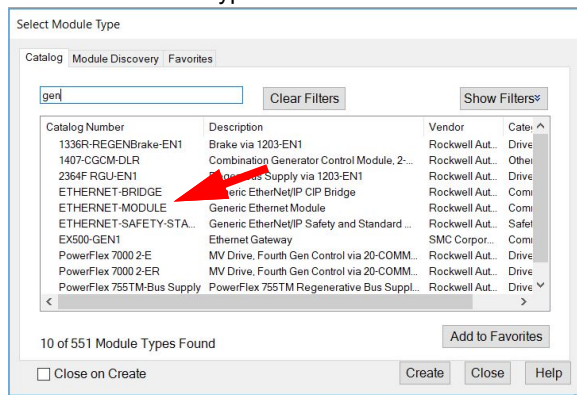

The ACS880+N5350 CTDD only supports the 16 Bit Transparent assembly instances displayed below.

Input Assembly Instances	Output Assembly Instances	PLC Word Settings
61	11	2
62	12	3
161	111	12
162	112	13

Reference FEIP-21 Ethernet/IP adapter module user's manual section "Communication" and FENA-01 /-11/-21 Ethernet adapter module user's manual for more information on Input/Output Assembly Instances.

1. Enter the following information. The example shown is using the B16 Bit Transparent Profile Assembly Instances 112 and 162. The PLC will transmit and receive 13 words of information.
2. Enter the name that will be given to the CTDD
3. Change Comm Format to Data - INT (16Bits)
4. Enter the IP Address of the Ethernet option card
5. Enter Input and Output Assembly Instances numbers.

## 98 Ethernet/IP Setup

6. Enter configuration instance as 1 and size as 0.

The 'New Module' dialog box is shown with the following configuration:

- Type: ETHERNET-MODULE Generic Ethernet Module
- Vendor: Rockwell Automation/Allen-Bradley
- Parent: Local
- Name: ACS880\_CTDD
- Description: (empty)
- Comm Format: Data-INT
- Address / Host Name: IP Address: 192 . 168 . 3 . 88
- Connection Parameters:
  - Input: 162
  - Output: 112
  - Configuration: 1
  - Assembly Instance: 13
  - Size: 0

7. Click Finish.

The ACS880 CTDD is now added to the PLC I/O.

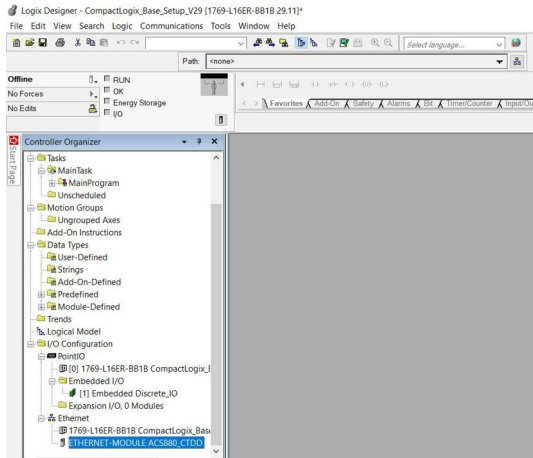

# 15

## Modbus TCP Setup

### ACS880 CTDD

#### Modbus TCP Setup

This document will guide you through the process of setting up the ACS880+N5350 CTDD for monitoring and control over Modbus TCP using the following data in and out:



#### Setting fieldbus Parameters

This guide assumes that the two startup assistants have been run. Note that fieldbus must have already been selected. (Refer to Chapter 10) Follow the remaining steps to configure Modbus TCP.

1. Once this basic drive setup has been completed, set the following parameters:

96.02 Pass Code = Fieldbus. This opens parameter group 50 - 58.	
<b>Group 50 Fieldbus adapter (FBA)</b>	
50.01 FBA A Enable = Option Slot 1	This is the top option slot on the drive. Adapter can go in any slot
50.02 FBA A Comm Loss Function = Warning	This setting determines what the drive does when comms are lost
50.03 FBA A Comm Loss Timeout = 3sec	This time is added to the time in 51.20 before issuing a fault warning
50.04 FBA A ref1 Type = Speed	
50.07 FBA A Act 1 type = Speed	
50.08 FBA A Act 2 type = Torque	
<b>Group 51 FBA A settings (Ethernet Adapter Setup)</b>	
51.01 FBA A Type = EtherNet	
51.02 Protocol/Profile = MB/TCP T16	Transparent 16 Profile
51.03 Comm Rate = Auto	Automatically adjusts to 10 or 100Mbit/s network speed
51.04 IP Configuration = STATIC	
51.05 IP Address	ex. 192

## 100 Modbus TCP Setup

51.06 IP Address	ex. 168
51.07 IP Address	ex. 0
51.08 IP Address	ex. 10
51.09 Subnet CIDR = 24	Shorthand for 255.255.255.0
51.10 GW Address	Leave at default (zero) if not used
51.11 GW Address	Leave at default (zero) if not used
51.12 GW Address	Leave at default (zero) if not used
51.13 GW Address	Leave at default (zero) if not used
51.20 Timeout Time = 30	3 sec (value put here is multiplied times 100ms)
51.21 Timeout Mode = Control RW	Monitors updating of CW and REF1
<b>Group 52 FBA A data in (PLC Input Data)</b>	
(Note: that first three words back to PLC are pre-defined or already mapped for you.)	
Status Word (SW)	Register 40051. See status word bit description below
Actual Value 1 =	Register 40052. Speed (1=1rpm)
Actual Value 2 =	Register 40053. Torque (% of motor nominal x 100)
52.01 FBA A Data In1 = Parameter 1.07	Register 40054. Motor Current (1=1Amp)
52.02 FBA A Data In2 = Parameter 1.11	Register 40055. DC Bus Voltage x 10
52.03 FBA A Data In3 = Parameter 1.14	Register 40056. Actual motor power in HP x 10
52.04 FBA A Data In4...	Register 40065. These additional data words could be used to read other parameters from the drive.
52.12 FBA A Data In12	Register 40065. These additional data words could be used to read other parameters from the drive.
<b>Group 53 FBA A data out (PLC Output Data)</b>	
(Note: the first three words sent to the drive are pre-defined or already mapped for you.)	
Control Word (CW)	Register 40001. See control word bit description below
Ref 1	Register 40002. Scaling is 1=1rpm
Ref 2	Register 40003. Not used.
53.01 FBA A Data Out1 = Parameter 23.12	Register 40004. (optional) These additional data words could be used to write to other parameters. For example, writing a value of 300 here would set par 23.12 Accel Time 1 to 30 seconds.
53.02 FBA A Data Out 2...	Register 40015. These additional parameters can be mapped here for cyclic updating
53.12 FBA A Data Out12	Register 40015. These additional parameters can be mapped here for cyclic updating

2. Set parameter 51.27 to Refresh. This reboots the fieldbus card so changes can take effect.

Communication should now be established. PING the drive at the IP address above to verify communication. Make sure your laptop IP address is on the same subnet as the drive. This completes setup for Modbus TCP.

### Simulating PLC using ModbusPoll SW

As an option, you can simulate a ModbusTCP master using the ModbusPoll Software. Some familiarity with this software is assumed.

1. On your PC configure the Modbus Poll Read/Write definitions as shown below.

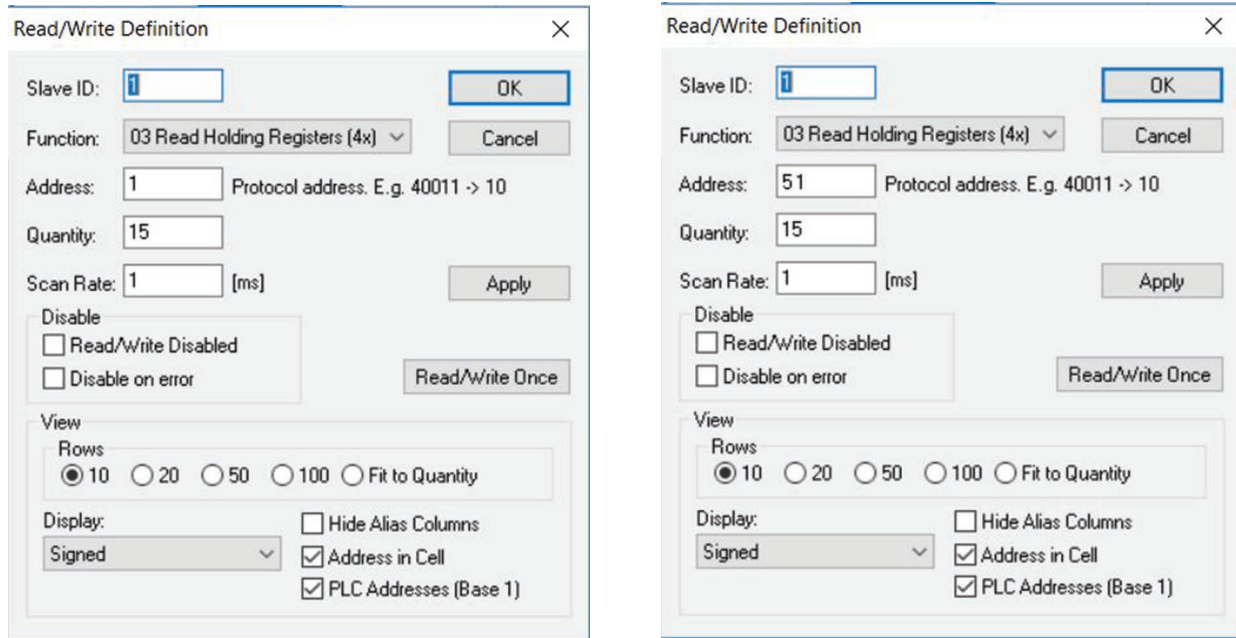

2. Then click “Connection” from the top menu, and select “Connect”.

The window below will appear.

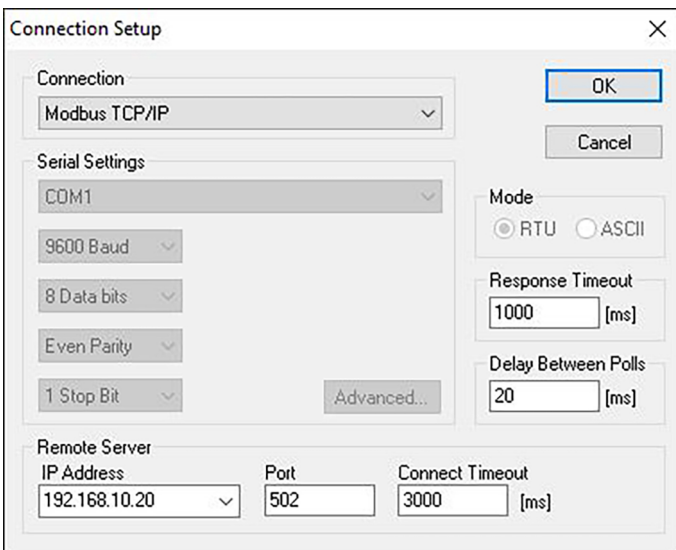

3. Connection type is Modbus TCP/IP. For the “Remote Server” IP address enter the drive’s IP address.

4. Click OK.

You should now see the packet counters at the top of the windows begin to increment. This indicates that data is being sent to, and received from, the drive.

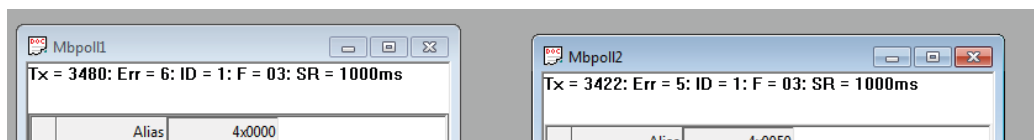

## 102 Modbus TCP Setup

You should also be receiving a “live” bus voltage value. Looking at bus voltage (a value that constantly changes) is a good way to verify working communication.

5. You can now simulate a PLC with the screens below.

### PLC OUTPUT DATA

	Alias	4x0000	Alias	4x0010
1	Main Control Word	40001 = 000000	Data out 8 (Par 53.08)	40011 = 000000
2	Ref 1 Speed	40002 = 000000	Data out 9 (Par 53.09)	40012 = 000000
3	Ref 2 - Not used	40003 = 000000	Data out 10 (Par 53.10)	40013 = 000000
4	Data out 1 (Par 53.01)	40004 = 000000	Data out 11 (Par 53.11)	40014 = 000000
5	Data out 2 (Par 53.02)	40005 = 000000	Data out 12 (Par 53.12)	40015 = 000000
6	Data out 3 (Par 53.03)	40006 = 000000		
7	Data out 4 (Par 53.04)	40007 = 000000		
8	Data out 5 (Par 53.05)	40008 = 000000		
9	Data out 6 (Par 53.06)	40009 = 000000		
10	Data out 7 (Par 53.07)	40010 = 000000		

### PLC INPUT DATA

	Alias	4x0050	Alias	4x0060
1	Main Status Word	40051 = 000561	Data in 8 (Par 52.08)	40061 = 000000
2	Act Speed (1 unit = 1 RPM)	40052 = 000000	Data in 9 (Par 52.09)	40062 = 000000
3	Act Torque (1 unit = 0.01 %)	40053 = 000000	Data in 10 (Par 52.10)	40063 = 000000
4	Data in 1 (Par 52.01)	40054 = 000000	Data in 11 (Par 52.11)	40064 = 000000
5	Data in 2 (Par 52.02)	40055 = 000000	Data in 12 (Par 52.12)	40065 = 000000
6	Data in 3 (Par 52.03)	40056 = 000000		
7	Data in 4 (Par 52.04)	40057 = 000000		
8	Data in 5 (Par 52.05)	40058 = 000000		
9	Data in 6 (Par 52.06)	40059 = 000000		
10	Data in 7 (Par 52.07)	40060 = 000000		

## Controlling the drive over fieldbus:

If the drive will ONLY be controlled over fieldbus, then DI2 must be jumpered to +24V.

### Control Word bit structure

These bits control the function of the drive:

Bit	Name	Value	Description
0	Ready to switch ON	1	Ready to switch ON
		0	Not ready to switch ON
1	Ready run	1	Ready to operate
		0	OFF1 active
2	Ready ref	1	Operation enabled
		0	Operation inhibited
3	Tripped	1	Fault
		0	No Fault
4	OFF2 inactive	1	OFF2 inactive
		0	OFF2 active
5	OFF3 inactive	1	OFF3 inactive
		0	OFF3 active
6	Switch-on inhibited	1	Switch-on inhibited
		0	--
7	Warning	1	Warning active
		0	No warning active
8	At setpoint	1	Operating - Actual value equals reference = is within tolerance limits (see parameters 46.21 - 46.23)
		0	Actual value differs from reference = is outside tolerance limits
9	Remote	1	Drive control location: Remote (EXT1 or EXT2)
		0	Drive control location: Local
10	Trickle Current Active	1	Trickle Current ON
		0	Trickle Current OFF
11	De-Ice Mode Active	1	De-Ice Mode ON
		0	De-Ice Mode OFF

12	CTDD Run	1	CTDD Running
		0	CTDD Not Running
13	CTDD HOLD	1	CTDD Autophase ON
		0	CTDD Autophase OFF
14	Trickle Rotate Active	1	Trickle Current Rotation Enabled
		0	Trickle current Rotation Disabled
15	Reserved		

Turning a bit ON will cause that function to start. Only one function should be ON at a time.

As an example, lets start the drive and run at 100 rpm. Follow the steps below:

1. Write a value of 100 to REF1 for the speed reference. (100 rpm)
2. Set CW bit 2 = 1 by writing a decimal value of 4 to the CW. (drive should start)

The screens in Modbus Poll should look like this.

**PLC OUTPUT DATA**

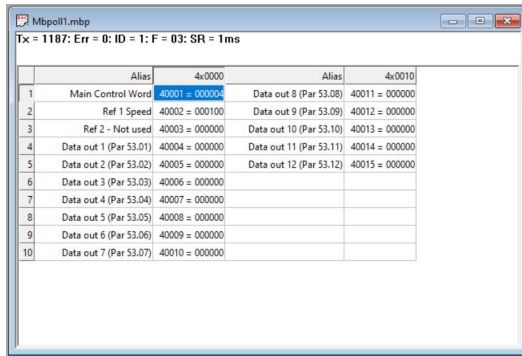

**PLC INPUT DATA**

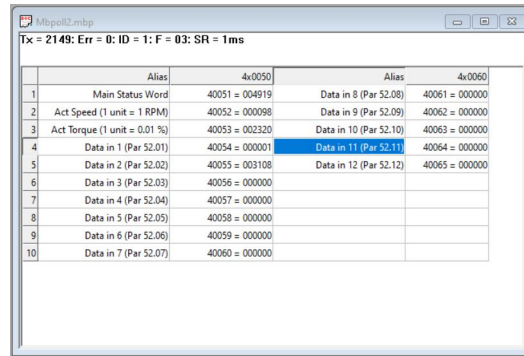

Refer to CTDD status in the Main Status Word (SW) in par 6.11:

Bit	Name	Value	Description
0	Ready to switch ON	1	Ready to switch ON
		0	Not ready to switch ON
1	Ready run	1	Ready to operate
		0	OFF1 active
2	Ready ref	1	Operation enabled
		0	Operation inhibited
3	Tripped	1	Fault
		0	No Fault
4	OFF2 inactive	1	OFF2 inactive
		0	OFF2 active
5	OFF3 inactive	1	OFF3 inactive
		0	OFF3 active
6	Switch-on inhibited	1	Switch-on inhibited
		0	--
7	Warning	1	Warning active
		0	No warning active
8	At setpoint	1	Operating - Actual value equals reference = is within tolerance limits (see parameters 46.21 - 46.23)
		0	Actual value differs from reference = is outside tolerance limits

## 104 Modbus TCP Setup

9	Remote	1	Drive control location: Remote (EXT1 or EXT2)
		0	Drive control location: Local
10	Trickle Current Active	1	Trickle Current ON
		0	Trickle Current OFF
11	De-Ice Mode Active	1	De-Ice Mode ON
		0	De-Ice Mode OFF
12	CTDD Run	1	CTDD Running
		0	CTDD Not Running
13	CTDD HOLD	1	CTDD Autophase ON
		0	CTDD Autophase OFF
14	Trickle Rotate Active	1	Trickle Current Rotation Enabled
		0	Trickle current Rotation Disabled
15	Reserved		

### Troubleshooting:

- Verify the CW being received by the drive by looking at par 6.05 EFB Transparent Control Word. This will be the raw value being sent by the PLC.
  - Verify the current speed reference being used by the drive by looking at par 47.01 DataStorage 1. This parameter will contain the active reference whether it comes from Embedded Fieldbus or an analog input.
-



*Page intentionally left blank*



---

## Further information

### **Product and service inquiries**

Address any inquiries about the product to your local ABB representative, quoting the type designation and serial number of the unit in question. A listing of ABB sales, support and service contacts can be found by navigating to [abb.com/searchchannels](http://abb.com/searchchannels).

### **Providing feedback on ABB Drives manuals**

Your comments on our manuals are welcome. Navigate to [new.abb.com/drives/manuals-feedback-form](http://new.abb.com/drives/manuals-feedback-form).

### **Document library on the Internet**

You can find manuals and other product documents in PDF format on the Internet at [library.abb.com](http://library.abb.com).

---

*Page intentionally left blank*



[abb.com/drives](http://abb.com/drives)

