

ABB JOKAB SAFETY Products

# Safety contact mats

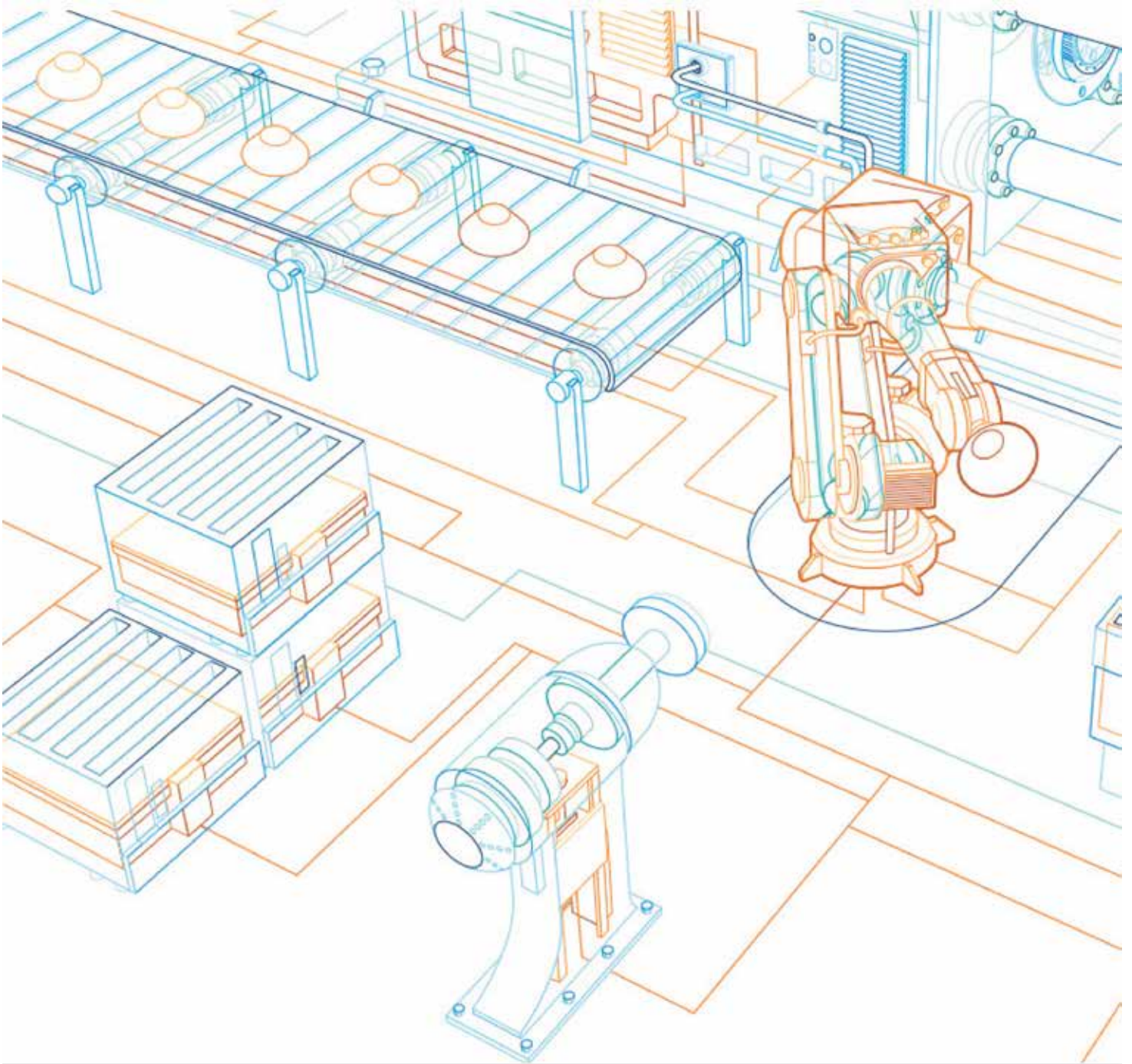

Disclaimer: This document and any attachments may include suggested specifications, drawings, schematics and similar materials from ABB. Use of such information and/or documentation by the recipient is subject to and conditioned upon your acceptance of the terms of the General Document Disclaimer which can be found at [www.abb.com/jokabsafety](http://www.abb.com/jokabsafety). Your acceptance of the terms of such General Document Disclaimer is conclusively presumed unless you notify ABB in writing of your disagreement with the terms of such Disclaimer immediately upon receipt of this document and you return to ABB all specifications, drawings, schematics and similar materials provided to you by ABB in this document.

# When should I use safety mats?

## A safety mat is used as personal protection within dangerous areas

The ABB JOKAB SAFETY contact mat is used for safeguarding sections in hazardous areas around machines, presses, robots and other types of active equipment. When connected to a suitable monitoring system, stepping on the mat surface triggers a control signal to the stop circuit of the potentially hazardous motion. This fast contact occurs due to the area switch design on the inside of the mat.

An anti-slip surface is also implemented into the design. Safety mats must be connected to a suitable monitoring unit (e.g. ABB JOKAB SAFETY safety relays RT6, RT7A/B, RT9, Vital with Tina 6A or Pluto Safety PLC).

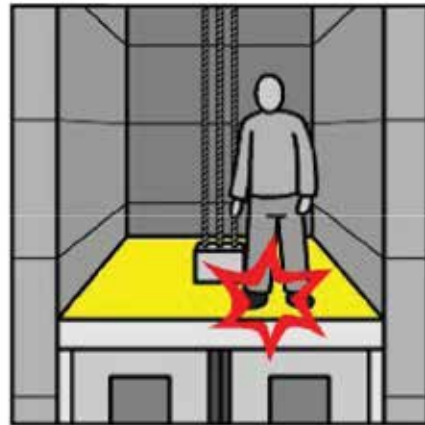

# Safety mat construction

The basic construction of the ABB JOKAB SAFETY mat consists of two conductive plates that are separated by a proprietary isolating layer. These plates are completely placed in a polyurethane material so that they are impervious to oil, water and dirt. The top consists of a slip resistant dotted pattern. This surface provides excellent resistance against oil and grease. Mounting to the floor can be realized with either aluminum ramp rails or integrated rubber ramp trim.

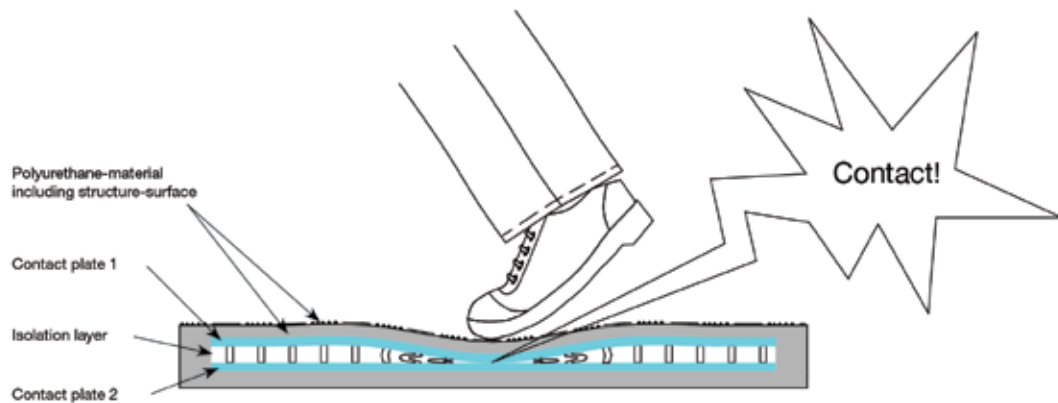

## Safety mat surface layer

Safety mats are normally supplied with a dotted polyurethane non-slip surface layer that withstands tough conditions very well (oil, acid or caustic substances) and has anti-slip properties. If required, other patterns can be supplied, or for special requirements, even other materials. Please contact us for more information about these alternatives.

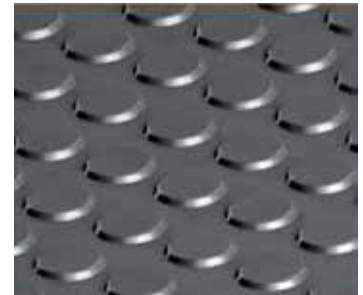

## Safety mat electrical connection

Safety mats must be connected to a suitable monitoring unit (e.g. ABB JOKAB SAFETY safety relays RT6, RT7A/B, RT9, Vital with Tina 6A or Pluto Safety PLC). The monitoring unit monitors the functionality of the contact protection and detects any breaks or short-circuits in the lines. Several safety mats can be connected in series while still retaining the same level of safety.

When pressure is applied, the active surface of the contact area in the contact protection is closed and the safety output on the monitoring unit trips. A stop signal will be sent to the machine's safety circuits preventing any dangerous movements. Safety mats are supplied with a 4 conductor 10 m cable exiting out the middle of the long side. Conductors 1 and 3 are connected to the top plate (safety channel 1) and conductors 2 and 4 are connected to the bottom plate (safety channel 2).

Note: If alternative units are used rather than the recommended ABB JOKAB SAFETY relays, it is essential that the user checks their suitability with ABB JOKAB SAFETY before use. Failure to do so may result in incorrect operation and/or damage to the safety mat and thereby invalidate warranty.



# Safety mat mounting

Mats should be installed on ground that is level, clean and dry. The mats should not be glued to the ground. If more than one mat is to be installed, they must be placed edge to edge (without space).

Note: Safety mats must not be rolled/twisted or modified in any way. It is also essential that mats are not cut into any shape or shortened following delivery.

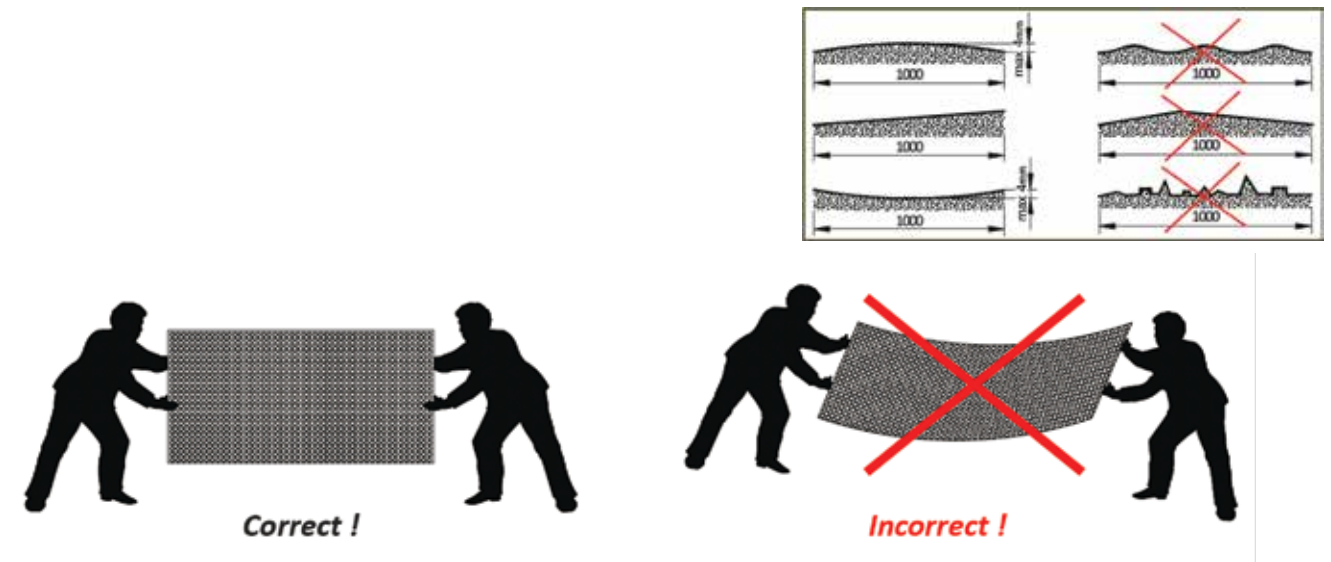

# Safety mat mounting

## Safety mat mounting – integrated ramp trim

For safety mats with cast-in rubber edge trim, the mat should be secured to the floor by screws through the edge of trim. When placing several mats side by side, the relevant integrated rubber ramp rails must be cut off. To do this, cut off the ramp rail with a knife in the given slit (spray the knife and the cutting area with soapy water).

### Please note for over measure:

The areas to be safeguarded are made up by the dimension of the safety contact mat and the dimensions of 70 mm/2.8" (for the ramp rail) must be added to this. The sum gives the total area required. The ramp rails are required for holding the mat in position on the floor.

The maximum size that can be manufactured is 4' x 6'. Sizes greater than this can be realized by sequencing several single mats together.

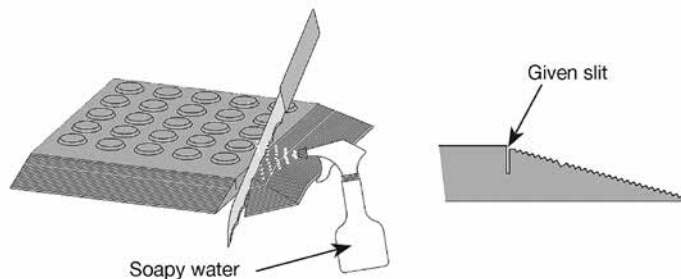
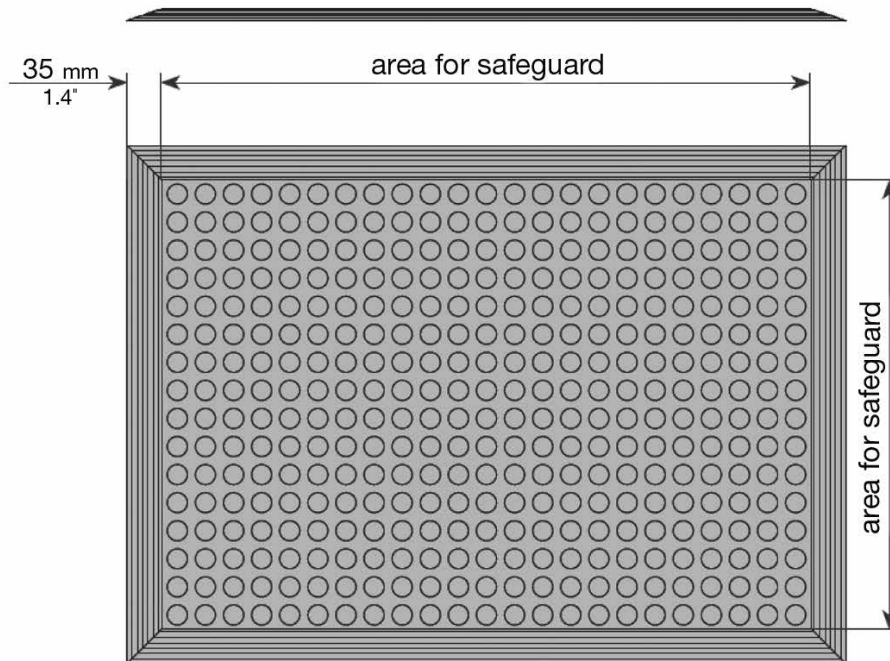
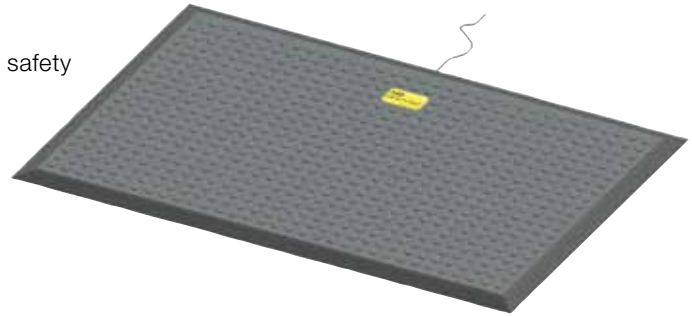

# Safety mat mounting

## Safety mat mounting – aluminum ramp trim

For safety mats with an aluminum edge trim, see below. Place the selected edge trim to the mat. Mark the locations of the securing screws along the scribed line on the edge trim. It is recommended that fixing screws should be located at 60 cm spacing. Secure the edge trim to the ground with 6 mm plugs and suitable screws. Plug the holes above the screws in the edge trim with the cover plugs provided.

When using corner connectors, the ramp rail must be shortened around 20 mm for each corner connector. The corner connector nearest the cable should be mounted from above over the cable in such a way that the cable is guided safely in the cable duct (Fig. 1). Afterwards, drill and fasten it to the bottom with a 6 mm dowel and suitable screw.

Push the ramp rails laterally to the mat and then on the fixation pin of the corner connector (Fig. 2). Mark the fastening points along the marking groove on the rail and predrill 10 mm for the intended plugs. Fasten the rails on the bottom with 6 mm dowels and suitable screws (approximately all 60 cm) and close the openings with the plugs (Fig. 3, next page).

Push the corner connectors laterally to the mat and then the fixation pin into the rail. Afterwards, drill and fasten it to the bottom with a 6 mm dowel and suitable screw.

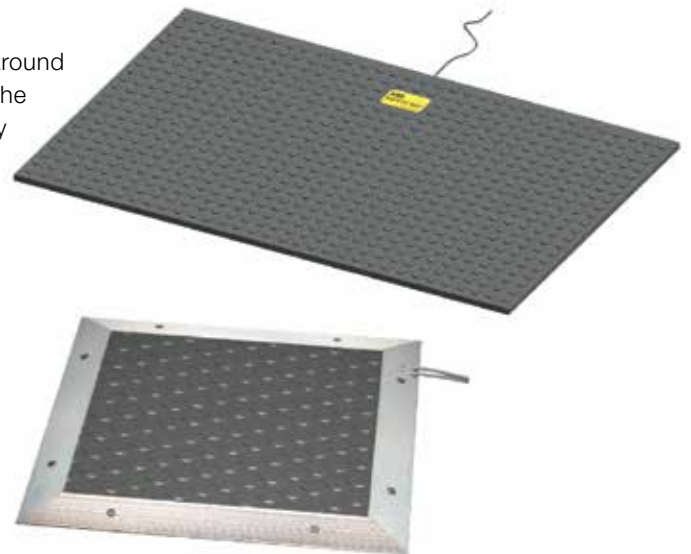

Fig. 1

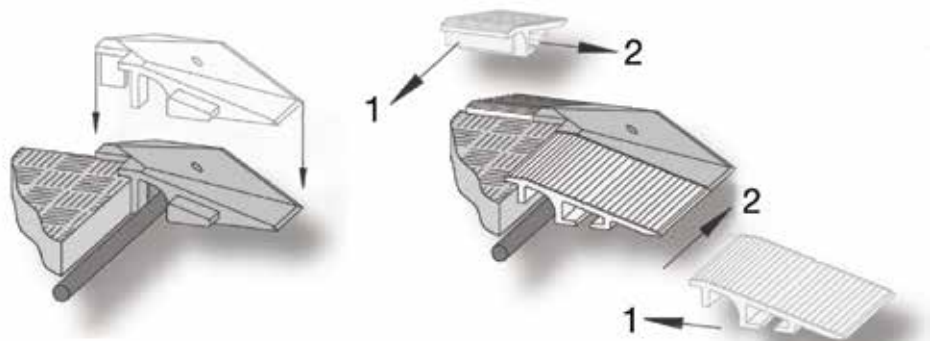
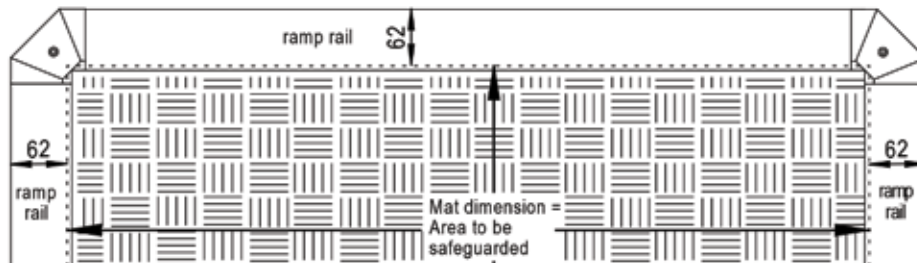
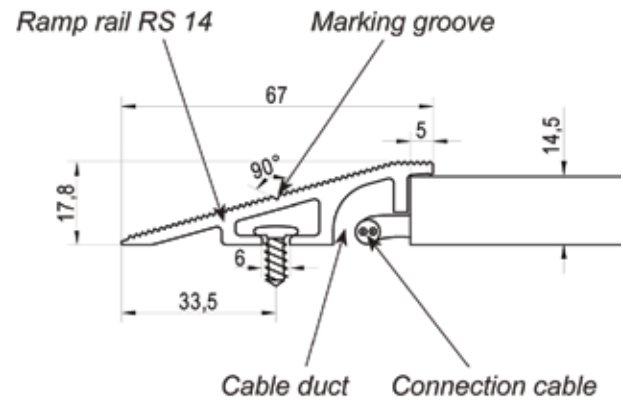
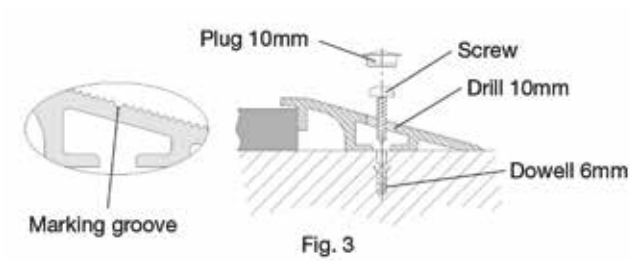

Fig. 2

# Safety mat mounting



## Please note for over measure:

The areas to be safeguarded are made up by the dimension of the safety contact mat and the dimensions of 62 mm (for the ramp rail) must be added to this. The sum gives the total area required. The ramp rails are required for holding the mat in position on the floor.

The maximum size that can be manufactured is 4' x 6'. Sizes greater than this can be realized by sequencing several single mats together.





# Ordering data

## Safety mat without integrated trim

Material number	Material description
2TLA858003R2800	Safety mat w/o trim 12" x 12"
2TLA858002R3800	Safety mat w/o trim 24" x 24"
2TLA858002R3900	Safety mat w/o trim 24" x 30"
2TLA858002R4000	Safety mat w/o trim 24" x 36"
2TLA858002R4100	Safety mat w/o trim 24" x 42"
2TLA858002R4200	Safety mat w/o trim 24" x 48"
2TLA858002R4300	Safety mat w/o trim 24" x 60"
2TLA858002R4400	Safety mat w/o trim 30" x 30"
2TLA858002R4500	Safety mat w/o trim 30" x 36"
2TLA858002R4600	Safety mat w/o trim 30" x 42"
2TLA858002R4700	Safety mat w/o trim 30" x 48"
2TLA858002R4800	Safety mat w/o trim 36" x 36"
2TLA858002R4900	Safety mat w/o trim 36" x 42"
2TLA858002R5000	Safety mat w/o trim 36" x 48"
2TLA858002R5100	Safety mat w/o trim 36" x 60"
2TLA858002R5200	Safety mat w/o trim 42" x 42"
2TLA858002R5300	Safety mat w/o trim 42" x 48"
2TLA858002R5400	Safety mat w/o trim 48" x 48"
2TLA858002R5500	Safety mat w/o trim 48" x 60"

## Safety mat with integrated trim

Material number	Material description
2TLA858003R2900	Safety mat w trim 12" x 12"
2TLA858002R5600	Safety mat w trim 24" x 24"
2TLA858002R5700	Safety mat w trim 24" x 30"
2TLA858002R5800	Safety mat w trim 24" x 36"
2TLA858002R5900	Safety mat w trim 24" x 42"
2TLA858002R6000	Safety mat w trim 24" x 48"
2TLA858002R6100	Safety mat w trim 24" x 60"
2TLA858002R6200	Safety mat w trim 30" x 30"
2TLA858002R6300	Safety mat w trim 30" x 36"
2TLA858002R6400	Safety mat w trim 30" x 42"
2TLA858002R6500	Safety mat w trim 30" x 48"
2TLA858002R6600	Safety mat w trim 36" x 36"
2TLA858002R6700	Safety mat w trim 36" x 42"
2TLA858002R6800	Safety mat w trim 36" x 48"
2TLA858002R6900	Safety mat w trim 36" x 60"
2TLA858002R7000	Safety mat w trim 42" x 42"
2TLA858002R7100	Safety mat w trim 42" x 48"
2TLA858002R7200	Safety mat w trim 48" x 48"
2TLA858002R7300	Safety mat w trim 48" x 60"

Note: Custom non-stocked safety mats are available upon request.

## Safety mat aluminum trim

Material number	Material description
2TLA858002R7400	Safety mat trim corner connection
2TLA858002R7500	Safety mat aluminum trim (by the inch)
2TLA858002R7600	Safety mat demo sample

**For Order Entry Support or Technical Support, please contact:  
ABB JOKAB SAFETY  
at  
1-888-282-2123**

# Aluminum trim calculations

## Cutting of trim for safety mats when corner connectors are used (Trim Article #2TLA858002R7500)

Length of side of mat	0.8 inches removed for each corner connector	Size of trim that needs to be cut
6 inches	- 1.58 inches	5 inches
12 inches	- 1.58 inches	11 inches
18 inches	- 1.58 inches	17 inches
24 inches	- 1.58 inches	23 inches
30 inches	- 1.58 inches	29 inches
36 inches	- 1.58 inches	35 inches
42 inches	- 1.58 inches	41 inches
48 inches	- 1.58 inches	47 inches
54 inches	- 1.58 inches	53 inches
60 inches	- 1.58 inches	59 inches
66 inches	- 1.58 inches	65 inches
72 inches	- 1.58 inches	71 inches
78 inches	- 1.58 inches	77 inches
84 inches	- 1.58 inches	83 inches
90 inches	- 1.58 inches	89 inches
96 inches	- 1.58 inches	95 inches
102 inches	- 1.58 inches	101 inches
108 inches	- 1.58 inches	107 inches
114 inches	- 1.58 inches	113 inches
120 inches	- 1.58 inches	119 inches

Note: 10 ft. trim is in stock.

### Example Cut

If a safety mat 24 x 30 without built-in trim is ordered, the following aluminum trim pieces and corner pieces would also need to be ordered:

Quantity	Part Number	Description
23	2TLA858002R7500	Safety mat aluminum trim (by the inch)
23	2TLA858002R7500	Safety mat aluminum trim (by the inch)
29	2TLA858002R7500	Safety mat aluminum trim (by the inch)
29	2TLA858002R7500	Safety mat aluminum trim (by the inch)
4	2TLA858002R7400	Safety mat trim corner connection

Note: Do not combine multiple lengths into one line item. Each line item must reflect one piece of aluminum trim cut to a specific required length.

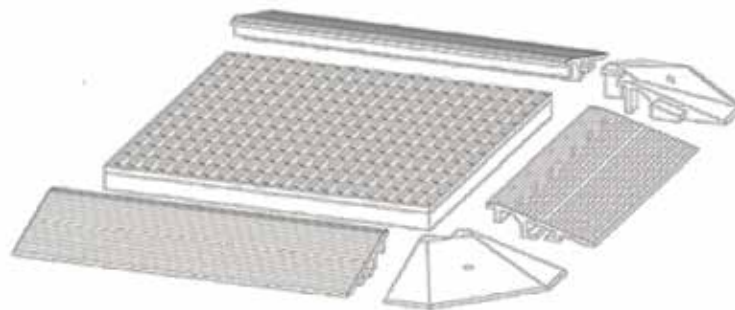

# Contact us

## **ABB**

ABB JOKAB SAFETY Products

8155 T&B Boulevard

Memphis, TN 38125

Phone: 1-888-282-2123

Fax: 1-800-565-9302

Web: [www.abb.us/jokabsafety](http://www.abb.us/jokabsafety)

1SXU172019C0201, February 2016