



FREEWAVE  
RADIO  
DGR09RFS  
REV AE  
OR  
REV AH  
FGR2-C-U  
LRS455-C-U  
FGRIO-M/S   
RS232  
OPERATION

MODEL  
ELEK PCBA  
TERM PCBA  
COMM  
I/O OPTION  
PCBA

6413/6414  
XFC6713/6714  
2015333-XXX  
2100204-XXX  
2102838-XXX  
XFC G4

1



6413/6414  
XFC6713/6714  
2015333-XXX  
2100204-XXX  
2102838-XXX  
XFC G4

2



6790  
2017245-XXX  
2015080-XXX  
2010232-XXX



6713/6714  
2015382-XXX

1

RS232 COMM  
MODULE  
OR  
RS232 PCBA



6713/6714  
2015382-XXX

2

RS232 COMM  
MODULE



6713/6714  
2015382-XXX

3

RS232 COMM  
MODULE



UCI2  
2017266-XXX

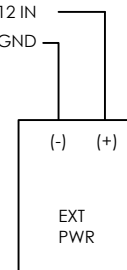
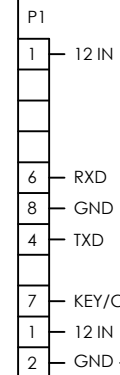
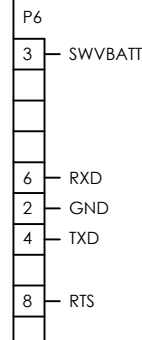
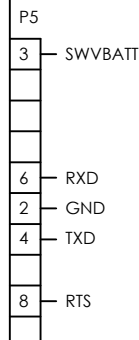
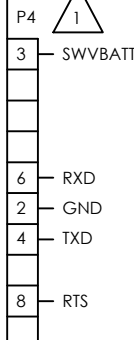
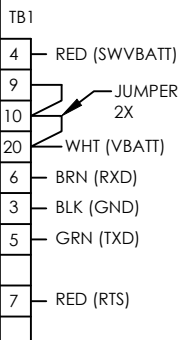
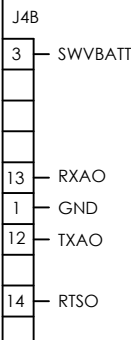
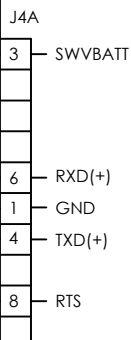
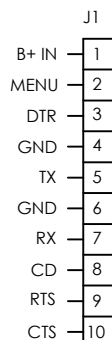

USE CABLE NO.  
2100759-001

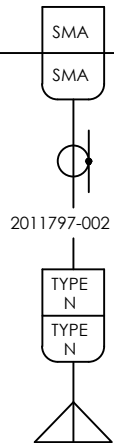

UCI2 RS485 TO  
6400 FCU - 2017398-WI  
67XX FCU - 2017399-WI  
6790 RTU - 2015194-WI  
66XX FCU - 2017400-WI

SCALE	SIZE	DOC TYPE	DRAWING NO.	REV	SHEET
NONE	B	WI	2100527	AT	2 OF

FREEWAVE  
RADIO  
DGR09RFS  
REV AE  
OR  
REV AH

FGR2-C-U  
LRS455-C-U

FGRIO-M/S 4

RS232  
OPERATION

MODEL  
ELEK PCBA  
  
TERM PCBA  
  
COMM  
  
I/O OPTION  
PCBA

6490/6890/6895  
XRC6790  
2100355-XXX  
2103022-XXX  
XRC G4

1



6490/6890/6895  
XRC6790  
2100355-XXX  
2103022-XXX  
XRC G4

2



66XX FCU 3  
2000028-XXX  
2010020-XXX  
2010054-XXX  
2010282-XXX  
2011772-XXX  
2012803-XXX



6470/6770 3  
O.E.U.  
2018339-001



UFLO6213 3  
MEASUREMENT UNIT W/PCBA  
• 2100767-XXX  
• 2103082-XXX  
UFLO G4



WARNING -  
SEE NOTE

UFLO6213 3  
MEASUREMENT UNIT W/PCBA  
• 2100767-XXX  
• 2103082-XXX  
UFLO G4

W/2100888-002  
OR  
2101059-002  
COMM MODULE

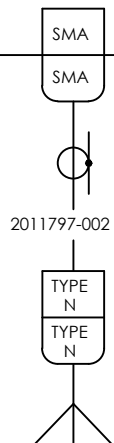
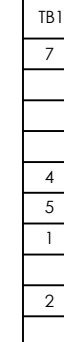
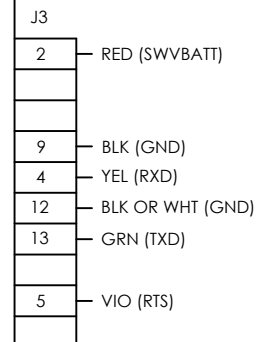
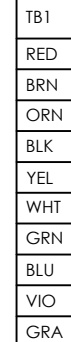
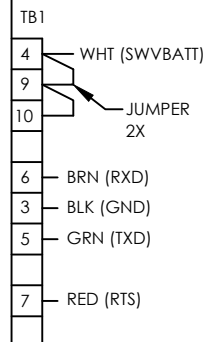
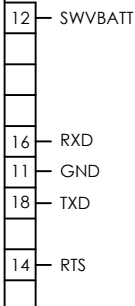
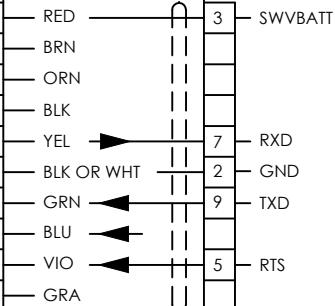
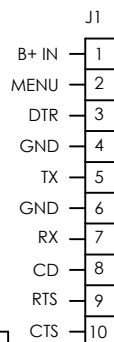

USE CABLE NO.  
2100759-001  
2100759-006 (6895)

USE CABLE NO.  
2100759-005

USE CABLE NO.  
2100759-001

SCALE	SIZE	DOC TYPE	DRAWING NO.	REV	SHEET
NONE	B	WI	2100527	AT	3 OF

FREEWAVE  
RADIO  
DGR09RFS  
REV AE

FREEWAVE  
INTERFACE  
PCBA  
2100145-001

MODEL	6413/6414 XFC6713/14	6413/6414 XFC6713/14	6790	6713/6714	6713/6714	6713/6714	UCI2
ELEK PCBA	2015333-XXX 2100204-XXX	2015333-XXX 2100204-XXX	2017245-XXX 2015080-XXX	2015382-XXX	2015382-XXX	2015382-XXX	2017266-XXX
TERM PCBA	2103022-XXX XFC G4	2103022-XXX XFC G4	2010232-XXX				
COMM	1	2		1	2	3	
I/O OPTION PCBA				RS232 COMM MODULE OR RS232 PCBA	RS232 COMM MODULE	RS232 COMM MODULE	

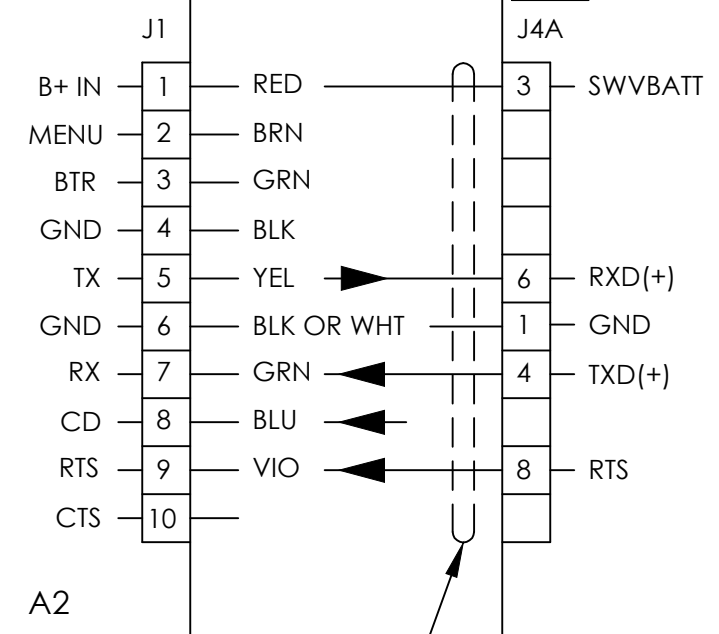

USE CABLE NO.  
2100759-001

A1

A2

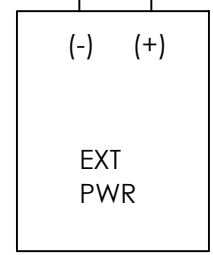
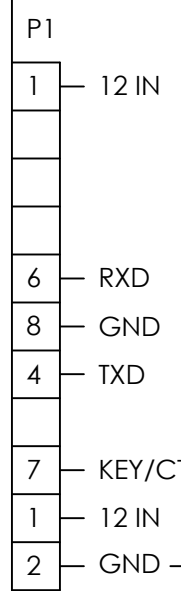

UCI2 RS485 TO  
6400 FCU - 2017398-WI  
67XX FCU - 2017399-WI  
6790 RTU - 2015194-WI  
66XX FCU - 2017400-WI

FREEWAVE  
RADIO  
DGR09RFS  
REV AE  
RS232  
OPERATION

FREEWAVE  
INTERFACE  
PCBA  
2100145-001

MODEL 6490/6890  
XRC6790

ELEK PCBA 2100355-XXX  
2103022-XXX  
XRC G4

TERM PCBA

COMM 1

I/O OPTION  
PCBA

6490/6890  
XRC6790

2100355-XXX  
2103022-XXX  
XRC G4

2

66XX FCU 

2000028-XXX  
2010020-XXX  
2010054-XXX  
2010282-XXX  
2011772-XXX  
2012803-XXX

2010232-XXX

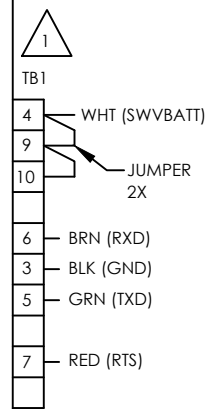
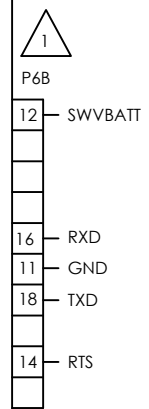
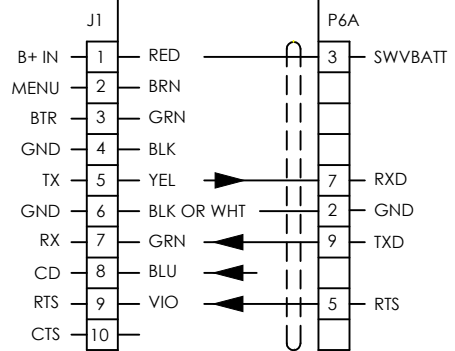
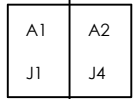

USE CABLE NO.  
2100759-001

FREEWAVE  
RADIO  
FGR09CSU

FGR2-C-U  
LRS455-C-U

FGRIO-M/S 4

RS485  
OPERATION

MODEL

ELEK PCBA

TERM PCBA

COMM

I/O OPTION  
PCBA

6413/6414  
XFC6713/14

2015333-XXX  
2100204-XXX  
2102838-XXX  
XFC G4

1

6413/6414  
XFC6713/14

2015333-XXX  
2100204-XXX  
2102838-XXX  
XFC G4

2

6790

2017245-XXX  
2015080-XXX

2010232-XXX

6713/6714

2015382-XXX

1  
RS485 COMM  
MODULE

6713/6714

2015382-XXX

2  
RS485 COMM  
MODULE

6713/6714

2015382-XXX

3  
RS485 COMM  
MODULE

LMC7100  
12V/RS485 BARRIER 3

2100336-XXX

LMC BARRIER BOARD

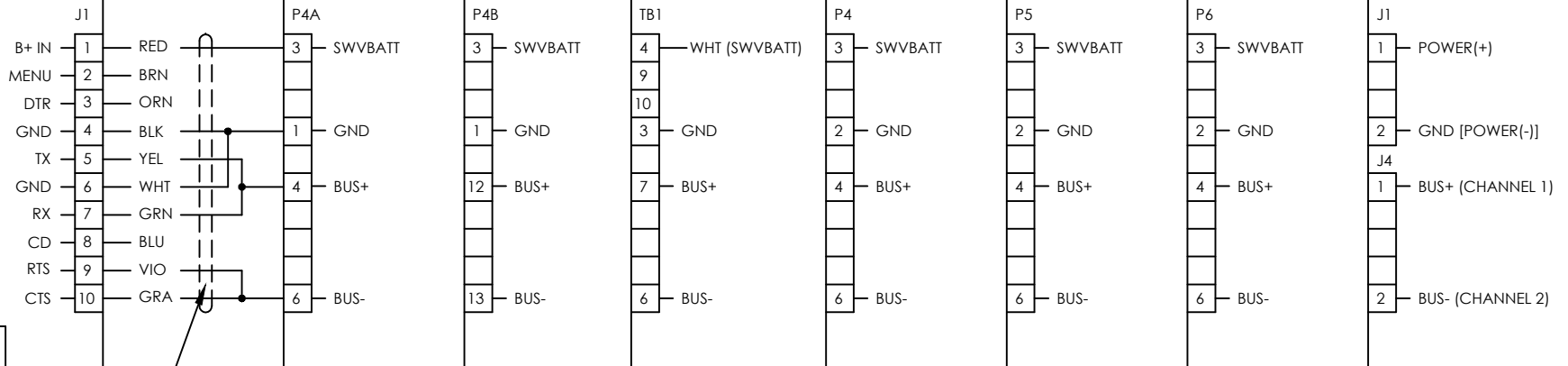

USE CABLE NO.  
2100759-004 PRE-SPLICED  
OR  
2100759-001

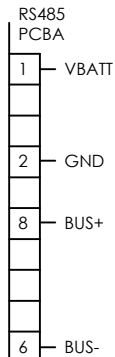
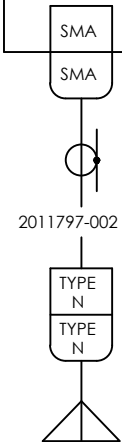

SCALE	SIZE	DOC TYPE	DRAWING NO.	REV	SHEET
NONE	B	WI	2100527	AT	6 OF

FREEWAVE  
RADIO  
FGR09CSU  
FGRIO-M/S 4

FGR2-C-U  
LRS455-C-U

RS485  
OPERATION

MODEL

ELEK PCBA

TERM PCBA

COMM

I/O OPTION  
PCBA

RTU

6490/6790/6890/  
6895

2100355-XXX

2103022-XXX  
XRC G4

1

RTU

6490/6790/6890/  
6895

2100355-XXX

2103022-XXX  
XRC G4

2

66XX FCU 3

2000028-XXX  
2010020-XXX  
2010054-XXX  
2010282-XXX  
2011772-XXX  
2012803-XXX

2010232-XXX

6470/6770  
O.E.U. 3

2018339-001

XFC6413/6414

2100204-XXX

2102838-XXX  
XFC G4

1

XFC6413/6414

2100204-XXX

2102838-XXX  
XFC G4

2

UFLO6213 3

MEASUREMENT UNIT W/PCBA  
● 2100767-XXX  
● 2103082-XXX  
UFLO G4

W/2100888-001  
OR  
2101059-001  
COMM MODULE

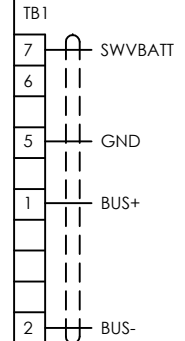
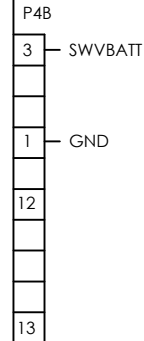
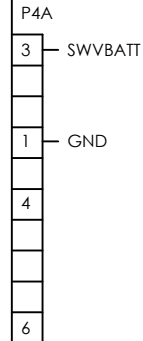
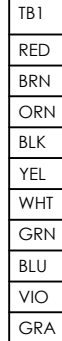
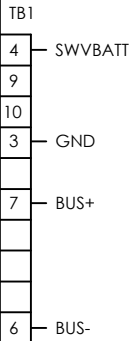
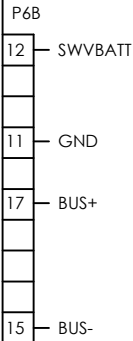
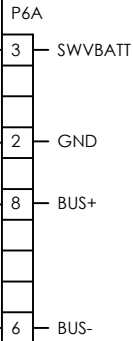
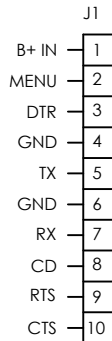

USE CABLE NO.  
2100759-004 PRE-SPLICED  
OR  
2100759-001  
2100759-007 (6895)

USE CABLE NO.  
2100759-004

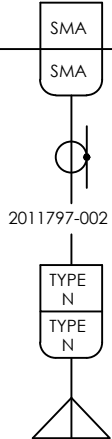

SCALE	SIZE	DOC TYPE	DRAWING NO.	REV	SHEET
NONE	B	WI	2100527	AT	7 OF

FREEWAVE  
RADIO  
FGR09CSU  
FGRIO-M/S 4

FGR2-C-U  
LRS455-C-U

RS485  
OPERATION

MODEL

ELEK PCBA

TERM PCBA

COMM

I/O OPTION  
PCBA

LMC7100  
6790

2101210-XXX

1

LMC7100  
6790

2101210-XXX

2

66XX FCU 3

2000028-XXX  
2010020-XXX  
2010054-XXX  
2010282-XXX  
2011772-XXX  
2012803-XXX

2010232-XXX

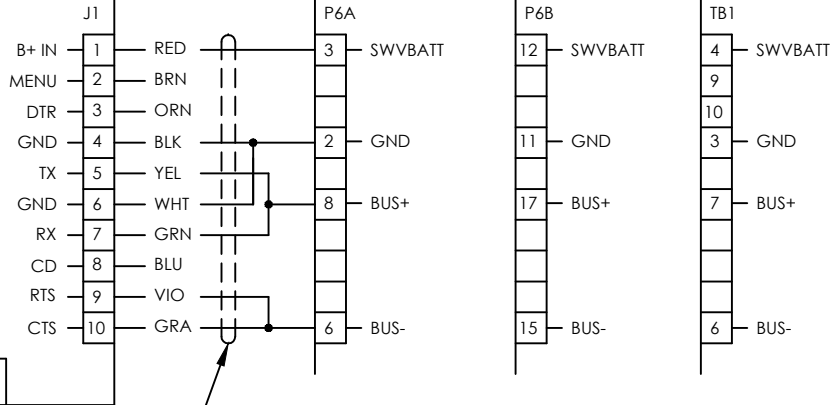

USE CABLE NO.  
2100759-004 PRE-SPLICED  
OR  
2100759-001

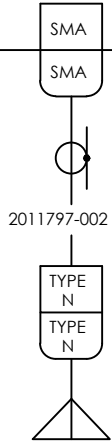

2011797-002

SCALE	SIZE	DOC TYPE	DRAWING NO.	REV	SHEET
NONE	B	WI	2100527	AT	8 OF