

$V_{RSM}$	=	5500 V
$I_{F(AV)M}$	=	3480 A
$I_{F(RMS)}$	=	5470 A
$I_{FSM}$	=	$46 \times 10^3$ A
$V_{F0}$	=	0.94 V
$r_F$	=	0.147 m $\Omega$

# Rectifier Diode

## 5SDD 33L5500

Doc. No. 5SYA1168-01 Apr 13

- Patented free-floating silicon technology
- Very low on-state losses
- Optimum power handling capability

### Blocking

Maximum rated values <sup>1)</sup>

Parameter	Symbol	Conditions	Value	Unit
Max repetitive peak reverse voltage	$V_{RRM}$	$f = 50$ Hz, $t_p = 10$ ms, $T_{vj} = 0 \dots 150$ °C	5000	V
Max non-repetitive peak reverse voltage	$V_{RSM}$	$f = 5$ Hz, $t_p = 10$ ms, $T_{vj} = 0 \dots 150$ °C	5500	V

Characteristic values

Parameter	Symbol	Conditions	min	typ	max	Unit
Reverse leakage current	$I_{RRM}$	$V_{RRM}$ , $T_{vj} = 150$ °C			400	mA

### Mechanical data

Maximum rated values <sup>1)</sup>

Parameter	Symbol	Conditions	min	typ	max	Unit
Mounting force	$F_M$		63	70	77	kN
Acceleration	a	Device unclamped			50	m/s <sup>2</sup>
Acceleration	a	Device clamped			100	m/s <sup>2</sup>

Characteristic values

Parameter	Symbol	Conditions	min	typ	max	Unit
Weight	m				1.45	kg
Housing thickness	H	$F_M = 70$ kN, $T_a = 25$ °C	25.9		26.6	mm
Surface creepage distance	$D_S$		35			mm
Air strike distance	$D_a$		14			mm

1) Maximum rated values indicate limits beyond which damage to the device may occur

ABB Switzerland Ltd, Semiconductors reserves the right to change specifications without notice.



## On-state

### Maximum rated values <sup>1)</sup>

Parameter	Symbol	Conditions	min	typ	max	Unit
Average on-state current	$I_{F(AV)M}$	50 Hz, Half sine wave, $T_C = 90\text{ °C}$			3480	A
RMS on-state current	$I_{F(RMS)}$				5470	A
Peak non-repetitive surge current	$I_{FSM}$	$t_p = 10\text{ ms}$ , $T_{vj} = 150\text{ °C}$ , sine half wave, $V_R = 0\text{ V}$ , after surge			$46 \times 10^3$	A
Limiting load integral	$I^2t$		$10.6 \times 10^6$			$A^2s$
Peak non-repetitive surge current	$I_{FSM}$	$t_p = 10\text{ ms}$ , $T_{vj} = 150\text{ °C}$ , sine half wave, $V_R = 0.6 \cdot V_{RRM1}$ , after surge				A
Limiting load integral	$I^2t$					$A^2s$

### Characteristic values

Parameter	Symbol	Conditions	min	typ	max	Unit
On-state voltage	$V_F$	$I_F = 5000\text{ A}$ , $T_{vj} = 150\text{ °C}$			1.68	V
Threshold voltage	$V_{F0}$	$T_{vj} = 150\text{ °C}$ $I_T = 3000 \dots 8000\text{ A}$			0.94	V
Slope resistance	$r_F$		0.147			$m\Omega$

## Switching

### Characteristic values

Parameter	Symbol	Conditions	min	typ	max	Unit
Reverse recovery charge	$Q_{rr}$	$di_F/dt = -10\text{ A}/\mu s$ , $V_R = 200\text{ V}$ $I_F = 4000\text{ A}$ , $T_{vj} = 150\text{ °C}$			10000	$\mu As$
Reverse recovery current	$I_{RM}$		340			A

# Thermal

Maximum rated values <sup>1)</sup>

Parameter	Symbol	Conditions	min	typ	max	Unit
Operating junction temperature range	T <sub>vj</sub>		0		150	°C
Storage temperature range	T <sub>stg</sub>		-40		150	°C

## Characteristic values

Parameter	Symbol	Conditions	min	typ	max	Unit
Thermal resistance junction to case	R <sub>th(j-c)</sub>	Double-side cooled F <sub>m</sub> = 63...77 kN			7	K/kW
	R <sub>th(j-c)A</sub>	Anode-side cooled F <sub>m</sub> = 63...77 kN			14	K/kW
	R <sub>th(j-c)C</sub>	Cathode-side cooled F <sub>m</sub> = 63...77 kN			14	K/kW
Thermal resistance case to heatsink	R <sub>th(c-h)</sub>	Double-side cooled F <sub>m</sub> = 63...77 kN			1.5	K/kW
	R <sub>th(c-h)</sub>	Single-side cooled F <sub>m</sub> = 63...77 kN			3	K/kW

Analytical function for transient thermal impedance:

$$Z_{th(j-c)}(t) = \sum_{i=1}^n R_{th i} (1 - e^{-t/\tau_i})$$

i	1	2	3	4
R <sub>th i</sub> (K/kW)	4.700	0.853	1.070	0.490
τ <sub>i</sub> (s)	0.5506	0.0790	0.0107	0.0028

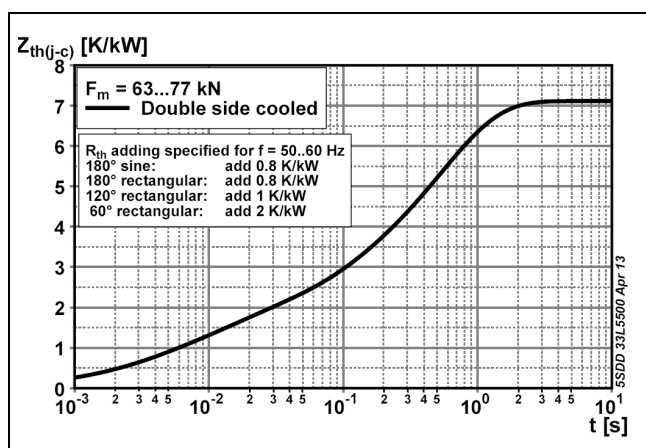

Fig. 1 Transient thermal impedance (junction-to-case) vs. time

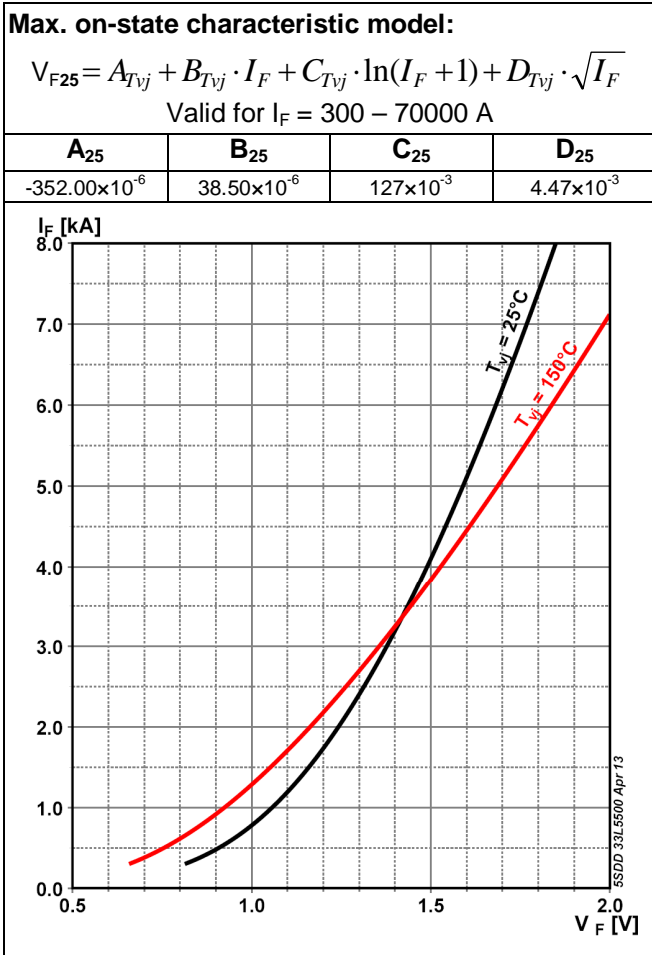

Fig. 2 On-state voltage characteristics

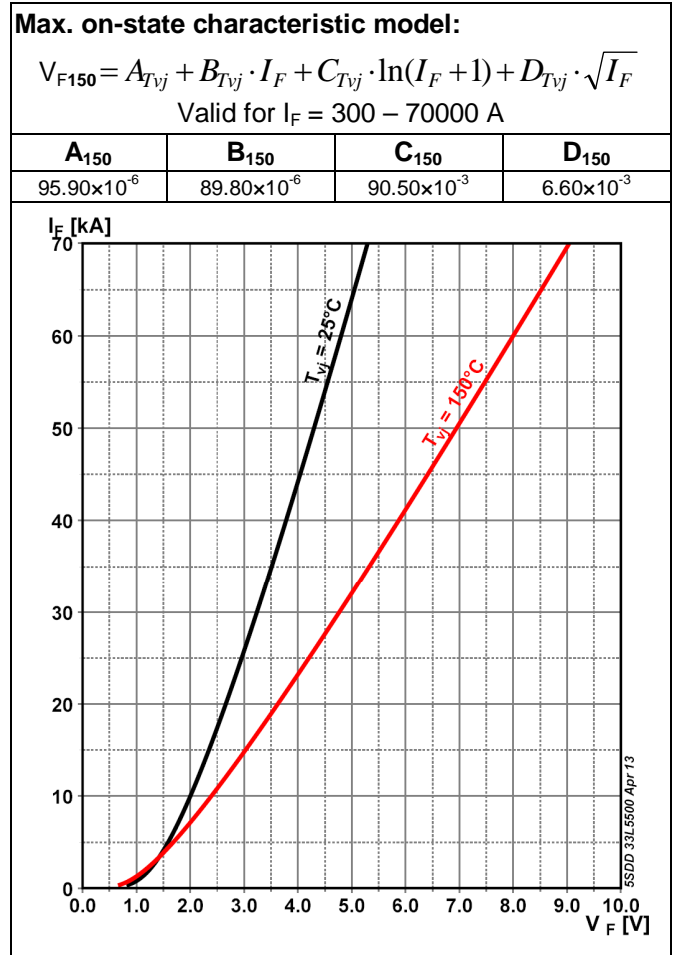

Fig. 3 On-state voltage characteristics

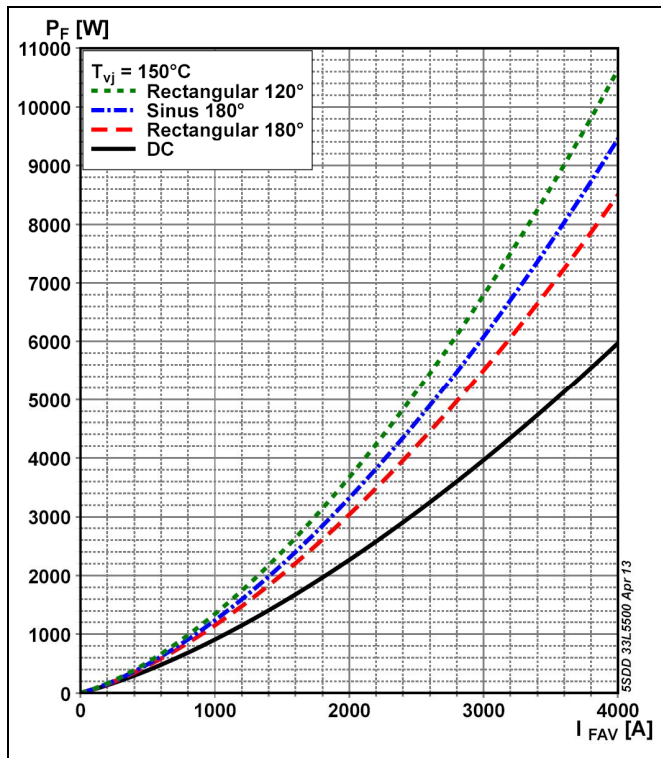

Fig. 4 On-state power dissipation vs. mean on-state current

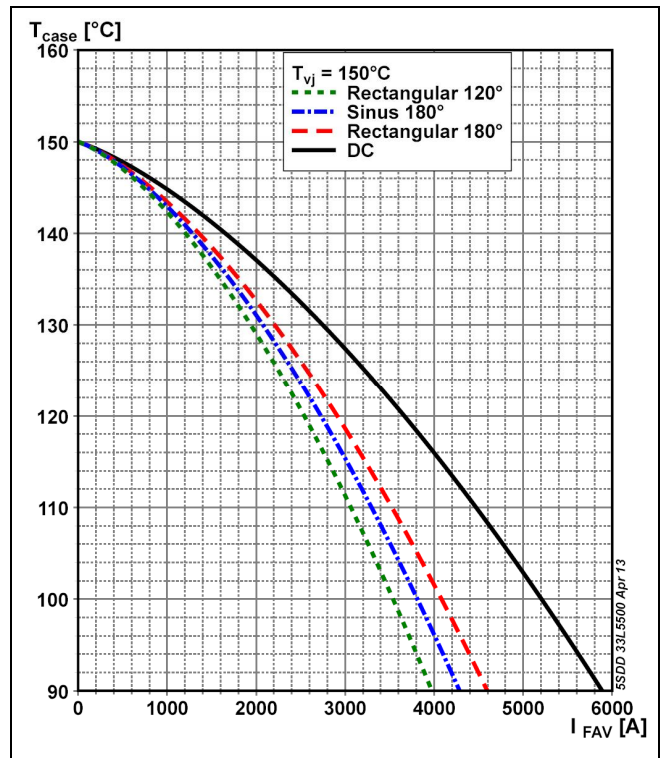

Fig. 5 Max. permissible case temperature vs. mean on-state current

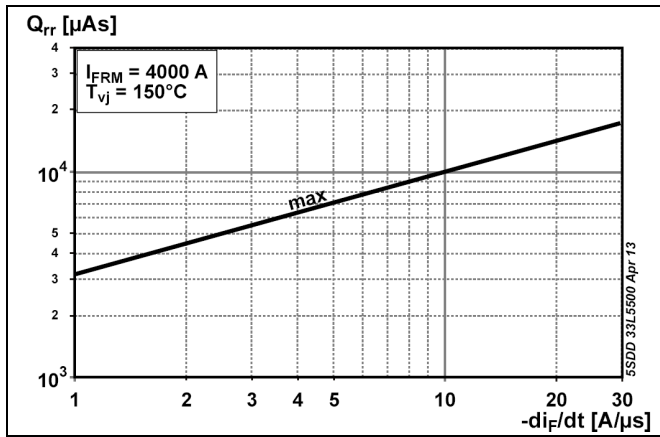

Fig. 6 Reverse recovery charge vs. decay rate of on-state current

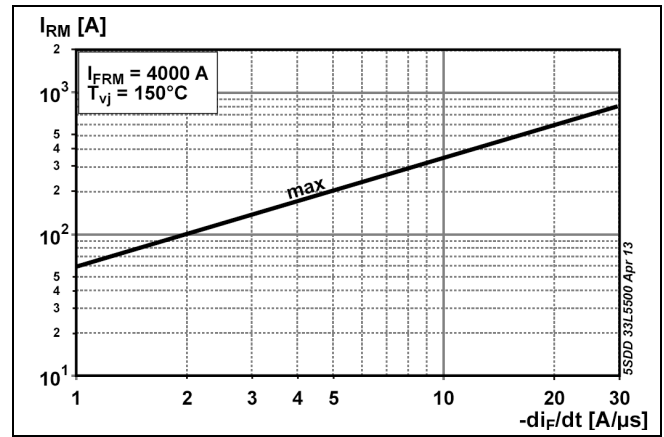
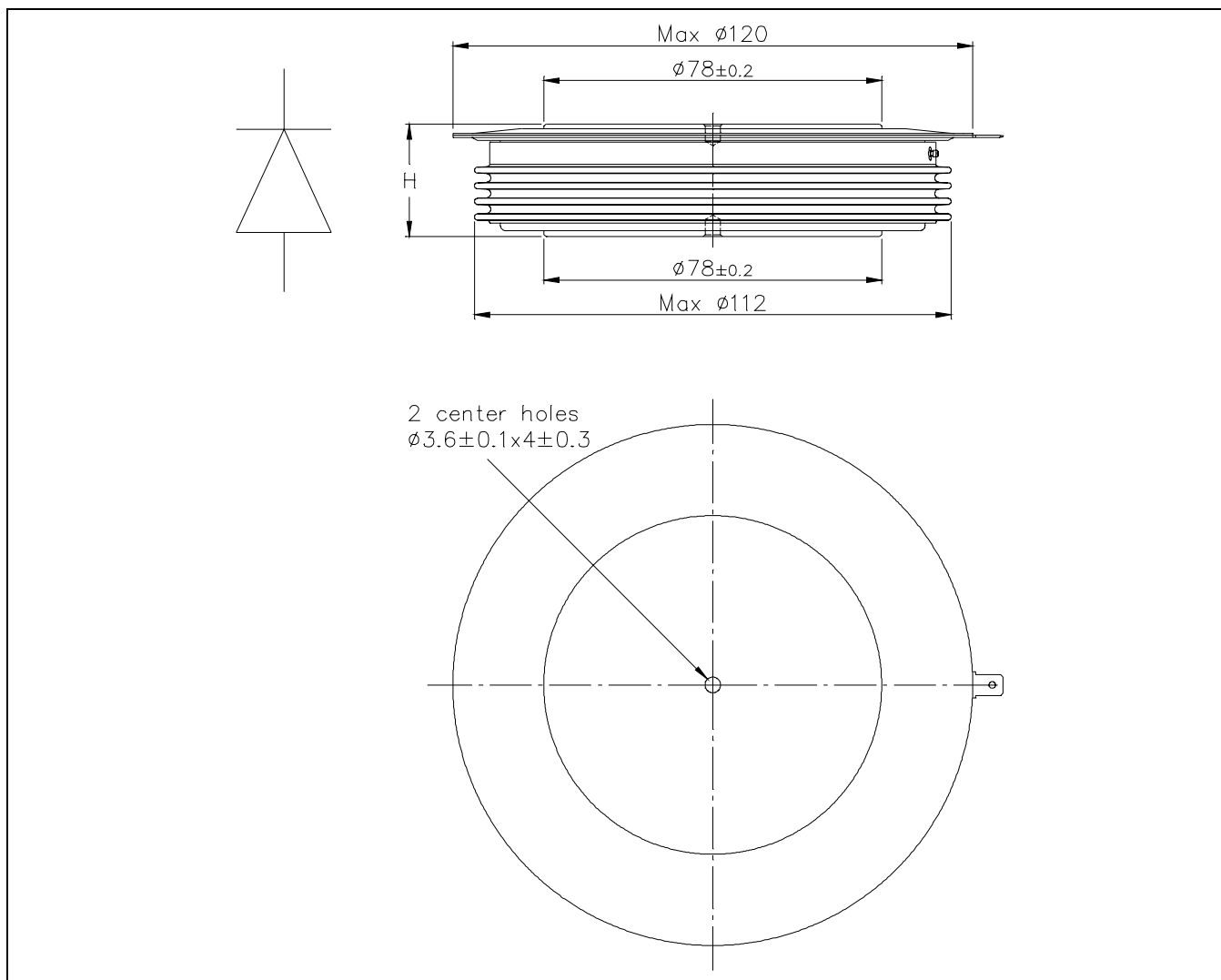

Fig. 7 Peak reverse recovery current vs. decay rate of on-state current



**Fig. 8** Device Outline Drawing

### Related documents:

5SYA 2020	Design of RC-Snubbers for Phase Control Applications
5SYA 2029	High Power Rectifier Diodes
5SYA 2036	Recommendations regarding mechanical clamping of Press Pack High Power Semiconductors
5SYA 2048	Field Measurements on High Power Press-Pack Semiconductors
5SYA 2051	Voltage Ratings of High Power Semiconductors
5SZK 9104	Specification of environmental class for pressure contact diodes, PCTs and GTO, Storage
5SZK 9105	Specification of environmental class for pressure contact diodes, PCTs and GTO, Transportation
5SZK 9115	Specification of environmental class for presspack Diodes, PCTs and GTOs, Operation (Industry)
5SZK 9116	Specification of environmental class for presspack Diodes, PCTs and GTOs, Operation (Traction)

Please refer to <http://www.abb.com/semiconductors> for current version of documents.

**ABB Switzerland Ltd, Semiconductors reserves the right to change specifications without notice.**



**ABB Switzerland Ltd**  
**Semiconductors**  
 Fabrikstrasse 3  
 CH-5600 Lenzburg, Switzerland

Doc. No. 5SYA1168-01 Apr 13

Telephone +41 (0)58 586 1419  
 Fax +41 (0)58 586 1306  
 Email [abbsem@ch.abb.com](mailto:abbsem@ch.abb.com)  
 Internet [www.abb.com/semiconductors](http://www.abb.com/semiconductors)